

---

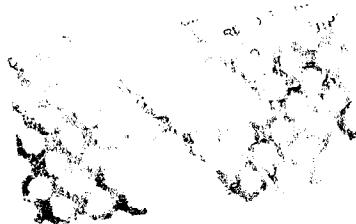
---

# HP 3457A Multimeter

## Operating Manual

HEWLETT-PACKARD COMPANY

Loveland Instrument Division  
P.O. Box 301  
Loveland, Colorado 80537



MANUAL PART NO. 03457-90003  
MICROFICHE PART NO. 03457-90053  
Printed in U.S.A. May 1986

**NOTICE**

The information contained in this document is subject to change without notice.

HEWLETT-PACKARD MAKES NO WARRANTY OF ANY KIND WITH REGARD TO THIS MATERIAL, INCLUDING, BUT NOT LIMITED TO, THE IMPLIED WARRANTIES OF MERCHANTABILITY AND FITNESS FOR A PARTICULAR PURPOSE. Hewlett-Packard shall not be liable for errors contained herein or for incidental or consequential damages in connection with the furnishing, performance or use of this material.

Hewlett-Packard assumes no responsibility for the use or reliability of its software on equipment that is not furnished by Hewlett-Packard.

This document contains proprietary information which is protected by copyright. All rights are reserved. No part of this document may be photocopied, reproduced or translated to another language without the prior written consent of Hewlett-Packard Company.



### **CERTIFICATION**

*Hewlett-Packard Company certifies that this product met its published specifications at the time of shipment from the factory. Hewlett-Packard further certifies that its calibration measurements are traceable to the United States National Bureau of Standards, to the extent allowed by the Bureau's calibration facility, and to the calibration facilities of other International Standards Organization members.*

### **WARRANTY**

This Hewlett-Packard instrument product is warranted against defects in materials and workmanship for a period of one year from date of shipment. During the warranty period, Hewlett-Packard Company will, at its option, either repair or replace products which prove to be defective.

For warranty service or repair, this product must be returned to a service facility designated by -hp-. Buyer shall prepay shipping charges to -hp- and -hp- shall pay shipping charges to return the product to Buyer. However, Buyer shall pay all shipping charges, duties, and taxes for products returned to -hp- from another country.

Duration and conditions of warranty for this instrument may be superceded when the instrument is integrated into (becomes a part of) other -hp- instrument products.

Hewlett-Packard warrants that its software and firmware designated by -hp- for use with an instrument will execute its programming instructions when properly installed on that instrument. Hewlett-Packard does not warrant that the operation of the instrument, or software, or firmware will be uninterrupted or error free.

### **LIMITATION OF WARRANTY**

The foregoing warranty shall not apply to defects resulting from improper or inadequate maintenance by Buyer, Buyer-supplied software or interfacing, unauthorized modification or misuse, operation outside of the environmental specifications for the product, or improper site preparation or maintenance.

**NO OTHER WARRANTY IS EXPRESSED OR IMPLIED. HEWLETT-PACKARD SPECIFICALLY DISCLAIMS THE IMPLIED WARRANTIES OF MERCHANTABILITY AND FITNESS FOR A PARTICULAR PURPOSE.**

### **EXCLUSIVE REMEDIES**

**THE REMEDIES PROVIDED HEREIN ARE BUYER'S SOLE AND EXCLUSIVE REMEDIES. HEWLETT-PACKARD SHALL NOT BE LIABLE FOR ANY DIRECT, INDIRECT, SPECIAL, INCIDENTAL, OR CONSEQUENTIAL DAMAGES, WHETHER BASED ON CONTRACT, TORT, OR ANY OTHER LEGAL THEORY.**

### **ASSISTANCE**

*Product maintenance agreements and other customer assistance agreements are available for Hewlett-Packard products.*

*For any assistance, contact your nearest Hewlett-Packard Sales and Service Office. Addresses are provided at the back of this manual.*



## **SAFETY SUMMARY**

The following general safety precautions must be observed during all phases of operation, service, and repair of this instrument. Failure to comply with these precautions or with specific warnings elsewhere in this manual violates safety standards of design, manufacture, and intended use of the instrument. Hewlett-Packard Company assumes no liability for the customer's failure to comply with these requirements.

### **GROUND THE INSTRUMENT**

To minimize shock hazard, the instrument chassis and cabinet must be connected to an electrical ground.

### **DO NOT OPERATE IN AN EXPLOSIVE ATMOSPHERE**

Do not operate the instrument in the presence of flammable gases or fumes. Operation of any electrical instrument in such an environment constitutes a definite safety hazard.

### **KEEP AWAY FROM LIVE CIRCUITS**

Operating personnel must not remove instrument covers. Component replacement and internal adjustments must be made by qualified maintenance personnel. Under certain conditions, dangerous voltages may exist even with the instrument switched off. To avoid injuries, always disconnect input voltages and discharge circuits before touching them.

### **DO NOT SERVICE OR ADJUST ALONE**

Do not attempt internal service or adjustment unless another person, capable of rendering first aid and resuscitation, is present.

### **DO NOT SUBSTITUTE PARTS OR MODIFY INSTRUMENT**

Because of the danger of introducing additional hazards, do not install substitute parts or perform any unauthorized modification to the instrument. Return the instrument to a Hewlett-Packard Sales and Service Office for service and repair to ensure that safety features are maintained.

### **DO NOT OPERATE A DAMAGED INSTRUMENT**

Whenever it is possible that the safety protection features built into this instrument have been impaired, either through physical damage, excessive moisture, or any other reason, REMOVE POWER and do not use the instrument until safe operation can be verified by service-trained personnel. If necessary, return the instrument to a Hewlett-Packard Sales and Service Office for service and repair to ensure that safety features are maintained.

# Operating and Safety Symbols

## Symbols Used On Products And In Manuals

~ LINE AC line voltage input receptacle.



Instruction manual symbol affixed to product. Cautions the user to refer to respective instruction manual procedures to avoid possible damage to the product.



Indicates dangerous voltage – terminals connected to interior voltage exceeding 1000 volts.



OR



Protective conductor terminal. Indicates the field wiring terminal that must be connected to earth ground before operating equipment – protects against electrical shock in case of fault.



Clean ground (low-noise). Indicates terminal that must be connected to earth ground before operating equipment – for single common connections and protection against electrical shock in case of fault.



OR



Frame or chassis ground. Indicates equipment chassis ground terminal – normally connects to equipment frame and all metal parts.



Affixed to product containing static sensitive devices – use anti-static handling procedures to prevent electrostatic discharge damage to components.

---

### NOTE

#### NOTE

*Calls attention to a procedure, practice, or condition that requires special attention by the reader.*

---

---

### CAUTION

#### CAUTION

*Calls attention to a procedure, practice, or condition that could possibly cause damage to equipment or permanent loss of data.*

---

---

### WARNING

#### WARNING

*Calls attention to a procedure, practice, or condition that could possibly cause bodily injury or death.*

---



# 3457A-2A SERVICE NOTE

SUPERSEDES  
3457A-2

## HP MODEL 3457A DIGITAL MULTIMETER

03457-66501 — ERC Below 2609  
S/N 2538A01301 and BELOW

### ENHANCING THE DIGITAL BOARD

If your HP 3457A Digital Multimeter is experiencing any of the symptoms listed below, order service kit 03457-68701 and follow the modification procedure given in this service note.

1. Invalid reading when using the dBm math function.
2. Incorrect "trigger too fast" error when using the TIMER command.
3. Incorrect "trigger too fast" error when externally triggering the HP 3457A with the HP 3497A external increment signal.
4. Incorrect "trigger too fast" error when using external trigger from program memory.

#### MODIFICATION PROCEDURE



*The battery on the A1 Digital Assembly, A1BT501, is easily shorted. Shorting this battery causes the loss of all calibration constants. This board should NEVER be placed flat on any surface with its circuit side down.*

1. Follow the disassembly procedures listed in the HP 3457A Service Manual P/N 03457-90010 Section VI for Top Cover Removal and Digital (A1) Assembly removal.
2. Once the 03457-66501 assembly is removed, find the ROM (A1U502) shown in figure 1.

D/OF/WA expires 11/87

02/86-09/TKC

Printed in U.S.A.



3457A-2A



FOR MORE INFORMATION, CALL YOUR LOCAL HP SALES OR SERVICE OFFICE or East (201) 265-5000 • Midwest (312) 255-9800 • South (404) 955-1500 • West (213) 970-7500 or (415) 968-9200; OR WRITE, Hewlett-Packard, 1820 Embarcadero, Palo Alto, California 94303. IN EUROPE, CALL YOUR LOCAL HP SALES OR SERVICE OFFICE OR WRITE, Hewlett-Packard S.A., 7, rue du Bois-du-Lan Case Postale 365 CH-1217 MEYRIN 1 - Geneva, Switzerland. IN JAPAN, Yokogawa-Hewlett-Packard Ltd., 1-27-15, Yabe Sagamihara City, Kanagawa Prefecture, Japan 229.

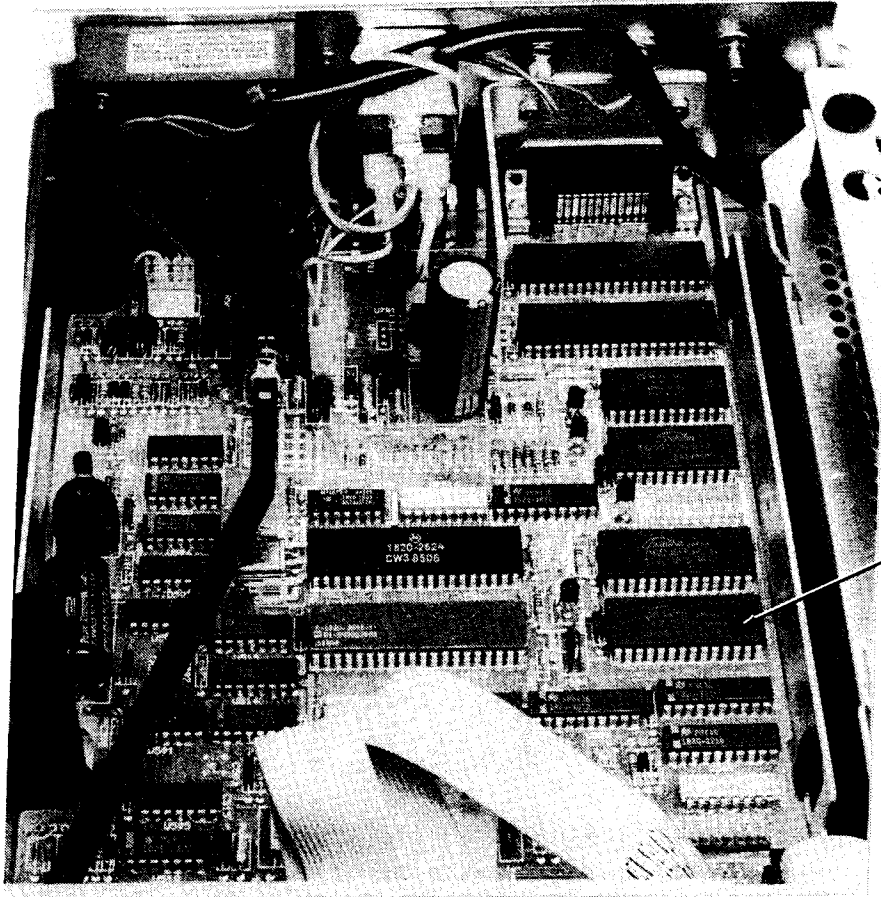


Figure 1.

3. Remove and discard the ROM.
4. Add the socket P/N 1200-0861.
5. Place the EPROM (P/N 03457-88804) into the socket.
6. Return the board to its proper position in the instrument, again following the procedure listed in Section VI of the Service Manual.

To verify operation, follow the procedure for operation verification given in the Service Manual (P/N 03457-90010). This modification will take a maximum of two hours.



# Preface

This is your operating manual for the HP 3457 Multimeter and its optional plug-in cards (HP 44491 and 44492). This manual contains installation, operating, and configuration (wiring) information consisting of the following five chapters:

## **Chapter 1 Meet the HP 3457**

Chapter 1 contains the most fundamental information concerning the HP 3457. This includes a brief description of the HP 3457 and its options, installation information, specifications, and photographs showing keys, switches and connectors.

## **Chapter 2 How to Operate Your HP 3457**

Chapter 2 contains introductory operating information. Using this chapter, you will become familiar with the HP 3457 front panel functions and learn the equivalent HP-IB commands. This chapter prepares you to use Chapters 3 and 4 (and possibly Chapter 5) to solve your particular measurement tasks.

## **Chapter 3 Functions and Features**

Chapter 3 describes the HP 3457's capabilities and features such as DC voltage measurements, 4-wire ohms, triggering, buffers, and math operations. You should use this chapter as the first step towards solving a particular measurement task. For example, suppose you want to make AC voltage measurements, use external triggering, and store the results in reading memory. You will find each of these tasks in Chapter 3. Under each task is a general overview of the task and a summary of the commands you need to use. You can then proceed to Chapter 4 to find the details concerning each command.

## **Chapter 4 Command Reference**

Chapter 4 describes the details concerning the commands for the HP 3457 and its optional plug-in cards. Commands are categorized in alphabetical order. Since this chapter is a reference, command discussions are terse and to the point. Example command statements and programs are in BASIC language.

## **Chapter 5 Plug-In Cards**

Chapter 5 contains specific information concerning the optional plug-in cards. This includes installation, programming commands, wiring, and configuration information.

## **Related Documentation**

The HP 3457A Quick Reference Guide (Part Number 03457-90004) is a summary of the operating information in this manual.

The HP 3457A Service Manual contains calibration, performance test, and repair information for the HP 3457.



## Contents

### Chapter 1 Meet the HP 3457

Introduction	1-1
An Overview of the HP 3457	1-1
Initial Inspection	1-2
Installing Your HP 3457	1-3
Maintenance	1-9
Abbreviated Specifications	1-11
Options and Accessories	1-16

### Chapter 2 How to Operate Your HP 3457

Introduction	2-1
Before Applying Power	2-1
Applying Power	2-1
Operating From the Front Panel	2-3
Operating from Remote	2-32
Often-Used Commands	2-36
Additional Functions	2-43

### Chapter 3 Functions and Features

Introduction	3-1
Input Terminals	3-1
Plug-In Cards	3-2
Measurements in General	3-4
Predefined States	3-6
Voltage Measurements	3-8
Resistance Measurements	3-12
Current Measurements	3-17
Frequency and Period Measurements	3-20
Math Operations	3-22
Buffers	3-28
Memories	3-34
Triggering	3-40

Maximizing Throughput	3-50
Self-Tests	3-50
Calibration	3-51
The Status Register	3-52
The Error Register	3-54
The Auxiliary Error Register	3-55
The Front Panel	3-56
HP-IB Address	3-58
Identity	3-58
Beeps and Tones	3-59

### Chapter 4 Command Reference

Introduction	4-1
Reading a Syntax Diagram	4-2
Language Conventions	4-3
(Commands listed in alphabetical order)	4-7 – 4-165

#### HP-IB Commands

Introduction	4-167
ABORTIO 7 (IFC)	4-168
CLEAR (DCL or SDC)	4-169
LOCAL (GTL)	4-170
LOCAL LOCKOUT (LLO)	4-171
REMOTE	4-172
SROLL (Serial Poll)	4-173
TRIGGER (GET)	4-174

### Chapter 5 Plug-In Cards

Introduction	5-1
Installing a Plug-In Card	5-1
The HP 44491 Armature Relay Multiplexer Card	5-8
The HP 44492 Reed Relay Multiplexer Card	5-28

## List of Tables

	Page		Page		
Table 1-1.	Line Voltage Limits.....	1-4	Table 3-7.	Maximum Offset Voltages.....	3-16
Table 1-2.	HP-IB Address Codes.....	1-6	Table 3-8.	DCI Range vs. Resolution.....	3-18
Table 1-3.	Replacement Power Line Fuses and Caps.....	1-9	Table 3-9.	ACI and AC+DCI Range vs. Resolution.....	3-19
Table 1-4.	HP 3457 Specifications.....	1-11	Table 3-10.	STAT Registers.....	3-27
Table 1-5.	Options.....	1-16	Table 3-11.	SINT Scale Factors.....	3-30
Table 1-6.	Accessories.....	1-16	Table 3-12.	DINT Scale Factors.....	3-31
Table 3-1.	A/D Converter Relationships.....	3-5	Table 3-13.	SINT Scale Factors.....	3-35
Table 3-2.	Power-on, Reset, and Preset States..	3-7	Table 3-14.	DINT Scale Factors.....	3-36
Table 3-3.	DCV Range vs. Resolution.....	3-9	Table 3-15.	Default Delay Times.....	3-44
Table 3-4.	Input Impedances.....	3-9	Table 3-16.	Added Delay for Range Change....	3-44
Table 3-5.	AC or AC+DC Voltage Range vs. Resolution.....	3-10	Table 3-17.	Added Delay for Function Change.	3-45
Table 3-6.	Range vs. Resolution and Current Sourced.....	3-12	Table 5-1.	HP 44491A Specifications.....	5-27
			Table 5-2.	HP 44492A Specifications.....	5-36

## List of Illustrations

	Page		Page		
Figure 1-1.	Shipping Contents.....	1-2	Figure 3-8.	Timer/Delay Sequence.....	3-43
Figure 1-2.	AC Line Voltage Switch Positions...	1-4	Figure 5-1.	Disconnecting the Wiring Harness...	5-3
Figure 1-3.	Line Power Fuse Holder.....	1-5	Figure 5-2.	Connecting the Wiring Harness.....	5-3
Figure 1-4.	Typical HP-IB Interconnection.....	1-5	Figure 5-3.	Inserting a Plug-In Card.....	5-4
Figure 1-5.	Rear Terminal Current Fuse.....	1-10	Figure 5-4.	Connecting a Wire to the Wiring Block.....	5-5
Figure 2-1.	SMPL Annunciator.....	2-2	Figure 5-5.	Assembling Wiring Block/Strain Relief.....	5-5
Figure 2-2.	Standard 2-Wire Measurements.....	2-6	Figure 5-6.	Strain Relief Housing/Plate Assembly.....	5-6
Figure 2-3.	Current Measurements.....	2-8	Figure 5-7.	Installing the Strain Relief/Wiring Block.....	5-7
Figure 2-4.	4-Wire Ohms Measurements.....	2-10	Figure 5-8.	2-Wire Channels.....	5-9
Figure 2-5.	Configuration Keys.....	2-12	Figure 5-9.	4-Wire Channels.....	5-9
Figure 2-6.	Math Keys.....	2-24	Figure 5-10.	Wiring Block.....	5-10
Figure 2-7.	Rear Terminal Connections.....	2-43	Figure 5-11.	2-Wire Measurements Example....	5-21
Figure 3-1.	Measurement Terminals.....	3-2	Figure 5-12.	4-Wire Measurements Example....	5-22
Figure 3-2.	Voltage Measurement Connections..	3-8	Figure 5-13.	Actuator Switching Low Voltage...	5-23
Figure 3-3.	2-Wire Ohms Measurement Connections.....	3-13	Figure 5-14.	Actuator Switching Line Voltage...	5-23
Figure 3-4.	4-Wire Ohms Measurement Connections.....	3-15	Figure 5-15.	Contact Protection Network.....	5-24
Figure 3-5.	Current Measurement Connections.	3-17	Figure 5-16.	Added Networks.....	5-26
Figure 3-6.	Frequency and Period Measurement Connections.....	3-20	Figure 5-17.	Current Fuse Locations.....	5-26
Figure 3-7.	Rear Panel External Trigger Terminal.....	3-41	Figure 5-18.	Wiring Block.....	5-28
			Figure 5-19.	2-Wire Measurement Example....	5-36

# CONTENTS

	Page
Introduction.....	1-1
An Overview of the HP 3457.....	1-1
Plug-In Cards.....	1-2
The HP 44491.....	1-2
The HP 44492.....	1-2
Initial Inspection.....	1-2
Installing Your HP 3457.....	1-3
Grounding Requirements.....	1-3
AC Line Power Requirements.....	1-3
Setting the Line Voltage Switches.....	1-4
Installing the Line Power Fuse.....	1-4
Connecting the HP-IB Interface.....	1-5
Specifying the HP-IB Address.....	1-6
Mounting the HP 3457.....	1-6
Operating the HP 3457.....	1-6
Maintenance.....	1-9
Replacing Fuses.....	1-9
Line Power Fuse.....	1-9
Front Terminal Current Fuse.....	1-9
△Rear Terminal Current Fuse.....	1-10
How to Obtain Repair Service.....	1-10
Serial Number.....	1-10
General Shipping Instructions.....	1-11
Abbreviated Specifications.....	1-11
Options and Accessories.....	1-16



# Meet the HP 3457

---

## Introduction

This chapter contains an introduction to the HP 3457, unpacking information, and instructions on how to install and apply power to the HP 3457. It also contains maintenance information, specifications, and listings of the HP 3457's available options and accessories. It's a good idea to completely read through the installation information before making any electrical connections or attempting to operate the HP 3457.

---

### WARNING

*If any of the following symptoms exist, or are even suspected, remove the HP 3457 from service. Do not use the HP 3457 until safe operation can be verified by service trained personnel.*

- 1. Visible damage.*
- 2. Severe transport stress.*
- 3. Prolonged storage under adverse conditions.*
- 4. Failure to perform intended measurements or functions.*

*If necessary, return the HP 3457 to a Hewlett-Packard Sales and Service Office for service and repair to ensure that safety features are maintained.*

---

## An Overview of the HP 3457

Your HP 3457 is a very versatile multimeter for both system (HP-IB)\* and bench applications. It can measure DC voltage, AC voltage, AC + DC voltage, DC current, AC current, AC + DC current, 2- & 4-wire ohms, frequency, and period. In addition, the HP 3457 has reading and program storage and is capable of making very fast measurements.

\*The Hewlett-Packard Interface Bus (HP-IB) is Hewlett-Packard's implementation of IEEE Standard 488-1978 and ANSI MC1.1.

## Plug-In Cards

Two optional plug-in cards are available for the HP 3457; the HP 44491 Armature Relay Multiplexer, and the HP 44492 Reed Relay Multiplexer.

---

### WARNING

*In case of component failure, any voltage input to an optional plug-in card may be present on any other terminal on the same optional plug-in card.*

---

- The HP 44491** The HP 44491 Armature Relay Multiplexer Card can be automatically configured into eight 2-wire input channels, four 4-wire input channels, or a combination of 2- and 4-wire channels. In addition, this card has two 2-wire channels that you can use as current inputs or actuator outputs.
- The HP 44492** The HP 44492 Reed Relay Multiplexer Card can be thought of as a ten channel extension of the HP 3457's input terminals. You can use the HP 44492 as the HP 3457's input source for standard 2-wire DC voltage, AC voltage, AC + DC voltage, resistance, frequency and period measurements. You cannot use the HP 44492 for 4-wire ohms or for measuring any type of current.

The HP 44492 has ten 2-wire channels numbered 0 through 9. All channels are *break-before-make*. That is, the HP 3457 disconnects the present channel before it connects the next channel.

## Initial Inspection

When you receive your HP 3457, verify that the items shown in Figure 1-1 are included.

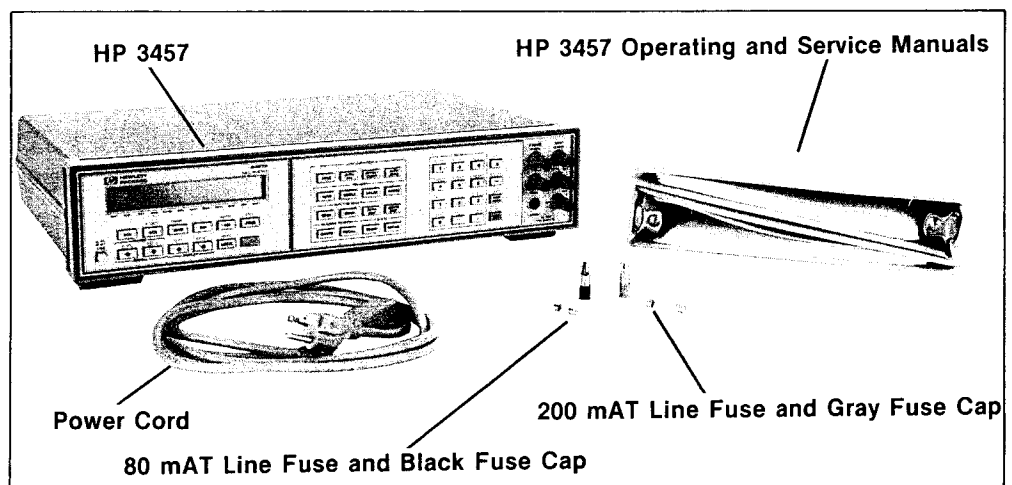


Figure 1-1. Equipment Supplied



Your HP 3457 was carefully inspected before it left the factory. It should be free of marks or scratches and in proper working order upon receipt. You should, however, inspect the HP 3457 for any damage that may have occurred in transit.

If the shipping container or cushioning material is damaged, keep it until the contents of the shipment have been checked and the HP 3457 has been inspected for mechanical and electrical damage. The HP 3457 Service Manual contains procedures for checking the electrical performance of the HP 3457. If there is any mechanical damage, the contents are incomplete, or the HP 3457 fails to pass its Operation Verification or Performance Tests, promptly notify the nearest Hewlett-Packard office. A list of the HP Sales and Service Offices is located in the back of this manual.

## Installing Your HP 3457

This section discusses the HP 3457's power requirements and contains instructions for installing your HP 3457. If you ordered an optional plug-in card, you should install it before you install the HP 3457. Instructions for service trained personnel to install and configure an optional plug-in card are in Chapter 5 of this manual.

### Grounding Requirements

The HP 3457 comes with a three conductor AC power cable. The power cable must either be plugged into an approved three-contact electrical outlet or used with a three-contact or two-contact adapter with the grounding wire (green) connected to an electrical ground (safety ground). The HP 3457's power jack and the supplied power cable meet International Electrotechnical Commission (IEC) safety standards.

### AC Line Power Requirements

You can operate the HP 3457 from a single-phase power source delivering either 100 VAC, 120 VAC, 220 VAC, or 240 VAC (all values RMS), at 48 to 66 Hz. The line power voltage can vary by  $\pm 10\%$  but cannot exceed 250 VAC RMS. Maximum power consumption is 30 VA (Volt-Amps). The nominal line voltage values and their corresponding limits are shown in Table 1-1.

---

#### CAUTION

*Before connecting the HP 3457 to an AC power source, verify that the AC power source matches the setting of the HP 3457's line voltage selection switches and that the proper fuse is installed.*

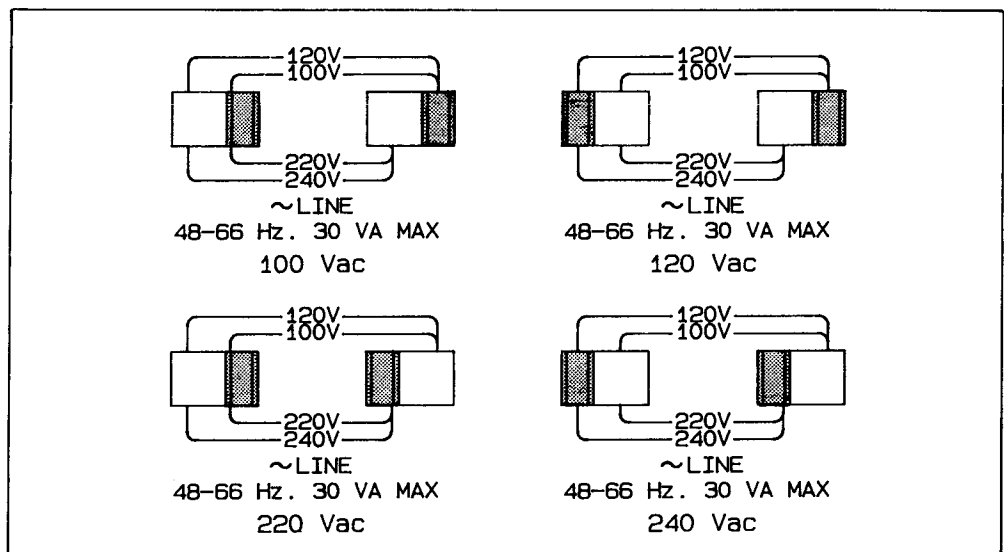
---

**Table 1-1. Line Voltage Limits**

Nominal Value (RMS)	Allowable Limits (RMS)
100 VAC	90 VAC to 110 VAC
120 VAC	108 VAC to 132 VAC
220 VAC	198 VAC to 242 VAC
240 VAC	216 VAC to 250 VAC

## Setting the Line Voltage Switches

If you need to change the positions of the AC line voltage selection switches, turn the HP 3457's power off and remove its power cord. With a small flatblade screwdriver, move the switches to the appropriate positions as shown in Figure 1-2.



**Figure 1-2. AC Line Voltage Switch Positions**

## Installing the Line Power Fuse

The HP 3457 *does not* have a line power fuse installed when shipped from the factory. Instead, two line power fuses and caps (packaged in plastic bags) are provided with your HP 3457. You must install the appropriate fuse and fuse cap. For 100 VAC or 120 VAC operation install the 200 mA fuse and the gray fuse cap. For 220 VAC or 240 VAC operation install the 80 mA fuse and the black fuse cap.

The line power fuse holder is located on the right side of the HP 3457's rear panel (see Figure 1-3). To install a fuse, insert one end of the fuse into the fuse cap. Insert the fuse/cap assembly into the fuse holder. With a small flatblade screwdriver, push in on the fuse cap and rotate it clockwise.

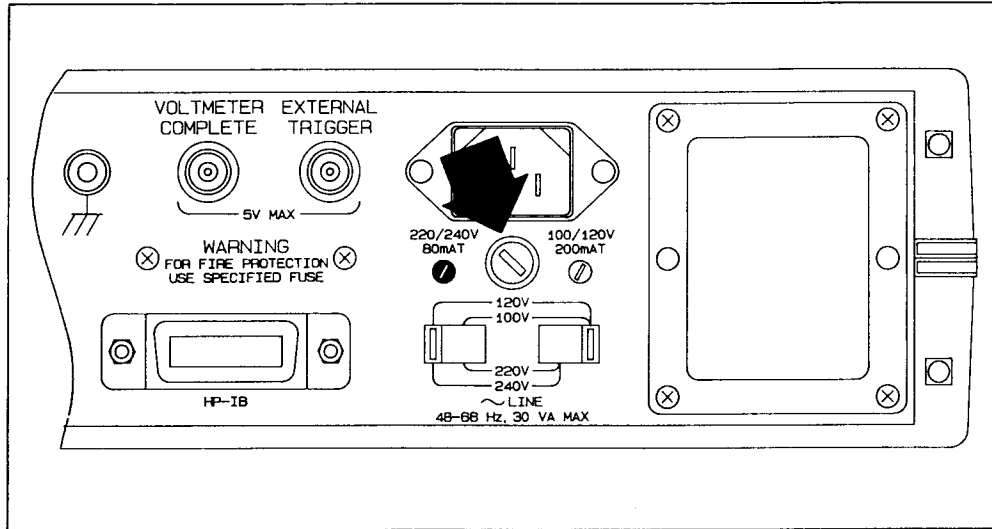


Figure 1-3 Line Power Fuse Holder

## Connecting the HP-IB Interface

Attach the HP-IB cable to the 24-pin HP-IB connector on the rear panel of the HP 3457. The connector is tapered to ensure proper orientation. Finger tighten the two screws on the cable connector. A typical interconnection of HP-IB compatible devices is shown in Figure 1-4.

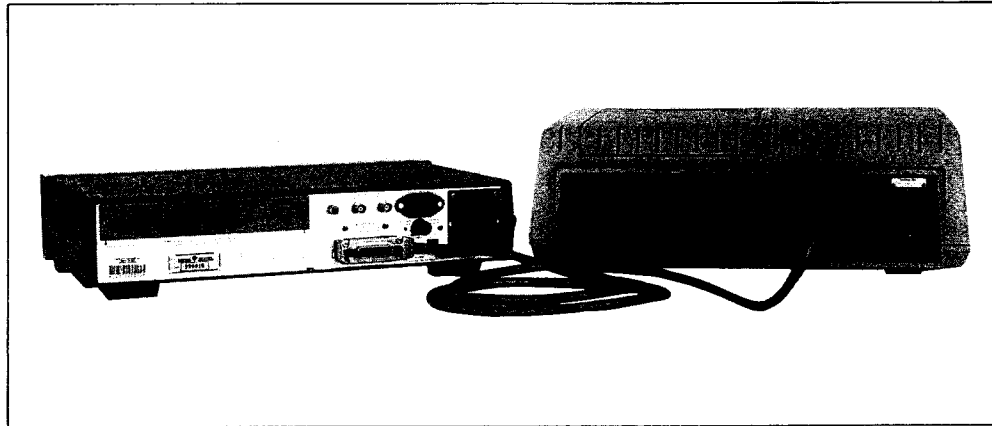


Figure 1-4. Typical HP-IB Interconnection

A total of 15 devices can be connected together on the same HP-IB interface bus. The cables have single male/female connectors on each end so that several cables can be stacked. This allows more than one cable to be attached to any one device. However, the maximum length of the HP-IB cables must not exceed 20 meters (65 feet) total, or 2 meters (6.5 feet) per device, whichever is less.

## Specifying the HP-IB Address

You can change the HP 3457's HP-IB address using the ADDRESS command. A procedure for changing the address can be found under "Changing the HP-IB Address," in Chapter 2. The HP 3457 leaves the factory with the address preset to decimal 22. The corresponding ASCII code is a listen address of 6 and a talk address of V. All of the HP-IB address codes are shown in Table 1-2.

Table 1-2. HP-IB Address Codes

Address Code	ASCII Code Character		Address Code	ASCII Code Character	
	Talk	Listen		Talk	Listen
0	@	SP	16	P	0
1	A	!	17	Q	1
2	B	"	18	R	2
3	C	#	19	S	3
4	D	\$	20	T	4
5	E	%	21	U	5
6	F	&	22	V	6
7	G	'	23	W	7
8	H	(	24	X	8
9	I	)	25	Y	9
10	J	*	26	Z	:
11	K	+	27	[	;
12	L	,	28	\	<
13	M	-	29	]	=
14	N	.	30	~	^
15	O	/	31	Talk Only Mode	

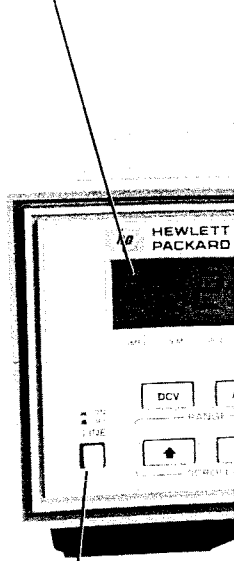
## Mounting the HP 3457

The HP 3457 comes equipped with four feet and two tilt stands in place; ready for use as a bench instrument. The front of the HP 3457 may be elevated by extending the tilt stands. The HP 3457 can also be mounted in a standard 19 inch rack with the optional rack mount kits (see Table 1-5).

## Operating the HP 3457

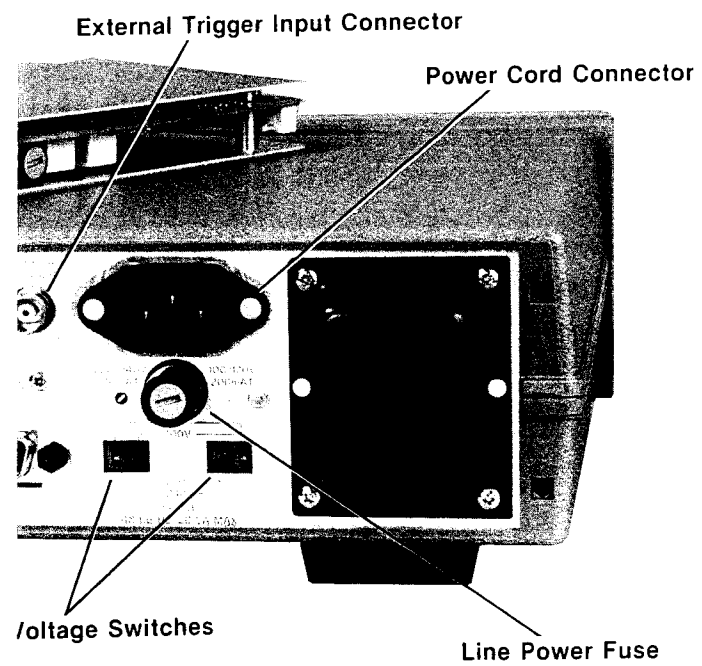
Now that you have installed your HP 3457, you can begin to learn about its operation. The following foldout has front and rear photographs of the HP 3457 showing the keyboard key groupings, rear panel connectors, and so on. You can use these photographs to familiarize yourself with the HP 3457. After that, you can use Chapter 2 to teach you the fundamentals of operating the HP 3457.

12 Character LCD Displa



Line Switch

it Connector



External Trigger Input Connector

Power Cord Connector

Voltage Switches

Line Power Fuse



# Maintenance

This section contains instructions for service trained personnel on how to replace the various fuses in the HP 3457. This section also describes how to obtain repair service.

## Replacing Fuses

The HP 3457 has a line power fuse, a front panel current fuse, and a rear panel current fuse. In addition, the HP 44491 Armature Relay Multiplexer Card contains two current fuses. Refer to chapter 5 for the location and replacement procedure for the HP 44491's current fuses.

### Line Power Fuse

The line power fuse holder is located on the right side of the HP 3457's rear panel. To replace the fuse, turn the HP 3457 off and remove its power cord. With a small flatblade screwdriver, push in on the fuse cap and rotate it counterclockwise. Remove the fuse cap and replace the fuse with the appropriate type. Re-install the fuse cap and apply power.

Replacement fuses and caps are available from Hewlett-Packard with the part numbers shown in Table 1-3.

**Table 1-3. Replacement Power Line Fuses and Caps**

Line Voltage	Power Line Fuse	Fuse Cap
100 or 120 VAC (Nominal)	200 mA, HP Part Number 2110-0235	Gray, HP Part Number 2110-0565
220 or 240 VAC (Nominal)	80 mA, HP Part Number 2110-0719	Black, HP Part Number 2110-0567

---

### CAUTION

*Make certain you install the correct fuse for your line voltage. If you install the wrong fuse, damage may occur to the HP 3457.*

---

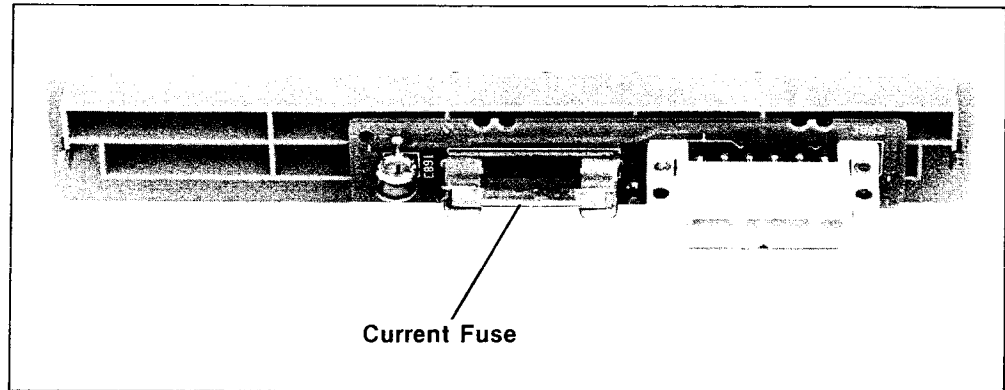
### Front Terminal Current Fuse

The front terminal current fuse is located next to the front panel amps (I) terminal and is marked *FUSE*. Before replacing the fuse, remove power and any external inputs from the HP 3457. With a small flatblade screwdriver, push in on the fuse cap and rotate it counterclockwise. Remove the fuse cap and fuse. Replace the fuse with a 1.5A 250V NTD fuse, HP part number 2110-0043.



### **Rear Terminal Current Fuse**

The rear terminal current fuse is located on the inside of the rear terminal assembly. Before replacing the fuse, remove power and any external inputs from the HP 3457. To replace the fuse, remove the rear terminal assembly (a removal procedure is located in “Installing a Plug-In Card” in Chapter 5). Figure 1-5 shows the location of the rear terminal current fuse. Replace this fuse with a 1.5A 250V NTD fuse, HP part number 2110-0043.



**Figure 1-5. Rear Terminal Current Fuse**

### **How to Obtain Repair Service**

You may have your HP 3457 repaired at an HP service center whether it is under warranty or not. There is a charge for repairs after the warranty period. Contact your local Sales and Service Office for shipping instructions prior to returning the instrument. A list of Sales and Service Offices is located in the back of this manual.

### **Serial Number**

Hewlett-Packard instruments are identified by a two-part, ten-digit serial number of the form *0000A00000*. The first four digits are the same for all identical products. They change only when a change is made to the product. The letter indicates the country of origin. An A indicates the product was made in the United States of America. The last five digits are unique to each instrument.

The serial number for your HP 3457 is located on the lower left corner of the rear panel. Keep a separate record of this serial number. If your HP 3457 becomes lost or stolen the complete serial number is often necessary for tracing and recovery as well as for insurance claims.



## General Shipping Instructions

If you need to ship your HP 3457, remove any plug-in card from the HP 3457's rear slot. Use clean handling and anti-static techniques when removing and packaging a plug-in card. **PUT THE PLUG-IN CARD IN AN ANTI-STATIC BAG.** Be certain that the HP 3457 and the plug-in card are in protective packages (use the original shipping containers and cushioning materials) to prevent transit damage. Such damage is not covered by warranty.

Attach a tag to the shipment identifying the owner and indicating the service or repair needed. Include the model number and serial number of the HP 3457 and/or optional plug-in cards. We suggest that you insure the shipment.

## Abbreviated Specifications

Table 1-4 is an abbreviated listing of the HP 3457's specifications. Specifications are the performance standards or limits against which the HP 3457 is tested. Refer to the HP 3457 Service Manual for a complete listing of the HP 3457's specifications. Specifications for the optional plug-in cards are in Chapter 5.

**Table 1-4. HP 3457 Specifications**

### Maximum Input Current

1.5 amps from 250 volt source. Current inputs are fuse protected.

### Maximum Input Voltage:

HI to LO INPUT terminals: +/- 450 V peak  
HI or LO terminal to earth ground +/- 450 V peak  
HI or LO  $\Omega$  SENSE to LO INPUT +/-350 V peak  
Front terminals to rear terminals +/- 450 V peak

### DC Voltage

Accuracy (90 day, Tcal  $\pm$  5°C)

Range	Maximum Reading	Best 6½ Digit Accuracy (1) $\pm$ (% Rdg + Cnts)	
		% of Reading	Count Error
30 mV	30.30000 mV	0.0040	365
300 mV	303.0000 mV	0.0025	39
3.0 V	3.030000 V	0.0017	6
30.0 V	30.30000 V	0.0035	19
300.0 V	303.0000 V	0.0050	6

**Table 1-4. HP 3457 Specifications (cont'd)**

**DC Current**

Accuracy (90 day, Tcal ± 5°C)

Range	Maximum Reading	Best 6½ Digit Accuracy (1) ± (% Rdg + Cnts)	
		% of Reading	Count Error
300 µA	303.0000 µA	0.02	104
3 mA	3.030000 mA	0.02	104
30 mA	30.300000 mA	0.02	104
300 mA	303.0000 mA	0.07	204
3 A	1.000000 A	0.07	604

**2 and 4-wire ohms**

Accuracy (2) (90 day, Tcal ± 5°C)

Range	Maximum Reading	Best 6½ Digit Accuracy (1) ±(% Rdg + Cnts)		
		% of Reading	Count Error	Current Output
30 Ohm	30.30000 Ohm	0.0065	20315	1 mA
300 Ohm	303.0000 Ohm	0.0045	2034	1 mA
3 kOhm	3.030000 kOhm	0.0035	206	1 mA
30 kOhm	30.30000 kOhm	0.0035	26	100 µA
300 kOhm	303.0000 kOhm	0.0040	9	10 µA
3 MOhm	3.030000 MOhm	0.0055	12	1 µA
30 MOhm	30.30000 MOhm	0.0250	80	100 nA
(3)300 MOhm	303.0000 MOhm	1.60	1000	100 nA
(3)3.0 GOhm	3.030000 GOhm	16.0	1000	100 nA

1. After 1 hr. warm-up, integration time 100 PLC. Tcal is the temperature of the calibration environment between 18 and 28°C.
2. For 2-wire ohms, add 200 mOhms to count error specifications.
3. For 2-wire ohms only, accuracy is specified following autocal (ACAL), under stable conditions (± 1°C.)

**Common Mode Rejection (dB)**

(1 kOhm unbalance in low lead) DC ECMR 140 dB; AC NMR:<1 PLC, 76 dB; AC ECMR > 1 PLC 156 dB, for 50, 60 Hz ±.08%.

**Reading Rates (DCV, DCI, and Resistance up to 30 kOhm) <sup>(1)</sup>**

Power Line Cycles (2)	Maximum # of Digits	Readings Per Second;60Hz (50Hz)		
		Auto Zero On	Auto Zero Off	NMR
0.0005	3½	300	1350	0
0.005	4½	280	1250	0
0.1	5½	140 (128)	360 (312)	0
1.0	6½	26 (22)	53 (45)	60dB
10	* 7½	2.5 (2.0)	4.8 (4.0)	80dB
100	* 7½	.25 (0.2)	48 (0.4)	90dB

\* Using Math HIRES mode.

1. Reading rates are specified with zero delay, fixed range, display off, and front panel off. The output is to internal reading memory using single integer (SINT) format and internal timer.
2. Integration time in power line cycles (PLCS).

**Table 1-4. HP 3457 Specifications (cont'd)**

**AC Voltage**

90 Day: Tcal  $\pm$  5°C  
30 mV to 30 V ranges

Frequency	*Percent of Reading	Number of Counts			
		$\geq 1$ PLC 6½ Digits	0.1 PLC 5½ Digits	.005 PLC 4½ Digits	.0005 PLC 3½ Digits
20 Hz - 45 Hz	0.75	2800	290	32	7
46 Hz - 100 Hz	0.20	2800	290	32	7
101 Hz - 20 kHz	0.13	2800	290	32	7
**400 Hz - 20 kHz	0.13	2800	750	80	12
21 kHz - 100 kHz	0.65	4000	400	42	8
101 kHz - 300 kHz	3.15	13000	1300	135	17
301 kHz - 1 MHz	9.55	67000	6700	675	70

90 Day: Tcal  $\pm$  5°C  
300 V range

Frequency	*Percent of Reading	Number of Counts			
		$\geq 1$ PLC 6½ Digits	0.1 PLC 5½ Digits	.005 PLC 4½ Digits	.0005 PLC 3½ Digits
20 Hz - 45 Hz	0.8	2800	290	32	7
46 Hz - 100 Hz	0.28	2800	290	32	7
101 Hz - 20 kHz	0.2	2800	290	32	7
**400 Hz - 20 kHz	0.2	2800	750	80	12
21 kHz - 100 kHz	1.15	5500	550	60	9

\* Specifications apply within one week of AC auto-cal (ACAL 2) for stable temperature conditions (Tcal  $\pm$  5°C). If AC auto-cal is not used, add 0.7 to the percent of reading figures. For 1 year specifications, add .08% to 90 day percent of reading figures.

\*\* Using AC fast filter (ACBAND 400) for frequencies above 400 Hz.

**Table 1-4. HP 3457 Specifications (cont'd)**

**AC + DC Voltage**

90 Day: Tcal  $\pm$  5°C

30 mV to 300 V ranges (300 V range is not specified above 100 kHz)

Frequency	*Percent of Reading	Number of Counts			
		$\geq 1$ PLC 6½ Digits	0.1 PLC 5½ Digits	.005 PLC 4½ Digits	.0005 PLC 3½ Digits
20 Hz - 45 Hz	1.5	40000	4000	410	44
46 Hz - 100 Hz	0.4	40000	4000	410	44
101 Hz - 20 kHz	0.3	40000	4000	410	44
**400 Hz - 20 kHz	0.65	40000	6500	650	65
21 kHz - 100 kHz	1.2	43000	4300	440	47
101 kHz - 300 kHz	3.3	50000	7500	750	75
301 kHz - 1 MHz	9.7	110000	13500	1350	135

\* Specifications apply within one week of AC auto-cal (ACAL 2) for stable temperature conditions. If AC auto-cal is not used, add 0.6 to the percent of reading figures, add 39000 to the 6½ digit counts, add 3900 to the 5½ digit counts, add 390 to the 4½ digit counts and 39 to the 3½ digit counts. For 1 year specifications, add .08% to 90 day percent of reading figures.

\*\* Using AC fast filter (ACBAND 400) for frequencies above 400 Hz.

**Table 1-4. HP 3457 Specifications (cont'd)**

**AC Current**

90 Day: Tcal ± 5°C  
30 mA to 300 mA ranges

Frequency	*Percent of Reading	Number of Counts			
		≥ 1 PLC 6½ Digits	0.1 PLC 5½ Digits	.005 PLC 4½ Digits	.0005 PLC 3½ Digits
20 Hz - 45 Hz	0.85	2800	290	32	7
46 Hz - 100 Hz	0.3	2800	290	32	7
101 Hz - 20 kHz	0.25	2800	290	32	7
**400 Hz - 20 kHz	0.25	2800	750	80	12
21 kHz - 100 kHz	1.0	4000	400	42	8

90 Day: Tcal ± 5°C  
3 A range (1 amp maximum input)

Frequency	*Percent of Reading	Number of Counts			
		≥ 1 PLC 6½ Digits	0.1 PLC 5½ Digits	.005 PLC 4½ Digits	.0005 PLC 3½ Digits
20 Hz - 45 Hz	.95	2800	290	32	7
46 Hz - 100 Hz	0.4	2800	290	32	7
101 Hz - 20 kHz	0.35	2800	290	32	7
**400 Hz - 20 kHz	0.35	2800	750	80	12

\* Specifications apply within one week of AC auto-cal (ACAL 2) for stable temperature conditions. If AC auto-cal is not used, add 0.6 to the percent of reading figures. For 1 year specifications, add .08% to 90 day percent of reading figures.

\*\* Using AC fast filter (ACBAND 400) for frequencies above 400 Hz.

**AC + DC Current**

90 Day: Tcal ± 5°C  
30 mV to 300 mA ranges

Frequency	*Percent of Reading	Number of Counts			
		≥ 1 PLC 6½ Digits	0.1 PLC 5½ Digits	.005 PLC 4½ Digits	.0005 PLC 3½ Digits
20 Hz - 45 Hz	1.55	16000	1600	165	20
46 Hz - 100 Hz	0.4	16000	1600	165	20
101 Hz - 20 kHz	0.3	16000	1600	165	20
**400 Hz - 20 kHz	0.65	16000	3750	375	42
21 kHz - 100 kHz	0.95	17500	1750	180	22

90 Day: Tcal ± 1°C  
3 A range (1 amp maximum input)

Frequency	*Percent of Reading	Number of Counts			
		≥ 1 PLC 6½ Digits	0.1 PLC 5½ Digits	.005 PLC 4½ Digits	.0005 PLC 3½ Digits
20 Hz - 45 Hz	1.65	16000	1600	165	20
46 Hz - 100 Hz	0.5	16000	1600	165	20
101 Hz - 20 kHz	0.4	16000	1600	165	20
**400 Hz - 20 kHz	0.75	16000	3750	375	42

\* Specifications apply within one week of AC auto-cal (ACAL 2) for stable temperature conditions. If AC auto-cal is not used, add 0.6 to the percent of reading figures, add 6000 to the 6½ digit counts, add 600 to the 5½ digit counts, add 60 to the 4½ digit counts and 6 to the 3½ digit counts. For 1 year specifications, add .08% to 90 day percent of reading figures.

\*\* Using AC fast filter (ACBAND 400) for frequencies above 400 Hz.

**Table 1-4. HP 3457 Specifications (cont'd)**

**Reading Rates** (ACV and ACI) <sup>(1)</sup>

Power Line Cycles	Maximum # of Digits	Readings per Second; 60 Hz(50 Hz)	
		Input < 400 Hz (Slow Response)	Input > 400 Hz (Fast Response)
0.0005	3½	1	9.5
0.005	4½	1	9.5
0.1	5½	1	9.25 (9.2)
1	6½	1	7.25 (6.9)
10	6½	0.7 (0.65)	2.0 (1.7)
100	6½	0.2 (0.17)	0.25 (0.2)

1. Reading rates are specified with preprogrammed delays, fixed range, and autozero on.

**Frequency and Period**

Measures the frequency or period of the AC component of the AC or DC coupled voltage or current input. The counter uses a reciprocal counting technique to give constant resolution independent of input frequency.

Maximum Inputs: 1 MOhm shunted by < 90 picofarads.

Frequency Range: 10 Hz to 1.5 MHz (voltage input)  
10 Hz to 100 KHz (current input)

Period Range: 100 ms to 667 ns (voltage input)  
100 ms to 3.33 us (current input)

Sensitivity: 10 mV RMS or 100 uA RMS (sinewave)

Triggering: Triggers and counts on zero crossings.

Accuracy: (1 year, Tcal ± 5°C)

Frequency	Period	± % of Reading
10 Hz to 400 Hz	.1 s to .025 s	0.05
400 Hz to 1.5 MHz	.025 s to 667 ns	0.01

Maximum Reading Rate: 2.0 rdgs/s for integration time of 1 PLC, fast settling time, delay zero, math off, and fixed range.

**Memory**

2208 available bytes that can be partitioned into 3 segments; reading memory, subprogram memory, and state memory.

**Table 1-4. HP 3457 Specifications (cont'd)**

**Operating Characteristics**

Operating Temperature: 0 to 55°C.

Warmup Time: one hour for all specifications except where noted

Humidity Range: 95% R.H., 0 to 40°C.

Storage Temperature: -40 to +75°C.

Power: 100/120/220/240 V  $\pm 10\%$ , 48 Hz - 66 Hz. Fused at .2A (100/120V) or 0.08 A (220/240V). < 30 VA

Size: 89 mm H (without removable feet) x 425 mm W x 292 mm D (3.5" x 16.75" x 11.5"). Height (with removable feet): 100 mm (4"). Allow 76 mm (3") additional depth for wiring.

Net Weight: 5.05 kgm (11.1 lbs)

Shipping Weight: 9.3 kgm (20.5 lbs)

**Herstellerbescheinigung**

Hiermit wird bescheinigt, daß das Gerät/System HP 3457A in Übereinstimmung mit den Bestimmungen von Postverfügung 1046/84 funkentstört ist.

Der Deutschen Bundespost wurde das Inverkehrbringen dieses Gerätes/Systems angezeigt und die Berechtigung zur Überprüfung der Serie auf Einhaltung der Bestimmungen eingeräumt.

**Zusatzinformation für Meß- und Testgeräte**

Werden Meß- und Testgeräte mit ungeschirmten Kabeln und/oder in offenen Meßaufbauten verwendet, so ist vom Betreiber sicherzustellen, daß die Funk-Entstörbestimmungen unter Betriebsbedingungen an seiner Grundstücksgrenze eingehalten werden.

**Manufacturer's declaration**

This is to certify that the equipment HP 3457A is in accordance with the Radio Interference Requirements of Directive FTZ 1046/84. The German Bundespost was notified that this equipment was put into circulation, the right to check the series for compliance with the requirements was granted.

**Additional Information for Test- and Measurement Equipment**

If Test- and Measurement Equipment is operated with unshielded cables and/or used for measurements on open set-ups, the user has to assure that under operating conditions the Radio Interference Limits are still met at the border of his premises.

# Options and Accessories

Table 1-5 lists the available options, and Table 1-6 lists the accessories for your HP 3457.

**Table 1-5. Options**

Description	Option Number	HP Part Number
Side Handle Kit	401	5061-1171
Front Handle Kit	907	5061-1170
Rack Flange Kit	908	5061-1168
Rack Flange & Front Handle Kit	909	5061-1169
Extra Operating and Service Manual (includes Quick Ref. Guide)	910	
2 Additional Years of Return to HP Hardware Support	W30	

**Table 1-6. Accessories**

Description	HP Model or Part Number
Extra Quick Reference Guide	03457-90004
Rack Mount Slide Kit	HP 44490A
Armature Relay Multiplexer Card	HP 44491A
Reed Relay Multiplexer Card	HP 44492A
Extra Wiring Block/Strain Relief Housing for 44491A	HP 44493A
Extra Wiring Block/Strain Relief Housing for 44492A	HP 44494A
High Voltage Attenuator Card	HP 44497A
1 Meter HP-IB Cable	HP 10833A
2 Meter HP-IB Cable	HP 10833B
4 Meter HP-IB Cable	HP 10833C
0.5 Meter HP-IB Cable	HP 10833D
Test Lead Kit	HP 34118A
RF Probe (detects AC voltage up to 700 MHz)	HP 11096B
High Voltage DC Probe	HP 34111A
High Voltage AC/DC Probe	HP 34119A
Thermistor Pack (Qty. 4)	HP 44414A
Test/Calibration Software:	
For use on the HP 85B Computer	03457-10085
For use on the HP Series 200 Computer	03457-10200





# CONTENTS

	Page		Page
Introduction.....	2-1	NULL.....	2-25
Before Applying Power.....	2-1	MATH OFF.....	2-25
Applying Power.....	2-1	MATH CONT.....	2-25
The Power-On Sequence.....	2-2	Presetting Registers.....	2-26
Power-On Self-Test.....	2-2	Statistics.....	2-26
Address Display.....	2-2	Display Control.....	2-27
Power-On State.....	2-2	Correcting Mistakes.....	2-29
Operating From the Front Panel.....	2-3	Viewing Long Displays.....	2-30
The Complete Self-Test.....	2-3	Last Entry.....	2-30
Reading the Error Register.....	2-4	Clearing the Display.....	2-31
Clearing the Display.....	2-5	Viewing Extra Information.....	2-31
Resetting the HP 3457.....	2-5	Display Test.....	2-31
Making Standard 2-Wire Measurements.....	2-6	Operating from Remote.....	2-32
DC Voltage.....	2-6	Enter/Output Statements.....	2-32
AC Voltage.....	2-6	Reading the HP-IB Address.....	2-32
2-Wire Ohms.....	2-7	Changing the HP-IB Address.....	2-33
AC+DC Voltage.....	2-7	Sending a Remote Command.....	2-33
Frequency.....	2-7	Getting Data from the HP 3457.....	2-34
Period.....	2-8	The LOCAL key.....	2-35
Making Current Measurements.....	2-8	Often-Used Commands.....	2-36
DC Current.....	2-9	Self-Test.....	2-36
AC Current.....	2-9	Reading the Error Register(s).....	2-36
AC+DC Current.....	2-9	RESET.....	2-37
Making 4-Wire Ohms Measurements.....	2-10	Measurement Functions.....	2-37
Autoranging & Manual Ranging.....	2-10	Range Parameter.....	2-38
HOLD.....	2-11	Resolution Parameter.....	2-39
Manual Ranging.....	2-11	Defaulting Parameters.....	2-40
Autoranging.....	2-11	Setting the Number of Power Line Cycles.....	2-40
Using the Configuration Keys.....	2-12	Triggering Measurements.....	2-41
Selecting a Parameter.....	2-13	Single Trigger.....	2-41
Numeric Equivalents.....	2-15	Synchronous Trigger.....	2-41
Default Values.....	2-15	PRESET.....	2-42
Numeric Parameters.....	2-16	Reading the Status Register.....	2-42
Exponential Parameters.....	2-17	Additional Functions.....	2-43
Multiple Parameters.....	2-18	Using the Rear Terminals.....	2-43
Using the Alphabetic Command Directory.....	2-19	Digits Displayed.....	2-44
Selecting a command.....	2-21	Range Commands.....	2-44
Parameters.....	2-21	Delay.....	2-45
Executing a Command.....	2-21	Number of Readings.....	2-46
Query Commands.....	2-22	Reading Memory.....	2-46
Standard Queries.....	2-22	Recalling Readings.....	2-47
Additional Queries.....	2-23	RMEM Command.....	2-47
Using the Math Functions.....	2-24	State Memory.....	2-49
		Temperature Measurements.....	2-49

# How to Operate Your HP 3457

---

## Introduction

This chapter contains step-by-step procedures that teach you the fundamentals of operating your HP 3457 and how to make measurements. It is divided into four major sections. The first section shows you how to operate your HP 3457 locally from the front panel. The second section shows you the fundamentals of remote HP-IB\* operation. The third section shows you some of the most often-used functions. Finally, the fourth section shows you some additional functions that will help you to get the most out of your HP 3457. Since local operation occurs first, it covers important topics such as the various ways to enter parameters and how to make measurements. We recommend that you perform the procedures in all four sections before attempting to operate the HP 3457.

## Before Applying Power...

- Make sure the line voltage selection switches are set to match your local line voltage.
- Make sure the proper fuse is installed.

If you have any questions concerning installation or power requirements, read Chapter 1.

## Applying Power

To turn on the HP 3457, depress the front panel LINE switch. After you depress the switch, the HP 3457 begins its power-on sequence.

If your HP 3457 does not appear to turn-on, verify that the HP 3457 is connected to line power. If line power is not the problem, remove the power cord and check the line power fuse and the line voltage selection switch settings. If you cannot locate the problem, refer to the HP 3457 Service Manual.

\*HP-IB (Hewlett-Packard Interface Bus) is Hewlett-Packard's implementation of IEEE Standard 488-1978 and ANSI MC1.1.

## The Power-On Sequence

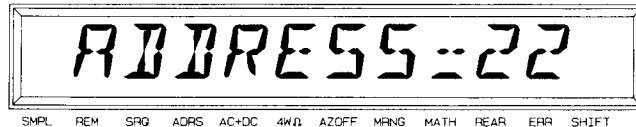
The power-on sequence takes about 3 seconds. It consists of a power-on self-test and a display of the present address.

### Power-On Self-Test

The power-on self-test verifies that the HP 3457 is operating but does not necessarily verify that measurements will be accurate.

### Address Display

Following the power-on self-test, the display temporarily shows the present HP-IB address. A typical address display is:



### Power-On State

When the power-on sequence is finished, the HP 3457 beeps once, automatically triggers, automatically selects the range, and performs DC voltage measurements. Also, the HP 3457 has set many of its commands to predefined power-on values. This is called the power-on state.

In the power-on state, the display shows DC voltage measurements. Along the bottom of the display are a series of triangular shaped annunciators. These annunciators alert you to a variety of conditions. For example, the SMPL annunciator, as shown in Figure 2-1, flashes to indicate the HP 3457 is sampling (making measurements).

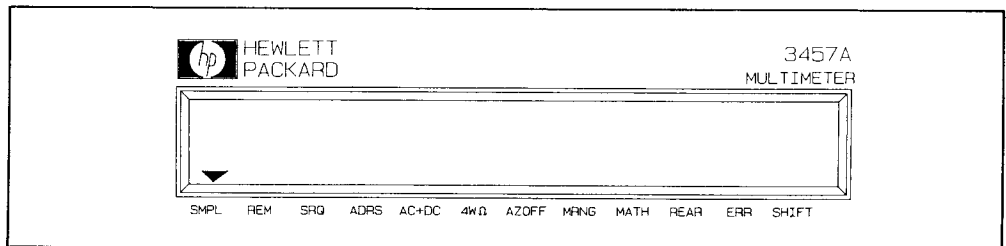


Figure 2-1. SMPL Annunciator

If you want to know more about the HP 3457's display or the annunciators, refer to "The LCD Display" in Chapter 3, Functions and Features.

---

#### NOTE

*If your ERR annunciator is flashing, an error was detected during or after the power-on self-test. You will learn how to find out about the error later in this chapter in "Reading the Error Register."*

---

# Operating from the Front Panel

This section describes how to make measurements and control the HP 3457 from its front panel keyboard.

## The Complete Self-Test

When you applied power to the HP 3457, it automatically did a limited self-test. Before you start making measurements, however, you may want to have more confidence that your HP 3457 is fully operational. This is the job of the complete self-test. The complete self-test performs an extensive series of tests that check the HP 3457's operability and accuracy.

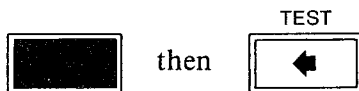
---

### NOTE

*Always disconnect any input signals before you run self-test. If you leave an input signal connected to the HP 3457, it may cause a self-test failure.*

---

To run the complete self-test press these two keys in the sequence shown:



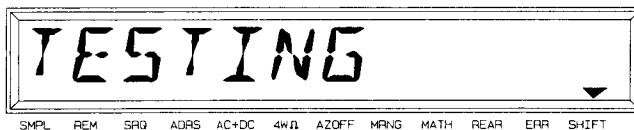
---

### NOTE

*When you press the blue shift key, the display's SHIFT annunciator turns on. The shifted functions are printed in blue above the keys.*

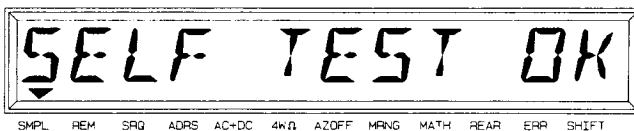
---

The HP 3457 begins the complete self-test and the display shows:



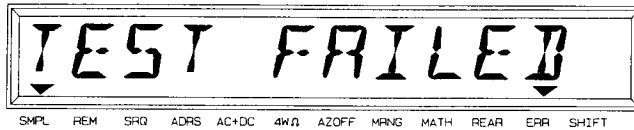
The complete self-test takes about 7 seconds.

If the self-test passed, the display shows:



- If the complete self-test passed and the ERR annunciator *is not* flashing, you have a very high confidence that the HP 3457 is totally operational and that measurements will be accurate.
- If the complete self-test passed and the ERR annunciator *is* flashing, an error was detected after the self-test. Refer to the following section “Reading the Error Register.”

If any of the tests failed, the error annunciator flashes and the display shows:

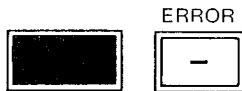


- If the complete self-test failed, one or more error conditions have been detected. Refer to the following section “Reading the Error Register”.

If you want to know more about the tests performed during self-test, refer to “Self-Tests and Calibration” in Chapter 3.

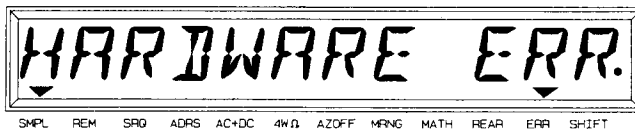
## Reading the Error Register

Whenever the display’s ERR annunciator is flashing, one or more errors have been detected. An error record is stored in the HP 3457’s error register. To read the error register press:



The display shows the description of the error. If the ERR annunciator is still flashing, there are more errors in the error register.

Example Error Display:



You read the next error just as you read the first. When you have read all the errors, the ERR annunciator goes off. If you try to read another error, the display returns to displaying measurements.

---

**NOTE**

*If you get **HARDWARE ERR**, run the self-test again. If you repeatedly get this error, your HP 3457 may need repair. The HP 3457 stores a record of hardware-related error(s) in the auxiliary error register. You will learn how read that register later in this chapter.*

---

You do not have to run self-test to get an error. The HP 3457 detects errors that occur while entering data, when changing functions or ranges, and so on. The HP 3457 beeps whenever it detects an error. If you want to know more about errors, refer to “The Error Register” and “The Auxiliary Error Register” in Chapter 3.

## Clearing the Display

Whenever you want to clear information (such as an error description) from the display and return it to displaying measurements, press:



## Resetting the HP 3457

Many times during operation, you may wish to return to the power-on state. The reason may be an error in entering commands, you lost track of what you were doing, or you are experimenting with a command and want to be in a known starting state. The reset function returns you to the power-on state without cycling the HP 3457's power. To reset the HP 3457, press:



Reset takes about 2 seconds.

---

**NOTE**

*You should perform the procedures in this section in the order that they appear. If you perform them out of order or alter them in some way, you may get different results from those described. If this happens, reset the HP 3457 and start over.*

---

If you want to know more about the HP 3457's reset state, refer to “Predefined States” in Chapter 3.

# Making Standard 2-Wire Measurements

The HP 3457 performs six standard 2-wire measurements. These are DC voltage, AC voltage, 2-wire ohms, AC + DC voltage, frequency, and period. For standard 2-wire measurements, connect the signal or resistance you are measuring to the HI and LO INPUT terminals as shown in Figure 2-2.

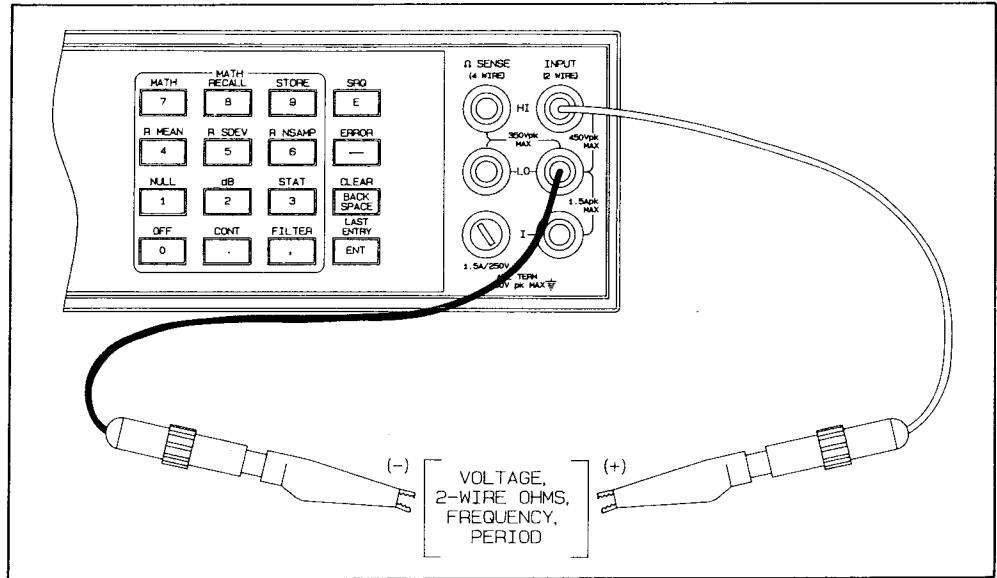
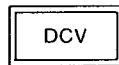
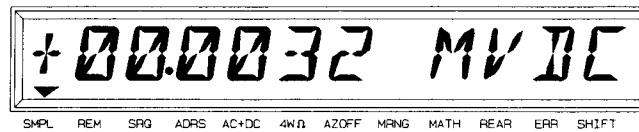


Figure 2-2. Standard 2-Wire Measurements

**DC Voltage** To select DC voltage measurements press:

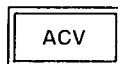


With the front panel input terminals connected together (shorted) a typical display is:



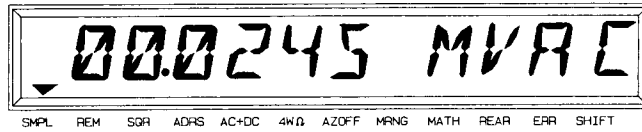
The “MVDC” indicates you are measuring millivolts DC.

**AC Voltage** To select AC voltage measurements press:



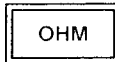


With the front panel input terminals connected together (shorted) a typical display is\*:

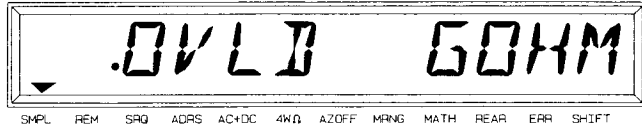


The “MVAC” indicates you are measuring millivolts AC.

**2-Wire Ohms** To select 2-wire ohms measurements press:



If you have nothing connected to the front input terminals, the display shows:

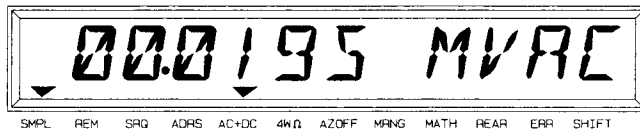


This display indicates an overload condition (OVLD) and that the HP 3457 has selected the 3 gigohm (GOHM) range.

**AC + DC Voltage** To select AC + DC voltage measurements press:



With the front panel input terminals connected together (shorted), a typical display is\*:



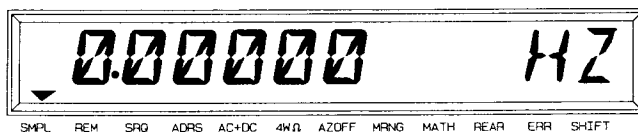
Notice that the display is showing AC voltage and the display’s AC + DC annunciator is on.

**Frequency** To select frequency measurements press:



\* For AC or AC + DC measurements, the noise displayed when the input terminals are shorted becomes swamped-out (overridden) when an input signal is applied. This effectively negates the noise; do not subtract the noise reading from future measurements.

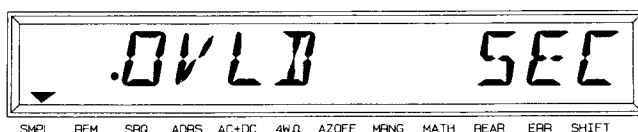
With the front panel input terminals connected together (shorted), the display shows:



**Period** To select period measurements press:



With the front panel input terminals connected together (shorted), the display shows:



If you want to know more about one of the above measurements, look under the type of measurement (AC voltage, 2-wire ohms, and so on) in Chapter 3.

## Making Current Measurements

The HP 3457 performs three types of current measurements. These are DC current, AC current, and AC + DC current. For current measurements, connect a current source to the input terminals as shown in Figure 2-3.

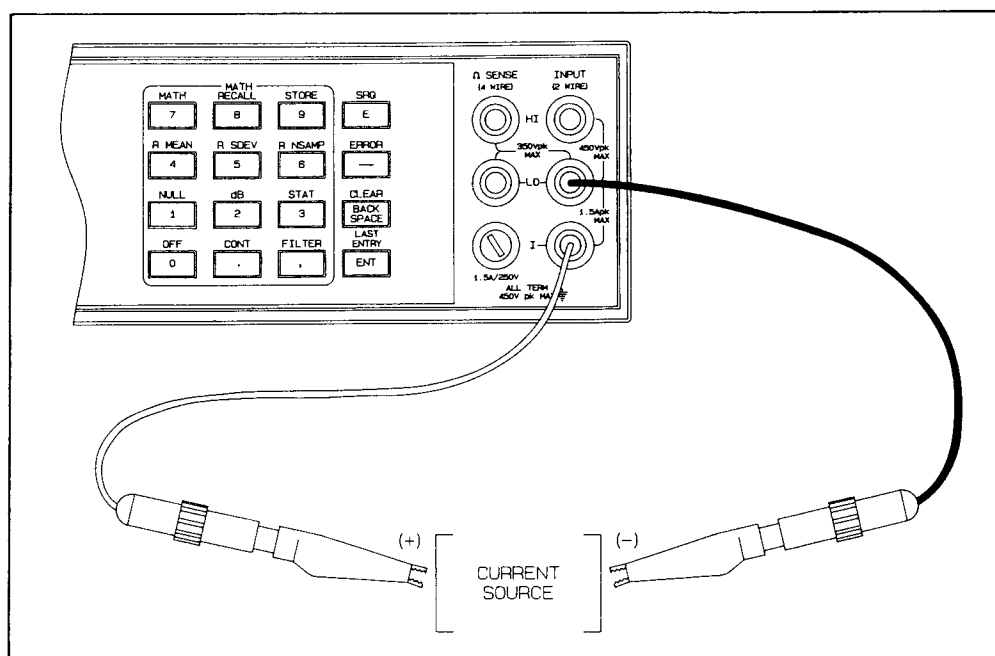
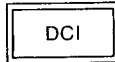
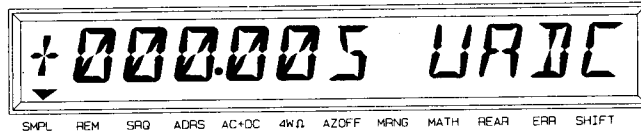


Figure 2-3. Current Measurements

**DC Current** To select DC current measurements press:

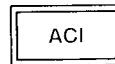


With the front panel input terminals connected together (shorted), a typical display is:

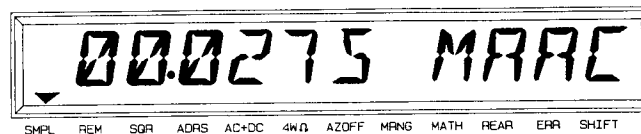


The "UADC" indicates you are measuring microamps DC.

**AC Current** To select AC current measurements press:



With the front panel input terminals connected together (shorted), a typical display is\*:

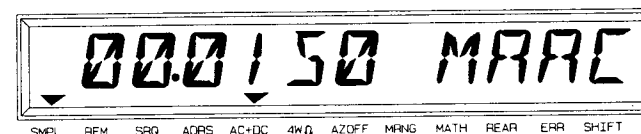


The "MAAC" indicates you are measuring milliamps AC.

**AC + DC Current** To select AC + DC current measurements press:



With the front panel input terminals connected together (shorted), a typical display is\*:



The "MAAC" indicates you are measuring milliamps AC. Notice the display's AC + DC annunciator is on.

If you want to know more about current measurements, refer to "Current Measurements" in Chapter 3.

\* For AC or AC + DC measurements, the noise displayed when the input terminals are shorted becomes swamped-out (overridden) when an input signal is applied. This effectively negates the noise; do not subtract the noise reading from future measurements.

## Making 4-Wire Ohms Measurements

To make 4-wire ohms measurements, connect a resistance to the input terminals as shown in Figure 2-4.

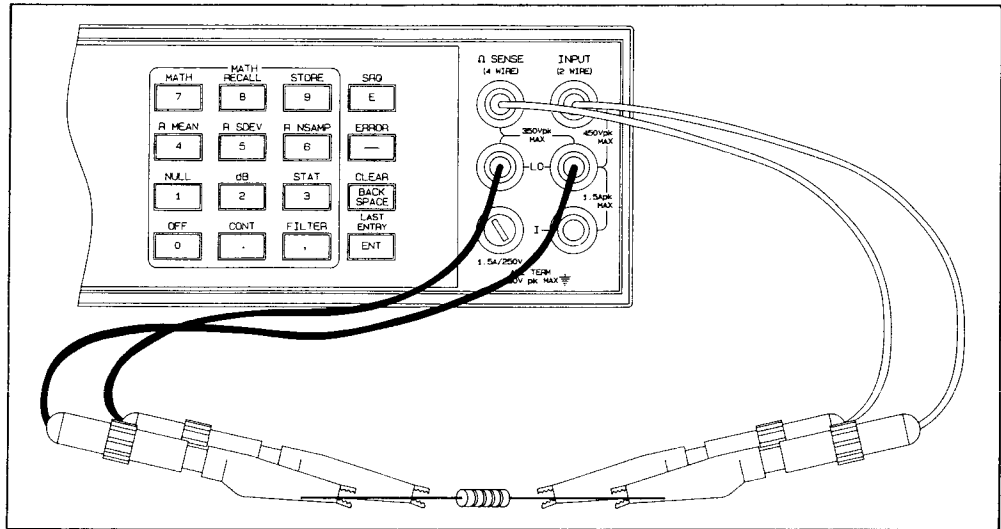
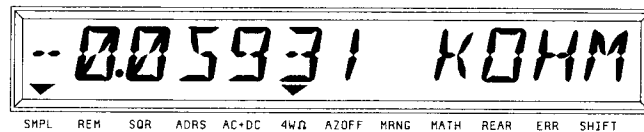


Figure 2-4. 4-Wire Ohms Measurements

To select 4-wire ohms measurements press:



If nothing is connected to the front terminals, a typical display is:



On the higher 4-wire ohms ranges, the HP 3457 does not display OVL D when nothing is connected to the input terminals. Notice the display's 4WΩ annunciator is on.

Reset the HP 3457 to return it to the power-on state.

If you want to know more about 4-wire ohms measurements, refer to "4-Wire Ohms" in Chapter 3, Functions and Features.

## Autorangeing and Manual Ranging

You may have noticed that, in the power-on state, the HP 3457 automatically selects the appropriate measurement range. This is called the autorange feature. In most cases, you will probably want to continue using autorange. However, you have two other ranging choices; hold and manual ranging.

**Hold** This choice lets autorange choose a range and then shuts off autoranging. The HP 3457 then holds the present range. To do this, let autorange choose a range then press:



Notice the display's MRNG (manual range) annunciator is on. This annunciator is on whenever you are not using autorange.

**Manual Ranging** The second choice lets you manually select the range. When the HP 3457 is in the measurement mode (that is, the HP 3457 is making and displaying measurements or the display is showing OVL D) you can change the range by pressing the up or down arrow keys. To go to a higher range, press:



By successively pressing the up arrow key, you can increment up to the highest range. When you reach the highest range, pressing the up arrow key no longer changes the range.

To go to a lower range press:



By successively pressing the down arrow key, you can decrement down to the lowest range. When you reach the lowest range, pressing the down arrow key no longer changes the range.

**Autoranging** If you want to return to autoranging, press:



## Using the Configuration Keys

The configuration keys (Figure 2-5) let you rapidly access the most-used features. These features include measurement setup, triggering, front or rear terminals, memory, and state storage.

---

### NOTE

*Most of the configuration keys allow you to select additional parameters. The AUTO and SINGLE trigger keys, however, do not have parameters. The HP 3457 executes either of these keys immediately when pressed. You will learn about the auto and single trigger modes later in this chapter under “Triggering Measurements.”*

---

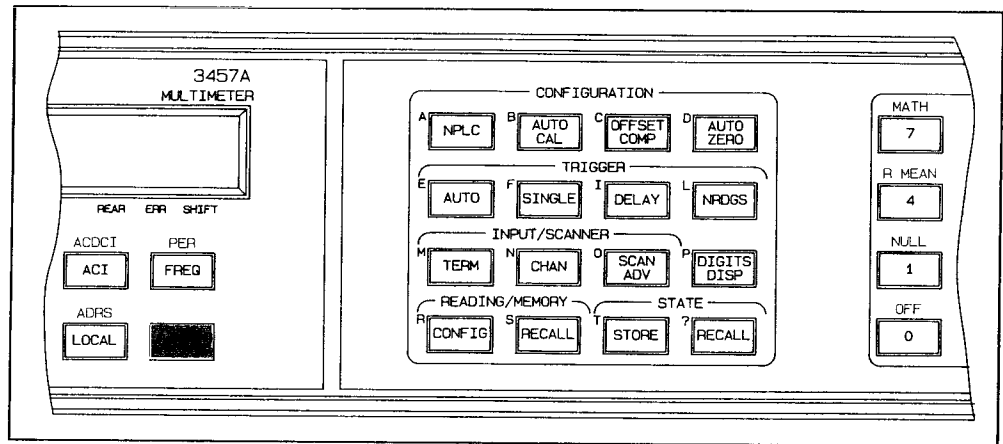


Figure 2-5. Configuration Keys

We will use the AUTO CAL key to demonstrate how to use the configuration keys.

---

### NOTE

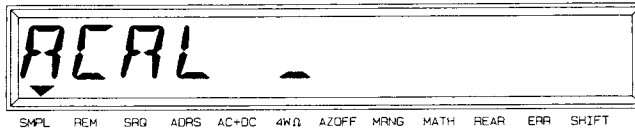
*Always disconnect any input signals before you run autocal. If you leave an input signal connected to the HP 3457, it may adversely affect autocal.*

---

Press:



The display shows:



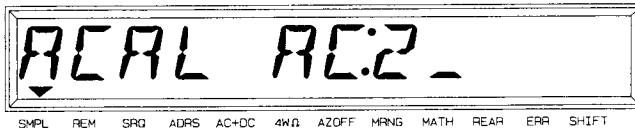
This is the command header for the autocal command. Notice the HP 3457 automatically placed a space *delimiter* behind the command header. A delimiter is defined as any punctuation that serves to separate elements of a command string or to end the string.

### Selecting a Parameter

For parameters that have a list of choices, you can use the up and down arrow keys to review the choices. We will refer to any list of parameter choices as a *menu*. Press:



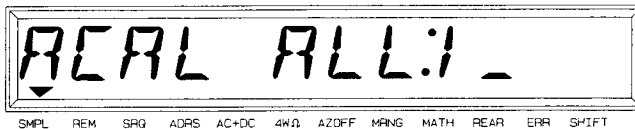
The display shows:



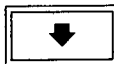
Press:



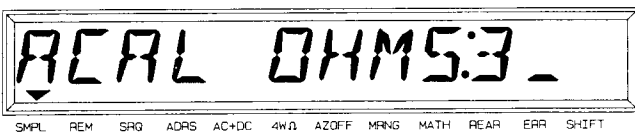
The display shows:



Press:



The display shows:

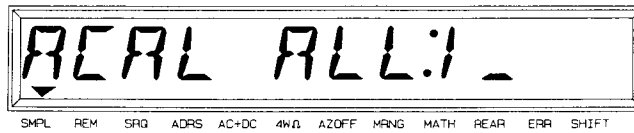


Notice that the down arrow key steps through the menu in alphabetic order.

Press:



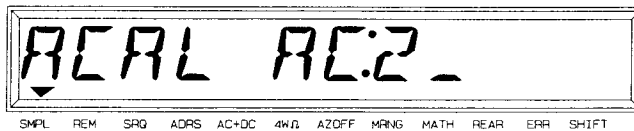
The display shows:



Press:



The display shows:



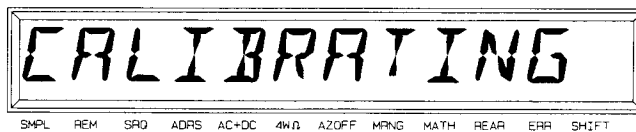
The up arrow key steps through the menu in the reverse order.

When using the up or down arrow keys and you step past the last parameter choice, a wraparound occurs to the other end of the menu.

Suppose you want to run the AC autocal routines. With the display showing *ACAL AC:2*, press:



The display shows:



It takes about 3 seconds to perform the AC autocal routine. When the routine is over the display returns to showing measurements.

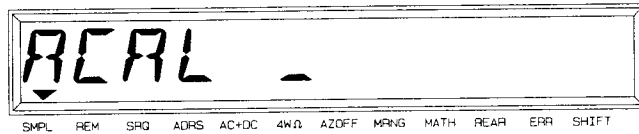


## Numeric Equivalents

While stepping through the menu, you probably noticed that the display showed both alpha and numeric characters separated with a colon (for example, AC:2). The display was showing you the two versions of the same parameter. That is, you can select AC autocal by specifying either the characters AC or the number 2. Press:



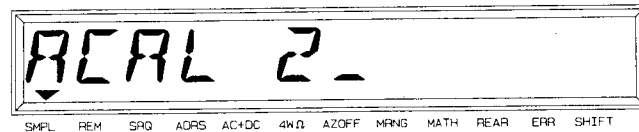
The display shows:



Press:



The display shows:



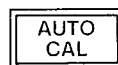
Press:



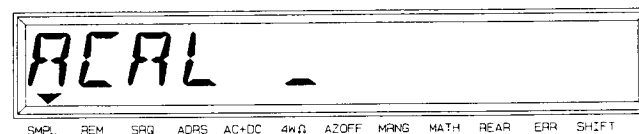
Notice that the parameters AC and 2 have the same effect. Both types of parameters are provided as a convenience. You can use whichever type you prefer.

## Default Values

Every parameter has a default value. A default value is what the HP 3457 selects if you do not specify a value. For example, the default value for the autocal parameter is ALL. Press:



The display shows:



Press:

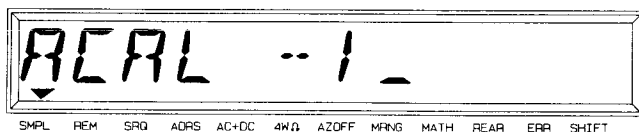


The HP 3457 is using the default value and performing all of the autocal routines. It takes about 35 seconds to perform all of the autocal routines.

You can also enter -1 to select the default value. Press:



The display shows:



Press:



The HP 3457 is again using the default value and performing all of the autocal routines.

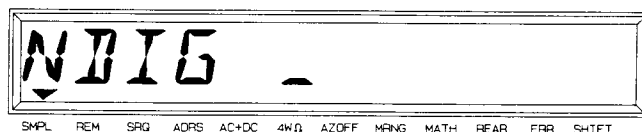
If you want to know more about the autocal function, refer to "Calibration" in Chapter 3.

## Numeric Parameters

You have just learned how to execute a command that has a menu of parameter choices. Some commands may require you to enter a numeric parameter. Do not confuse this with the numeric *equivalent* of a parameter as shown previously. A numeric parameter is the actual value used by the HP 3457. We will use the number of digits command (NDIG) to demonstrate numeric parameters. Press:



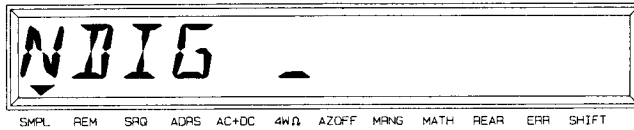
The display shows:



Press:



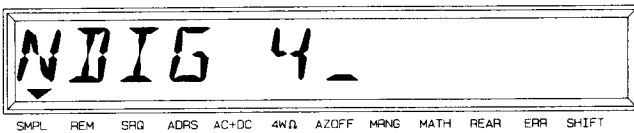
The display still shows:



Notice that when you pressed the up arrow key, no parameter choice was displayed. This means there is no menu and you must enter a number. For example, press:



The display shows:



Press:



You have now selected 4.5 digits of display resolution.

---

**NOTE**

*The extra .5 digit is always assumed when you are specifying display digits.*

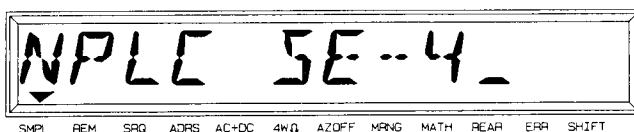
---

**Exponential Parameters**

You can also enter numeric parameters using exponential notation. We will use the number of power line cycles command (NPLC) to demonstrate exponential parameters. Press:



The display shows:



Press:

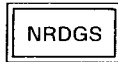


You have now selected .0005 (5E-4) power line cycles of integration time. You could also have entered .0005 as the parameter. You will learn more about power line cycles later in this chapter.

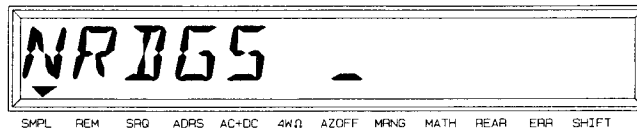
Reset the HP 3457 to return the number of power line cycles to 10.

### Multiple Parameters

You have now learned how to execute commands that have only one parameter. Many commands have two parameters, and some have three. We will use the number of readings command (NRDGS) as an example of a command with two parameters. Press:



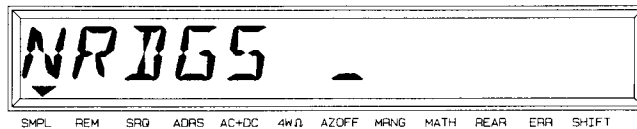
The display shows:



Press:



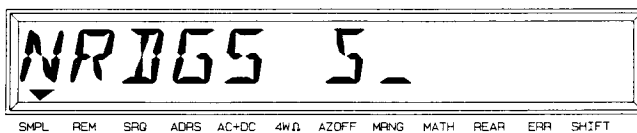
The display still shows:



Again, there is no menu for the first parameter. The first parameter in the NRDGS command determines the number of measurements made per trigger event. Press:



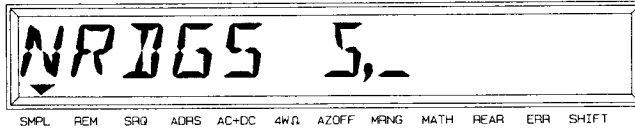
The display shows:



You must use a comma delimiter to separate parameters. Press:



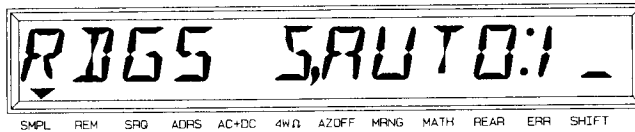
The display shows:



Press:



The display shows:



There is a menu for the second parameter. The second parameter specifies the event that initiates a measurement. As you learned before, you can step through the menu using the up or down arrow keys. When the display is showing the parameter you want (in this case, AUTO), select it by pressing:



You will learn more about the NRDGS command later in this chapter.

## Using the Alphabetic Command Directory

In addition to the configuration keys, the HP 3457 has an alphabetic command directory. This is indicated by the blue alphabet characters above the configuration keys. With the alphabetic command directory, you can access any front panel command.

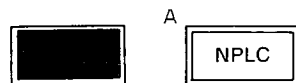
---

### NOTE

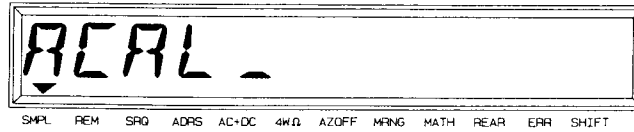
*Not all commands can be executed from the front panel. Some commands are remote only. You can find out whether a particular command is remote only, local only, or remote and local, in Chapter 4.*

---

Press:



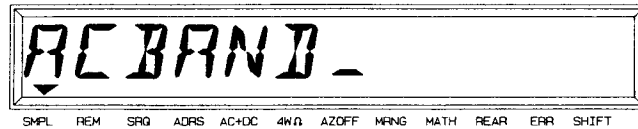
The display shows:



This is the autocal command that you previously executed using the AUTO CAL key. Notice that the HP 3457 did not place a space delimiter behind the command header as it did when you used the AUTO CAL key. Press:



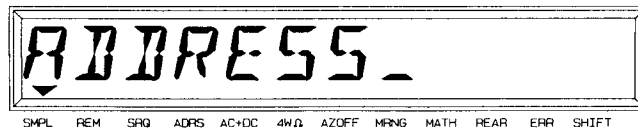
The display shows:



Press:

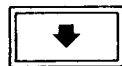


The display shows:



Notice that the down arrow key is stepping through the commands in alphabetical order. The up arrow key steps through the commands in reverse order.

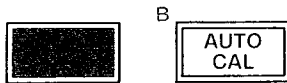
Press and hold:



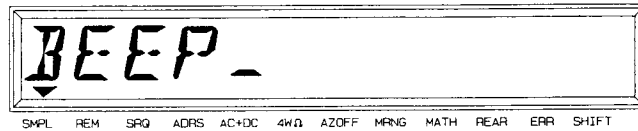
You are rapidly stepping through the alphabetic listing. Notice you can also continue into the other letters of the alphabet.

## Selecting a Command

Suppose you want to select the BEEP command. Press:



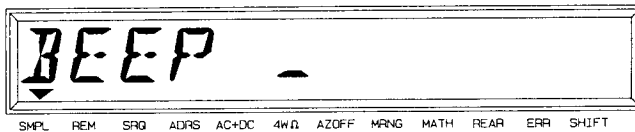
The display shows:



Now suppose you want to select a parameter. Notice that you cannot use an up or down arrow key since this steps to another command. When using the alphabetic command directory, you must place a delimiter behind the command to select it. The HP 3457 allows either a comma or a space as the delimiter between the command header and the first parameter. To enter a comma, simply press the comma key. To enter a space, press:



The display shows:

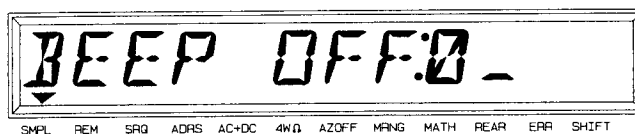


## Parameters

You can now select the first parameter. Press:



The display shows:



## Executing a Command

There is a menu of choices for the first parameter. Since the BEEP command does not have a second parameter, you select the first parameter and execute the command by pressing:



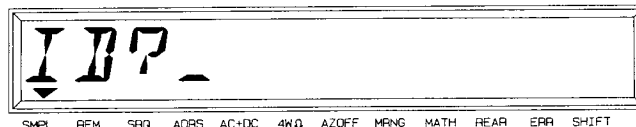
You have now shut off the beep function. The HP 3457 no longer beeps when it detects an error.

## Query Commands

There are a number of commands in the alphabetic command directory that end with a question mark. These commands are called query commands since each of them asks the HP 3457 a particular question and returns the response. Press:



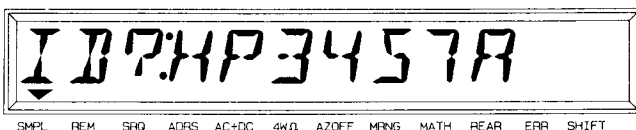
The display shows:



This is a query command that asks "what is the identity of this device?" Press:



The display shows:



## Standard Queries

The alphabetic command directory contains the following ten standard query commands:

AUXERR?	LINE?
CALNUM?	MCOUNT?
ERR?	OPT?
ID?	REV?
ISCALE?	STB?

You learned how to read the error register using the shifted ERROR key. You can also use the ERR? query command to read this register. The ERR? query command does not return a description of each error as did the shifted ERROR key. Instead, each error is assigned a weighted value and the HP 3457 returns the sum of these weights. For example, the *hardware error* has a weight of 1 and the *out of calibration error* has a weight of 512. If these are the only errors in the error register, the ERR? query returns the sum of 513.



If the error register has a *hardware error* (weight = 1), there are one or more hardware related errors stored in the auxiliary error register. You read this register using the AUXERR? query command. This command also returns a weighted sum.

If you want to know more about errors, refer to “The Error Register” or “The Auxiliary Error Register” in Chapter 3.

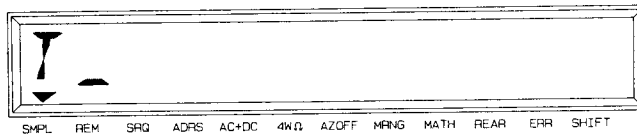
**Additional Queries** In addition to the standard queries, you can create 16 others by appending a question mark to these commands:

AZERO	NRDGS
CHAN	OCOMP
DELAY	RANGE
FIXEDZ	SLIST
LFREQ	TARM
MATH	TERM
MSIZE	TIMER
NPLC	TRIG

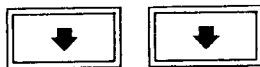
For example, press:



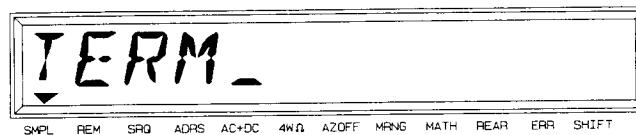
The display shows:



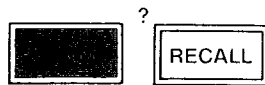
Press:



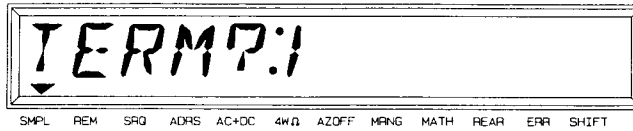
The display shows:



Press:



The display shows:



The response (1) to the TERM? command is the numerical equivalent to the TERM parameter FRONT. In other words, the HP 3457 is using its front terminals for measurements.

Remember, to clear the query and response from the display, press:



If you want to know more about the query commands, refer to the particular subject being queried in Chapter 3.

## Using the Math Functions

The math functions let you perform mathematical operations on measured readings. The math keys are shifted and are shown in Figure 2-6.

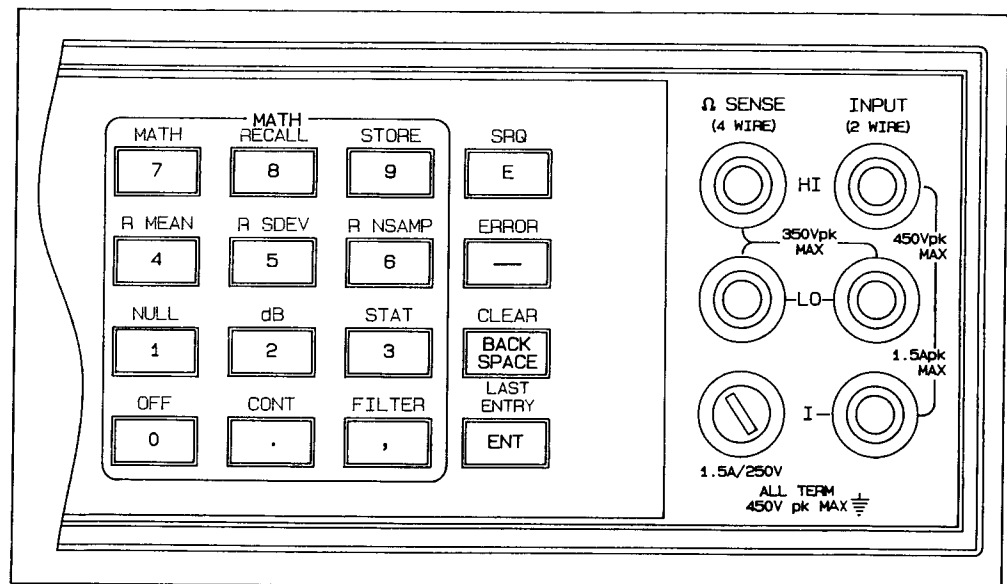
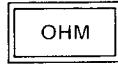


Figure 2-6. Math Keys

**NULL** You can use the NULL math operation to cancel the effects of test lead resistance for 2-wire ohms measurements.

Connect your test leads to the HI and LO INPUT terminals and connect the ends together. Press:



The HP 3457 should be displaying a small resistance. This is the resistance of your test leads. Press:



You have now enabled the NULL math function. Notice the MATH annunciator is on and the displayed resistance is much closer to zero. When you enabled the NULL operation, the HP 3457 took a reading and stored it in the *offset register*. It then subtracts that reading from each successive measurement. In this case, you have effectively cancelled the resistance of your test leads. You can use the NULL operation on any measurement function (DC voltage, AC current, and so on).

**MATH OFF** To shut-off a math operation, press:



The NULL operation is cancelled, the MATH annunciator is off, and the test lead resistance is again displayed.

**MATH CONT** You can restore a previously selected math operation by pressing:



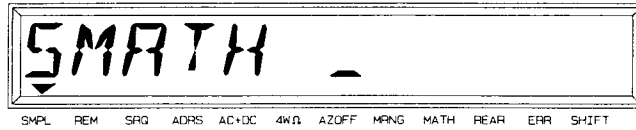
The MATH annunciator is on and the display is once again showing readings with the test lead resistance cancelled.

## Presetting Registers

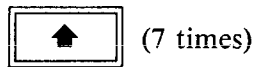
You can also preset math registers. For example, we will place the value of 10 in the *offset register*. Press:



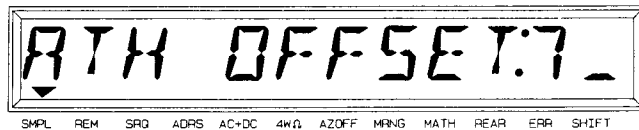
The display shows:



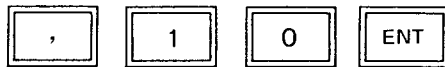
Press:



The display shows:



Press:



The HP 3457 is now subtracting 10 ohms from each reading and the display should be showing negative resistance measurements.

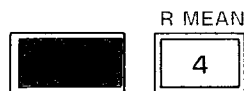
## Statistics

Some math functions do not alter measured readings but store information concerning those readings. For example, press:



You have enabled the statistics math function. Statistics keeps a running calculation of the mean, standard deviation, and the number of readings made on the present series of measurements.

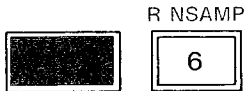
To display the mean, press:



To display the standard deviation, press:



To display the number of readings sampled, press:



In most cases, you would suspend measurements before accessing the statistics registers. You will learn how to suspend measurements later in this chapter in “Triggering Measurements.”

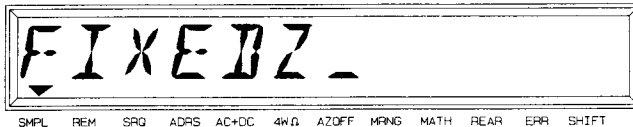
If you want to know more about the math functions, refer to “Math Functions” in Chapter 3, Functions and Features.

## Display Control

Sometimes when entering information from the front panel, you will make a mistake. This may be because you chose the wrong command or parameter, or you started on something and then decided not to do it. Also, there are times when there may be more characters in a command string or a displayed reading than the display can show. We will use the FUNC command to demonstrate how to control the display. Press:



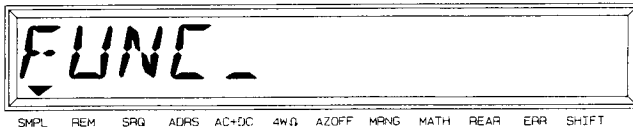
The display shows:



Press:



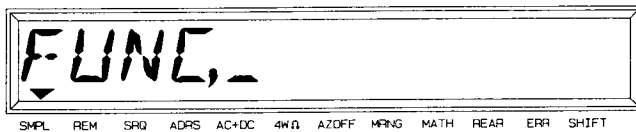
The display shows:



Press:



The display shows:



Press:



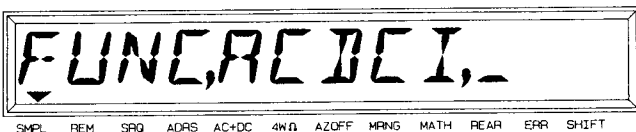
The display shows:



Press:



The display shows:



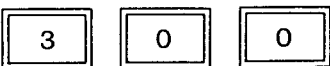
Press:



The display still shows:



There is no menu for the second parameter. The second parameter selects the range of the measurement. Press:



The display shows:

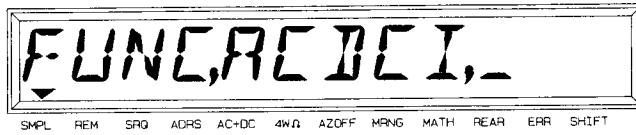


## Correcting Mistakes

You made a mistake, there is no 300 amp range. To correct the display, press:

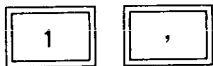


The display shows:



You can now enter a correct number for the maximum input parameter.

Press:



The display shows:



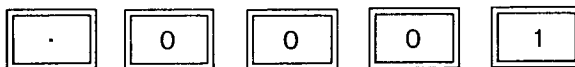
Press:



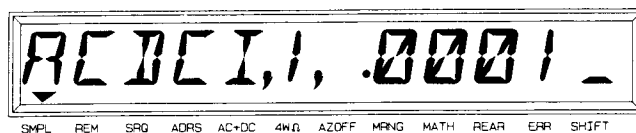
The display shows:



There is no menu for the third parameter. The third parameter determines the measurement resolution. Press:

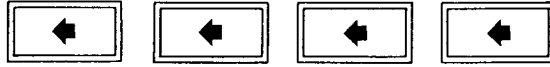


The display shows:

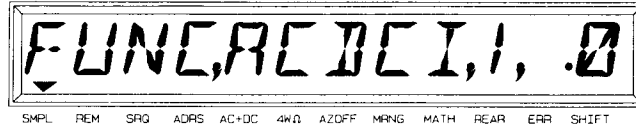


## Viewing Long Displays

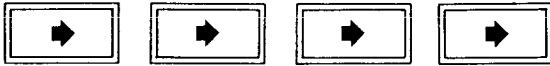
Notice that the command header (FUNC) is no longer displayed. You can view information that contains more than 12 characters using the left or right arrow keys. Press:



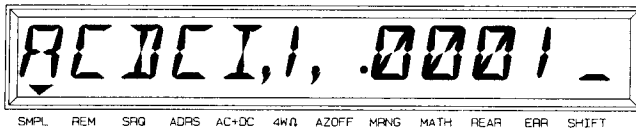
The display shows:



Press:



The display again shows:



If the arrow keys seem to move the information the wrong way, think of the display as a window you can move to the left or right using the arrow keys.

To execute the command, press:

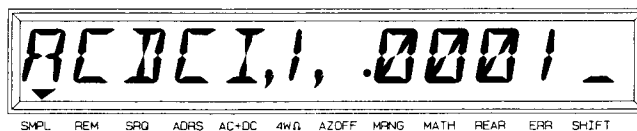


## Last Entry

You can easily recall the last executed command without repeating the command entry process. Press:



The display shows:



You can now modify the displayed command and re-execute.



## Clearing the Display

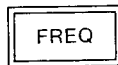
If you decide you do not want to execute this command, press:



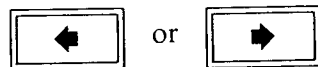
This clears the display and returns it to displaying readings.

## Viewing Extra Information

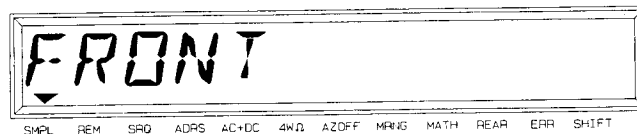
When the HP 3457 is making any type of measurement (DC voltage, AC current, and so on) and the display is showing readings or OVLD, extra information is available. This information pertains to the HP 3457's present configuration. For example, press:



The display shows frequency readings. Now press:



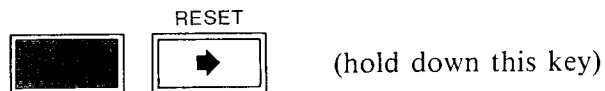
The display shows which terminals are selected. A typical display is:



You can also view extra information on error messages, when recalling readings, responses to some query commands, and so on.

## Display Test

You can test all display segments by pressing the SHIFT key followed by holding down the RESET key. Press:



The display shows:



# Operating from Remote

With the exception of display editing, everything that you learned to do from the front panel can also be done from remote. There are, however, slight differences in operation. This section shows you the fundamentals of operating the HP 3457 from remote.

## Enter/Output Statements

The statements you use to operate the HP 3457 from remote depend on your computer and its language. In particular, you need to know the statements your computer uses to enter and output information. For example, the enter statement for a computer that uses an HP BASIC language is:

ENTER

The output statement is:

OUTPUT

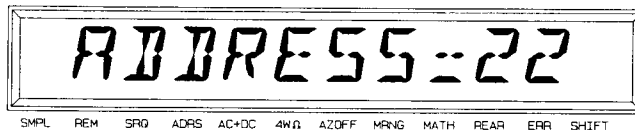
Read your computer manuals to find out which statements you need to use. The examples used in this manual are primarily for Hewlett-Packard Series 80 or Series 200 computers using HP BASIC language.

## Reading the HP-IB Address

Before you can operate the HP 3457 from remote, you need to know its HP-IB address. The address was displayed during the power-on sequence. If you cannot recall the address, press:



A typical display is:



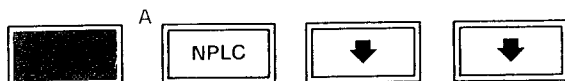
The displayed response is the device address. When sending a remote command, you append this address to the HP-IB interface's select code (normally 7). For example, if the select code is 7 and the device address is 22, the combination is 722.

## Changing the HP-IB Address

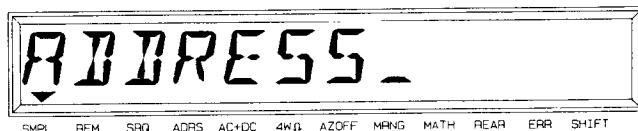
### NOTE

All examples in this manual assume an HP-IB address of 22. We recommend you retain address 22 to simplify programming.

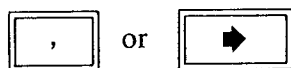
Every device on the HP-IB bus must have a unique address. If you need to change the HP 3457's address, press:



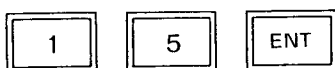
The display shows:



Press:



You can now enter the new address. For example, press:



You have now changed the address from 22 to 15. If you want to change the address back to 22, repeat the above procedure but use 22 instead of 15 in the last step.

## Sending a Remote Command

To send the HP 3457 a remote command, combine your computer's output statement with the HP-IB select code, the device address, and finally, the HP 3457 command. For example, to make the HP 3457 beep, send:

```
OUTPUT 722;"BEEP"
```

Notice the display's REM and ADRS annunciators are on.

## Getting Data from the HP 3457

The HP 3457 is capable of outputting measured readings and responses to queries. As an example, have the HP 3457 generate a response to a query by sending:

```
OUTPUT 722;"ID?"
```

When you send a query from remote, the HP 3457 does not display the response as it did when you executed the command from its front panel. Instead, the HP 3457 sends the response to its output buffer. The output buffer is a register that holds information until it is read by the computer or replaced by new information.

---

### NOTE

*On an HP Series 200 computer, the A variable must be in context before you do the following steps. That is, you must run a program that declares the A variable. Refer to your computer's operating manual for more information.*

---

Use your computer's enter statement to get the response from the output buffer. For example, execute:

```
ENTER 722;A
```

Followed by:

```
DISP A
```

The first statement enters whatever is in the HP 3457's output buffer into the computer's A variable. The second statement displays the A variable's contents (3457) on the computer's display.

You use the same technique to get readings from the HP 3457. Whenever the HP 3457 is making measurements, you can get a reading by sending:

```
ENTER 722;A
```

Followed by:

```
DISP A
```

Your computer is now displaying the reading.

---

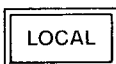
**NOTE**

*From remote, the HP 3457 indicates an overload condition by outputting 1E38 instead of a reading.*

---

## **The LOCAL Key**

If you press a key on the HP 3457's keyboard after operating it from remote, it does not respond. This means the HP 3457 is in the remote mode (as indicated by the display's REM annunciator) and is ignoring its keyboard. To return it to the local mode, press:



## Often-Used Commands

The HP 3457's command set contains over ninety commands that allow you to configure the HP 3457 for a variety of applications. Within that command set, however, is a small subset of commands that are all you need for most applications. These commands are:

TEST	ACDCI
ERR?	OHMF
RESET	FREQ
DCV	PER
ACV	NPLC
OHM	TRIG
ACDCV	PRESET
DCI	STB
ACI	ID?

Many of these commands perform “overhead” functions such as self-test, reading the error register(s), RESET, PRESET, and reading the status byte. The remaining commands pertain to making measurements such as selecting the measurement function, range and resolution, setting the number of power line cycles, and triggering measurements.

This section discusses each of the above commands with the exception of the ID? command which was discussed previously in “Getting Data from the HP 3457.” If, after reading this section, you want to know more information about a particular command, refer to Chapter 4.

**Self-Test** To run the complete self-test, send:

```
OUTPUT 722;"TEST"
```

When you issue the self-test command from remote, the HP 3457 does not display whether the test passed or failed. You must determine the results of self-test by reading the error register(s).

**Reading the Error Register(s)** To read the error register, send:

```
OUTPUT 722;"ERR?"
```

Remember, to get the error data, execute:

```
ENTER 722;A
```

```
DISP A
```

The ERR? query command returns the weighted sum of the error conditions. If no errors have occurred, the ERR? command returns 0. After you read the error register, the HP 3457 clears the register and shuts off the display's ERR annunciator.

If a hardware error has occurred (weight = 1), there are one or more errors stored in the auxiliary error register. To access this register, send:

```
OUTPUT 722;"AUXERR?"
```

You enter the data as you did with the preceding ERR? command. Errors in the auxiliary error register are also assigned weighted values. After you read the auxiliary error register, it is cleared by the HP 3457.

If you want to know more about errors, refer to "The Error Register" or "The Auxiliary Error Register" in Chapter 3.

## **RESET**

The RESET command can be used from remote although it is primarily for front panel use. Reset configures the HP 3457 to a good starting point for local operation.

When attempting to reset from remote, it is possible that the HP 3457 is busy or the HP-IB interface is being held. In either case, the HP 3457 will not immediately respond to the remote RESET command. For this reason, you should always send the HP-IB device clear command before you send the RESET command. The HP 3457 always responds immediately to the device clear command. You send the two commands as follows:

```
CLEAR 722
```

```
OUTPUT 722;"RESET"
```

## **Measurement Functions**

To select DC voltage measurements, send:

```
OUTPUT 722;"DCV"
```

Notice that the HP 3457 displays the measurement function and measured readings as well as sending the readings to its output buffer.

To select AC voltage measurements, send:

```
OUTPUT 722;"ACV"
```

To select 2-wire ohms measurements, send:

```
OUTPUT 722;"OHM"
```

To select AC + DC voltage measurements, send:

```
OUTPUT 722;"ACDCV"
```

To select DC current measurements, send:

```
OUTPUT 722;"DCI"
```

To select AC current measurements, send:

```
OUTPUT 722;"ACI"
```

To select AC + DC current measurements, send:

```
OUTPUT 722;"ACDCI"
```

To select 4-wire ohms measurements, send:

```
OUTPUT 722;"OHMF"
```

To select frequency measurements, send:

```
OUTPUT 722;"FREQ"
```

To select period measurements, send:

```
OUTPUT 722;"PER"
```

**Range  
Parameter**

You can add a parameter to each of the above function commands to select the measurement range. This parameter is called *max. input* since you specify it as the input signal's maximum expected amplitude (or the maximum resistance for ohms measurements). The HP 3457 then chooses the correct range. For example, if you are measuring AC voltage with a maximum value of 10 volts, send:

```
OUTPUT 722;"ACV 10"
```

Notice that this example has a space delimiter between the command header and the *max. input* parameter. You can use either a space or a comma as the delimiter between the command header and the first parameter.



---

**NOTE**

*For frequency and period measurements, the max. input parameter specifies the maximum amplitude of the input signal. It does not specify the frequency range (Hz) or the period range (seconds).*

---

The default value for *max. input* selects autorange (see “Defaulting Parameters” on the next page).

**Resolution  
Parameter**

On all of the above function commands, except *FREQ* and *PER*, you can also add a second parameter that selects the resolution. This parameter is called *% resolution* since you specify it as a percentage of the *max. input* parameter. The HP 3457 multiplies *% resolution* times *max. input* to determine the measurement’s resolution. For example, suppose your maximum expected input is 10 VAC and you want 1 mVAC of resolution. To determine the *% resolution* parameter, use the equation:

$$\% \text{ resolution} = (\text{actual resolution}/\text{maximum input}) \times 100$$

For this example, the equation evaluates to:

$$\% \text{ resolution} = (.001/10) \times 100 = .0001 \times 100 = .01$$

The HP 3457 changes the resolution by changing the amount of time during which it samples the input signal (integration time). The *NPLC* command also affects the integration time. To allow the *% resolution* parameter to control the integration time, set *NPLC* to 0 before you send the function command. Send:

```
OUTPUT 722;"NPLC 0"
```

You will learn more about the *NPLC* command later in this chapter under “Setting the Number of Power Line Cycles.”

You can now send the function command:

```
OUTPUT 722;"ACV 10,.01"
```

Notice that a comma separates the two parameters. A comma is the only delimiter that can be used to separate parameters.

If you use the default value for *% resolution*, the *NPLC* command determines the integration time and the resolution.

## **Defaulting Parameters**

The front panel method of defaulting a parameter (omitting the parameter or using -1) can also be used from remote. For example, to specify 10 for the first parameter and default the second, send:

```
OUTPUT 722;"ACV 10"
```

Or:

```
OUTPUT 722;"ACV 10,-1"
```

In addition, from remote only, you can use two commas to indicate a default value. For example, To specify 10 for the first parameter and default the second parameter, send:

```
OUTPUT 722;"ACV 10,,"
```

To default the first parameter and specify .01 for the second, send:

```
OUTPUT 722;"ACV ,,.01"
```

Notice in the above example, a space comes before the two commas. If you omit the space, you can default the first parameter and specify the second by sending:

```
OUTPUT 722;"ACV,,.01"
```

## **Setting the Number of Power Line Cycles**

The HP 3457 samples the signal being measured for a period of time based on the power line frequency. You specify this time as the number of power line cycles (PLCs) of the line frequency. The PLCs are indirectly responsible for the measurement speed, the maximum digits of resolution, and the amount of normal mode rejection (ability to reject the line frequency from the measurement). The power-on value for PLCs is 10. This provides a good compromise between measurement speed and resolution. To see what happens when you set the number of PLCs to a minimum, send:

```
OUTPUT 722;"NPLC .0005"
```

Notice that the NPLC command overrides the resolution previously specified in one of the function commands (DCV, ACV, etc.). Notice also the displayed digits of resolution decreases. The measurement speed has also increased although you cannot see it since the display and its SMPL annunciator cannot track readings that fast. Return the PLCs to 10 by sending:

```
OUTPUT 722;"NPLC 10"
```

If you want to know more about power line cycles and their relationship to normal mode rejection, refer to “The A/D Converter” in Chapter 3.

## Triggering Measurements

Before a measurement can be made, it must be triggered by some event. For the measurements you have made up to now, the HP 3457 has been triggering automatically. When the trigger event is automatic, the HP 3457 makes a measurement whenever it is not busy doing something else. You can stop making automatic measurements by setting the trigger event to HOLD. Send:

```
OUTPUT 722;"TRIG HOLD"
```

Notice that the HP 3457 stopped making measurements and the display's SMPL annunciator quit flashing. This is the most commonly used method to suspend measurements. Return the trigger event to auto by sending:

```
OUTPUT 722;"TRIG AUTO"
```

**Single Trigger** You can trigger the HP 3457 once by setting the trigger event to single. To do this send:

```
OUTPUT 722;"TRIG SGL"
```

Notice that the HP 3457 makes one measurement, then holds.

## Synchronous Trigger

You can synchronize the HP 3457 to your computer by setting the trigger event to synchronous (SYN). In the synchronous trigger mode, the trigger event is satisfied whenever the HP 3457's output buffer is empty and the computer requests data.\* The HP 3457 then holds the HP-IB bus until the measurement is complete and the reading has been sent to the computer. This means that measurements are made whenever the computer wants them. This is a very important feature for remote operation. The following program shows a typical measurement sequence using synchronous trigger.

```
10 OUTPUT 722;"TRIG SYN"  
20 OUTPUT 722;"DCV"  
30 FOR I = 1 TO 20  
40 ENTER 722;A  
50 DISP A  
60 NEXT I  
70 END
```

In the above program, line 10 selects the synchronous trigger mode. Line 20 selects DC voltage measurements. The range and resolution parameters are omitted (defaulted) so the HP 3457 uses autorange and the resolution is

\*The HP 3457's reading memory must be off or empty in the synchronous trigger mode. You will learn about reading memory later in this chapter.

determined by the present setting of the NPLC command. Lines 30 and 60 establish a for/next loop that cycles through lines 40 and 50 twenty times. Line 40 requests data from the HP 3457. This satisfies the synchronous trigger and initiates a measurement. The HP 3457 then holds the bus until the reading is ready. When the reading is ready, it is placed in the computer's A variable. Line 50 then displays the reading. This sequence repeats until 20 readings have been taken.

## **PRESET**

The PRESET command is similar to the RESET command. However, the PRESET command is primarily for remote operation and selects the most often-used remote parameters. These parameters include synchronous triggering and one power line cycle of integration time. In addition, the PRESET command takes less time to execute than the RESET command.

As was the case with the RESET command, it is a good idea to send the device clear before you send PRESET. You send the two commands as follows:

```
CLEAR 722
```

```
OUTPUT 722;"PRESET"
```

## **Reading the Status Register**

The status register contains seven bits that monitor various instrument conditions. The bits are weighted and indicate conditions such as; program memory execution complete, ready for instructions, error occurred, and HP-IB service request information.

With the STB? command, you can read this register and determine which conditions have occurred. To read the status register, send:

```
OUTPUT 722;"STB?"
```

followed by:

```
ENTER 722;A
```

```
DISP A
```

Your computer will display the weighted sum of all set bits. For example, a displayed value of 36 indicates that the front panel SRQ key has been pressed (weight = 4) and an error has occurred (weight = 32). If no bits are set, the STB? command returns 0.

If you want to know more about the status register or the bits and their weights, refer to "Status Register" in Chapter 3.

# Additional Functions

This section describes some additional commonly used functions.

## Using the Rear Terminals

Any measurement that can be made using the front terminals can also be made using the rear terminals. The connections for the various types of measurements are shown in Figure 2-7.

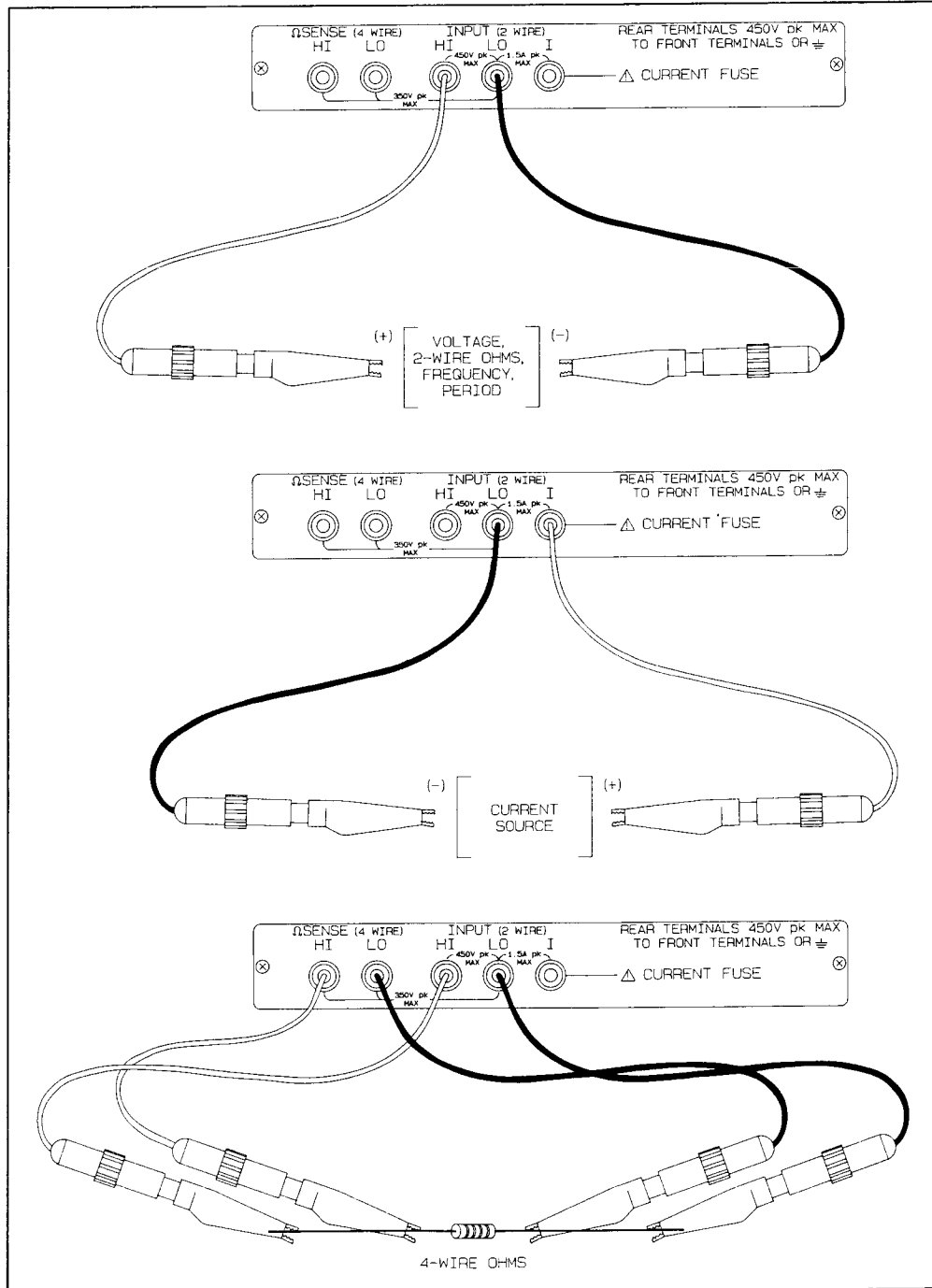


Figure 2-7. Rear Terminal Connections

Return the HP 3457 to the power-on state by sending:

```
OUTPUT 722;"RESET"
```

To select the rear terminals, send:

```
OUTPUT 722;"TERM REAR"
```

Notice the display's REAR annunciator is on.

To return to using the front terminals, send:

```
OUTPUT 722;"TERM FRONT"
```

You can also use the TERM command to disconnect all inputs from the HP 3457 or to select an optional plug-in card. You can find more information on using a plug-in card in Chapter 5.

## Digits Displayed

When the HP 3457 is displaying measurements, you can vary the number of digits it displays. The power-on value for number of digits is 5.5. In the power-on state, you can view one more digit by sending:

```
OUTPUT 722;"NDIG 6"
```

---

### NOTE

*The extra .5 digit is always assumed when you are specifying display digits.*

---

The NDIG command only masks digits from the display. It does not affect readings transferred over the HP-IB bus in any way. Also, you cannot view more digits than are being resolved by the HP 3457.

## Range Commands

You have learned how to select the range using the first parameter in any of the function commands. You can also use the following commands to control the range.

To disable autorange and hold the present range, send:

```
OUTPUT 722;"ARANGE OFF"
```

To enable autorange, send:

```
OUTPUT 722;"ARANGE ON"
```

To manually select a range, use the RANGE command and specify the first parameter as the maximum expected input signal (or the maximum resistance for ohms measurements). The HP 3457 then selects the correct range. For example, if you are measuring voltage with a maximum level of 25 volts, send:

```
OUTPUT 722;"RANGE 25"
```

You can also add a second parameter to select the measurement resolution. This parameter functions exactly as the *% resolution* parameter in the function commands (see "Resolution Parameter," earlier in this chapter).

Reduce the number of PLCs by sending:

```
OUTPUT 722;"NPLC 0"
```

Now, to select a maximum input of 25 V and 1 mV of resolution, send:

```
OUTPUT 722;"RANGE 25,.004"
```

The HP 3457 multiplies the first parameter times the the second parameter (in percent) to determine the resolution. In this case,  $25 \times .00004 = .001 = 1 \text{ mV}$ .

**Delay** You can insert a delay between each trigger and the first measurement using the DELAY command. First, set trigger to HOLD by sending:

```
OUTPUT 722;"TRIG HOLD"
```

Specify a 10 second delay by sending:

```
OUTPUT 722;"DELAY 10"
```

Now send:

```
OUTPUT 722;"TRIG SGL"
```

Watch the display's SMPL annunciator for the indication of a measurement. Notice that the HP 3457 waits 10 seconds from the time it receives the single trigger until it makes a measurement.

Return the delay to the default value by sending:

```
OUTPUT 722;"DELAY"
```

---

#### NOTE

*The default delay is determined by the present measurement function, number of PLCs and so on. If you specify less than the default delay, the HP 3457 may not have enough time to make accurate measurements. For this reason, it is best to use the default delay parameter to “shut off” the delay function.*

---

## Number of Readings

You can use the first parameter in the NRDGS command to make more than one measurement for each trigger event. In addition, the NRDGS command has a second parameter that specifies the sample event. In operation, the trigger event must occur first followed by the sample event. After both events have occurred, the HP 3457 performs the specified measurement(s). For example, send:

```
OUTPUT 722;“NRDGS 5,SYN”
```

Now set triggering to automatic by sending:

```
OUTPUT 722;“TRIG AUTO”
```

By sending TRIG AUTO, you have triggered the HP 3457. Notice, however, that it is not making measurements. The HP 3457 will not make a measurement until a synchronous sample event occurs. To satisfy the synchronous event, send:

```
ENTER 722;A,B,C,D,E
```

This line generates 5 SYN events since the computer needs data for all 5 variables. The first reading is placed in the A variable, the second in the B variable, and so on.

## Reading Memory

You can store readings in the HP 3457’s memory and recall them later. You have two choices for storing readings, first-in-first-out (FIFO) and last-in-first-out (LIFO). In the FIFO mode, the first reading stored is the first reading recalled when you recall the readings from remote. In LIFO, the last reading is the first reading recalled. To set up reading memory using FIFO as an example, send:

```
OUTPUT 722;“MEM FIFO”
```

Each reading will now be stored in memory.



## Recalling Readings

You can recall readings using the “implied read” or with the RMEM command. The implied read occurs when the HP 3457’s output buffer is empty and the computer requests data. When this happens, the HP 3457 removes a reading from memory and places it into the output buffer. The reading is then immediately sent to the computer. The HP 3457 determines which reading to place in the output buffer based on the memory format you specified; FIFO = the oldest reading, LIFO = the newest reading. Run the following program to see a typical application using implied read:

```
10 CLEAR 722
20 OUTPUT 722;"PRESET"
30 OUTPUT 722;"MSIZE 200"
40 OUTPUT 722;"MEM FIFO"
50 OUTPUT 722;"NRDGS 15,AUTO"
60 OUTPUT 722;"TRIG SGL"
70 FOR I = 1 TO 15
80 ENTER 722;A
90 DISP A
100 NEXT I
110 END
```

In the above program, line 10 clears the HP 3457. Line 20 presets the HP 3457. Among other things, this selects DC voltage measurements and temporarily suspends triggering by setting the trigger event to synchronous. Line 30 allocates 200 bytes of reading memory. Line 40 enables the first-in-first-out mode of reading memory. Line 50 selects 15 measurements and sets the sample event to auto. Line 60 sets the trigger event to single and initiates measurements. Lines 70 and 100 set up a for/next loop that cycles through lines 80 and 90 fifteen times. Line 80 generates the implied read. Whenever this line is encountered, it removes the oldest reading from memory and places it in the computer’s A variable. Line 100 displays the A variable’s contents. This sequence repeats until all 15 readings are removed from memory and displayed. In this example, the readings are displayed in the same order they were made, that is, the first reading taken is the first reading displayed. It is important to remember that the “implied read” removes (clears) readings from memory.

## RMEM Command

You can access readings in memory, by reading number, using the RMEM command. This method does not remove readings from memory, it merely copies them from memory to the output buffer. In other words, RMEM does not clear readings from memory. Reset the HP 3457 and enable reading memory by sending:

```
OUTPUT 722;"RESET"

OUTPUT 722;"MEM LIFO"
```

Regardless of the memory format (FIFO or LIFO), the most recent reading is assigned the lowest number (1) and the first reading has the highest number. To use the RMEM command to recall the fifth reading from the most recent, send:

OUTPUT 722;"RMEM 5"

You can enter and display the reading by sending:

ENTER 722;A

DISP A

---

**NOTE**

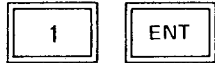
*From remote, you can also add parameters specifying the number of readings you want to recall and from which record (group of readings). These are discussed under "RMEM" in Chapter 4.*

---

From the front panel, recall a reading by pressing:



You now enter the number of the reading you want to recall. For example, press:



The most recent reading is displayed. Once you have a reading displayed, you can step to the other readings using the up or down arrow keys. Notice that when you recall readings, the HP 3457 stops storing new readings and preserves old readings.

To continue storing readings without destroying the old ones, send:

OUTPUT 722;"MEM CONT"

If you want to know more about reading memory, refer to "Memories" in Chapter 3.

## State Memory

You can store the HP 3457's present configuration (trigger mode, number of power line cycles, measurement function, memory conditions, and so on) in state memory. Later, you can easily recall that configuration. For example, to store a state, send:

```
OUTPUT 722;"SSTATE 1"
```

You have just stored the present configuration in memory location 1. Locations 1 through 10 are non-volatile memory locations. That means the states will not be lost when power is removed. To recall the state you just stored, send:

```
OUTPUT 722;"RSTATE 1"
```

An additional feature of the HP 3457 is state location 0. Whenever power is shut off or removed, the present state is immediately stored in state location 0. This means that after power has been accidentally interrupted, you can retrieve the state by sending:

```
OUTPUT 722;"RSTATE 0"
```

If you want to know more about state memory, refer to "Memories" in Chapter 3.

## Temperature Measurements

The FTHRM and CTHRM math functions allow you to make Fahrenheit or Celsius temperature measurements from a thermistor.

To perform this example you need a 5 kohm thermistor (HP part number 0837-0164). Connect the thermistor to the INPUT terminals (the ones used for 2-wire ohms). Send:

```
OUTPUT 722;"RESET"
```

```
OUTPUT 722;"OHM"
```

The HP 3457 autoranges to the 30 kohm range. This is the proper range for thermistor measurements. To stop autoranging and hold the present range, send:

```
OUTPUT 722;"ARANGE OFF"
```

To enable a temperature measurement function, send:

```
OUTPUT 722;"MATH FTHRM"
```

The HP 3457 is now displaying the thermistor's Fahrenheit temperature.

You have learned the basics of operating your HP 3457. You can now use chapters 3 and 4 to increase your knowledge and gain the fullest use from your HP 3457. For example, suppose you have a particular task in mind and you need to know how the HP 3457 performs that task and which command(s) to use. Look up your task by its title in Chapter 3, Functions and Features. You will find the details concerning the task and which command(s) to use. You can then learn about the details concerning the command(s) in Chapter 4, Command Reference.



# CONTENTS

	Page		Page
Introduction.....	3-1	Single Integer.....	3-29
Input Terminals.....	3-1	Double Integer.....	3-30
Plug-In Cards.....	3-2	Single Real.....	3-31
HP 44491.....	3-2	Two's Complement Binary Coding.....	3-33
HP 44492.....	3-2	Memories.....	3-34
Plug-In Card Commands.....	3-3	Reading Storage.....	3-34
Measurements in General.....	3-4	ASCII.....	3-34
The A/D Converter.....	3-4	Single Integer.....	3-35
Reference Frequency.....	3-4	Double Integer.....	3-35
Integration Time.....	3-4	Single Real.....	3-36
Resolution.....	3-5	Recalling Readings.....	3-37
Range.....	3-6	Subprogram Storage.....	3-38
Autozero.....	3-6	State Storage.....	3-40
Voltmeter Complete.....	3-6	Triggering.....	3-40
Predefined States.....	3-6	The Trigger Arm Event.....	3-40
Power-On State.....	3-6	The Trigger Event.....	3-41
Reset and Preset States.....	3-6	The Sample Event.....	3-41
Clearing the HP 3457.....	3-7	Event Choices.....	3-41
Voltage Measurements.....	3-8	AUTO.....	3-41
DC Voltage Measurements.....	3-9	EXT.....	3-41
Input Impedance.....	3-9	SYN.....	3-42
AC and AC+DC Voltage Measurements.....	3-10	SGL.....	3-42
Resistance Measurements.....	3-12	HOLD.....	3-42
2-Wire Ohms.....	3-12	TIMER.....	3-43
4-Wire Ohms.....	3-14	Delay.....	3-43
Offset Compensation.....	3-16	Triggering Tips.....	3-45
Current Measurements.....	3-17	Triggering Examples.....	3-46
DC Current Measurements.....	3-18	Example #1.....	3-46
AC and AC+DC Current Measurements.....	3-18	Example #2.....	3-46
Frequency and Period Measurements.....	3-20	Example #3.....	3-47
Math Operations.....	3-22	Maximizing Throughput.....	3-50
Turning Math Off and On.....	3-22	Self-Tests.....	3-50
NULL.....	3-22	The Power-On Self-Test.....	3-50
SCALE.....	3-23	The Complete Self-Test.....	3-50
Percent.....	3-24	Calibration.....	3-51
DB.....	3-25	The Status Register.....	3-52
DBM.....	3-25	The Error Register.....	3-54
FILTER.....	3-25A	The Auxiliary Error Register.....	3-55
RMS.....	3-25B	The Front Panel.....	3-56
Temperature Measurements.....	3-26	The Keyboard.....	3-57
Statistics.....	3-27	The LCD Display.....	3-57
Pass/Fail.....	3-27	Power-on Mode.....	3-57
Extra Resolution.....	3-27	Display Control.....	3-58
Buffers.....	3-28	HP-IB Address.....	3-58
The Input Buffer.....	3-28	Identity.....	3-58
The Output Buffer.....	3-29	Beeps and Tones.....	3-59
ASCII.....	3-29		

# Functions and Features

---

## Introduction

This chapter discusses the HP 3457's measurement functions and operating features such as DC voltage measurements, 4-wire ohms, triggering, buffers, and math operations. Use this chapter as a starting point before attempting to solve your particular application. For example, assume you want to make DC voltage measurements, trigger the measurements externally, and perform statistical calculations on the readings. The three subjects are: DC voltage measurements, triggering, and statistics. In this chapter, you will find a discussion of each subject and a summary of the applicable commands. Next, you can use the Command Reference (chapter 4) to learn the details concerning the commands.

## Input Terminals

The HP 3457 contains a front and a rear set of terminals for measurement connections. The rear terminals can be replaced with an optional plug-in card. The TERM command allows you to select the front or rear terminals, or a plug-in card. Additionally, the TERM command can open all inputs to the HP 3457. The TERM? query command reveals which terminals are presently selected. The HP 3457's front and rear terminals are shown in Figure 3-1.

The maximum input current to either the front or rear current input terminals is 1.5 amps from a 250 volt source. Current inputs are fuse protected.

The maximum input voltage for the remaining terminals is:

HI to LO INPUT terminals: +/- 450 V peak  
HI or LO terminal to earth ground: +/- 450 V peak  
HI  $\Omega$  SENSE to LO  $\Omega$  SENSE: +/- 350 V peak  
HI or LO  $\Omega$  SENSE to LO INPUT: +/- 350 V peak  
Front terminals to rear terminals: +/- 450 V peak

## CAUTION

Damage will occur to the HP 3457 if you exceed any of the above voltage limits.

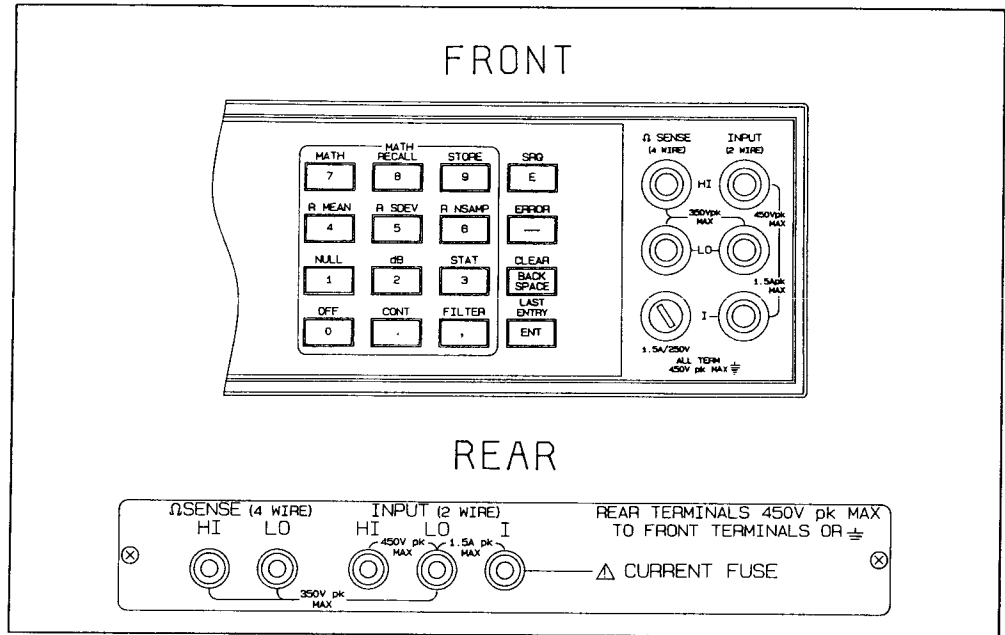


Figure 3-1. Measurement Terminals

## Plug-In Cards

Two optional plug-in cards are available for the HP 3457; the HP 44491 and the HP 44492. For more information about plug-in cards, refer to Chapter 5.

**HP 44491** This card can be configured as eight 2-wire channels, four 4-wire channels, or any combination of both. In addition, two 2-wire channels are available for measuring current or for use as actuator switches. You determine whether the channels are 2-wire, 4-wire, current input, or actuator output by the channel numbers you use when sending commands. You do not need to modify the hardware to configure channels.

**HP 44492** This card has ten 2-wire channels that can be used for any type of measurement except current and 4-wire ohms. Its maximum switching rate is 300 closures per second.



## Plug-In Card Commands

The following six commands are exclusively for use with a plug-in card. The plug-in card must be selected using the TERM command before measurements can be made from that card.

OPT?—indicates the type of plug-in card or terminals present in the HP 3457's rear slot.

CRESET—sets the plug-in card to a known state. It opens all relays and, if applicable, suspends channel scanning (SADV HOLD). This command is automatically executed whenever you turn on the HP 3457's power.

CHAN—selects a channel for measurements. Any previous channel is first disconnected (except for closed actuator channels on the HP 44491 plug-in card) before the specified channel is connected.

CHAN?—reveals the channel number presently selected.

OPEN—opens the specified actuator channel on the HP 44491 plug-in card. You can also use OPEN to insert a 1.2 second interval between successive openings and closings of an actuator channel. This protects the contacts when switching currents near the relay's maximum rating.

CLOSE—closes the specified actuator channel on the HP 44491 plug-in card.

SLIST—allows you to create a list of channels to be scanned sequentially.

SLIST?—reveals the number of channels in a scan list when executed from remote or the actual channels in the list when executed from the HP 3457's keyboard.

SADV—designates the event that causes an advance to the next channel in a scan list (SLIST).

# Measurements in General

The HP 3457 measures an analog signal (AC voltage, DC voltage, and so on) by converting it to a digital value. Once the signal is in digital form, it can be displayed, sent over the HP-IB bus, inserted into a mathematical algorithm and so on. Input signals are converted to digital values by the HP 3457's A/D (analog to digital) converter.

## The A/D Converter

The A/D converter is responsible for many of the HP 3457's operating characteristics. These characteristics include AC line rejection (ability to reject signals at the power line frequency from measurements), measurement speed, resolution, and accuracy.

## Reference Frequency

When power is applied, the HP 3457 automatically measures the power line frequency as being 50 Hz, 60 Hz, or 400 Hz. The A/D converter then sets its *reference frequency* to match the measured frequency or, in the 400 Hz case, a subharmonic of that frequency. This allows the HP 3457 to reject unwanted signals of power line frequency from measurements when you specify an integral number of power line cycles (1, 10, or 100) for the integration time. The reference frequency also affects the measurement speed.

The LFREQ command allows you to change the reference frequency. However, if you change the reference frequency so that it no longer corresponds to the line frequency, you lose AC line rejection. The LFREQ? query command reveals the A/D converter's reference frequency. The LINE? query command causes the HP 3457 to measure and return the actual power line frequency.

## Integration Time

This is the period of time that the A/D converter samples the input signal. This time is specified in number of power line cycles as a parameter of the NPLC command. The range is 0.0005 to 100 power line cycles. The NPLC? query command reveals the present integration time in number of power line cycles. Measurement resolution increases when you allow longer integration periods.

Multiply the power line period times the specified power line cycles to determine the integration time. For example, the period of a 50 Hz power line is  $1/50 = 20$  msec. With the power line cycles set to .1, the integration time is  $20 \text{ msec} \times .1 = 2$  msec. The .005 and .0005 PLCs, however, are fixed regardless of the line frequency at 100 usec. and 10 usec., respectively.

**Resolution** You can specify the measurement resolution as a parameter in most function commands (FUNC, ACV, DCV, etc.) and the RANGE command.

Resolution is determined by the integration time of the A/D converter. When you specify a certain resolution, you are indirectly specifying an integration time. Since the NPLC command also specifies an integration time, an interaction occurs between the two as follows:

- If you send the NPLC command before the function or RANGE command, the HP 3457 satisfies the command or parameter that designates the most PLCs (greatest resolution).
- If you send the NPLC command after the function or RANGE command, the HP 3457 uses the integration time specified by the NPLC command regardless of whether it specifies more or less resolution.

Typically, you should use the NPLC command to select the required amount of normal mode rejection, and the % resolution parameter to select the required resolution. This ensures you will have the required amount of normal mode rejection and at least the required resolution.

If you default (omit) the resolution parameter, the integration time is determined by the NPLC command.

Table 3-1 shows the relationship between the number of power line cycles (NPLC command), the resolution parameter (as a percentage of full scale), the maximum number of digits available, and the AC line rejection.

**Table 3-1. A/D Converter Relationships**

Power Line Cycles	Percentage of Full Scale	Maximum Number of Digits	AC line Rejection
.0005	.033%	3.5	0dB
.005	.0033%	4.5	0dB
.1	.00033%	5.5	0dB
1	.000033%	6.5	60dB
10	—	* 7.5	80dB
100	—	* 7.5	90dB

\* To obtain this resolution, you must consult the HIREMATH register and add its value to the reading. This addition can only be done externally from the HP 3457. Refer to "Extra Resolution," in this chapter, for more information.

**Range** You can specify the measurement range as a parameter of any function command (FUNC, DCV, ACV, etc.). You can also specify the range by using the RANGE command or its abbreviation, the R command. Additionally, you can have the HP 3457 automatically select the appropriate range by using the ARANGE command. The RANGE? query command reveals the present measurement range (even when using autorange).

**Autozero** With autozero on, following every measurement, the HP 3457 internally disconnects the input signal and takes a *zero reading*. It then subtracts the *zero reading* from the preceding measurement. This prevents offset voltages present on the HP 3457's input circuitry from affecting measurements.

With autozero off, the HP 3457 takes one *zero reading* and subtracts it from all subsequent measurements. It takes a new *zero reading* each time there is a function or range change. You turn autozero on and off with the AZERO command. The AZERO? query command reveals whether autozero is on or off.

**Voltmeter Complete** The rear panel voltmeter complete BNC terminal provides a low-going TTL pulse after the completion of each measurement. This is valid for all measurement functions (frequency, AC voltage, 2-wire ohms, etc.). You can use this to synchronize other equipment (e.g., a scanner) to the HP 3457.

## Predefined States

The HP 3457 has three predefined states; the power-on state, the reset state, and the preset state.

**Power-On State** When you apply power to the HP 3457, it sets many of its commands to predefined power-on values. This is evidenced by the fact that it automatically triggers and ranges, and makes DC voltage measurements. This is known as the power-on state.

**Reset and Preset States** The RESET and PRESET commands also configure the HP 3457 to predefined states. RESET is primarily for front panel use and configures the HP 3457 to a good starting point for local operation. PRESET is primarily for remote use and selects a good starting point for remote operation.

Table 3-2 shows the power-on state, the RESET state, and the PRESET state.

**Table 3-2. Power-on, Reset, and Preset States**

Item	State
ACBAND	20 (SLOW)
ARANGE	ON
AZERO	ON
BEEP	ON (RESET) Last Value (PRESET)
CHAN	None connected
DELAY	Default (minimum requirement for accuracy)
DISP	ON
EMASK	2047 (all enabled)
END	OFF
ERROR register	Results of self-test
FIXEDZ	OFF
FSOURCE	ACV
FUNC	DCV
HP-IB ADDRESS	Not changed (set 22 from factory)
INBUF	OFF
LOCK	OFF
MATH	OFF,OFF
Math registers set to 0, except:	
PERC	1
REF	1
RES	50
SCALE	1
DEGREE	20
MEM	OFF
MFORMAT	SREAL
MSIZE	Not changed
NDIG	5
NPLC	10 (Power-on and RESET) 1 (PRESET)
NRDGS	1,AUTO
OCOMP	OFF
OFORMAT	ASCII
PROGRAM MEMORY	Clear
RANGE	AUTO
READING MEMORY	Clear
RQS	Power-on bit unchanged, the rest cleared
SADV	HOLD
SLIST	Empty List
STATE STORAGE	For Power-on, 1 - 10 states intact (as allocated in MSIZE), state 0 contains previous power-down state. For RESET and PRESET, all states intact.
STATUS register	Power-on bit plus results of self-test (Power-on). Results of self-test (RESET and PRESET)
TARM	AUTO
TERM	FRONT panel
TIMER	1 sec.
TRIG	AUTO (Power-on and RESET) SYN (PRESET)

## Clearing the HP 3457

If the HP 3457 is busy with a measurement or some I/O operation, it will not respond to a remote RESET or PRESET command. To clear the HP 3457, execute the HP-IB Device Clear or Selected Device Clear command followed by RESET or PRESET. The HP BASIC command for Device Clear is CLEAR 7, for Selected Device Clear; CLEAR 722.

# Voltage Measurements

The HP 3457 is capable of making DC voltage, AC voltage, and AC+DC voltage measurements. Figure 3-2 shows the front and rear terminal connections for all types of voltage measurements.

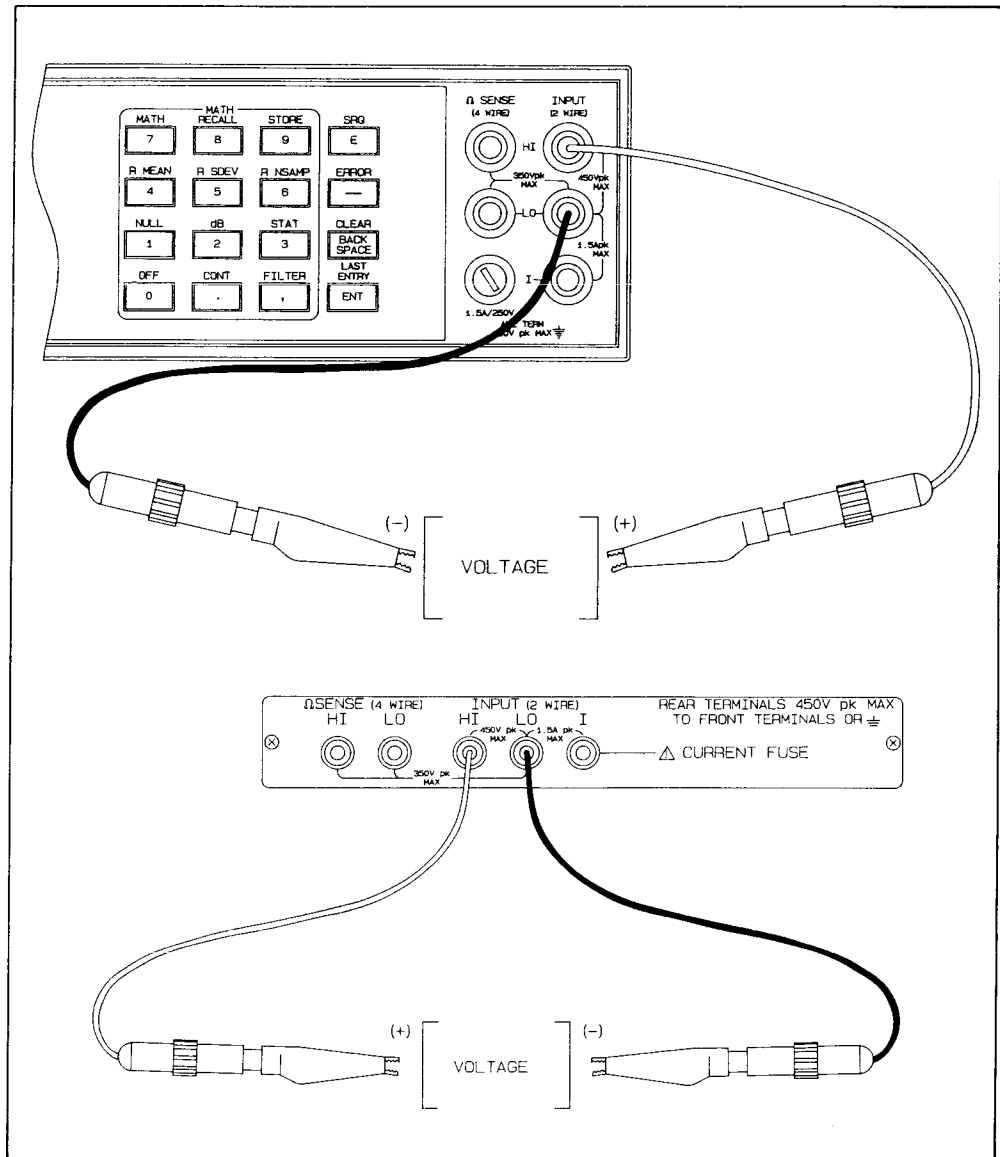


Figure 3-2. Voltage Measurement Connections

## DC Voltage Measurements

The HP 3457 can measure DC voltages ranging from 10 nanovolts to 300 volts. The input is protected for overloads up to 450 volts.

From remote, you select DC voltage measurements using the DCV command or the FUNC command (with DCV as the first parameter). You can also specify the measurement range and resolution with either of these commands. From remote, you can also use the F10 through F15 commands to select DC voltage measurements and the measurement range. These commands configure the HP 3457 much more rapidly than the DCV or FUNC command.

From the front panel, you select DC voltage measurements using the DCV key or by accessing the FUNC command from the alphabetic command directory. The DCV key does not allow you to select any additional parameters. With the FUNC command, you can specify the measurement range and resolution. Table 3-3 shows the ranges and the corresponding resolution.

**Table 3-3. DCV Range vs. Resolution**

Range	Resolution			
	6.5 Digits	5.5 Digits	4.5 Digits	3.5 Digits
30 mV	10 nV	100 nV	1 $\mu$ V	10 $\mu$ V
300 mV	100 nV	1 $\mu$ V	10 $\mu$ V	100 $\mu$ V
3 V	1 $\mu$ V	10 $\mu$ V	100 $\mu$ V	1 mV
30 V	10 $\mu$ V	100 $\mu$ V	1 mV	10 mV
300 V	100 $\mu$ V	1 mV	10 mV	100 mV

**Input Impedance** When making DC voltage measurements, you can fix the HP 3457's input impedance using the FIXEDZ command. This is useful to prevent a change in input impedance (caused by changing ranges) from affecting the measurement. Table 3-4 shows the input impedances with FIXEDZ on and off. The FIXEDZ? query command reveals whether FIXEDZ is on or off.

**Table 3-4. Input Impedances**

Function	Ranges	Input Impedance	
		FIXEDZ ON	FIXEDZ OFF
DCV	30 mV, 300 mV, 3 V	10 M $\Omega$	10 G $\Omega$
DCV	30 V, 300 V	10 M $\Omega$	10 M $\Omega$ OHM

## AC and AC + DC Voltage Measurements

The HP 3457 can measure AC or AC+DC voltages ranging from 10 nanovolts to 300 volts RMS in a bandwidth of 20 Hz to 1 MHz. The input is protected for overloads up to 318 volts RMS (450 volts peak) at the front and rear terminals.

From remote, you select AC voltage measurements using the ACV command or the FUNC command (with ACV as the first parameter). You select AC+DC voltage measurements using the ACDCV command or the FUNC command (with ACDCV as the first parameter). You can also specify the measurement range and resolution with any of these commands.

From the front panel, you select AC voltage measurements using the ACV key and AC+DC voltage measurements using the shifted ACDCV key. You can also select these measurements by accessing the FUNC command from the alphabetic command directory. The ACV and ACDCV keys do not allow you to select any additional parameters. With the FUNC command, you can specify the measurement range and resolution. Table 3-5 shows the ranges and the corresponding resolution.

**Table 3-5. AC or AC + DC Voltage Range vs. Resolution**

Range	Resolution			
	6.5 Digits	5.5 Digits	4.5 Digits	3.5 Digits
30 mV	10 nV	100 nV	1 $\mu$ V	10 $\mu$ V
300 mV	100 nV	1 $\mu$ V	10 $\mu$ V	100 $\mu$ V
3 V	1 $\mu$ V	10 $\mu$ V	100 $\mu$ V	1 mV
30 V	10 $\mu$ V	100 $\mu$ V	1 mV	10 mV
300 V	100 $\mu$ V	1 mV	10 mV	100 mV

---

### NOTE

*When taking measurements on the 30 mV and 300 mV ranges, it is possible for radiated noise (transients caused by reactive loads such as large motors turning on and off) to cause inaccurate readings. For accurate readings in these ranges, ensure that your nearby environment is electrically "quiet" and use shielded test leads.*

---



The HP 3457 uses a true RMS to DC converter for AC and AC + DC voltage measurements. It can measure the true RMS value of signals that are noisy, nonperiodic, or nonsinusoidal such as sawtooth, triangle, and square waveforms. It also measures the true RMS value of low repetition rate, high crest factor (ratio of peak to RMS) pulse trains. In addition, the RMS to DC converter can measure any of these waveforms riding on a DC voltage level and can either include the DC level in the RMS value (AC + DC voltage measurements) or block the DC component (AC voltage measurements).

When making AC or AC + DC voltage measurements, you can select the slow or fast mode. The slow mode is for signals below 400 Hz. In the slow mode, a longer time constant is used for the input filter and a longer delay is used (as compared to the fast mode). The fast mode is for signals greater than or equal to 400 Hz and uses a shorter time constant and delay. The fast mode allows you to make a series of measurements in a shorter amount of time. Table 3-15 (under "Delay" in this chapter) shows the various delay times used in the slow and fast modes. The ACBAND command selects the slow or fast mode.

# Resistance Measurements

The HP 3457 can measure resistances ranging from 10  $\mu\Omega$  to 3 G $\Omega$ . The input is protected for overloads up to 450 volts.

The HP 3457 measures resistance by sourcing a known current through the unknown resistance being measured. The current passing through the resistance generates a voltage across it. The HP 3457 measures this voltage and calculates the unknown resistance (resistance = voltage/current).

Table 3-6 shows the nominal currents sourced and the maximum resolution for each range.

**Table 3-6. Ohms Range vs. Resolution and Current Sourced**

Range	Resolution				Current Sourced
	6.5 Digits	5.5 Digits	4.5 Digits	3.5 Digits	
30 $\Omega$	10 $\mu\Omega$	100 $\mu\Omega$	1 m $\Omega$	10 m $\Omega$	1 mA
300 $\Omega$	100 $\mu\Omega$	1 m $\Omega$	10 m $\Omega$	100 m $\Omega$	1 mA
3 k $\Omega$	1 m $\Omega$	10 m $\Omega$	100 m $\Omega$	1 $\Omega$	1 mA
30 k $\Omega$	10 m $\Omega$	100 m $\Omega$	1 $\Omega$	10 $\Omega$	100 $\mu\text{A}$
300 k $\Omega$	100 m $\Omega$	1 $\Omega$	10 $\Omega$	100 $\Omega$	10 $\mu\text{A}$
3 M $\Omega$	1 $\Omega$	10 $\Omega$	100 $\Omega$	1 k $\Omega$	1 $\mu\text{A}$
30 M $\Omega$	10 $\Omega$	100 $\Omega$	1 k $\Omega$	10 k $\Omega$	100 nA
*300 M $\Omega$	100 $\Omega$	1 k $\Omega$	10 k $\Omega$	100 k $\Omega$	100 nA
*3 G $\Omega$	1 k $\Omega$	10 k $\Omega$	100 k $\Omega$	1 M $\Omega$	100 nA

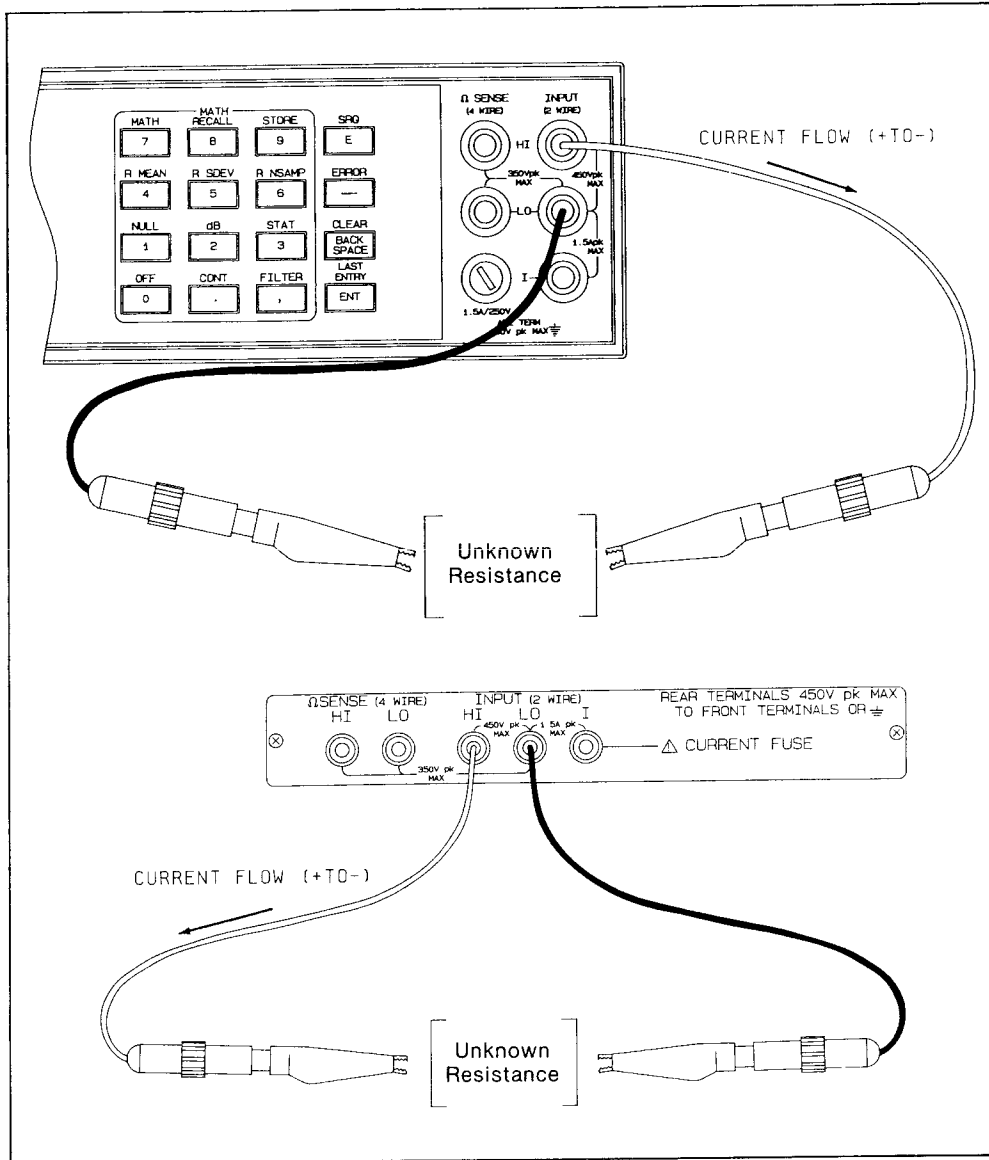
\* The "extended ohms range" is a combination of two ranges; the 300 M $\Omega$  and 3 G $\Omega$  range. When using the extended ohms range, the HP 3457 places its internal 10 G $\Omega$  resistor in parallel with the input terminals and sources 100 nA through the combination of this resistor and the unknown resistance being measured. Always perform the OHMS autocal before using the extended ohms range. Refer to "Calibration," in this chapter, for more information.

## 2-Wire Ohms

Figure 3-3 shows the connections for making 2-wire ohms measurements.

From remote, you select 2-wire ohms measurements using the OHM command or the FUNC command (with OHM as the first parameter). You can also specify the measurement range and resolution with either of these commands. From remote, you can also use the F40 through F48 commands to select 2-wire ohms measurements and the measurement range. These commands configure the HP 3457 much more rapidly than the OHM or FUNC command.

From the front panel, you select 2-wire ohms measurements using the OHM key or by accessing the FUNC command from the alphabetic command directory. The OHM key does not allow you to select any additional parameters. With the FUNC command, you can specify the measurement range and resolution.



**Figure 3-3. 2-Wire Ohms Measurement Connections**

2-wire ohms is most commonly used when the resistance of the test leads is much less than the value being measured. If the lead resistance is large compared to that of the desired measurement, your reading will be inaccurate. For example, suppose you are measuring a one ohm resistor located ten feet away. If you use 24 gauge copper wire to make the connections, the 20 feet of leads contribute about 0.5 ohms to the measurement. This makes the total measurement 1.5 ohms—an error of 50%.

Some other factors that may cause high lead resistance are loose or dirty connections, kinked or damaged wires, or leads in a very high heat environment.

You can enhance the accuracy of 2-wire ohms measurements by using the NULL math operation. To do this, connect the leads together, turn the math NULL operation on, and make one resistance measurement. The HP 3457 stores this first reading in the OFFSET register. The HP 3457 then subtracts the value in the OFFSET register from all subsequent measurements until the math NULL operation is turned off. This method is not as accurate as 4-wire ohms because the resistance of the test leads connected together probably will not be the same as when they are connected to the unknown resistance. Also, the resistance of the test leads is only checked once for a series of measurements and the test lead resistance may change.

## 4-Wire Ohms

Figure 3-4 shows the connections for making a 4-wire ohms measurement.

From remote, you select 4-wire ohms measurements using the OHMF command or the FUNC command (with OHMF as the first parameter). You can also specify the measurement range and resolution with either of these commands. From remote, you can also use the F50 through F58 commands to select 4-wire ohms measurements and the measurement range. These commands configure the HP 3457 much more rapidly than the OHMF or FUNC command.

From the front panel, you select 4-wire ohms measurements using the OHMF key (shifted OHM key) or by accessing the FUNC command from the alphabetic command directory. The OHMF key does not allow you to select any additional parameters. With the FUNC command, you can specify the measurement range and resolution.

The 4-wire ohms mode eliminates the measurement error caused by test lead resistance. In 2-wire ohms, the voltage measurement is made across the combined resistance of the test leads and the unknown resistance. In 4-wire ohms, the voltage is measured across the unknown resistance only, not the combined resistance. The 4-wire ohms mode is essential when the greatest degree of accuracy is required, especially when the test lead resistance is high in comparison to the resistance being measured.

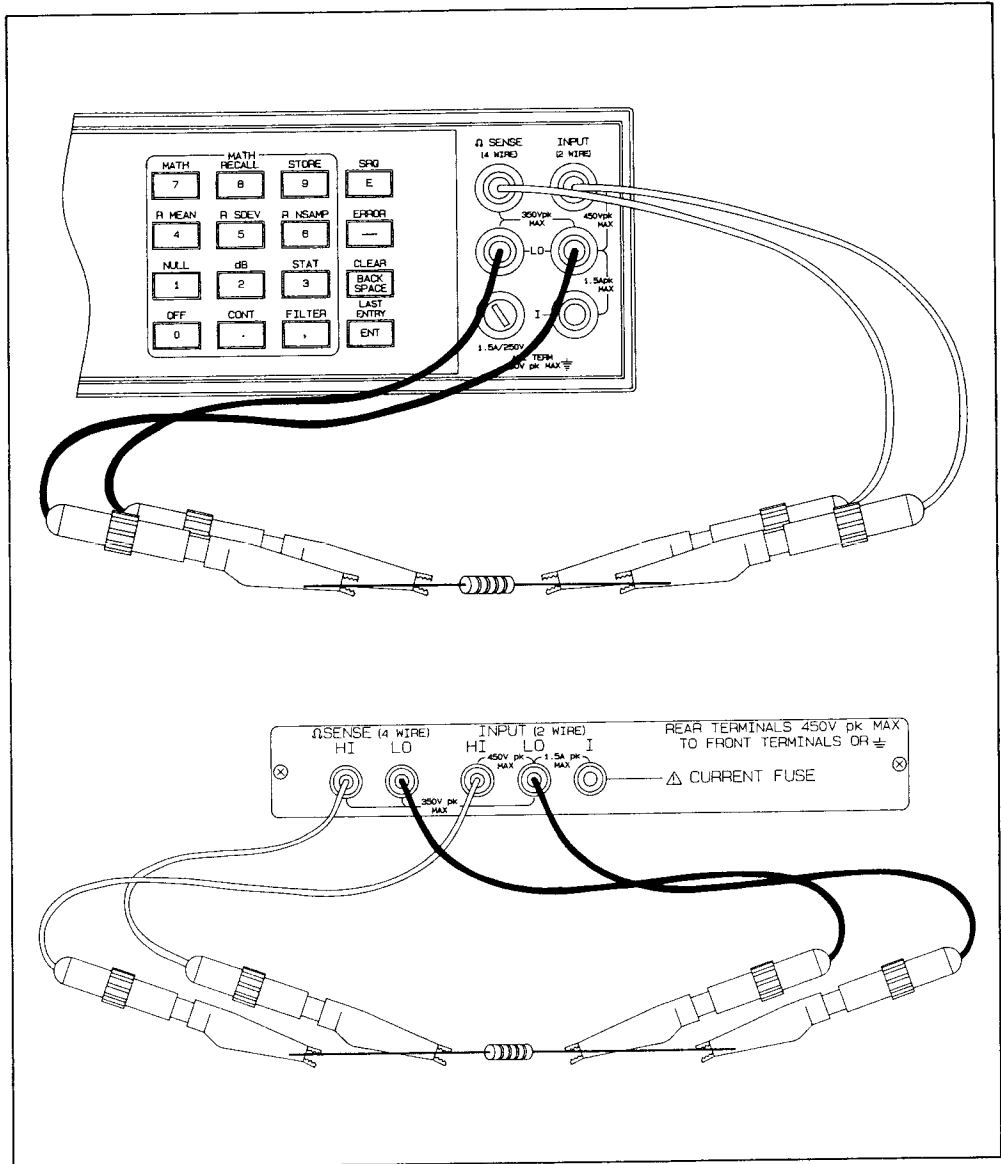


Figure 3-4. 4-Wire Ohms Measurement Connections

## Offset Compensation

With offset compensation on, the HP 3457 compensates for small extraneous voltages on the 30  $\Omega$  through 3 k $\Omega$  ranges. Offset compensation does not function on the higher ranges. The OCOMP command turns offset compensation on or off. The OCOMP? query command reveals whether offset compensation is on or off.

The HP 3457 compensates for offset by, first, measuring the offset voltage. Next, it sources current and measures the combination of induced voltage and offset voltage. The HP 3457 subtracts the offset voltage from the combined voltage leaving only the induced voltage. The HP 3457 then uses this induced voltage to determine the resistance; resistance = voltage/current. Table 3-7 shows the maximum offset voltage that can be present on offset compensated measurements for the various ranges. Also shown are the resulting combined voltages.

You can use offset compensation for both 2-wire and 4-wire ohms measurements.

**Table 3-7. Maximum Offset Voltages**

Range	Maximum Offset for Full Scale Measurements	Resulting Combined Voltage
30 $\Omega$	.001 V	.0303 V
300 $\Omega$	.01 V	.303 V
3 k $\Omega$	.1 V	3.03 V

For example, you can use offset compensation when making 4-wire ohms measurements on an RTD temperature sensor. In this case, there may be small thermal voltages present at the connections due to the thermocouple effect at the junction of two dissimilar metals. These small voltages could cause large errors when trying to detect changes as small as 0.1 m $\Omega$ .

# Current Measurements

The HP 3457 measures current by, first, placing an internal shunt resistor across the input terminals (see Tables 3-8 and 3-9 for shunt resistance values). Next, the HP 3457 measures the voltage induced across the shunt resistor. The HP 3457 then calculates the current flowing through the shunt resistor using the equation;  $\text{current} = \text{voltage}/\text{resistance}$ .

Figure 3-5 shows the front and rear terminal connections for measuring DC, AC, or AC + DC current.

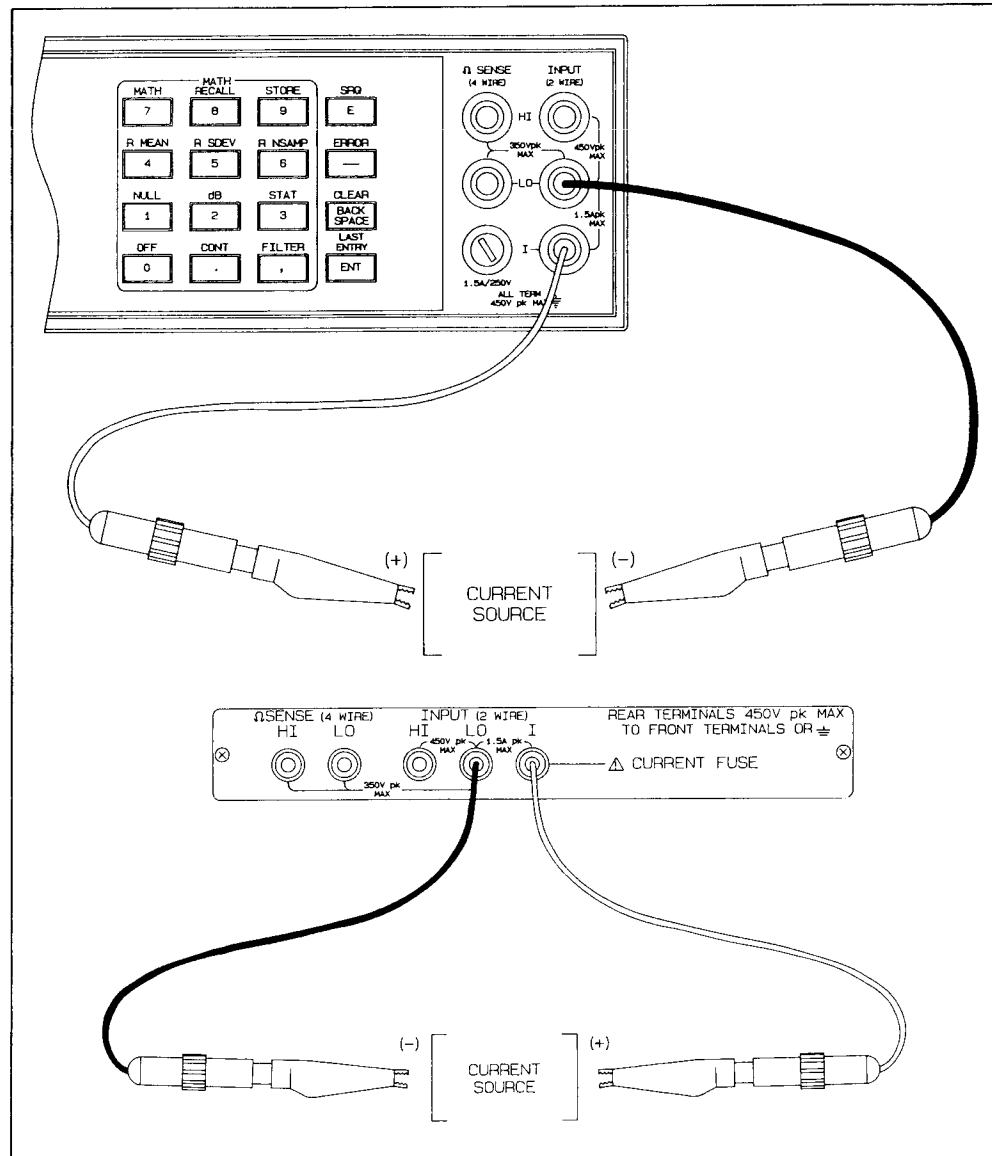


Figure 3-5. Current Measurement Connections

The HP 3457's front and rear current inputs are protected by 1.5 amp, 250 volt fuses. Refer to Chapter 1 for information on replacing one of the HP 3457's current fuses. The current input channels on the HP 44491 optional plug-in card also contain 1.5 amp 250 volt fuses. Refer to Chapter 5 for information on replacing a fuse on the HP 44491.

## DC Current Measurements

The HP 3457 can make DC current measurements ranging from 100 picoamps to 1.5 amps.

From remote, you select DC current measurements using the DCI command or the FUNC command (with DCI as the first parameter). You can also specify the measurement range and resolution with either of these commands.

From the front panel, you select DC current measurements using the DCI key or by accessing the FUNC command from the alphabetic command directory. The DCI key does not allow you to select any additional parameters. With the FUNC command, you can specify the measurement range and resolution. Table 3-8 shows the ranges and the corresponding resolution.

**Table 3-8. DCI Range vs. Resolution**

DCI Range	Resolution				Shunt Resistor
	6.5 Digits	5.5 Digits	4.5 Digits	3.5 Digits	
300 $\mu$ A	100 pA	1 nA	10 nA	100 nA	1000 $\Omega$
3 mA	1 nA	10 nA	100 nA	1 $\mu$ A	100 $\Omega$
30 mA	10 nA	100 nA	1 $\mu$ A	10 $\mu$ A	10 $\Omega$
300 mA	100 nA	1 $\mu$ A	10 $\mu$ A	100 $\mu$ A	1 $\Omega$
1.5 A	1 $\mu$ A	10 $\mu$ A	100 $\mu$ A	1 mA	.1 $\Omega$

## AC and AC + DC Current Measurements

The HP 3457 can make AC and AC + DC current measurements ranging from 10 nanoamps to 1 amp RMS. The frequency range for AC or AC + DC current is 20 Hz to 100 kHz.

From remote, you select AC current measurements using the ACI command or the FUNC command (with ACI as the first parameter). You select AC + DC current measurements using the ACDCI command or the FUNC command (with ACDCI as the first parameter). You can also specify the measurement range and resolution with any of these commands.

From the front panel, you select AC current measurements using the ACI key and AC + DC current measurements using the shifted ACDCI key. You can also select these measurements by accessing the FUNC command from the alphabetic command directory. The ACI and ACDCI keys do not allow you to select any additional parameters. With the FUNC command, you can specify the measurement range and resolution. Table 3-9 shows the ranges and the corresponding resolution.



**Table 3-9. ACI and AC + DCI Range vs. Resolution**

ACI Range	Resolution				Shunt Resistor
	6.5 Digits	5.5 Digits	4.5 Digits	3.5 Digits	
30 mA	10 nA	100 nA	1 $\mu$ A	10 $\mu$ A	10 $\Omega$
300 mA	100 nA	1 $\mu$ A	10 $\mu$ A	100 $\mu$ A	1 $\Omega$
1 A	1 $\mu$ A	10 $\mu$ A	100 $\mu$ A	1 mA	.1 $\Omega$

The HP 3457 uses a true RMS to DC converter for AC and AC+DC current measurements. It can measure the true RMS value of signals that are noisy, nonperiodic, or nonsinusoidal such as sawtooth, triangle, and square waveforms. It also measures the true RMS value of low repetition rate, high crest factor (ratio of peak to RMS) pulse trains. In addition, the RMS to DC converter can measure any of these waveforms riding on a DC level and can either include the DC level in the RMS value (AC+DC current measurements) or block the DC component (AC current measurements).

When making AC or AC+DC current measurements, you can select the slow or fast mode. The slow mode is for signals below 400 Hz. In slow mode, a longer time constant is used for the input filter and a longer delay is used (as compared to the fast mode). The fast mode is for signals greater than or equal to 400 Hz and uses a shorter delay time. The fast mode allows you to make a series of measurements in a shorter amount of time. Table 3-15 (under "Delay" in this chapter) shows the various delay times used in both the slow and fast modes. The ACBAND command selects the slow or fast mode.

# Frequency and Period Measurements

The HP 3457's frequency and period counter accepts AC volts, AC + DC volts, AC current, or AC + DC current as inputs. Use the FSOURCE command to specify the type of input signal. Figure 3-6 shows the front and rear terminal connections for frequency and period measurements.

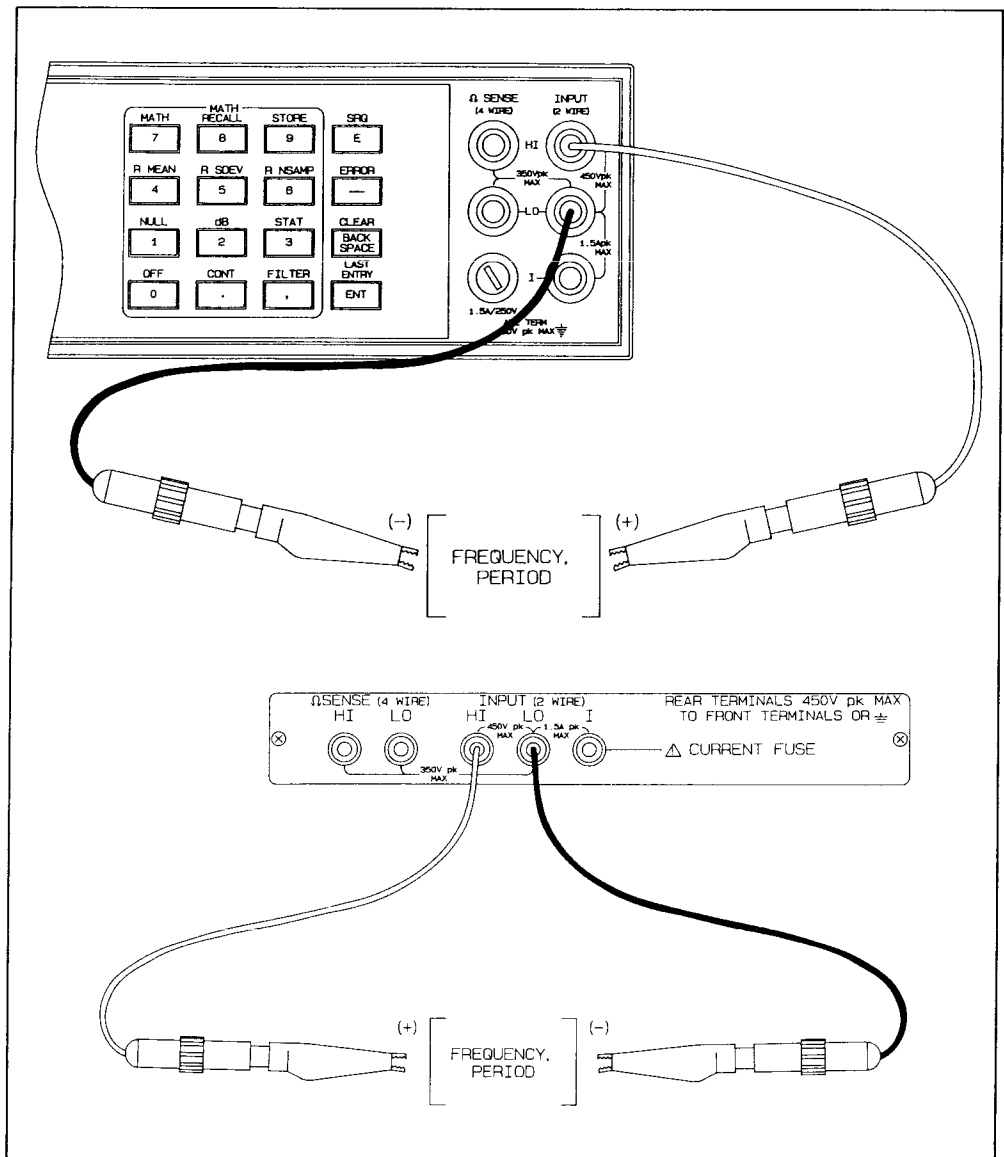


Figure 3-6. Frequency and Period Measurement Connections

When using a voltage input, the HP 3457 can make frequency measurements from 10 Hz to 1.5 MHz, or period measurements from 100 msec to 667 nsec. When using a current input, the HP 3457 can make frequency measurements from 10 Hz to 100 kHz or period measurements from 100 msec to 3.33  $\mu$ sec.

Frequency and period are the only functions that have constant resolution; always 7 digits.

From remote, you select frequency measurements using the `FREQ` command and period measurements using the `PER` command. You can also use the `FUNC` command (with `FREQ` or `PER` as the first parameter). With any of these commands, you can select the range by specifying the expected maximum amplitude (voltage or current) of the input signal. If you omit this range parameter, the HP 3457 defaults to autorange.

From the front panel, you select frequency measurements using the `FREQ` key and period measurements using the `PER` key (shifted `FREQ` key). You can also select these measurements by accessing the `FUNC` command from the alphabetic command directory. The `FREQ` and `PER` keys do not allow you to select any additional parameters. With the `FUNC` command, you can select the range by specifying the maximum expected amplitude (voltage or current) of the input signal. If you omit this range parameter, the HP 3457 defaults to autorange.

When making any frequency or period measurements, you can select the slow or fast mode. The slow mode is for signals below 400 Hz. In slow mode, a longer time constant is used for the input filter and a longer delay is used (as compared to the fast mode). The fast mode is for signals greater than or equal to 400 Hz and uses a shorter delay time. The fast mode allows you to make a series of measurements in a shorter amount of time. Table 3-15 (under "Delay" in this chapter) shows the various delay times used in the slow and fast modes. The `ACBAND` command selects the slow or fast mode.

# Math Operations

The HP 3457's math operations manipulate or modify a measured reading before it is displayed, stored, or placed in the output buffer. In addition, there are two math operations (STAT and PFAIL) that do not directly alter the reading, but store information pertaining to it.

The selected math operation is performed on every reading. As long as you leave a math operation on, it remains in effect even if you change the range or measurement function (DCV, OHM, etc.).

Two math operations can be enabled at the same time. The value of a measurement is first passed through the operation listed as the first parameter of the MATH command. That result is then passed through the operation listed as the second parameter. If you omit the second parameter, only one operation is enabled. When you select a different math operation(s), any previous math operations are canceled. The MATH? query command reveals the math operations that are presently enabled.

Most of the math operations involve the use of one or more internal registers. Some of these registers must be preset by you, and others hold the results of an operation. You preset a register using the SMATH command. You read the contents of a register using the RMATH command.

## Turning Math Off and On

To enable a math operation, send the MATH command followed by the operation. For example, to enable the NULL operation send; MATH NULL. To enable two operations, just place the second operation after the first. For example, to enable the NULL and PERC operations, send; MATH NULL,PERC. To turn off any enabled math operation(s), use the MATH OFF command. You can use MATH CONT to re-enable the operation that was suspended by the OFF operation. If you had two operations in effect, issue MATH CONT,CONT to re-enable both.

**NULL** The NULL operation subtracts a value from each subsequent measurement. The equation is:

$$\text{Result} = \text{Reading} - \text{OFFSET}$$

Where:

**Reading** is any measurement made after the first.

**OFFSET** is the value stored in the OFFSET register (typically the first reading).

After you select the NULL operation, the first measured reading is stored in the OFFSET register. This value is then subtracted from all subsequent readings. If you do not want the first measurement to be the null value, you can write another value to the OFFSET register using the SMATH command. You must wait, however, until the first reading is stored before changing the value.

A possible application of the NULL operation is in making more accurate 2-wire ohms measurements. To do this, select 2-wire ohms (OHM command) and short the ends of the test leads together. Now enable the NULL operation. The first reading taken (the lead resistance) is stored in the OFFSET register. Connect the test leads to the unknown resistance to be measured. The HP 3457 subtracts the test lead resistance from each resistance measurement, thus eliminating the effects of the test lead resistance.

**SCALE** The SCALE operation modifies readings by subtracting an offset and dividing by a scale factor. The equation is:

$$\text{Result} = (\text{Reading} - \text{OFFSET})/\text{SCALE}$$

Where:

**Reading** is any measured value.

**OFFSET** is the value stored in the OFFSET register (default = 0).

**SCALE** is the value stored in the SCALE register (default = 1).

Notice that the default values do not change the reading (they subtract 0 and divide by 1). You can change the values in the OFFSET register or the SCALE register using the SMATH command.

If you want to perform an addition or subtraction only, leave a 1 in the SCALE register. To add an offset to a reading, enter a negative number in the OFFSET register. To subtract an offset from a reading, enter a positive number into the OFFSET register. The equation now becomes:

$$\text{Result} = (\text{Reading} - \text{OFFSET})/1 = \text{Reading} - \text{OFFSET}$$

If you want to perform a division only, enter a 0 into the OFFSET register and enter the divisor into the SCALE register. The equation now becomes:

$$\text{Result} = (\text{Reading} - 0)/\text{SCALE} = \text{Reading}/\text{SCALE}$$

If you want to perform a multiplication only, enter a 0 into the OFFSET register and enter the reciprocal of the multiplier (1/multiplier) into the SCALE register. The equation now becomes:

$$\text{Result} = \frac{\text{Reading} - 0}{1/\text{SCALE}}$$

For example, suppose you want to multiply by 2. The reciprocal of 2 is  $1/2 = .5$ . Enter the value .5 into the SCALE register.

## Percent

The PERC math operation determines the difference, in percent, between a measured reading and the value in the PERCENT register. The equation is:

$$\text{Result} = ((\text{Reading} - \text{PERC})/\text{PERC}) \times 100$$

Where:

**Reading** is any measured value.

**PERC** is the value stored in the PERCENT register (power-on value = 1).

You can change the value in the PERCENT register using the SMATH command.

You can use the PERC math operation to determine the difference (in percent) between an ideal value and the measured value. For example, you may want to know the percent error of a 10 VDC voltage measurement. To do this, enable the PERC math operation and enter the ideal value (10) into the PERC register. Now measure the DC voltage. If the measurement is exactly 10 VDC, the HP 3457 displays a 0. If the measurement is, for example, 10.1 VDC, the result becomes:

$$\text{Result} = ((10.1 - 10)/10) \times 100 = .01 \times 100 = 1$$

The HP 3457's display shows 1 indicating the measured value is 1% higher than the ideal value.

**DB** The DB math operation calculates a ratio in decibels. The equation is:

$$\text{Result} = 20 \times \log_{10} (\text{Reading}/\text{REF})$$

Where:

**Reading** is any measured value.

**REF** is the value in the REF register (default = 1).

You can change the value in the REF register using the SMATH command. However, the value in the REF register is checked only once—when you enable DB. For this reason, place a value in the REF register *before* enabling DB.

A typical application for the DB operation is in determining an amplifier's voltage gain. First, measure the input voltage to the amplifier and store that value into the REF register (use the SMATH command). Next, enable the DB math operation (MATH DB command). Now measure the amplifier's output voltage. The gain of the amplifier is now calculated and displayed in dB. For example, if the input voltage is .1 V and the output voltage is 10 V, the gain is:

$$20 \times \log_{10} (10/.1) = 20 \times \log_{10} 100 = 40\text{dB}$$

**DBM** The DBM math operation calculates the power delivered to a resistance referenced to 1 mW. The equation is:

$$\text{Result} = 10 \times \log_{10} (\text{Reading}^2 / \text{RES}/1 \text{ mW})$$

Where:

**Reading** is any measured value.

**RES** is the resistance value in the RES register (default = 50  $\Omega$ )

You can change the value in the RES register using the SMATH command. However, the value in the RES register is checked only once—when you enable DBM. For this reason, place a value in the RES register *before* enabling DBM.

A typical application for the DBM operation is determining the input power to a loudspeaker. First, enter the speaker's impedance into the RES register (for this example, assume 8  $\Omega$ ). Now enable the DBM operation and measure the input voltage to the speaker. The HP 3457 calculates and displays the input power. For example, if the input voltage is 10 V, the power is:

$$10 \times \log_{10} (10^2 / 8/1\text{mW}) = 40.97\text{dBm}$$

**FILTER** The filter math operation simulates the output of a single pole, low pass, RC filter. This allows you to reduce the effects of random noise while preserving long-term trends.

The equation is:

$$\mathbf{Result = (Previous\ Result) \cdot (DEGREE-1) / DEGREE + Reading / DEGREE}$$

Where:

**Previous Result** is initially set to the value of the first reading and thereafter is set to the result of this FILTER operation.

**Reading** is any measured reading.

**DEGREE** selects the step response of the filter.

The value of DEGREE corresponds to the step response of the low-pass filter. That is, if the value of DEGREE is 20, 20 readings are required for the step response to achieve 63% of its final value. You can achieve slower response or quieter readings by increasing the value of DEGREE.

The actual time constant (R•C) of the filter can be determined by:

$$t = \frac{1}{f_s} \left\{ \frac{1}{\ln \left( \frac{\mathbf{DEGREE}}{\mathbf{DEGREE-1}} \right)} - 1 \right\}$$

Where:

**t** = the time constant (R•C)

**f<sub>s</sub>** = the sampling rate (refer to RMS, in this chapter, for a procedure on determining the sampling rate).

If DEGREE is larger than 10, (R•C) can be approximated by:

$$t \approx (1/f_s) \cdot \mathbf{DEGREE}$$

For example (using the first equation), if the reading rate is 15 Hz and the DEGREE is 20, the time constant is:

$$t = \frac{1}{15} \left\{ \frac{1}{\ln \left( \frac{20}{20-1} \right)} - 1 \right\} = 1.23 \text{ seconds}$$

Using the second equation with the same reading rate and DEGREE produces:

$$t \approx (1/15) \cdot 20 = 1.33 \text{ seconds}$$



**RMS** The RMS math operation allows you to measure slow sinewaves of less than 20 Hz and displays the combined RMS value of the AC and DC components. For AC signals greater than 20 Hz, the AC voltage, AC+DC voltage, AC current, or AC+DC current measurement functions can be used instead of the RMS math operation.

---

**NOTE**

*Alternatively, you can determine the RMS value of the AC component of slow sinewaves by selecting DC voltage measurements and enabling the STATS math operation. After a number of readings, the result in the SDEV register is the RMS value of the AC component of the input signal.*

---

The RMS math equation is:

**Result = square root of the above FILTER operation with the input (reading) to FILTER first squared**

The following is a procedure for using the RMS operation to determine the RMS value of a slow AC (<15 Hz) sinewave:

1. Set the HP 3457 to measure DC voltage or DC current and select a range that will accommodate the peak value of the AC signal (do not use autorange). Set autozero to OFF (AZERO command) and specify .1 power line cycles (NPLC command). Enable the RMS math operation (MATH command). For example, the following program sets-up the HP 3457 to measure an input signal of less than 30V peak and selects 0.1 power line cycle:

```
10 OUTPUT 722;"RESET"           !Resets the HP 3457
20 OUTPUT 722;"FUNC DCV,30"     !Selects DC volts, 30V range
30 OUTPUT 722;"AZERO OFF"       !Disables autozero
40 OUTPUT 722;"NPLC .1"         !Selects 0.1 power line cycle
50 OUTPUT 722;"MATH RMS"        !Enables RMS math operation
60 END
```

2. Determine the HP 3457's sampling rate in readings per second ( $f_s$ ) either by connecting an electronic frequency counter to the HP 3457's rear panel Voltmeter Complete BNC connector or by using a computer to time a series of readings. As an example of the latter, the following program (1) suspends triggering, (2) sets the HP 3457 to make 100 readings, and (3) sends a single trigger. The computer uses its internal timer to time the execution of the single trigger. Then, by dividing into 100 (100 readings were taken) the program computes readings per second ( $f_s$ ). This particular program works on an HP series 200 computer. Refer to your computer operating manual for information on how to time events.

10 OUTPUT 722;"INBUF OFF"	!Disable input buffer
20 OUTPUT 722;"TRIG HOLD"	!Suspend triggering
30 OUTPUT 722;"NRDGS 100"	! Make 100 readings per trigger
40 T0=TIMEDATE	!Sets first time mark
50 OUTPUT 722;"TRIG SGL"	!Triggers the HP 3457
60 T1=TIMEDATE	!Sets second time mark
70 PRINT 100/(T1-T0)	!Determines $f_s$
80 END	

---

### NOTE

*For accurate results, the value of  $f_s$  must be at least twice the frequency of the input signal. You can increase the value of  $f_s$  by decreasing the number of power line cycles (NPLC command), turning off the display (DISP OFF command) and locking out the keyboard (LOCK ON command).*

---

3. Use the following equation to determine the time constant of the RC digital filter used in the RMS operation:

$$t > 1/(4\pi f_a e)$$

Where:

$t$  = time constant of the RC filter

$f_a$  = frequency of the input signal ( $f$ ) or  $(f_s/2) - f$  (whichever is less)

$e$  = % error allowable in the conversion (equivalent to ripple)

For example, assuming an input signal of 1 Hz, a sample rate ( $f_s$ ) of 30 Hz, and an allowable error ( $e$ ) of 1%:

$$t > 1/(4\pi 1 \bullet .01) = 8 \text{ seconds}$$

4. Determine the DEGREE constant for the RMS filter using:

$$D > \frac{1}{1 - 2.718 \left( \frac{-1}{f_s \bullet t + 1} \right)}$$

Where:

$D$  = DEGREE constant

$f_s$  = sampling rate

$t$  = time constant

Continuing the example:

$$D > \frac{1}{1 - 2.718 \left( \frac{-1}{30 \cdot 8 + 1} \right)} = 242$$

5. Calculate the settling time required:

$$\text{time} = t \ln(1/e)$$

Where:

**time** = settling time

**t** = time constant

**ln** = natural log

**e** = % error allowable in conversion

For example:

$$\text{time} = 8 \ln(1/.01) = 36.8 \text{ seconds}$$

6. Determine the number of readings required:

$$N = f_s \cdot \text{time}$$

Where:

**N** = number of readings

**time** = settling time

**f<sub>s</sub>** = sampling rate

For example:

$$N = 30 \cdot 36.8 = 1104$$

7. Specify the DEGREE (from step 4) using the SMATH command.  
Specify the number of readings (from step 6) using the NRDGS command.  
For example, the following program sets the DEGREE, the number of readings, and triggers the measurement:

```
10 OUTPUT 722;"SMATH 1,242"      !Sets the DEGREE
20 OUTPUT 722;"NRDGS 1104"      !1104 readings per trigger
30 OUTPUT 722;"TRIG SGL"        !Triggers once
40 END
```

## Temperature Measurements

The CTHRM (Celsius thermistor) math operation converts the measured resistance of a thermistor into degrees Celsius. The conversion is designed to work with a thermistor exhibiting a 5 k $\Omega$  resistance at 25° C, such as a type 44007 (HP part number 0837-0164) or equivalent. The resistance measurement can be made using either 2-wire or 4-wire ohms. Conditions that affect the accuracy of a typical resistance measurement will also affect the accuracy of the temperature measurement (see “Resistance Measurements,” this chapter). For the greatest accuracy, use the 4-wire ohms mode. Changing ranges can also affect the accuracy of the thermistor measurement. Use the 30 k $\Omega$  resistance range for thermistor measurements. This prevents thermistor self-heating caused by excessive currents on the lower resistance ranges.

The FTHRM (Fahrenheit thermistor) math operation is identical to the Celsius thermistor mode except that the measured resistance of the thermistor is converted into degrees Fahrenheit.

**Statistics** The STAT math operation performs five running calculations on the present series of measurements and stores the results. The calculations are: standard deviation, mean, number of samples, upper reading (largest magnitude), and lower reading (lowest magnitude). Table 3-10 shows the STAT registers and their contents. You read a STAT register using the RMATH command.

**Table 3-10. STAT Registers**

Register	Stored Result
SDEV	Standard deviation
MEAN	Average of the readings
NSAMP	Number of readings in this group of measurements
UPPER	Largest reading in this group of measurements
LOWER	Smallest reading in this group of measurements

**Pass/Fail** The PFAIL math operation tests each reading against the limits set in the MAX and MIN registers. If a limit is exceeded, the HP 3457 displays FAILED HI or FAILED LO and sets the high/low bit in the status register. The reading is not displayed as long as a limit is exceeded. The default value is 0 for both the MAX and MIN registers. You can change the value in either register using the SMATH command.

A typical application for the PASS/FAIL operation is verifying that a batch of 1 k $\Omega$  resistors are within 1% tolerance. To do this, store the upper and lower tolerance limits into the appropriate registers. In this case, store “1010” into the MAX register and “990” into the MIN register. Now select the 4-wire ohms function and the 3 k $\Omega$  range. Now enable the hi/low bit in the status register (use the RQS 2 command). With this bit enabled, the HP 3457 signals SRQ whenever the high or low limit is exceeded. At this point, you can either set up your computer to respond to the SRQ or watch the HP 3457’s display for the SRQ annunciator. You can now measure the resistors one by one. Whenever SRQ is signaled, a resistor is out of tolerance. To clear the SRQ situation, execute the CSB command.

**Extra Resolution** For each measurement you make with the number of power line cycles (NPLC) set to 10 or 100, an extra digit of resolution is placed in the HIRES register. This is true for all measurement functions except extended ohms, frequency, and period. You can recall the contents of the HIRES register (using the RMATH command) following each measurement. Then you add the contents of the HIRES register (externally from the HP 3457) to the measured reading. The resulting sum has 7.5 digits of resolution.

# Buffers

The HP 3457 contains two HP-IB buffers; an input buffer and an output buffer.

## The Input Buffer

With the input buffer on (INBUF ON command), the HP 3457 temporarily stores commands and immediately releases the bus. The HP 3457 then retrieves and executes the commands, one by one, from the input buffer. This allows the controller to do other operations while the HP 3457 is executing commands.

The input buffer is a 255 byte buffer that holds approximately 30 commands. If you send more commands than the input buffer can hold, the HP 3457 holds the bus until space becomes available. When space is available, the remaining commands are put into the input buffer and the bus is released.

When using the input buffer, it may be necessary to know when all buffered commands have been executed. The HP 3457 provides this information by setting a ready bit in the status register. If the status register is properly enabled, it drives the HP-IB's SRQ (service request) line true. Your controller will acknowledge this if previously programmed to accept SRQ as an interrupt. Refer to "The Status Register," in this chapter, for information on enabling the status register. Refer to "Triggering," in this chapter, for a detailed example on using the input buffer with the triggering commands and the status register.

With its input buffer off (INBUF OFF command), the HP 3457 processes each HP-IB command individually. This means it waits until the command is executed before releasing the HP-IB bus or accepting another command. In most cases, the computer must wait until the bus is released before it can continue. This is most noticeable on commands that take a long time to execute. For example, if you run all of the autocal routines from remote (ACAL ALL), the HP 3457 does not release the HP-IB bus until the autocal is complete – approximately 35 seconds. This is also particularly noticeable when requesting multiple readings using the TARM SGL or TRIG SGL command (refer to "Triggering," in this chapter, for more information).

If you are using the same command string repetitively, use the subprogram storage capability described in this chapter under "Memories."

## The Output Buffer

The HP 3457's output buffer provides temporary storage for one reading or the response to a query command. The contents of the buffer are replaced with every new reading or query response unless the present contents are partially read. In this case, the latest reading is saved until the previous reading is removed, then the latest reading is placed in the output buffer. This buffer is cleared whenever the HP 3457 receives a command.

The OFORMAT command allows you to select the format of output readings. The formats are; ASCII, SINT, DINT, and SREAL. In the following descriptions, the number of bytes listed for each format indicates the requirement for one measurement. Only the ASCII format sends <CR> <LF> (carriage return, line feed) on the data bus after the transmission of the data. This indicates the end of the transmission to most controllers. With any format, however, you can enable the HP-IB EOI (End Or Identify) function (END command) which sets the HP-IB EOI line true concurrent with the transmission of the last data byte.

**ASCII** The ASCII format is 16 bytes per reading and is represented as:

**SD.DDDDDDESDD <CR> <LF>**

Where:

**S** = +/-

**D** = 0-9

**E** = base 10 exponent

This is the most commonly used format. You can use this format whenever measurement speed is not critical. The advantages are that it has no scale factor and requires no special handling routine at your controller to "decode" the data. ASCII data is output in exponential notation.

**Single Integer** The single integer (SINT) format is 2 bytes per reading in two's complement coding (refer to "Two's Complement Binary Coding" at the end of this section for more information). You should use this format when making high speed, low accuracy measurements (3.5 or 4.5 digit resolution).

When using the SINT format, the HP 3457 applies a scale factor (some power of ten) to each reading to make it conform to integer format. To retrieve the scale factor, first retrieve the reading from the output buffer, then execute the ISCALE? query command.

ISCALE? places the scale factor in the output buffer using the ASCII format. After you retrieve the scale factor, the output buffer returns to SINT format. Note that if you execute ISCALE? first, the reading is replaced by the query's result and the displaced reading is lost. Table 3-11 shows the SINT scale factors for all the combinations of range and resolution (see Table 3-1 for the relationship of resolution and the A/D converter's configuration).

**Table 3-11. SINT Scale Factors**

Range	Digits Resolution			
	3.5	4.5	5.5	6.5
.0003	1E-7	1E-8	1E-8	1E-8
.003	1E-6	1E-7	1E-7	1E-7
.03	1E-5	1E-6	1E-6	1E-6
.3	1E-4	1E-5	1E-5	1E-5
3	.001	1E-4	1E-4	1E-4
30	.01	.001	.001	.001
300	.1	.01	.01	.01
3k	1	.1	.1	.1
30k	10	1	1	1
300k	100	10	10	10
3M	1E+3	100	100	100
30M	1E+4	1E+3	1E+3	1E+3
3G	1E+5	1E+5	1E+5	1E+5

**NOTE**

*All math operations except PFAIL and STAT have a SINT scale factor of 1 for all ranges and resolutions. Math operations PFAIL and STAT do not change the scale factor from the above table. The frequency and period measurement functions have a SINT scale factor of 100 for all ranges.*

**Double Integer** The double integer (DINT) format is 4 bytes per reading in two's complement coding (refer to "Two's Complement Binary Coding" at the end of this section for more information). You should use this format when making high speed, high accuracy measurements (5.5 digit resolution or greater).



When using the DINT format, the HP 3457 applies a scale factor (some power of ten) to each reading to make it conform to integer format. To retrieve the scale factor, first retrieve the reading from the output buffer then execute the ISCALE? query command. ISCALE? places the scale factor in the output buffer using the ASCII format. After you retrieve the scale factor, the output buffer returns to the DINT format. Note that if you execute ISCALE? first, the reading is replaced by the query's result and the displaced reading is lost. Table 3-12 shows the DINT scale factors for all the combinations of range and resolution (see Table 3-1 for the relationship of resolution and the A/D converter's configuration).

**Table 3-12. DINT Scale Factors**

Range	Digits Resolution			
	3.5	4.5	5.5	6.5
.0003	1E-7	1E-8	1E-9	1E-10
.003	1E-6	1E-7	1E-8	1E-9
.03	1E-5	1E-6	1E-7	1E-8
.3	1E-4	1E-5	1E-6	1E-7
3	.001	1E-4	1E-5	1E-6
30	.01	.001	1E-4	1E-5
300	.1	.01	.001	1E-4
3k	1	.1	.01	.001
30k	10	1	.1	.01
300k	100	10	1	.1
3M	1E+3	100	10	1
30M	1E+4	1E+3	100	10
3G	10	10	10	10

**NOTE**

*All math operations except PFAIL and STAT have a DINT scale factor of 1 for all ranges and resolutions. Math operations PFAIL and STAT do not change the scale factor from the above table. The frequency and period measurement functions have a DINT scale factor of 1 for all ranges.*

**Single Real** The single precision real (SREAL) format conforms to IEEE 754 specifications. This is 32 bits, 4 bytes per reading and is represented by:

**S EEE EEEE    E MMM MMMM    MMMM MMMM    MMMM MMMM**  
**byte 0                    byte 1                    byte 2                    byte 3**

Where:

**S** = sign bit (1 = negative 0 = positive)

**E** = base two's exponent biased by 127 (to "decode" these 8 bits, subtract 127 from their integer equivalent).

**M** = mantissa bits (those right of the radix point). There is an "implied digit" to the left of the radix point. This digit is always assumed to be "1". This provides an effective precision of 24 bits with the least significant bit (right most) weighted  $2^{-23}$ . Another way to evaluate this mantissa is to convert these 24 bits (most significant bit assumed "1") to an integer and then multiply by  $2^{-23}$ .

The value of a number in the SREAL format is calculated by:

$$(-1)^S \times (\text{mantissa}) \times 2^E$$

Since there is no scale factor, the SREAL format should be used when making measurements at the fastest possible rate with autorange on.

**EXAMPLE:**

Find the decimal equivalent of the following SREAL formatted number:

<b>SEEEEEEE</b>	<b>EMMMMMMM</b>	<b>MMMMMMMM</b>	<b>MMMMMMMM</b>
<b>10111011</b>	<b>11001000</b>	<b>1001000</b>	<b>10010000</b>

The sign bit "S" is set "1," this indicates that the number is negative.

The base two's exponent (**01110111**) evaluates to:

$$2^6 + 2^5 + 2^4 + 2^2 + 2^1 + 2^0 = 119$$

Remember that the exponent is biased by 127 at the HP 3457. The real value is:

$$\text{exponent} - 127 = 119 - 127 = -8$$

The mantissa [1.10010000100100010010000 (MSB assumed "1")] evaluates to:

$$1 + 2^{-1} + 2^{-4} + 2^{-9} + 2^{-12} + 2^{-16} + 2^{-19} = 1.56471443177$$

The SREAL number is then calculated by:

$$-1 \times 2^{-8} \times 1.56471443177 = -6.1121657491\text{E-}3$$

## **Two's Complement Binary Coding**

Two's complement binary coding is a method that allows a binary number to represent both positive and negative integers. When a negative number is represented in the two's complement coding, its addition to another binary number actually accomplishes subtraction.

Two's complement coding is done by changing the sign and, in effect, the decimal equivalent of the most significant bit (leftmost). When this bit is set (1) in a one byte two's complement number, its value is  $1 \times -(2^7) = -128$ ; when reset (0), its value is  $0 \times -(2^7) = 0$ . Note that the range of a one byte two's complement number is -128 to 127 instead of the regular byte range of 0 to 255.

Converting a two's complement number to decimal is done the same way as for a regular binary number except that the most significant bit is negative.

### **EXAMPLE:**

Find the decimal equivalent of the following two's complement word:

10110101 10010110

The following equation is the equivalent of this two's complement word:

$$-(2^{15}) + 2^{13} + 2^{12} + 2^{10} + 2^8 + 2^7 + 2^4 + 2^2 + 2^1$$

This equation is equal to:

-19050

# Memories

The HP 3457 has three memory areas: reading storage, subprogram storage, and state storage. The total available memory is 2208 bytes which you can allocate to each of the three memory areas as your needs require. You allocate the memory using the MSIZE command. The MSIZE? query command reveals the present memory allocations.

## Reading Storage

Reading storage has two separate modes: FIFO (first-in-first-out) and LIFO (last-in-first-out). Whenever you specify either of these modes, you erase any previously stored readings. You can turn off memory storage (MEM OFF command) leaving all stored readings intact. Later you can resume the previously set mode (MEM CONT command) to store additional readings without clearing any previous storage. If you fill the reading memory in the FIFO mode, all stored data remains intact and you lose all new readings. If you fill reading memory using the LIFO mode, the oldest readings (those first stored) are replaced by the latest readings.

The MFORMAT command allows you to select the format of your stored readings. Executing this command also erases all previous readings. The memory formats are ASCII, single integer, double integer, and single real. The number of bytes listed for each format indicates the storage required for one reading.

**ASCII** The ASCII format uses 16 bytes per reading and is represented by:

**SD.DDDDDDESDD <CR> <LF>**

Where:

**S** = +/—

**D** = 0-9

**E** = base 10 exponent

This format should only be used when the OFORMAT is ASCII, measurement speed is not critical, and the number of readings to be stored is not great.

**Single Integer** The single integer (SINT) format is 16 bits (2 bytes) in two's complement coding (refer to "Two's Complement Binary Coding," in this chapter, for more information). This format should be used when making 3.5 or 4.5 digit resolution measurements at the fastest possible rate with autoranging off.

When using the SINT format, the HP 3457 applies a scale factor (some power of ten) to a reading to make it conform to the integer format. When recalling data, the HP 3457 calculates the scale factor using the present range, A/D configuration, and active math operations. If the data was stored using a different range, A/D configuration, or math operation, the scale factor may have been different. Therefore, it is important that when recalling data, regardless of the output format, the HP 3457 be configured the same as when the data was stored. Table 3-13 lists the SINT scale factors.

**Table 3-13. SINT Scale Factors**

Range	Digits Resolution			
	3.5	4.5	5.5	6.5
.0003	1E-7	1E-8	1E-8	1E-8
.003	1E-6	1E-7	1E-7	1E-7
.03	1E-5	1E-6	1E-6	1E-6
.3	1E-4	1E-5	1E-5	1E-5
3	.001	1E-4	1E-4	1E-4
30	.01	.001	.001	.001
300	.1	.01	.01	.01
3k	1	.1	.1	.1
30k	10	1	1	1
300k	100	10	10	10
3M	1E+3	100	100	100
30M	1E+4	1E+3	1E+3	1E+3
3G	1E+5	1E+5	1E+5	1E+5

---

**NOTE**

*When using autorange to store readings in the SINT format, a different scale factor may have been applied for each autorange selection. There is no way to recover each of the various scale factors.*

---

**Double Integer** The double integer (DINT) format is 32 bits (4 bytes) in two's complement coding (refer to "Two's Complement Binary Coding," in this chapter, for more information). This format should be used when making 5.5 digit resolution (or greater) measurements at the fastest possible rate with autoranging off.

When using the DINT format, the HP 3457 applies a scale factor (some power of ten) to each reading to make it conform to the integer format. When you recall a reading, the HP 3457 calculates the scale factor using the present range, A/D configuration, and enabled math operations. If the data was stored using a different range, A/D configuration, or math operation, the scale factor may have been different. Therefore, it is important that when recalling data, regardless of the output format, the HP 3457 be configured the same as when the data was stored. Table 3-14 lists the DINT scale factors.

**Table 3-14. DINT Scale Factors**

Range	Digits Resolution			
	3.5	4.5	5.5	6.5
.0003	1E-7	1E-8	1E-9	1E-10
.003	1E-6	1E-7	1E-8	1E-9
.03	1E-5	1E-6	1E-7	1E-8
.3	1E-4	1E-5	1E-6	1E-7
3	.001	1E-4	1E-5	1E-6
30	.01	.001	1E-4	1E-5
300	.1	.01	.001	1E-4
3k	1	.1	.01	.001
30k	10	1	.1	.01
300k	100	10	1	.1
3M	1E+3	100	10	1
30M	1E+4	1E+3	100	10
3G	10	10	10	10

**NOTE**

*When using autorange to store readings in the DINT format, a different scale factor may have been applied for each autorange selection. There is no way to recover each of the various scale factors.*

**Single Real** The single precision real format conforms to IEEE 754 specifications. This format is 32 bits (4 bytes) and is represented by:

**S EEE EEEE    E MMM MMMM    MMMM MMMM    MMMM MMMM**  
**byte 0                    byte 1                    byte 2                    byte 3**

Where:

**S** = sign bit (1 = negative 0 = positive)

**E** = base two's exponent biased by 127 (to "decode" these 8 bits, subtract 127 from their integer equivalent).

**M** = 23 mantissa bits (those right of the radix point). There is an “implied digit” to the left of the radix point. This digit is always assumed to be “1”. This provides an effective precision of 24 bits with the least significant bit (right most) weighted  $2^{-23}$ . Another way to evaluate this mantissa is to convert these 24 bits (most significant bit assumed “1”) to an integer and then multiply by  $2^{-23}$ .

The value of a number in the SREAL format is calculated by:

$$(-1)^S \times (\text{mantissa}) \times 2^{(\text{exponent})}$$

The SREAL format should be used when making measurements at the fastest possible rate with autoranging on.

## Recalling Readings

There are two methods for recalling readings from memory. One method removes the reading from memory and the other merely copies the reading to the output buffer. Regardless of the format used to store the data in memory, the recalled data is in the format specified in the OFORMAT command. Note that the only method for retrieving stored readings using the front panel is with the RMEM command (the copying method).

The method that removes the reading from memory is called the “implied read.” This is done by requesting data from the HP 3457 when its output buffer is empty and reading memory is in the FIFO or LIFO mode. In this case, one reading, either the first or last depending on storage mode, is sent from memory to the output buffer and on to the controller via HP-IB. This implied read method allows you to continuously take readings and store them while simultaneously extracting previously stored readings.

The other method uses the RMEM command and can select any reading from memory regardless of storage mode (FIFO or LIFO) or position. The RMEM command’s parameters specify from which record, which beginning data item, and how many subsequent readings that you wish to select. This command first turns the memory storage mode OFF. When executing RMEM from the front panel, use the up or down arrow keys to sequentially copy data to the display. RMEM executed over HP-IB copies data to the output buffer one item at a time until the RMEM list is satisfied or the end of memory is reached. This copy only occurs after requesting data output via HP-IB and the output buffer was previously empty.

## Subprogram Storage

The HP 3457 can locally store command strings as subprograms. This allows you to execute frequently used command strings and keep bus/controller interactive time to a minimum. You can store as many as 20 subprograms. The memory size allocated is the only limit on the length of these subprograms.

Use the SUB and the SUBEND commands to store a subprogram. The SUB command indicates the start of the subprogram and its title (the title is an integer from 0 to 19). Following the SUB command, you enter the subprogram commands in the order you want them executed. Use the SUBEND command to indicate the end of the subprogram.

To execute a stored subprogram, issue the CALL command along with the subprogram's title.

You can temporarily suspend subprogram execution using the PAUSE command. The HP 3457 executes subprograms on a command-by-command basis. When it encounters the PAUSE command, subprogram execution is suspended. Subprogram execution resumes only when the HP-IB Group Execute Trigger (TRIGGER 7) is received.

If the input buffer is off, the HP 3457 does not release the bus until the completion of the subprogram. If a command or more than one delimiter (such as the typical <CR> <LF>) follows the CALL command, the controller is forced to wait until the end of the subprogram before it can resume processing. With the input buffer on, bus operation continues as normal. Additional commands sent over the bus will be temporarily stored until the end of the subprogram. However, if you overflow the input buffer, bus operation will be halted until the end of the subprogram. If you send the HP-IB Device Clear or Selected Device Clear command, the HP 3457 immediately aborts the subprogram.

To clear all subprograms from memory, issue the SCRATCH command or re-allocate memory. You cannot selectively scratch any one subprogram. If you create a new subprogram using the same name as an existing subprogram, the new subprogram will appear to overwrite the old subprogram. The old subprogram is still in memory, but you cannot access it. This means that there must be enough memory space (MSIZE command) to store both subprograms. If you run out of memory space while storing a subprogram, the HP 3457 sets the syntax error bit in the error register.



You can determine the memory space needed to store a subprogram as follows:

- header "SUB name;" or "SUB name<CR><LF>" .....none
- any command header.....2 bytes
- comma or space delimiter.....1 byte
- any parameter.....1 byte per character
- semicolon delimiting commands in command string \*.....2 bytes
- <CR><LF> \* .....2 bytes
- SUBEND command.....2 bytes

\* If several delimiters are sent in succession (i.e.,<CR><LF>EOI), only the first one is stored.

The <CR><LF> is included in the above because if you send the subprogram's commands using several controller OUTPUT statements, each output typically has a <CR><LF> end of line terminator. Notice that if you suppress the end of line terminator, the HP 3457 still requires the semicolon delimiter between commands. The most efficient method to store a subprogram is to use numeric equivalents for parameters or, where possible, use defaults.

**EXAMPLE:** determine the subprogram storage requirement for the following command string: SUB 1;DCV 30,.01;TRIG SGL;NRDGS 5,AUTO;SUBEND

SUB,1;	.....0 bytes
DCV	.....2 bytes
,30,.01	.....7 bytes
;	.....2 bytes
TRIG	.....2 bytes
,SGL	.....4 bytes
;	.....2 bytes
NRDGS	.....2 bytes
,5,AUTO	.....7 bytes
;	.....2 bytes
SUBEND	.....2 bytes
total.....	<u>32 bytes</u>

## State Storage

The HP 3457 can store any *configuration* in state memory. The *configuration* includes the measurement function (AC voltage, DC voltage, etc.), range, resolution, NPLC, and so on. There is always enough memory for one state storage, regardless of what you specify in the MSIZE command. This state is in non-volatile RAM. If you leave enough room for eleven or more states in the MSIZE command, the first eleven states (0 - 10) will be in non-volatile RAM. In the event of a power loss, the HP 3457 automatically stores the present configuration as state 0.

The SSTATE command stores the present state in a numbered memory location (0 through 30). The RSTATE command recalls a state from memory. You can use SSTATE location 0, but it will be overwritten with the current configuration at power down.

## Triggering

Before the HP 3457 will begin a measurement or a series of measurements, three separate events must be satisfied in the proper order. These are (1) the trigger arm event, (2) the trigger event, and (3) the sample event. When all three events have been satisfied in the order listed, the HP 3457 begins to make the specified measurement(s). We will refer to this specified measurement or series of measurements as a *measurement cycle*. In the power-on state, the HP 3457 satisfies these three events automatically.

### The Trigger Arm Event

The occurrence of the trigger arm event arms the HP 3457's triggering mechanism. In other words, the trigger arm event enables a subsequent trigger event. This can be compared to cocking a pistol, preparing it to be fired.

You specify the trigger arm event using the TARM command. The TARM command has two parameters. The first parameter specifies the trigger arm event. The second parameter specifies the number of measurement cycles for each arming. However, you can only use the second parameter when you specify SGL (single) as the first parameter.

The TARM? query command reveals the presently selected trigger arm event.

## The Trigger Event

The trigger event enables the ensuing sample event. Continuing with the pistol analogy, this is similar to releasing the safety mechanism that locks the pistol's trigger.

You specify the trigger event using the TRIG command or its abbreviation, the T command. The TRIG? query command reveals the presently selected trigger event.

## The Sample Event

The sample event has a dual purpose. First it specifies how many measurements are to be taken in the measurement cycle. Secondly, it specifies the event that initiates these measurements. Back to the pistol, this compares to how many shells were placed in the magazine. Then, for each subsequent pull of the pistol's trigger, the pistol fires until the magazine runs out of shells. At this point, the entire process must be repeated before another firing (measurement cycle) can occur.

You specify the sample event and the number of readings per measurement cycle using the NRDGS command. The NRDGS? query command reveals the sample event and the number of readings presently selected.

## Event Choices

You can select from a variety of events to satisfy the trigger arm, the trigger, and the sample events. The following AUTO, EXT, and SYN events can be used as the trigger arm, the trigger, and the sample events.

**AUTO** AUTO (automatic) occurs automatically whenever it is required.

**EXT** EXT (external) is caused by the negative edge transition of a TTL pulse on the rear panel's external trigger terminal (Figure 3-7). The minimum pulse width recognized is 250 ns. The input is protected through a voltage range of -5 volts to +5 volts.

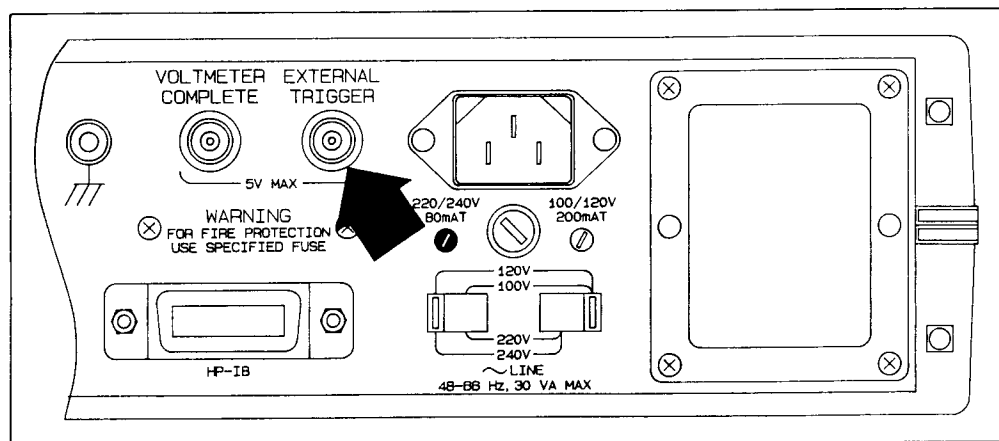


Figure 3-7. Rear Panel External Terminal

---

## NOTE

*The TBUFF command corrects for a TRIGGER TOO FAST error that can occur when using external trigger. With TBUFF OFF, any external triggers occurring during a measurement generate the TRIGGER TOO FAST error and the triggers are ignored. With TBUFF ON the first external trigger occurring during the measurement is stored and no error is generated by this or any successive triggers. After the measurement is complete, the stored trigger initiates a new measurement.*

---

**SYN** SYN (synchronous) occurs when the HP 3457's output buffer is empty, reading memory is off or empty, and the controller requests data. When used as the sample event (NRDGS command), SYN initiates one measurement and places the reading into the output buffer and then onto HP-IB. When used as the trigger arm or trigger event, the HP 3457 holds the HP-IB bus until a reading becomes available. This means the succeeding events (trigger event and/or sample event) must be satisfied before a reading is placed into the output buffer and onto the bus. Only then will the bus and controller be released.

The following SGL and HOLD events can only be used as the trigger arm and the trigger events.

**SGL** SGL (single) satisfies the trigger arm or the trigger event once upon receipt of the TARM SGL or TRIG SGL command. Afterwards, the event becomes HOLD.

If the input buffer is off, the HP 3457 holds the bus until the completion of the measurement cycle. If a command or more than one delimiter (such as the typical <CR> <LF>) follows the TARM SGL or TRIG SGL command, the controller is forced to wait until the end of the measurement cycle before it can resume processing. With the input buffer on, bus operation continues as normal. Additional commands sent over the bus are temporarily stored until the end of the measurement cycle. However, if you overflow the input buffer, the HP 3457 holds the bus until the end of the measurement cycle. You can abort the measurement cycle by sending the HP-IB Device Clear or Selected Device Clear command.

The HP-IB Group Execute Trigger command causes the HP 3457 to behave as if the command TRIG SGL had been executed. Additionally, when the HP 3457 is properly configured, you can generate a single trigger using the ? command (remote only).

**HOLD** This event suspends triggering. You can re-enable triggering by specifying another event.

**TIMER** TIMER can only be used as the sample event. TIMER is useful when you are making more than one reading per measurement cycle. This event is similar to AUTO except that a time interval is placed between each reading. You specify this interval using the TIMER command. The TIMER? query command reveals the presently programmed interval.

---

**NOTE**

*When using the TIMER event, autorange is disabled.*

---

**Delay** The DELAY command specifies a time interval to be placed between the event that actually initiates the measurement and the beginning of that measurement. The DELAY? query command reveals the delay that is presently applied to measurements. Note that the event initiating a measurement can be associated with the TRIG event if NRDGS is set up to be satisfied automatically. Similarly, the trigger arm event can initiate a measurement cycle if both the trigger and sample events are satisfied automatically. When using the default value for DELAY, the HP 3457 automatically determines the delay time needed for accurate measurements. Table 3-15 contains the default delay times for all functions, ranges, and resolutions (see Table 3-1 for the relationship of resolution and the A/D converter's configuration).

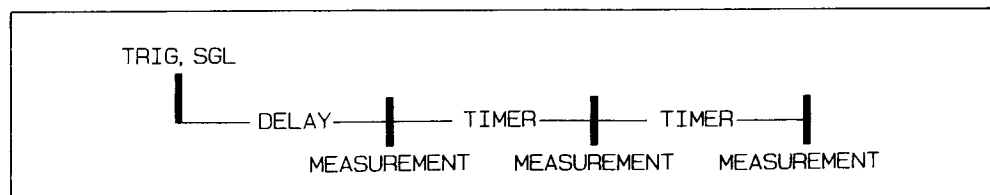
---

**NOTE**

*You can specify a shorter DELAY than the default value. However, the resulting settling time may not be adequate to assure accurate readings.*

---

An interaction occurs between the DELAY command and the TIMER parameter in the NRDGS command. This is shown in Figure 3-8 with NRDGS = 3 and TRIG = SGL.



**Figure 3-8. Timer/Delay Sequence**

**Table 3-15. Default Delay Times**

Measurement Function	Range	DELAY Defaults for number of Digits Resolution			
		3.5	4.5	5.5	6.5
DCV	.03 V	0.32 ms	0.39 ms	0.46 ms	0.56 ms
DCV	.3-300 V	0.2 ms	0.24 ms	0.29 ms	0.35 ms
*ACV (ACBAND = Fast)	Any	100 ms	100 ms	100 ms	100 ms
*ACV (ACBAND = Slow)	Any	1000 ms	1000 ms	1000 ms	1000 ms
*ACDCV (ACBAND = Fast)	Any	100 ms	100 ms	100 ms	100 ms
*ACDCV (ACBAND = Slow)	Any	1000 ms	1000 ms	1000 ms	1000 ms
OHM (2 & 4-wire)	30Ω	0.32 ms	0.39 ms	0.46 ms	0.56 ms
OHM (2 & 4-wire)	300-30kΩ	0.2 ms	0.24 ms	0.29 ms	0.35 ms
OHM (2 & 4-wire)	300kΩ	0.72 ms	0.88 ms	1 ms	1.2 ms
OHM (2 & 4-wire)	3MΩ	7.2 ms	8.8 ms	10 ms	12 ms
OHM (2 & 4-wire)	30MΩ	72 ms	88 ms	100 ms	120 ms
OHM (2 & 4-wire)	3GΩ	720 ms	880 ms	1000 ms	1200 ms
DCI	Any	0.2 ms	0.24 ms	0.29 ms	0.35 ms
*ACI (ACBAND = Fast)	Any	100 ms	100 ms	100 ms	100 ms
*ACI (ACBAND = Slow)	Any	1000 ms	1000 ms	1000 ms	1000 ms
*ACDCI (ACBAND = Fast)	Any	100 ms	100 ms	100 ms	100 ms
*ACDCI (ACBAND = Slow)	Any	1000 ms	1000 ms	1000 ms	1000 ms
FREQ (ACBAND = Fast)	Any	100 ms	100 ms	100 ms	100 ms
FREQ (ACBAND = Slow)	Any	1000 ms	1000 ms	1000 ms	1000 ms
PER (ACBAND = Fast)	Any	100 ms	100 ms	100 ms	100 ms
PER (ACBAND = Slow)	Any	1000 ms	1000 ms	1000 ms	1000 ms

\* The above values assume the range and function have been selected for at least one measurement. Whenever you change a range or measurement function, the first measurement has the following delay values added to those above. Table 3-16 shows the added delays caused by changing ranges. Table 3-17 shows the added delays caused by changing measurement functions.

**Table 3-16. Added Delay for Range Change**

Measurement Function	ACBAND	Change to Range	Added DELAY
ACV	Fast	30 mV	900 ms
ACV	Fast	300 mV	700 ms
ACV	Fast	Others	0 ms
ACV	Slow	30 mV	500 ms
ACV	Slow	Others	100 ms
ACDCV	Fast	Any	0 ms
ACDCV	Slow	Any	100 ms
ACI	Fast	Any	0 ms
ACI	Slow	300 mA	100 ms
ACI	Slow	Others	0 ms
ACDCI	Fast	Any	0 ms
ACDCI	Slow	300 mA	100 ms
ACDCI	Slow	Others	0 ms

**Table 3-17. Added Delay for Function Change**

Change to Function	ACBAND	Range	Added Delay
ACV	Fast	30 mV	1000 ms
ACV	Fast	300 mV	800 ms
ACV	Fast	Others	100 ms
ACV	Slow	30 mV	800 ms
ACV	Slow	Others	400 ms
ACDCV	Fast	Any	100 ms
ACDCV	Slow	Any	400 ms
ACI	Fast	300 mA	800 ms
ACI	Fast	Others	0 ms
ACI	Slow	300 mA	400 ms
ACI	Slow	Others	0 ms
ACDCI	Fast	300 mA	100 ms
ACDCI	Fast	Others	0 ms
ACDCI	Slow	300 mA	400 ms
ACDCI	Slow	Others	0 ms

## Triggering Tips

The following tips are important to remember when using the various triggering events.

- The TARM SGL and TRIG SGL events do not function together. For example, when the TARM event is SGL and you send TRIG SGL, the HP 3457 sets the TARM event to HOLD.
- You should never need to use a SGL event and a SYN event together. If you do, however, you must enable the HP 3457's input buffer. When the input buffer is not enabled, both of these events attempt to hold the HP-IB bus until the measurement(s) are complete. This means the first event holds the bus, making it impossible for the next event to occur.
- When using SYN for more than one event (e.g., TARM SYN; TRIG SYN; NRDGS 2,SYN) a single occurrence of SYN satisfies all events.
- The voltmeter complete pulse occurs after each individual reading. This is important to remember when making multiple measurements per sample event with the NRDGS command.
- For most applications, you will need to use only one or two triggering events. The fewer the events (the more that are AUTO) the simpler the operation.

## Triggering Examples

These examples illustrate how the triggering commands interact. Examples 1 and 2 assume the HP 3457 has already been configured for the desired measurement.

The commands are listed as if they were sent one by one. If you sent them as one long command string, each command would have to be separated by a semicolon (;).

**Example #1** You need to take 7 readings at a rate of one reading per second. The HP-IB Group Execute Trigger command will initiate these readings:

**TRIG HOLD**—suspends triggering until the receipt of another TRIG command or the HP-IB Group Execute Trigger (TRIGGER 7).

**TARM AUTO**—automatically arms triggering.

**TIMER 1**—instructs the HP 3457 to place a one second interval between readings

**DELAY**—since there is no parameter sent with this command, it instructs the HP 3457 to use the default value which is the minimum necessary for accuracy.

**NRDGS 7, TIMER**—instructs the HP 3457 to take 7 readings and to automatically initiate each reading at one second intervals. This occurs after the HP 3457 has received the appropriate trigger arm and trigger events.

**TRIGGER 7**—this is an HP BASIC command that causes an HP-IB Group Execute Trigger (on interface select code 7). This satisfies the trigger event and the HP 3457 now takes the readings as specified in the NRDGS command.

**Example #2** You have a continuous, nonperiodic pulse train connected to the rear EXT trigger terminal. You want each pulse to trigger 1 reading and then store each reading in memory. You want to take 100 readings and then stop:

**TRIG HOLD**—blocks the triggering mechanism to temporarily prevent measurements from being taken and stored.

**TARM AUTO**—instructs the HP 3457 to automatically satisfy the trigger arm event whenever required.

**MFORMAT SREAL**—specifies that the readings are to be stored in the single real format (4 bytes per reading).



**MSIZE 400**—allocates 400 bytes of memory to reading storage. This was calculated by 100 readings x 4 bytes per reading = 400 bytes.

**MEM FIFO**—clears any previous readings from memory and then configures storage for first-in-first-out access.

**NRDGS 100,EXT**—one reading will be taken per pulse present at the EXT trigger terminal until 100 readings have been taken.

**TRIG SGL**—triggers the HP 3457 for one measurement cycle. Since the trigger arm event is AUTO, each of the next 100 pulses received at the EXT terminal initiates a measurement.

**Example #3** You want to digitize the noise and pulses present during the settling time of a positional control process. The settling time is less than 50 ms. The pulse that starts the positional control also initiates readings for 50 ms. The HP 3457 must be totally dedicated to this process. At the same time, the system controller must be free for other computation. You would like audio indication when the HP 3457's memory is full and an interrupt to initiate rapid data transfer. After the data transfer is complete, the entire process will be repeated.

For this application, you must maximize efficiency. To do this, you will use the input buffer, subprogram storage, and the SRQ interrupt. You must create a routine for your controller that responds to an SRQ interrupt by checking the status byte. This ensures that the program execution complete bit caused the SRQ. After verifying the status byte, the interrupt routine should enter all stored readings, call the HP 3457's stored subprogram to initiate another batch of readings, and manipulate and archive the received data.

To make the best use of controller time, all of the following commands should be sent as one long command string. Individual commands in the string are separated by semicolons, that is: **INBUF ON;MSIZE 1000,150;SUB 1;...**

**INBUF ON**—allows the controller to perform other operations while the HP 3457 is processing commands.

**DCV 30,.1**—sets the HP 3457 to make DC voltage measurements up to 30 V. By specifying the range, this command automatically turns autorange off. This command also specifies a resolution that sets the A/D converter to make measurements at its fastest rate.

**AZERO OFF**—turns autozero off so that only one zero offset measurement is made for this burst of readings.

**DELAY 0**—sets the delay between the measurement event and the measurement to 0. Note that by doing this, the very first measurement of the following burst of readings may not be accurate due to insufficient settling time. However, subsequent readings will be accurate because the amplitude difference between any one reading and the next will not be very great.

**DISP OFF**—turns the display off which enables a faster reading rate.

**LOCK ON**—disables the front panel keyboard which enables a faster reading rate.

**EMASK 2047**—enables any error to be logged in the status register.

**RQS 105**—enables the following bits to cause an SRQ interrupt: subprogram memory execution complete, power-on, error as set in the error register, and service requested.

**TARM HOLD**—prevents any readings from being taken until the proper time in this command sequence.

**MSIZE 1000,150**—reserves 1000 bytes for reading storage (500 readings stored in the single integer format) and 150 bytes for subprogram storage. This command also clears any previously stored readings or subprograms.

**MEM FIFO**—erases any previous reading memory and specifies following readings to be stored on a first-in-first-out basis.

**MFORMAT SINT**—the memory format will be single integer.

**OFORMAT SINT**—the output format will be in single integer and have a scale factor of 0.01 as determined by RANGE 30 and NPLC .0005. This permits the fastest possible data transfer.

**TRIG EXT**—sets the trigger event to external. This event will be satisfied by a pulse on the EXT trigger terminal.

**NRDGS 50,AUTO**—after the external trigger, 50 readings will be automatically taken as fast as possible and stored in memory.

**SUB 1**—initiates subprogram storage. All following commands are stored in memory until the receipt of the SUBEND command.

**TARM SGL,10**—arms the HP 3457 for 10 measurement cycles. Note that during these measurement cycles the HP 3457 is totally dedicated to making these measurements.

**BEEP ONCE**—causes the HP 3457 to beep once after the above 10 measurement cycles (in this case 500 readings).

**SUBEND**—terminates subprogram storage.

**CALL 1**—instructs the HP 3457 to execute the stored subprogram.

# Maximizing Throughput

The following commands configure the HP 3457 to make the fastest possible series of measurements. Not shown are the F10 through F58 commands (remote only) or the ? command. The F10 through F58 commands rapidly configure the HP 3457 to make DC voltage, 2-wire or 4-wire ohms measurements. The ? command generates a single trigger.

```
PRESET
DISP OFF
LOCK ON
DCV 30
NPLC 0
AZERO 0
MFORMAT SINT
DELAY .1
MEM FIFO
TIMER 740EE6 7A0E-6
NRDGS *,TIMER
TRIG SGL
```

\* Specify the required number of readings.

## Self-Tests

The HP 3457 has a power-on self-test and a complete self-test.

### The Power-On Self-Test

The power-on self-test occurs automatically whenever the HP 3457 is turned on. This limited test takes approximately 1.5 seconds and basically assures you that the HP 3457 is capable of operating. This test does not necessarily indicate that measurements will be accurate. The power-on self-test performs (1) a master processor test, (2) a slave processor test, and (3) an isolation test. These are three of the ten tests performed by the complete self-test.

### The Complete Self-Test

You initiate this test using the TEST command. The complete self-test runs a series of ten tests. It takes about 7 seconds to run all of these tests. If all the tests pass, you have a high confidence level that the HP 3457 is operational and measurements will be accurate.

If a test fails, it sets a bit in the auxiliary error register. Refer to “The Auxiliary Error Register,” in this chapter, for a description of the possible self-test failures.

# Calibration

The HP 3457 has two forms of calibration; formal calibration and autocalibration. The formal calibration is enabled using the CAL command. This requires a procedure using external reference sources. This is a service related operation and is documented in the HP 3457 Service Manual.

The CALNUM? query command returns a number indicating the number of times your HP 3457 has been formally calibrated. By routinely monitoring this number, you can determine when calibrations have been performed and whether or not an unauthorized calibration has been done.

There are two autocal routines; AC and OHMS. The AC autocal increases short term accuracy for AC or AC+DC voltage and AC or AC+DC current measurements. The OHMS autocal increases short term accuracy of the 3 G $\Omega$  range for 2-wire and 4-wire ohms measurements.

You specify one or both of the autocal routines using the ACAL command. Perform autocal whenever you are making one of the above measurements and the HP 3457 has been exposed to any environment change (temperature, humidity, a long time since the last autocal, and so on). The HP 3457 will indicate if there is an autocal related problem by setting the autocal required bit in the error register. If this occurs, run both autocal routines. If the problem still exists, run the complete self-test (TEST command) to check for a hardware error. If you cannot eliminate the error, refer to the HP 3457 Service Manual.

# The Status Register

The status register contains information mainly related to the results of a measurement or a group of measurements. When a bit(s) of this register is set and has been enabled to assert SRQ by the RQS command, the HP 3457 sets the HP-IB SRQ line true. This is useful to alert the controller to interrupt its present operation and find out what service the HP 3457 requires.

There are two ways to read the contents of the status byte; the STB? query command, and the HP-IB serial poll command.

The STB? query command only reads the status byte and does not change it. Note that the STB? query cannot reveal bit 4 (ready) set because the HP 3457 is busy processing the query command and, therefore, is not ready.

The serial poll (SPOLL) automatically sends the register's contents over HP-IB. If the SRQ line was true, all bits of the register are cleared if the condition that set the bit(s) is no longer present. The SRQ line is also returned to false if bit 6 is cleared. If the SRQ line was false during SPOLL, the register's contents are not changed.

You can clear the status byte using the CSB command.

The following list defines the meaning of each set bit of the status byte.

Bit 0 (weight = 1) PROGRAM COMPLETE—indicates that a stored subprogram has been executed.

Bit 1 (weight = 2) HI/LOW—indicates that the high or low limit of the PFAIL math operation has been exceeded.

Bit 2 (weight = 4) FRONT PANEL—indicates that the SRQ command has been executed from the front panel. Note that the SRQ command sent over HP-IB sets bit 6 but not bit 2.

Bit 3 (weight = 8) POWER-ON—indicates that a power-on cycle has occurred.

Bit 4 (weight = 16) READY—indicates that the HP 3457 has completed execution of all commands and is ready to accept more commands or trigger events. Note that this bit can be set even when the HP 3457 appears to be busy making measurements. This bit can be used to indicate when a group of measurements is completed if the TRIG SGL or TARM SGL command was used to trigger the group of measurements.

Bit 5 (weight = 32) ERROR—indicates that an error has been logged in the error register. You must read the error register to identify the source. For this bit to be set, you must enable the appropriate error register bit(s) using the EMASK command.

Bit 6 (weight = 64) SERVICE REQUEST—indicates that service is requested and the SRQ line is set true. This bit can be set in one of two ways: (1) when any other bit of this register is set and has been enabled to assert SRQ by the RQS command and (2) the SRQ command was issued over HP-IB.

It is possible for bit 6 to be the only bit set such as when the SRQ command from the controller sets bit 6. Another example is when an error set a bit in the error register which, in turn, set bit 6. Later, the error register was read which removed the error bit but left bit 6 set. A third example is when the status register's ready bit was set and set bit 6. Later, the ready bit became "busy" and left bit 6 set.

To allow any of the above bits (except bit 6) to set the SRQ line true, you must first enable them with the RQS command. For example, suppose your application requires an interrupt if a high or low limit is exceeded, an error occurs, or if the HP 3457's power is cycled. Referring to the above list, these correspond to bits 1, 3, and 5, respectively. The weights of these bits are  $2^1$ ,  $2^3$ , and  $2^5$  which evaluates to 2, 8, and 32. The sum of these weights is 42. You must issue the RQS 42 command to enable these conditions to set bit 6 and assert SRQ. Notice that the bits that are not enabled still respond to their corresponding conditions. They do not, however, set bit 6 or assert SRQ.

# The Error Register

The error register contains information about programming and software errors. When one of these errors occurs, it sets the corresponding bit in the error register. The HP 3457 indicates an error occurred by beeping once (if the beeper is enabled) and flashing the display's error annunciator (ERR). Whenever any bit is set and has been enabled by the EMASK command, the error bit in the status register is set.

There are two methods for reading this register. One method uses the ERR? query command. The other uses the shifted ERROR key located to the right of the numeric keys.

The ERR? query command returns the weighted sum of the error register's contents.

Pressing the shifted ERROR key writes the number of the first set bit and its description to the display. If there is more than one error logged in the error register, the ERR annunciator will continue to flash. Press SHIFT—ERROR again to retrieve the next error. Continue pressing SHIFT—ERROR until all errors are retrieved.

The error conditions and their weighted values are:

Bit 0 (weight = 1) **HARDWARE**—indicates that a hardware error has occurred. Read the auxiliary error register to find the source of the error.

Bit 1 (weight = 2) **CALIBRATION**—indicates that an error has occurred during either the CAL or ACAL calibration process.

Bit 2 (weight = 4) **TRIGGER TOO FAST**—indicates that you are triggering too fast. This happens when trigger events occur at a higher frequency than the period allowed in the DELAY command plus the maximum reading rate.

Bit 3 (weight = 8) **SYNTAX**— This bit is only set when there is a syntax error that is not defined by any other bit in this register. For example, when storing commands in subprogram memory and you run out of memory space.

Bit 4 (weight = 16) **BAD HEADER**—indicates that an unrecognizable command was sent.



Bit 5 (weight = 32) BAD PARAMETER—indicates that an unrecognizable or mismatched parameter was sent along with a command.

Bit 6 (weight = 64) PARAMETER RANGE—indicates that the parameter sent was out of range (such as sending a number greater than 255 with the RQS command).

Bit 7 (weight = 128) PARAMETER REQUIRED—indicates that a parameter was missing for a command that has no default.

Bit 8 (weight = 256) PARAMETER IGNORED—indicates that a parameter was ignored. This happens when sending a parameter with a command that requires no parameters, sending an extra parameter with a command that requires parameters, or when sending a parameter with an unrecognizable command.

Bit 9 (weight = 512) NOT CALIBRATED—indicates that the HP 3457 is not calibrated or that the present calibration constants are bad. Refer to the HP 3457 Service Manual for the procedure on recalibrating.

Bit 10 (weight = 1024) AUTOCAL REQUIRED—indicates that you must perform an autocalibration (ACAL command).

If you want certain errors to be indicated by the error bit in the status register, you must enable those bits with the EMASK command. For example, let's say that you are interested in knowing the occurrence of a hardware error, bad command, or a missing parameter. These conditions correspond to bits 0, 5, and 7, respectively, of the preceding list. These bits are weighted  $2^0$ ,  $2^5$ , and  $2^7$ , which evaluated equals 1, 32, and 128. The weighted sum of these bits is 161, so executing "EMASK 161" enables these error conditions to set the error bit in the status register. Normally, you should leave all bits enabled (EMASK 2047).

## The Auxiliary Error Register

The auxiliary error register contains information about hardware errors. Bits 1 through 8 and 10 through 14 are the results of the self-test (refer to the "Self-Tests," in this chapter, for more information). Bits 7 through 9 may be set by errors during ACAL. Whenever any of the auxiliary error register's bits are set, the hardware error bit in the error register is also set. This allows you to determine if a hardware error occurred without having to read the auxiliary error register. Refer to the HP 3457 Service Manual for procedures on correcting these types of errors.

You read the auxiliary error register using the AUXERR? query command. Once read, the auxiliary error register is cleared.

The auxiliary error conditions and their weighted values are:

Bit 0 (weight = 1)—isolation error during HP 3457 operation in any mode (self-test, ACAL, measurements, etc.)

Bit 1 (weight = 2)—slave processor self-test failed.

Bit 2 (weight = 4)—isolation self-test failed.

Bit 3 (weight = 8)—integrator convergence error.

Bit 4 (weight = 16)—front end zero measurement error.

Bit 5 (weight = 32)—current source, gain selection, or input divider failure.

Bit 6 (weight = 64)—amps self-test failed.

Bit 7 (weight = 128)—AC amplifier's DC offset check failed.

Bit 8 (weight = 256)—AC self-test failed.

Bit 9 (weight = 512)—ohm's precharge failure during ACAL.

Bit 10 (weight = 1024)—32k ROM failure.

Bit 11 (weight = 2048)—8k ROM failure.

Bit 12 (weight = 4096)—non-volatile RAM test failed.

Bit 13 (weight = 8192)—volatile RAM test failed.

Bit 14 (weight = 16384)—calibration RAM protect circuit failure.

## The Front Panel

This section describes the commands that pertain to the HP 3457's keyboard and display. A more detailed discussion of how to operate the HP 3457 from its keyboard is in Chapter 2 under "Operating from the Front Panel."

## The Keyboard

The LOCK and SRQ commands pertain to the keyboard. The LOCK command, which can be executed only from remote (HP-IB), disables the HP 3457's keyboard.

The front panel SRQ key sets the front panel SRQ bit in the HP 3457's status register. If the status register is properly enabled, the SRQ interface control line is also set true (refer to "The Status Register," in this chapter, for more information). When sent from remote, the SRQ command does not set the front panel SRQ bit in the status register. However, it does set the HP-IB SRQ line true. This is useful for testing and debugging your controller's interrupt routines.

## The LCD Display

The HP 3457 has a 12 character alphanumeric LCD display. The displays buffer holds 24 characters. For displays in excess of 12 characters, you can view the extra characters using the left or right arrow key.

## Power-on Mode

In the power-on mode, the HP 3457 displays DC voltage measurements containing 6 digits. The most significant digit (leftmost), however, can only be 0, 1, 2, or 3. In this manual, we will refer to this digit as a ½ digit. In the power-on mode, then, the HP 3457 is displaying 5½ digit DC voltage measurements.

Along the bottom of the display are 12 triangular annunciators. These indicate the HP 3457's present operating conditions. The following list describes each of these annunciators, reading from left to right.

SMPL—(sample) flashes to indicate a measurement has been completed. The maximum display rate (for readings and annunciators) is five updates per second. This means that for every reading displayed, the HP 3457 may have made many readings.

REM—(remote) on when the HP 3457 is being controlled remotely over HP-IB.

SRQ—(service request) on when the HP 3457 is asserting service request.

ADRS—(address) on when the HP 3457 has been addressed to listen or talk.

AC + DC—on when making DC coupled AC voltage or current measurements.

4WΩ—on when making 4-wire ohms measurements.

AZOFF—on when autozero is off.

MRNG—(manual range) on when autorange is off.

MATH—on when one or more math operations are active.

REAR—on when using either the rear terminals or a plug-in card channel.

ERR—flashes when an error condition is stored in the error register.

SHIFT—on after you press the blue shift key.

**Display Control** You can vary the number of digits displayed using the NDIG command. With the DISP command, you can:

- Turn the display on for normal (power-on mode) operation.
- Turn the display off; no readings or annunciators.
- Display a custom message for approximately 3 minutes, without annunciators. After 3 minutes the display turns off.
- Display a custom message, with active annunciators.

## HP-IB Address

The HP 3457's factory HP-IB address setting is 22. You can read the present address using the shifted ADRS key on the HP 3457's front panel. You can also change the address from the HP 3457's front panel. Procedures showing how to read and change the HP-IB address are in Chapter 2 under "Operating from Remote".

## Identity

The ID? command returns the response "HP3457A". This allows you to easily locate the HP 3457, by its address, from remote.

# Beeps and Tones

With BEEP enabled (BEEP ON command) the HP 3457 beeps whenever it detects an error. The beep is a set frequency of 1 kHz and lasts about 0.2 seconds. You can disable the beeper (BEEP OFF command) and the HP 3457 no longer beeps on errors. The beeper on/off setting is stored in non-volatile RAM and is preserved when power is removed or the HP 3457 is turned off.

The HP 3457 uses a 500 Hz tone to indicate the end of the power-on sequence. This is not considered a beep and is unaffected by the BEEP command.

The TONE command allows you to specify the frequency and duration of a tone generated by the beeper. You can specify frequencies from 1 Hz to 5 kHz. You specify the duration in milliseconds.





# CONTENTS

	Page		Page
Introduction .....	4-1	MEM .....	4-79
Reading a Syntax Diagram .....	4-2	MFORMAT .....	4-81
Language Conventions .....	4-4	MSIZE .....	4-83
Sending Commands .....	4-4	MSIZE? .....	4-85
Parameters .....	4-5	NDIG .....	4-86
Defaulting Parameters .....	4-5	NPLC .....	4-88
ACAL .....	4-7	NPLC? .....	4-91
ACBAND .....	4-9	NRDGS .....	4-92
ACDCI .....	4-10	NRDGS? .....	4-94
ACDCV .....	4-13	OCOMP .....	4-95
ACI .....	4-16	OCOMP? .....	4-96
ACV .....	4-19	OFORMAT .....	4-97
ADDRESS .....	4-22	OHM .....	4-101
ARANGE .....	4-24	OHMF .....	4-104
AUXERR? .....	4-25	OPEN .....	4-107
AZERO .....	4-27	OPT? .....	4-109
AZERO? .....	4-28	PAUSE .....	4-110
BEEP .....	4-29	PER .....	4-112
CAL .....	4-30	PRESET .....	4-114
CALL .....	4-31	R .....	4-115
CALNUM? .....	4-32	RANGE .....	4-116
CHAN .....	4-33	RANGE? .....	4-119
CHAN? .....	4-35	RESET .....	4-120
CLOSE .....	4-36	REV? .....	4-122
CRESET .....	4-37	RMATH .....	4-123
CSB .....	4-38	RMEM .....	4-125
DCI .....	4-39	RQS .....	4-127
DCV .....	4-42	RSTATE .....	4-129
DELAY .....	4-45	SADV .....	4-131
DELAY? .....	4-46	SCRATCH .....	4-133
DIAGNOSTIC .....	4-47	SECURE .....	4-134
DISP .....	4-48	SLIST .....	4-135
EMASK .....	4-50	SLIST? .....	4-137
END .....	4-51	SMATH .....	4-138
ERR? .....	4-52	SRQ .....	4-140
F10-F58 .....	4-54	SSTATE .....	4-141
FIXEDZ .....	4-56	STB? .....	4-143
FIXEDZ? .....	4-57	SUB .....	4-145
FREQ .....	4-58	SUBEND .....	4-147
FSOURCE .....	4-60	T .....	4-148
FUNC .....	4-61	TARM .....	4-149
ID? .....	4-65	TARM? .....	4-152
INBUF .....	4-66	TBUFF .....	4-152A
ISCALE? .....	4-68	TERM .....	4-153
LFREQ .....	4-70	TERM? .....	4-154
LFREQ? .....	4-71	TEST .....	4-155
LINE? .....	4-72	TIMER .....	4-157
LOCK .....	4-73	TIMER? .....	4-159
MATH .....	4-74	TONE .....	4-160
MATH? .....	4-77	TRIG .....	4-161
MCOUNT? .....	4-78	TRIG? .....	4-164
		? .....	4-165



# Chapter 4

# Command Reference

## Introduction

This chapter is composed of two main sections. The first section contains all of the HP 3457 commands listed in alphabetical order. The second section contains the BASIC language HP-IB commands that apply to the HP 3457. Before using this chapter, you should read about your particular measurement task in Chapter 3. There you will find an overview of the particular task and a summary of which commands to use.

The commands in this chapter are described using the following format:

**Command Name**

**Local/Remote Execution** A solid box means yes, an open box means no. In this example, the command can be executed from both local and remote.

**Command Description**

**Syntax Statement & Diagram** shows the command format.

**Parameters** describes parameter choices or ranges.

**Power-On Value** shows the parameter used when power is applied.

**Default Value** shows the parameter used if you do not specify a parameter.

**Important Points** contains special information about the command.

**Examples** show typical BASIC language programs or statements (HP 3457 at address 722). All examples will function when executed with the HP 3457 in the power-on state.


BEEP

■ Front Panel  
■ Remote

---

The BEEP command controls the HP 3457's beeper. When enabled, the beeper signals error situations with a 1 kHz beep.

**Syntax** BEEP control



**Parameters**

*control* The control parameter choices are:

control Parameter	Decimal Equiv.	Description
OFF	0	Disables the beeper
ON	1	Enables the beeper
ONCE	2	Beeps once then returns to previous mode (either enabled or disabled)

Power-on *control* = last programmed value.  
Default *control* = ONCE.

**Important Points**

- The HP 3457 signals the end of a power-on sequence with a 500 Hz tone. The BEEP command does not affect this tone.
- The HP 3457 stores the control value in non-volatile memory (the value is not lost when power is removed).

**Example**


```
OUTPUT 722: "BEEP OFF"          | DISABLES THE BEEPER
```


After executing this line, the HP 3457 does not beep when an error occurs.


Command Reference 4-23


## Reading a Syntax Diagram

The syntax diagrams show the most common form of command construction. They do not show every possible construction, especially from remote. The other possibilities not shown in the syntax diagrams are discussed under “Parameters” in this section.

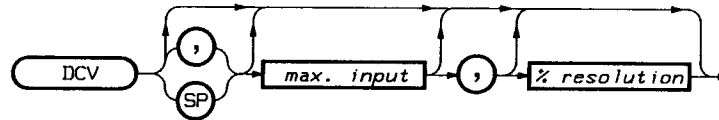
 The oblong shape contains the command header which must be entered exactly as shown (must be upper case).

 Circles contain either a space (SP) or comma which separate elements in the command string.

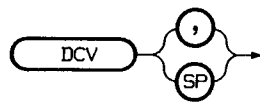
 Rectangles contain parameters which follow the command header. Each parameter is described in text below the syntax diagram. A line bypassing a rectangle indicates that the parameter has a default value.

 Lines and arrows indicate correct paths through the syntax diagram.

For example, the syntax diagram for the DCV command is:

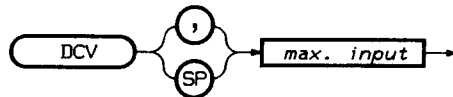


You can use the syntax diagram to construct a command string. For example, start with the command header followed by either a space or a comma:



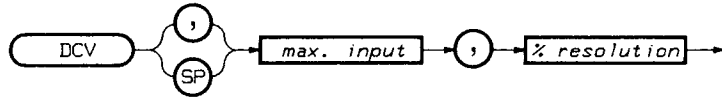
**DCV,**

Next, add the *max. input* parameter. For this example, use 7 volts:



**DCV,7**

Now add a comma and specify the *% resolution* parameter:



### **DCV,7,.001**

You can now execute the command (as indicated by the arrow on the right of the diagram).

Notice in the original DCV syntax diagram, there is a line bypassing each parameter. This means each parameter has a default value. The line around both parameters means you can default both. Refer to “Defaulting Parameters” below for more information.

# Language Conventions

In the power-on mode, the HP 3457 complies with “IEEE Standard 728-1982 Recommended Practice for Code and Format Conventions.”

## Sending Commands

The <CR> (carriage return), <LF> (line feed), or ; (semicolon) delimiters indicate the end of a message to the HP 3457. This is similar to setting the HP-IB EOI line true concurrent with the transmission of the last data byte. Any character(s) following the end of message delimiter, will not be processed until the command is executed. This means the HP 3457 always completes execution of the present command before accepting another command.

When you send a command using the standard format (e.g. OUTPUT 722;“TEST”), the computer sends <CR> <LF> (carriage return, line feed) on the data bus following the command. With its input buffer off, the HP 3457 processes the <CR> immediately but does not process the <LF> until the command is executed. This means that, because of the <LF>, the bus is held and you cannot regain control of the computer until the command is executed. You can prevent this by suppressing <CR> <LF> when sending the command. The example below shows how to use image specifiers (#, K) to suppress <CR> <LF> when sending the TEST command.

```
OUTPUT 722 USING “#,K”;“TEST;”
```

---

### NOTE

*In the above line, the # image specifier suppresses the <CR> <LF>. The K image specifier suppresses trailing or leading spaces and outputs the command in free-field format. Notice the semicolon following TEST. This indicates the end of the command to the HP 3457 and must be present when you suppress <CR> <LF>.*

---

Multiple commands separated by semicolons (;) may be used in one command string. For example:

```
OUTPUT 722;“DCV 3,.0001;NPLC 10;TRIG AUTO”
```

## Parameters

Numbers used as parameters can be in either integer, floating point, or exponential format. Numbers in floating point format, however, are rounded to the nearest integer if the command requires an integer. For example, TERM .4 is rounded down to TERM 0 (open), TERM .5 is rounded up to TERM 1 (front), and TERM 1.6 is rounded up to TERM 2 (rear).

From remote, you can replace any comma delimiter with a space. When a comma and space(s) are used together (e.g. OUTPUT 722;DCV 3 , .001"), the HP 3457 ignores the space(s) and executes the command as if the spaces did not exist. Delimiters for local operation are discussed fully in Chapter 2 under "Operating from the Front Panel."

### Defaulting Parameters

You default a parameter by omitting it or by replacing it with -1 (minus 1). For example, to specify 10 for the first parameter and default the second, send:

```
OUTPUT 722;"ACV 10"
```

or:

```
OUTPUT 722;"ACV 10,-1"
```

---

#### NOTE

*You cannot use -1 to default the second parameter in the SMATH command. If you specify -1, you will actually write -1 to a register.*

---

From remote only, you can use two commas to indicate a default value. For example, To specify 10 for the first parameter and default the second parameter, send:

```
OUTPUT 722;"ACV 10,,"
```

To default the first parameter and specify .01 for the second, send:

```
OUTPUT 722;"ACV ,,.01"
```

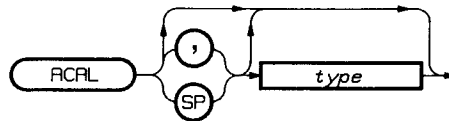
Notice in the above example, a space comes before the two commas. If you omit the space, you can default the first parameter and specify the second by sending:

```
OUTPUT 722;"ACV,,.01"
```



The ACAL (autocal) command instructs the HP 3457 to perform one or both of its automatic calibrations.

## Syntax *ACAL type*



## Parameters

*type* The *type* parameter choices are:

<i>type</i> Parameter	Decimal Equiv.	Description
ALL	1	Performs both of the following autocal
AC	2	Performs the AC flatness and AC offset autocal
OHMS	3	Performs the extended ohms and precharge autocal

Power-on *type* = none.

Default *type* = ALL.

## Important Points

- The AC autocal increases short term accuracy for AC or AC + DC voltage, and AC or AC + DC current measurements. The OHMS autocal increases short term accuracy of the 3G  $\Omega$  range for 2-wire and 4-wire ohms measurements.
- Always perform the OHMS autocal before making measurements on the 3 G $\Omega$  range. The OHMS autocal uses the presently selected input terminals (TERM command). Select the terminals you are going to use before performing the OHMS autocal.
- Always disconnect any input signals before you perform an autocal. If you leave an input signal connected to the HP 3457, it may adversely affect the autocal.
- The autocal constants are stored in non-volatile memory (remain intact when power is removed). That is, you do not necessarily need to perform autocal after power has been removed and re-applied.

## ACAL (cont)

- The AC autocal takes about 3 seconds. The OHMS autocal takes about 32 seconds. Both autocals take about 35 seconds.

### Examples

OUTPUT 722;"ACAL 1" ! RUNS BOTH AUTOCALS

The above example sends <CR> <LF> following the command which causes the HP-IB bus to be held (unless the input buffer is enabled) until the autocals are completed. If you want to regain control of the bus immediately, suppress the <CR> <LF> by sending:

OUTPUT 722 USING "#,K" ACAL 1;"

---

#### NOTE

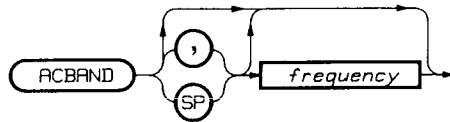
*In the above line, the # image specifier suppresses the <CR> <LF>. The K image specifier suppresses trailing or leading spaces and outputs the command in free-field format. Notice the semicolon following ACAL 1. This indicates the end of the command to the HP 3457 and must be present when you suppress <CR> <LF>.*

---



The ACBAND (AC bandwidth) command selects the slow or fast measurement mode for AC voltage, AC current, frequency, or period measurements.

**Syntax** ACBAND *frequency*



## Parameters

*frequency* You specify the *frequency* parameter as the expected frequency of the input signal. The HP 3457 then automatically selects the slow or fast mode as follows:

<i>frequency</i> Parameter (in Hz)	Description
< 400	Selects the slow mode
≥ 400	Selects the fast mode

Power-on *frequency* = selects the slow mode.  
 Default *frequency* = selects the slow mode.

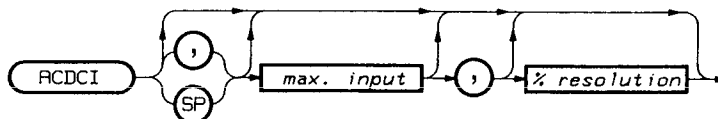
## Important Points

- The slow mode selects a long time constant for the input filter and a long delay time. Use this mode for measurements where the frequency is below 400 Hz. The fast mode selects a short time constant and a short delay time. Use this mode for measurements where the frequency is equal to or greater than 400 Hz. Table 3-15 shows the slow and fast mode delays for all functions and ranges.
- Since the fast mode has a short delay, it allows you to make a series of measurements faster than in the slow mode.
- If you are unsure of the input frequency, or if the frequency may dip below 400 Hz, use the slow mode. This takes slightly more time per measurement, but assures you of accurate measurements.

**Example** OUTPUT 722; "ACBAND 5000" ! SELECTS THE FAST MODE

The ACDCI (AC + DC current) command instructs the HP 3457 to measure the combined AC and DC current of the input signal. This command also allows you to specify the measurement range and resolution.

**Syntax** ACDCI *max. input*, *% resolution*



## Parameters

***max. input*** The *max. input* parameter selects one of three standard ranges or the autorange mode. To select a standard range, you specify the *max. input* as the input signal's maximum expected RMS amplitude. The HP 3457 then selects the correct range. The *max. input* possibilities are:

<i>max. input</i> Parameter	Selects Range	Full Scale Reading
-1 or AUTO	Autorange	
0 - .03	30 mA	32.5 mA
>.03 - .3	300 mA	325 mA
>.3 - 1	1 A	1.05 A

Power-on *max. input* = none.  
 Default *max. input* = AUTO.

***% resolution*** You specify the *% resolution* parameter as a percentage of the *max. input* parameter. The HP 3457 then multiplies *% resolution* times *max. input* to determine the measurement resolution.

For example, suppose your maximum expected input is 1 amp and you want 100  $\mu$ A of resolution. To determine *% resolution*, use the equation:

$$\% \text{ resolution} = (\text{actual resolution}/\text{maximum input}) \times 100$$

For this example, the equation evaluates to:

$$\% \text{ resolution} = (.0001/1) \times 100 = .0001 \times 100 = .01$$

## ACDCI (cont)

---

### NOTE

*When using autorange, the HP 3457 samples the input signal before each measurement and selects the correct range. The HP 3457 then multiplies the % resolution parameter times the full scale reading of the selected range. The result is the minimum resolution. The HP 3457 always gives you at least the minimum resolution and, in many cases, it gives you an additional digit of resolution.*

---

Power-on % resolution = none.

Default % resolution = determined by the integration time specified by the NPLC command.

### Important Points

- The power-on value for number of digits (NDIG) is 5. This masks one display digit. Set the number of digits to 6 to view the remaining digit.
- From the front panel, you select AC + DC current measurements using the shifted ACDCI key or by accessing the FUNC command from the alphabetic command directory. The shifted ACDCI key does not allow you to select any additional parameters. With the FUNC command, you can specify the measurement range and resolution.
- The HP 3457 changes the measurement resolution by changing the amount of time during which it samples the input signal (integration time). Both the % resolution parameter and the NPLC command affect the integration time. When you execute a function command (ACV, DCV, ACI, etc.) the HP 3457 compares the integration time specified by % resolution to that specified by the NPLC command. The HP 3457 then uses the parameter or command that designates the longest integration time (most resolution). Since the NPLC command's power-on value is 10 PLCs, you must lower the number of PLCs to get less resolution (this is shown in the following example). You can find more information on integration time and resolution in "The A/D Converter," Chapter 3.

## ACDCI (cont)

### Examples

```
10 OUTPUT 722;"NPLC .0005"      ! SETS PLCS TO MINIMUM
20 OUTPUT 722;"ACDCI .6,.167"   ! SELECTS AC+DC I, .6A MAX,.167% RESOLUTION
30 END
```

In the above program, line 10 allows *% resolution* in line 20 to control the resolution. The resolution specified by line 20 is  $.6A \times .00167 = .001A$ .

```
10 OUTPUT 722;"NPLC .0005"      ! SETS PLCS TO MINIMUM
20 OUTPUT 722;"ACDCI AUTO,.033"! SELECTS AC+DC I, AUTORANGE, .033% RESOLUTION
30 END
```

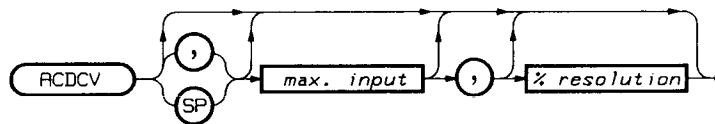
In the above program, line 10 allows *% resolution* in line 20 to control the resolution. In this example, the HP 3457 provides at least .033% resolution for full scale readings on whatever range autorange selects.

```
10 OUTPUT 722;"NPLC 100"       ! SETS PLCS TO MAXIMUM
20 OUTPUT 722;"ACDCI 1,.1"     ! SELECTS AC+DC I, 1A MAX,.1% RESOLUTION
30 END
```

In the above program, line 10 sets the number of PLCs to 100. This corresponds to maximum resolution and prevents *% resolution* in line 20 from affecting the measurement. The requested resolution from line 20 is  $1A \times .001 = .001A$ . However, because of line 10, the actual resolution is .000001A.

The ACDCV (AC + DC voltage) command instructs the HP 3457 to measure the combined AC and DC voltage of the input signal. It also allows you to specify the measurement range and resolution.

**Syntax** ACDCV *max. input*, % *resolution*



## Parameters

***max. input*** The *max. input* parameter selects one of five standard ranges or the autorange mode. To select a standard range, you specify the *max. input* as the input signal's maximum expected RMS amplitude. The *max. input* possibilities are:

<i>max. input</i> Parameter	Selects Range	Full Scale Reading
-1 or AUTO	Autorange	
0 - .03	30 mV	32.5 mV
>.03 - .3	300 mV	325 mV
>.3 - 3	3 V	3.25 V
>3 - 30	30 V	32.5 V
>30 - 300	300 V	303 V

Power-on *max. input* = none.  
 Default *max. input* = AUTO.

**% *resolution*** You specify the % *resolution* parameter as a percentage of the *max. input* parameter. The HP 3457 then multiplies % *resolution* times *max. input* to determine the measurement resolution.

For example, suppose your maximum expected input is 10V and you want 1mV of resolution. To determine % *resolution*, use the equation:

$$\% \text{ resolution} = (\text{actual resolution}/\text{maximum input}) \times 100$$

For this example, the equation evaluates to:

$$\% \text{ resolution} = (.001/10) \times 100 = .0001 \times 100 = .01$$

## ACDCV (cont)

---

### NOTE

*When using autorange, the HP 3457 samples the input signal before each measurement and selects the correct range. The HP 3457 then multiplies the % resolution parameter times the full scale reading of the selected range. The result is the minimum resolution. The HP 3457 always gives you at least the minimum resolution and, in many cases, it gives you an additional digit of resolution.*

---

Power-on % resolution = none.

Default % resolution = determined by the integration time specified by the NPLC command.

### Important Points

- The power-on value for number of digits (NDIG) is 5. This masks one display digit. Set the number of digits to 6 to view the remaining digit.
- From the front panel, you select AC + DC voltage measurements using the shifted ACDCV key or by accessing the FUNC command from the alphabetic command directory. The shifted ACDCV key does not allow you to select any additional parameters. With the FUNC command, you can specify the measurement range and resolution.
- The HP 3457 changes the measurement resolution by changing the amount of time during which it samples the input signal (integration time). Both the % resolution parameter and the NPLC command affect the integration time. When you execute a function command (ACV, DCV, ACI, etc.) the HP 3457 compares the integration time specified by % resolution to that specified by the NPLC command. The HP 3457 then uses the parameter or command that designates the longest integration time (most resolution). Since the NPLC command's power-on value is 10 PLCs, you must lower the number of PLCs to get less resolution (this is shown in the following example). You can find more information on integration time and resolution in "The A/D Converter," Chapter 3.

## ACDCV (cont)

### Examples

```
10 OUTPUT 722;"NPLC .0005"      ! SETS PLCS TO MINIMUM
20 OUTPUT 722;"ACDCV 6,.0167"  ! SELECTS AC+DC V, 6V MAX,.0167% RESOLUTION
30 END
```

In the above program, line 10 allows *% resolution* in line 20 to control the resolution. The resolution specified by line 20 is  $6V \times .000167 = .001V$ .

```
10 OUTPUT 722;"NPLC .0005"      ! SETS PLCS TO MINIMUM
20 OUTPUT 722;"ACDCV AUTO,.033" ! SELECTS AC+DC V, AUTORANGE, .033% RESOLUTION
30 END
```

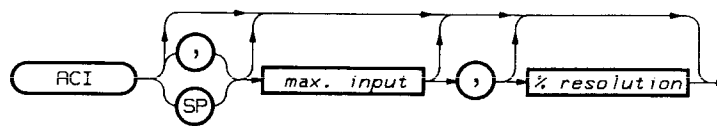
In the above program, line 10 allows *% resolution* in line 20 to control the resolution. In this example, the HP 3457 provides at least .033% resolution for full scale readings on whatever range autorange selects.

```
10 OUTPUT 722;"NPLC 100"       ! SETS PLCS TO MAXIMUM
20 OUTPUT 722;"ACDCV 1,.1"     ! SELECTS AC+DC V, 1V MAX,.1% RESOLUTION
30 END
```

In the above program, line 10 sets the number of PLCs to 100. This corresponds to maximum resolution and prevents *% resolution* in line 20 from affecting the measurement. The requested resolution from line 20 is  $1V \times .001 = .001V$ . However, because of line 10, the actual resolution is .000001V.

The ACI (AC current) command instructs the HP 3457 to measure AC current. It also allows you to specify the measurement range and resolution.

**Syntax** *ACI max. input, % resolution*



## Parameters

***max. input*** The *max. input* parameter selects one of three standard ranges or the autorange mode. To select a standard range, you specify the *max. input* as the input signal's maximum expected RMS amplitude. The HP 3457 then selects the correct range. The *max. input* possibilities are:

<i>max. input</i> Parameter	Selects Range	Full Scale Reading
-1 or AUTO	Autorange	
0 - .03	30 mA	32.5 mA
>.03 - .3	300 mA	325 mA
>.3 - 1	1 A	1.05 A

Power-on *max. input* = none.

Default *max. input* = AUTO.

***% resolution*** You specify the *% resolution* parameter as a percentage of the *max. input* parameter. The HP 3457 then multiplies *% resolution* times max. input to determine the measurement resolution.

For example, suppose your maximum expected input is 1 amp and you want 100  $\mu$ A of resolution. To determine *% resolution*, use the equation:

$$\% \text{ resolution} = (\text{actual resolution}/\text{maximum input}) \times 100$$



## ACI (cont)

For this example, the equation evaluates to:

$$\% \text{ resolution} = (.0001/1) \times 100 = .0001 \times 100 = .01$$

---

### NOTE

*When using autorange, the HP 3457 samples the input signal before each measurement and selects the correct range. The HP 3457 then multiplies the % resolution parameter times the full scale reading of the selected range. The result is the minimum resolution. The HP 3457 always gives you at least the minimum resolution and, in many cases, it gives you an additional digit of resolution.*

---

Power-on % resolution = none.

Default % resolution = determined by the integration time specified by the NPLC command.

### Important Points

- The power-on value for number of digits (NDIG) is 5. This masks one display digit. Set the number of digits to 6 to view the remaining digit.
- From the front panel, you select AC current measurements using the ACI key or by accessing the FUNC command from the alphabetic command directory. The ACI key does not allow you to select any additional parameters. With the FUNC command, you can specify the measurement range and resolution.
- The HP 3457 changes the measurement resolution by changing the amount of time during which it samples the input signal (integration time). Both the % resolution parameter and the NPLC command affect the integration time. When you execute a function command (ACV, DCV, ACI, etc.) the HP 3457 compares the integration time specified by % resolution to that specified by the NPLC command. The HP 3457 then uses the parameter or command that designates the longest integration time (most resolution). Since the NPLC command's power-on value is 10 PLCs, you must lower the number of PLCs to get less resolution (this is shown in the following example). You can find more information on integration time and resolution in "The A/D Converter," Chapter 3.

## ACI (cont)

### Examples

```
10 OUTPUT 722;"NPLC .0005"      ! SETS PLCS TO MINIMUM
20 OUTPUT 722;"ACI .6,.167"     ! SELECTS AC I, .6A MAX,.167% RESOLUTION
30 END
```

In the above program, line 10 allows *% resolution* in line 20 to control the resolution. The resolution specified by line 20 is  $.6A \times .00167 = .001A$ .

```
10 OUTPUT 722;"NPLC .0005"      ! SETS PLCS TO MINIMUM
20 OUTPUT 722;"ACI AUTO,.033"   ! SELECTS AC I, AUTORANGE, .033% RESOLUTION
30 END
```

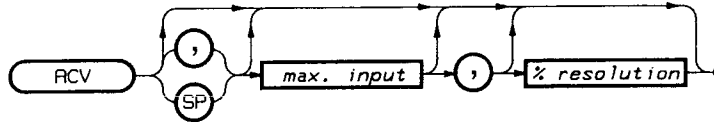
In the above program, line 10 allows *% resolution* in line 20 to control the resolution. In this example, the HP 3457 provides at least .033% resolution for full scale readings on whatever range autorange selects.

```
10 OUTPUT 722;"NPLC 100"       ! SETS PLCS TO MAXIMUM
20 OUTPUT 722;"ACI 1,.1"       ! SELECTS AC I, 1A MAX,.1% RESOLUTION
30 END
```

In the above program, line 10 sets the number of PLCs to 100. This corresponds to maximum resolution and prevents *% resolution* in line 20 from affecting the measurement. The requested resolution from line 20 is  $1A \times .001 = .001A$ . However, because of line 10, the actual resolution is .000001A.

The ACV (AC voltage) command instructs the HP 3457 to measure AC voltage. It also allows you to specify the measurement range and resolution.

**Syntax** *ACV max.input, % resolution*



## Parameters

***max. input*** The *max. input* parameter selects one of five standard ranges or the autorange mode. To select a standard range, you specify the *max. input* as the input signal's maximum expected RMS amplitude. The *max. input* possibilities are:

<i>max. input</i> Parameter	Selects Range	Full Scale Reading
-1 or AUTO	Autorange	
0 - .03	30 mV	32.5 mV
>.03 - .3	300 mV	325 mV
>.3 - 3	3 V	3.25 V
>3 - 30	30 V	32.5 V
>30 - 300	300 V	303 V

Power-on *max. input* = none.  
 Default *max. input* = AUTO.

***% resolution*** You specify the *% resolution* parameter as a percentage of the *max. input* parameter. The HP 3457 then multiplies *% resolution* times *max. input* to determine the measurement resolution.

For example, suppose your maximum expected input is 10V and you want 1mV of resolution. To determine *% resolution*, use the equation:

$$\% \text{ resolution} = (\text{actual resolution}/\text{maximum input}) \times 100$$

For this example, the equation evaluates to:

$$\% \text{ resolution} = (.001/10) \times 100 = .0001 \times 100 = .01$$

## ACV (cont)

---

### NOTE

*When using autorange, the HP 3457 samples the input signal before each measurement and selects the correct range. The HP 3457 then multiplies the % resolution parameter times the full scale reading of the selected range. The result is the minimum resolution. The HP 3457 always gives you at least the minimum resolution and, in many cases, it gives you an additional digit of resolution.*

---

Power-on % resolution = none.

Default % resolution = determined by the integration time specified by the NPLC command.

### Important Points

- The power-on value for number of digits (NDIG) is 5. This masks one display digit. Set the number of digits to 6 to view the remaining digit.
- From the front panel, you select AC + DC voltage measurements using the shifted ACDCV key or by accessing the FUNC command from the alphabetic command directory. The shifted ACDCV key does not allow you to select any additional parameters. With the FUNC command, you can specify the measurement range and resolution.
- The HP 3457 changes the measurement resolution by changing the amount of time during which it samples the input signal (integration time). Both the % resolution parameter and the NPLC command affect the integration time. When you execute a function command (ACV,DCV,ACI, etc.) the HP 3457 compares the integration time specified by % resolution to that specified by the NPLC command. The HP 3457 then uses the parameter or command that designates the longest integration time (most resolution). Since the NPLC command's power-on value is 10 PLCs, you must lower the number of PLCs to get less resolution (this is shown in the following example). You can find more information on integration time and resolution in "The A/D Converter," Chapter 3.

## ACV (cont)

### Examples

```
10 OUTPUT 722;"NPLC .0005"      ! SETS PLCS TO MINIMUM
20 OUTPUT 722;"ACV 6,.0167"    ! SELECTS ACV, 6V MAX,.0167% RESOLUTION
30 END
```

In the above program, line 10 allows *% resolution* in line 20 to control the resolution. The resolution specified by line 20 is  $6V \times .000167 = .001V$ .

```
10 OUTPUT 722;"NPLC .0005"      ! SETS PLCS TO MINIMUM
20 OUTPUT 722;"ACV AUTO,.033"   ! SELECTS ACV, AUTORANGE, .033% RESOLUTION
30 END
```

In the above program, line 10 allows *% resolution* in line 20 to control the resolution. In this example, the HP 3457 provides at least .033% resolution for full scale readings on whatever range autorange selects.

```
10 OUTPUT 722;"NPLC 100"       ! SETS PLCS TO MAXIMUM
20 OUTPUT 722;"ACV 1,.1"       ! SELECTS ACV, 1V MAX,.1% RESOLUTION
30 END
```

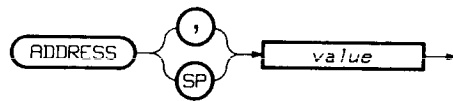
In the above program, line 10 sets the number of PLCs to 100. This corresponds to maximum resolution and prevents *% resolution* in line 20 from affecting the measurement. The requested resolution from line 20 is  $1V \times .001 = .001V$ . However, because of line 10, the actual resolution is .000001V.

# ADDRESS

- Front Panel
- Remote

The ADDRESS command sets the HP 3457's HP-IB address. The HP 3457 stores the address in non-volatile memory (the address is not lost when power is removed).

**Syntax** ADDRESS *value*



## Parameters

*value* The *value* parameter choices are:

<i>value</i> Parameter	ASCII Code Character	
	Talk	Listen
0	@	SP
1	A	!
2	B	"
3	C	#
4	D	\$
5	E	%
6	F	&
7	G	'
8	H	(
9	I	)
10	J	*
11	K	+
12	L	,
13	M	-
14	N	.
15	O	/

<i>value</i> Parameter	ASCII Code Character	
	Talk	Listen
16	P	0
17	Q	1
18	R	2
19	S	3
20	T	4
21	U	5
22	V	6
23	W	7
24	X	8
25	Y	9
26	Z	:
27	[	;
28	\	<
29	]	=
30	~	^
31	Talk Only Mode	

Power-on *value* = previously stored address (factory setting = 22).  
Default *value* = none; parameter required.

## ADDRESS (cont)

### Important Points

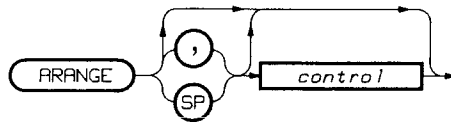
- Address 31 sets the HP 3457 to the Talk Only mode. In this mode, the HP 3457 outputs directly to an HP-IB printer without a controller on the bus. Address 31, however, is not a valid HP-IB address with a controller on the bus.
- If the HP 3457 detects a RAM failure it sets the address to 22.
- An example showing how to change the address is under “Changing the HP-IB Address” in Chapter 2.

# ARRANGE

- Front Panel
- Remote

The ARRANGE (autorange) command enables or disables the autorange function.

**Syntax** ARRANGE *control*



## Parameters

*control* The *control* parameter choices are:

<i>control</i> Parameter	Decimal Equiv.	Description
OFF	0	Disables autorange algorithm
ON	1	Enables autorange algorithm

Power-on *control* = ON.

Default *control* = ON.

## Important Points

- With autorange enabled, the HP 3457 samples the input signal before each measurement and selects the appropriate range.
- Refer to the appropriate function command (ACV, DCV, ACDCI, etc.) for a listing of the possible ranges for that function.
- If you have manually selected a range and then enable autorange, it is possible that autorange will select a different range. For example, if you are measuring 295 mVDC on the 300 mVDC range (manually selected) and then enable autorange, autorange selects the 3 VDC range.

**Example** OUTPUT 722;"ARRANGE ON" ! ENABLES AUTORANGE



When a hardware error is detected, the HP 3457 sets a bit in the auxiliary error register. The AUXERR? (auxiliary error) command returns a number representing these set bits and clears the register. The returned number is the weighted sum of all set bits.

## Syntax AUXERR?

AUXERR? →

## Auxiliary Error Conditions

The auxiliary error conditions and their weighted values are:

Weighted Value	Bit Number	Description
1	0	Isolation error during operation in any mode (self-test, autocal, measurements, etc.)
2	1	Slave processor self-test failure
4	2	Isolation self-test failure
8	3	Integrator convergence error
16	4	Front end zero measurement error
32	5	Current source, gain selection, input divider failure
64	6	Amps self-test failure
128	7	AC amplifier's DC offset test failure
256	8	AC flatness check
512	9	Ohms precharge failure during autocal
1024	10	32k ROM checksum failure
2048	11	8k ROM checksum failure
4096	12	Non-volatile RAM failure
8192	13	Volatile RAM failure
16384	14	Calibration RAM protection failure

## Important Points

- The auxiliary error register indicates hardware related errors. If one or more bits are set, your HP 3457 needs repair or calibration.
- The AUXERR? command returns a 0 if no error bits are set.
- If any bit in the auxiliary error register is set, the HP 3457 sets bit 0 (hardware error) in the error register. Reading the auxiliary error register does not clear bit 0 in the error register. You must read the error register (ERR? command) to clear it.

## AUXERR? (cont)

- If you execute the AUXERR? command from the HP 3457's front panel, the weighted sum goes to the display. If you execute AUXERR? from the controller, the weighted sum goes to the HP 3457's output buffer in ASCII format. After the weighted sum is sent to the output buffer, the output format returns to the previously specified type (SINT, DINT, SREAL, or ASCII).
- You cannot mask any bits in the auxiliary error register.

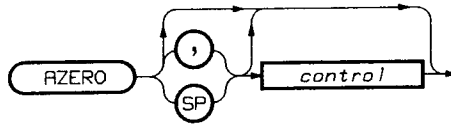
### Example

```
10 OUTPUT 722;"AUXERR?"      ! READS THE AUXILIARY ERROR REGISTER
20 ENTER 722;A                ! ENTERS WEIGHTED SUM INTO VARIABLE A
30 DISP A                     ! DISPLAYS THE WEIGHTED SUM
40 END
```

As an example, assume the AUXERR? command returns the weighted sum 513. This means that the errors with weighted values of 1 (isolation error) and 512 (ohms precharge failure) have occurred.

The AZERO (autozero) command enables or disables the autozero function.

## Syntax *AZERO control*



## Parameters

*control* The *control* parameter choices are:

<i>control</i> Parameter	Decimal Equiv.	Description
OFF	0	Zero measurement is updated once, then only after a function or range change
ON	1	Zero measurement is updated after every measurement
ONCE	2	Zero measurement is updated once, then only after a function or range change

Power-on *control* = ON.

Default *control* = ON.

## Important Points

- When autozero is ON, the HP 3457 makes a zero measurement (measurement with the input disabled) following every measured reading and subtracts the zero measurement from the reading. This doubles the time required per measurement.
- When autozero is OFF, the HP 3457 makes one zero measurement and subtracts this from all subsequent measurements. A new zero measurement is made whenever the function or range is changed. Notice that the control parameters OFF and ONCE have the same effect.
- The display annunciator “AZOFF” is on whenever autozero is off.

**Example** OUTPUT 722;“AZERO OFF” ! DISABLES AUTOZERO

This line makes a single autozero measurement and then disables autozero until the measurement function or range changes.

# AZERO?

- Front Panel
- Remote

The AZERO? (autozero?) command returns a number indicating the autozero mode: 1 = ON, 0 = OFF or ONCE.

## Syntax AZERO?

AZERO?

## Important Points

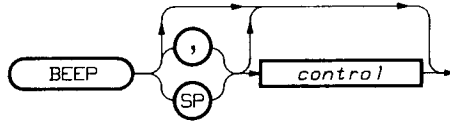
- From the HP 3457's front panel, you execute the AZERO? command by accessing the AZERO command from the alphabetic command directory and appending a question mark.
- If you execute AZERO? from the HP 3457's front panel, the result goes to the display. If you execute AZERO? from the controller, the result goes to the HP 3457's output buffer in ASCII format after which the output format returns to the previously specified type (SINT, DINT, SREAL, or ASCII).

## Example

```
10 OUTPUT 722;"AZERO?"      ! RETURNS AUTO ZERO RESPONSE
20 ENTER 722;A              ! ENTERS RESPONSE INTO VARIABLE A
30 DISP A                   ! DISPLAYS RESPONSE
40 END
```

The BEEP command controls the HP 3457's beeper. When enabled, the beeper signals error situations with a 1 kHz beep.

**Syntax** BEEP *control*



## Parameters

*control* The *control* parameter choices are:

<i>control</i> Parameter	Decimal Equiv.	Description
OFF	0	Disables the beeper
ON	1	Enables the beeper
ONCE	2	Beeps once then returns to previous mode (either enabled or disabled)

Power-on *control* = last programmed value.

Default *control* = ONCE.

## Important Points

- The HP 3457 signals the end of a power-on sequence with a 500 Hz tone. The BEEP command does not affect this tone.
- The HP 3457 stores the control value in non-volatile memory (the value is not lost when power is removed).

## Example

OUTPUT 722;"BEEP OFF" ! DISABLES THE BEEPER

After executing this line, the HP 3457 does not beep when an error occurs.

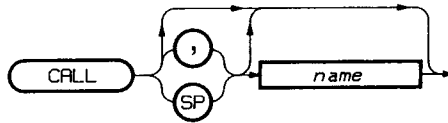
# CAL

- Front Panel
  - Remote
- 

This is a service related command. Refer to the HP 3457 service manual for details.

The CALL command executes a previously stored subprogram.

**Syntax** CALL *name*



## Parameters

***name*** The *name* parameter is a decimal number from 0 to 19 that selects the subprogram memory location.

Power-on *name* = none.  
Default *name* = 0.

## Important Points

- You store a subprogram using the SUB command.
- The HP 3457 sets status bit 0 after executing a stored subprogram.

## Examples

OUTPUT 722;"CALL 2" ! RUNS SUBPROGRAM IN MEMORY LOCATION 2

The above example sends <CR> <LF> following the command which causes the HP-IB bus to be held (unless the input buffer is enabled) until subprogram execution is completed. If you want to regain control of the bus immediately, suppress the <CR> <LF> by sending:

OUTPUT 722 USING "#,K";"CALL 2;"

---

### NOTE

*In the above line, the # image specifier suppresses the <CR> <LF>. The K image specifier suppresses trailing or leading spaces and outputs the command in free-field format. Notice the semicolon following CALL 2. This indicates the end of the command to the HP 3457 and must be present when you suppress <CR> <LF>.*

---

# CALNUM?

- Front Panel
- Remote

The CALNUM? (calibration number?) command returns a decimal number indicating the number of times your HP 3457 has been calibrated. By routinely monitoring the calibration number, you can determine when calibrations are performed and whether or not an unauthorized calibration has been done.

## Syntax CALNUM?

CALNUM? →

## Important Points

- Your HP 3457 was calibrated before it left the factory. When you receive your HP 3457, read the calibration number to determine its initial value.
- The calibration number is stored in non-volatile memory (not lost when power is removed).
- The calibration number increments by one for each instrument point calibrated. A complete calibration increments the calibration number by several counts. The calibration number increments up to a maximum of 32767 after which it wraps-around to 0.
- Auto-calibration does not affect the calibration number.
- When you execute the CALNUM? command from the HP 3457's front panel, the response goes to the display. When executed from the controller, the response goes to the HP 3457's output buffer in ASCII format. After executing the CALNUM? command, the output format returns to the previously specified type (SINT, DINT, SREAL, or ASCII).

## Example

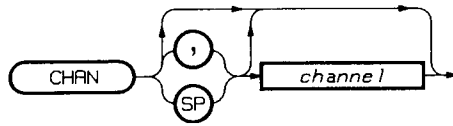
```
10 OUTPUT 722;"CALNUM?"           ! READS CALIBRATION NUMBER
20 ENTER 722;A                     ! ENTERS RESPONSE INTO COMPUTER'S A VARIABLE
30 DISP A                           ! DISPLAYS RESPONSE
40 END
```



The CHAN (channel) command allows you to select a plug-in card input channel for measurements.

## Syntax

CHAN *channel*



## Parameters

***channel*** The *channel* parameter is the number of the channel you want to use for measurements. The choices are:

For the HP 44491:

<i>channel</i> Parameter	Description
0 - 7	2-wire input channels
8 and 9	Current input channels
10 - 13	4-wire input channels

For the HP 44492:

<i>channel</i> Parameter	Description
0 - 9	2-wire input channels

Power-on *channel* = none (no channel selected).

Default *channel* = 0.

## Important Points

- To make a measurement on a plug-in card input channel, you must specify the plug-in card as the input source using the TERM command.
- The CHAN command opens any previously selected scan list input channel. However, the scan list itself remains intact. If a specified SADV event occurs after a CHAN command, an advance is made to the next channel in the scan list.

## CHAN (cont)

- If you execute the CHAN command with no plug-in card in the HP 3457's rear slot, you'll get the BAD HEADER error.
- Refer to "CHAN Command" listed under your particular plug-in card in Chapter 5 for additional "Important Points."

### Examples

```
10 OUTPUT 722;"RESET"           ! RESETS THE HP 3457
20 OUTPUT 722;"TERM REAR"       ! SELECTS THE INPUT SOURCE
30 OUTPUT 722;"CHAN 2"         ! SELECTS CHANNEL 2
40 END
```

```
10 OUTPUT 722;"PRESET"         ! PRESETS THE HP 3457
20 OUTPUT 722;"TERM REAR"       ! SELECTS THE INPUT SOURCE
30 OUTPUT 722;"CHAN 2"         ! SELECTS CHANNEL 2
40 ENTER 722;A                 ! TRIGGERS & ENTERS READING
50 DISP A                      ! DISPLAYS READING
60 OUTPUT 722;"CHAN 3"         ! OPENS CHANNEL . 2, CLOSES CHANNEL . 3
70 ENTER 722;A                 ! TRIGGERS & ENTERS READING
80 DISP A                      ! DISPLAYS READING
90 END
```

The CHAN? (channel?) command returns the channel number of any presently selected plug-in card input channel.

## Syntax CHAN?

CHAN? →

## Important Points

- From the HP 3457's front panel, you execute the CHAN? command by accessing the CHAN command from the alphabetic command directory and appending a question mark.
- When you execute the CHAN? command from the HP 3457's front panel, the response goes to the display. When executed from the controller, the response goes to the HP 3457's output buffer in ASCII format. After executing the CHAN? command, the output format returns to the previously specified type (SINT, DINT, SREAL, or ASCII).
- If no channel is selected, the CHAN? command returns -1 (minus 1).
- The CHAN? command does not reveal the state of an actuator channel (channel 8 or 9 on an HP 44491 card) unless that channel was closed by a scan list. The CHAN? command does reveal the state of channel 8 or 9 when selected as a current input.

## Example

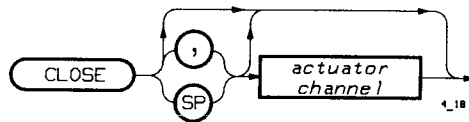
```
10 OUTPUT 722;"CHAN?"           ! RETURNS PRESENT CHANNEL NUMBER
20 ENTER 722;A                   ! PUTS RESPONSE IN COMPUTER'S A VARIABLE
30 DISP A                         ! DISPLAYS RESPONSE
40 END
```

# CLOSE

- Front Panel
- Remote

The CLOSE command closes actuator channel 8 or 9 on the HP 44491 plug-in card.

**Syntax** CLOSE *actuator channel*



## Parameters

***actuator channel*** You specify the *actuator channel* parameter as the number of the channel you want to close (8 or 9).

Power-on *actuator channel* = none (both channels open).  
Default *actuator channel* = 8.

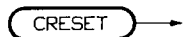
## Important Points

- On channels 8 and 9 there are separate current input relays and actuator output relays. If a current input relay is closed and you execute the CLOSE command on the same channel, the actuator closes then the current relay opens. The CLOSE command does not affect the present state of channels 0-7 or 10-13.
- When power is applied, the HP 3457 performs a card reset which opens actuator channels 8 and 9 on the HP 44491.
- You do not need to specify the HP 44491 as the input source (TERM command) to close or open an actuator.
- If you execute the CLOSE command without a plug-in card in the HP 3457's rear slot, you'll get the BAD HEADER error.

**Example** OUTPUT 722;"CLOSE 8" ! CLOSES THE CHANNEL 8 ACTUATOR

The CRESET (card reset) command opens all channels on a plug-in card without changing the HP 3457's configuration.

## Syntax CRESET



## Important Points

- The HP 3457 performs a card reset whenever you apply power or when you execute the RESET command.
- The CRESET command opens any channel closed in a scan list. However, the CRESET command leaves the scan list intact and retains the present position in the list. The CRESET command executes a scan advance hold (SADV HOLD), stopping any scan sequence. If, for example, you execute a single scan advance after a card reset, an advance occurs to the next channel in the scan list.
- If you issue the CRESET command without a plug-in card in the HP 3457's rear slot, you'll get the BAD HEADER error.

## Example

OUTPUT 722;"CRESET"

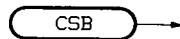
! RESETS THE CARD IN THE REAR SLOT

# CSB

- Front Panel
  - Remote
- 

The CSB (clear status byte) command clears (sets to 0) all bits in the status register.

## Syntax CSB



## Important Points

- If an event that set a bit in the status register is still in effect, the bit will be immediately set again after you send the CSB command.
- When you clear bit 6 (service requested) the HP 3457 sets the HP-IB SRQ line false.

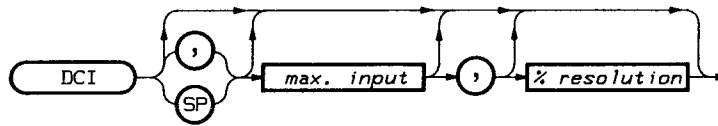
## Example

OUTPUT 722;"CSB"

! CLEARS THE STATUS REGISTER

The DCI (DC current) command instructs the HP 3457 to measure DC current. It also allows you to specify the measurement range and resolution.

**Syntax** DCI *max. input*, *% resolution*



## Parameters

***max. input*** The *max. input* parameter selects one of five standard ranges or the autorange mode. To select a standard range, you specify the *max. input* as the input signal's expected peak amplitude. The HP 3457 then selects the correct range.

To select the autorange mode, you specify AUTO or default the *max. input* parameter. In the autorange mode, the HP 3457 samples the input signal before each measurement and selects the appropriate range.

The *max. input* parameter choices are:

<i>max. input</i> Parameter	Selects Range	Full Scale Reading
-1 or AUTO	Autorange	
0 - .0003	300 $\mu$ A	303 $\mu$ A
>.0003 - .003	3 mA	3.03 mA
>.003 - .03	30 mA	30.3 mA
>.03 - .3	300 mA	303 mA
>.3 - 1.5	1.5 A	1.5 A

Power-on *max. input* = none.

Default *max. input* = AUTO.

***% resolution*** You specify the *% resolution* parameter as a percentage of the *max. input* parameter. The HP 3457 then multiplies *% resolution* times *max. input* to determine the measurement's resolution.

For example, suppose your maximum expected input is 1 amp and you want 100  $\mu$ A of resolution. To determine *% resolution*, use the equation:

## DCI (cont)

$$\% \text{ resolution} = (\text{actual resolution}/\text{maximum input}) \times 100$$

For this example, the equation evaluates to:

$$\% \text{ resolution} = (.0001/1) \times 100 = .0001 \times 100 = .01$$

---

### NOTE

*When using autorange, the HP 3457 multiplies the % resolution parameter times the full scale reading of the selected range. The result is the minimum resolution. The HP 3457 always gives you at least the minimum resolution and, in many cases, it gives you an additional digit of resolution.*

---

Power-on % resolution = none.

Default % resolution = determined by the integration time specified by the NPLC command (power-on NPLC = 10).

### Important Points

- The power-on value for number of digits (NDIG) is 5. This masks one display digit. Set the number of digits to 6 to view the remaining digit.
- From the front panel, you select DC current measurements using the DCI key or by accessing the FUNC command from the alphabetic command directory. The DCI key does not allow you to select any additional parameters. With the FUNC command, you can specify the measurement range and resolution.
- The HP 3457 changes the measurement resolution by changing the amount of time during which it samples the input signal (integration time). Both the % resolution parameter and the NPLC command affect the integration time. When you execute a function command (ACV, DCV, ACI, etc.) the HP 3457 compares the integration time specified by % resolution to that specified by the NPLC command. The HP 3457 then uses the parameter or command that designates the longest integration time (most resolution). Since the NPLC command's power-on value is 10 PLCs, you must lower the number of PLCs to get less resolution (this is shown in the following example). You can find more information on integration time and resolution under "The A/D Converter" in Chapter 3.



## DCI (cont)

### Examples

```
10 OUTPUT 722;"NPLC .0005"      ! SETS PLCS TO MINIMUM
20 OUTPUT 722;"DCI .6,.167"     ! SELECTS DC CURRENT, .6A MAX,.167% RESOLUTION.
30 END
```

In the above program, line 10 allows *% resolution* in line 20 to control the resolution. The resolution specified by line 20 is  $.6A \times .00167 = .001A$ .

```
10 OUTPUT 722;"NPLC .0005"      ! SETS PLCS TO MINIMUM
20 OUTPUT 722;"DCI AUTO,.033"   ! SELECTS I, AUTORANGE, .033% RESOLUTION
30 END
```

In the above program, line 10 allows *% resolution* in line 20 to control the resolution. In this example, the HP 3457 provides at least .033% resolution for full scale readings on whatever range autorange selects.

```
10 OUTPUT 722;"NPLC 100"       ! SETS PLCS TO MAXIMUM
20 OUTPUT 722;"DCI 1,.1"       ! SELECTS DC CURRENT, 1A MAX,.1% RESOLUTION.
30 END
```

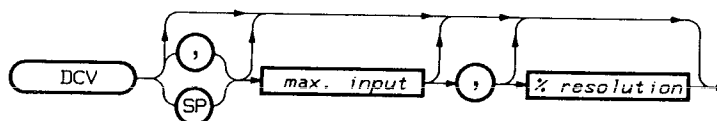
In the above program, line 10 sets the number of PLCs to 100. This corresponds to maximum resolution and prevents *% resolution* in line 20 from affecting the measurement. The requested resolution from line 20 is  $1A \times .001 = .001A$ . However, because of line 10, the actual resolution is .000001A.

# DCV

- Front Panel
- Remote

The DCV (DC voltage) command instructs the HP 3457 to measure DC voltage. It also allows you to specify the measurement range and resolution.

**Syntax** DCV *max. input*, *% resolution*



## Parameters

***max. input*** The *max. input* parameter selects one of five standard ranges or the autorange mode. To select a standard range, you specify the *max. input* as the input signal's expected peak amplitude. The HP 3457 then selects the correct range.

To select the autorange mode, you specify AUTO or default the *max. input* parameter. In the autorange mode, the HP 3457 samples the input signal before each measurement and selects the appropriate range.

The *max. input* parameter choices are:

<i>max. input</i> Parameter	Selects Range	Full Scale Reading
-1 or AUTO	Autorange	
0 - .03	30 mV	30.3 mV
>.03 - .3	300 mV	303 mV
>.3 - 3	3 V	3.03 V
>3 - 30	30 V	30.3 V
>30 - 300	300 V	303 V

Power-on *max. input* = AUTO.

Default *max. input* = AUTO.

***% resolution*** You specify the *% resolution* parameter as a percentage of the *max. input* parameter. The HP 3457 then multiplies *% resolution* times *max. input* to determine the measurement's resolution.

## DCV (cont)

For example, suppose your maximum expected input is 10V and you want 1mV of resolution. To determine *% resolution*, use the equation:

$$\% \text{ resolution} = (\text{actual resolution}/\text{maximum input}) \times 100$$

For this example, the equation evaluates to:

$$\% \text{ resolution} = (.001/10) \times 100 = .0001 \times 100 = .01$$

---

### NOTE

*When using autorange, the HP 3457 multiplies the % resolution parameter times the full scale reading of the selected range. The result is the minimum resolution. The HP 3457 always gives you at least the minimum resolution and, in many cases, it gives you an additional digit of resolution.*

---

Power-on *% resolution* = determined by the integration time specified by the NPLC command.

Default *% resolution* = determined by the integration time specified by the NPLC command.

## Important Points

- The power-on value for number of digits (NDIG) is 5. This masks one display digit. Set the number of digits to 6 to view the remaining digit.
- From the front panel, you select DC voltage measurements using the DCV key or by accessing the FUNC command from the alphabetic command directory. The DCV key does not allow you to select any additional parameters. With the FUNC command, you can specify the measurement range and resolution.
- The HP 3457 changes the measurement resolution by changing the amount of time during which it samples the input signal (integration time). Both the *% resolution* parameter and the NPLC command affect the integration time. When you execute a function command (ACV, DCV, ACI, etc.) the HP 3457 compares the integration time specified by *% resolution* to that specified by the NPLC command. The HP 3457 then uses the parameter or command that designates the longest integration time (most resolution). Since the NPLC command's power-on value is 10 PLCs, you must lower the number of PLCs to get less resolution (this is shown in the following example). You can find more information on integration time and resolution under "The A/D Converter" in Chapter 3.

## DCV (cont)

### Examples

```
10 OUTPUT 722;"NPLC .0005"      ! SETS PLCS TO MINIMUM
20 OUTPUT 722;"DCV 6,.0167"     ! SELECTS DC VOLTS, 6V MAX,.0167% RESOLUTION.
30 END
```

In the above program, line 10 allows *% resolution* in line 20 to control the resolution. The resolution specified by line 20 is  $6V \times .000167 = .001V$ .

```
10 OUTPUT 722;"NPLC .0005"      ! SETS PLCS TO MINIMUM
20 OUTPUT 722;"DCV AUTO,.033"   ! SELECTS DC VOLTS, AUTORANGE, .033% RESOLUTION
30 END
```

In the above program, line 10 allows *% resolution* in line 20 to control the resolution. In this example, the HP 3457 provides at least .033% resolution for full scale readings on whatever range autorange selects.

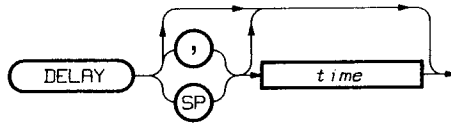
```
10 OUTPUT 722;"NPLC 100"       ! SETS PLCS TO MAXIMUM
20 OUTPUT 722;"DCV 1,.1"       ! SELECTS DC VOLTS, 1V MAX,.1% RESOLUTION.
30 END
```

In the above program, line 10 sets the number of PLCs to 100. This corresponds to maximum resolution and prevents *% resolution* in line 20 from affecting the measurement. The requested resolution from line 20 is  $1V \times .001 = .001V$ . However, because of line 10, the actual resolution is .000001V.

The DELAY command allows you to specify a time interval that is inserted before a measurement. If you are using the DELAY command and the TIMER parameter in the NRDGS command, the delay is inserted between the trigger event and the first measurement. If you are not using the TIMER parameter, the delay is inserted between the sample event and the first measurement. A discussion of the various events can be found under “Triggering” in Chapter 3.

## Syntax

DELAY *time*



## Parameters

*time* You specify the *time* parameter as the delay time you want, in seconds. Delay time can range between 1E-6 (1  $\mu$ s) and 2100 (seconds).

Power-on *time* = automatic (determined by function, range, resolution and ACBAND selection).

Default *time* = automatic (determined by function, range, resolution and ACBAND selection).

## Important Points

- The default or power-on delay changes automatically whenever you change the measurement function (DCV, ACV, etc.), the range, the resolution, or the AC measurement mode (ACBAND command). Table 3-15 shows the default and power-on delays used by the HP 3457 for all combinations of measurement functions, ranges, resolution and ACBAND.
- The power-on or default delay is calculated for the amount of time necessary to process a newly applied AC signal. If you are measuring slowly changing AC amplitudes, you can make a faster series of measurements by specifying a shorter delay time than the HP 3457 would normally use for the present configuration. The resulting settling time, though, may not allow for accurate readings.

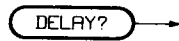
**Example** OUTPUT 722;"DELAY 5" ! INSERTS A 5 SECOND DELAY

# DELAY?

- Front Panel
- Remote

The DELAY? command returns the present delay time, in seconds.

## Syntax DELAY?



## Important Points

- From the HP 3457's front panel, you execute the DELAY? command by accessing the DELAY command from the alphabetic command directory and appending a question mark.
- When you execute the DELAY? command from the HP 3457's front panel, the response goes to the display. When executed from the controller, the response goes to the HP 3457's output buffer in ASCII format. After executing the DELAY? command, the output format returns to the previously specified type (SINT, DINT, SREAL, or ASCII).

## Example

```
10 OUTPUT 722;"DELAY?"      ! RETURNS DELAY TIME
20 ENTER 722;A              ! ENTERS RESPONSE INTO COMPUTER'S A VARIABLE
30 DISP A                   ! DISPLAYS RESPONSE
40 END
```

- Front Panel
- Remote

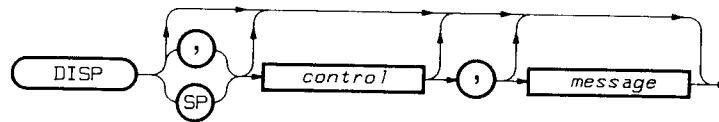
# DIAGNOSTIC

---

This is a service related command. Refer to the HP 3457 service manual for details.

The DISP (display) command enables or disables the HP 3457's display. You can also use it to send a message to the display.

**Syntax** DISP *control,message*



## Parameters

**control** The *control* parameter choices are:

<i>control</i> Parameter	Decimal Equiv.	Description
OFF	0	Displays message, annunciators inactivated; display shuts off in approximately 3 minutes
ON	1	Normal (power-on mode) display operation
MSG	2	Display message, annunciators activated

Power-on *control* = ON.

Default *control* = ON.

**message** The *message* parameter is the message you want to display. The message may contain spaces, any numeral, lower case letters (these are converted and displayed as upper case), upper case letters, and any of the following characters:

! # \$ % & ' ( ) ^ \ / @ ; : [ ] , . + - = \* < > ? \_

## Important Points

- When a delimiter (space, comma, or semicolon) is in the message, you must use quotation marks to indicate to the HP 3457 that the delimiter is part of the message.
- You can only send a message from the controller. The HP 3457 ignores messages originating from its keyboard.
- The HP 3457 displays only the first 12 characters in a message and ignores any additional characters. However, since commas and periods share a display space with the preceding character, they are not considered individual characters.



## DISP (cont)

**Examples**    OUTPUT 722;"DISP OFF,TIME-OUT"                      ! DISPLAYS TIME-OUT

After executing the above line, the annunciators are inactivated and after approximately 3 minutes the display shuts off. Since there are no delimiters in the message, extra quotation marks are not required. When delimiters are in the message, you must add extra quotation marks as shown in the next two examples.

OUTPUT 722;"DISP MSG,"&CHR\$(34)&"TIME OUT"&CHR\$(34)    ! DISPLAYS TIME OUT

The above line works on both HP Series-80 and Series-200 controllers. Notice that the space delimiter is in the message. Since you cannot embed quotation marks on some Series-80 controllers, this line uses the ASCII equivalent (CHR\$(34)). Also, the & character is used to concatenate strings.

OUTPUT 722;"DISP OFF,"""TIME OUT""                      ! DISPLAYS TIME OUT

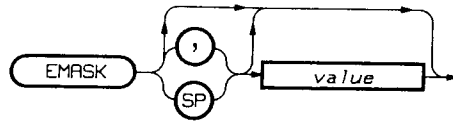
The above line works on HP Series-200 controllers and takes advantage of the fact that the controller allows you to embed quotation marks.

# EMASK

- Front Panel
- Remote

The EMASK (error mask) command allows you to designate which error conditions will set the error bit (bit 5) in the status register.

**Syntax** EMASK *value*



## Parameters

***value*** You enable (designate) an error condition by specifying its decimal weight as the *value* parameter. For more than one error condition, specify the sum of the weights. The error conditions and their weights are:

Decimal Weight	Bit Number	Enables Error Condition
1	0	Hardware error – check the auxiliary error register
2	1	Error in the CAL or ACAL process
4	2	Trigger too fast
8	3	Syntax error
16	4	Unknown command received
32	5	Unknown parameter received
64	6	Parameter out of range
128	7	Required parameter missing
256	8	Parameter ignored
512	9	Out of calibration
1024	10	Autocal required

Power-on *value* = 2047 (all enabled).

Default *value* = 2047 (all enabled).

## Important Points

- When an error occurs, it sets the corresponding bit in the error register regardless of whether it has been enabled by the EMASK command.

## Examples

OUTPUT 722;"EMASK 4" ! ENABLES THE TRIGGER TOO FAST ERROR

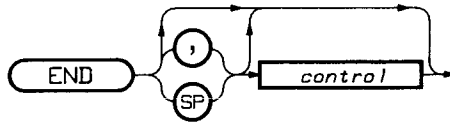
OUTPUT 722;"EMASK 40" ! ENABLES SYNTAX (8) & UNKNOWN PARAMETER (32) ERRORS

OUTPUT 722;"EMASK 2047" ! ENABLES ALL ERRORS

OUTPUT 722;"EMASK 0" ! DISABLES ALL ERRORS

The END command enables or disables the HP-IB *End Or Identify* (EOI) function. When enabled, the HP-IB EOI line is set true concurrent with the transmission of the last data byte for any output format.

**Syntax** END *control*



**Parameters**

*control* The *control* parameter choices are:

<i>control</i> Parameter	Decimal Equiv.	Description
OFF	0	EOI line never set true
ALWAYS	2	EOI line set true concurrent with last data byte

Power-on *control* = OFF.  
 Default *control* = ALWAYS.

**Important Points**

- The ASCII output format sends <CR> <LF> (carriage-return line-feed) on the data bus following each transmission of data. This indicates the end of the transmission to most computers. The other output formats (DINT, SINT, and SREAL) do not send <CR> <LF>. With these formats you can set END to ALWAYS to indicate the end of the transmission.
- Check your computer manual for information on how your computer responds to the EOI line.

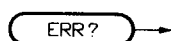
**Example** OUTPUT 722;"END ALWAYS" ! ENABLES HP-IB EOI

# ERR?

- Front Panel
- Remote

When an error occurs, it sets a bit in the error register and causes the display's ERR annunciator to flash. The ERR? (error?) command returns a number representing all set bits, clears the register, and shuts-off the annunciator. The returned number is the weighted sum of all set bits.

## Syntax ERR?



## Error Conditions

The error conditions and their weighted values are:

Weighted Value	Bit Number	Error Conditions
1	0	Hardware error—check the auxiliary error register
2	1	Error in the CAL or ACAL process
4	2	Trigger too fast
8	3	Syntax error
16	4	Unknown command received
32	5	Unknown parameter received
64	6	Parameter out of range
128	7	Required parameter missing
256	8	Parameter ignored
512	9	Out of calibration
1024	10	Autocal required

## Important Points

- The ERR? command returns a 0 if no error bits are set.
- If bit 0 is set (weight = 1), refer to the auxiliary error register (AUXERR? command) for more information.
- Executing the ERR? command clears the status register's error bit (bit 5).
- The shifted ERROR key on the HP 3457's front panel displays and clears error bits one at a time.
- When you execute the ERR? command from the HP 3457's front panel, the response goes to the display. When executed from the controller, the response goes to the HP 3457's output buffer in ASCII format. After executing the ERR? command, the output format returns to the previously specified type (SINT, DINT, SREAL, or ASCII).

## ERR? (cont)

<b>Example</b>	10 OUTPUT 722;"ERR?"	! READS & CLEARS ERROR REGISTER
	20 ENTER 722;A	! ENTERS WEIGHTED SUM INTO VARIABLE A
	30 DISP A	! DISPLAYS WEIGHTED SUM
	40 END	

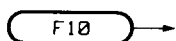
Assume the above program returns the weighted sum 513. This means the errors with weighted values 1 (hardware error) and 512 (out of calibration) have occurred.

# F10 – F58

Front Panel  
 Remote

The F10 through F58 commands are special high speed commands that select DC voltage, 2-wire ohms, or 4-wire ohms measurements and the measurement range. The F10 - F58 commands configure the HP 3457 much more rapidly than their function command counterparts (DCV, OHM, or OHMF).

## Syntax F10 (typical)



The F10 - F58 commands and the functions and ranges they select are:

Command	Selects Function	Selects Range
F10	DC Voltage	Autorange
F11	DC Voltage	30 mV
F12	DC Voltage	300 mV
F13	DC Voltage	3 V
F14	DC Voltage	30 V
F15	DC Voltage	300 V
F40	2-Wire Ohms	Autorange
F41	2-Wire Ohms	30 $\Omega$
F42	2-Wire Ohms	300 $\Omega$
F43	2-Wire Ohms	3 k $\Omega$
F44	2-Wire Ohms	30 k $\Omega$
F45	2-Wire Ohms	300 k $\Omega$
F46	2-Wire Ohms	3 M $\Omega$
F47	2-Wire Ohms	30 M $\Omega$
F48	2-Wire Ohms	3 G $\Omega$
F50	4-Wire Ohms	Autorange
F51	4-Wire Ohms	30 $\Omega$
F52	4-Wire Ohms	300 $\Omega$
F53	4-Wire Ohms	3 k $\Omega$
F54	4-Wire Ohms	30 k $\Omega$
F55	4-Wire Ohms	300 k $\Omega$
F56	4-Wire Ohms	3 M $\Omega$
F57	4-Wire Ohms	30 M $\Omega$
F58	4-Wire Ohms	3 G $\Omega$

## F10–F58 (cont)

### Important Points

- You can append another HP 3457 command to an F10 - F58 command without the need for a delimiter. This is shown in the second example below.
- If you attempt to store an F10 - F58 command in a subprogram, the HP 3457 aborts subprogram storage and flags the SYNTAX ERROR (bit 3).
- If the input buffer is enabled (INBUF ON command) and you send an F10 - F58 command, the HP 3457 (1) holds the bus, (2) empties the buffer, (3) executes the F10 - F58 command, and (4) releases the bus.

### Examples

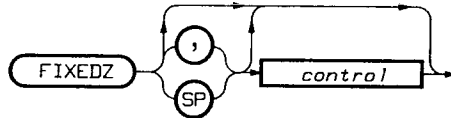
```
OUTPUT 722;"F43"           ! SELECTS 2-WIRE OHMS, 3 KΩ RANGE
OUTPUT 722;"F10BEEP"       ! SELECTS DC VOLTAGE, AUTORANGE, BEEPS ONCE
```

# FIXEDZ

- Front Panel
- Remote

The FIXEDZ (fixed impedance) command enables or disables the fixed input impedance function for DC voltage measurements. When enabled, the HP 3457 maintains its input impedance at 10 megohms for all ranges. This prevents a change in input impedance (caused by a range change) from affecting the DC voltage measurements.

**Syntax** `FIXEDZ control`



## Parameters

*control* The *control* parameter choices are:

<i>control</i> Parameter	Decimal Equiv.	Description	Input Impedances	
			DCV .03, .3, 3V ranges	DCV 30, 300V ranges
OFF	0	FIXEDZ disabled	10 G $\Omega$	10 M $\Omega$
ON	1	FIXEDZ enabled	10 M $\Omega$	10 M $\Omega$

Power-on *control* = OFF.

Default *control* = ON.

## Important Points

- FIXEDZ remains enabled when you change from DC voltage measurements to 2-wire or 4-wire ohms measurements. For example, if FIXEDZ is enabled and you change from DC voltage measurements to 2-wire ohms, FIXEDZ remains enabled and the HP 3457 measures the 10 megohm FIXEDZ resistor.
- FIXEDZ is temporarily disabled when you change from DC voltage measurements to AC voltage, AC + DC voltage, any type of current, frequency, or period measurements. For example, if FIXEDZ is enabled and you change from DC voltage measurements to AC voltage measurements, FIXEDZ becomes disabled. When you return to DC voltage measurements, however, FIXEDZ is once again enabled.

## Example

OUTPUT 722;"FIXEDZ ON" ! ENABLES FIXED IMPEDANCE



The **FIXEDZ?** (fixed impedance?) command returns a number indicating whether fixed input impedance is on or off: 1 = ON, 0 = OFF.

## Syntax **FIXEDZ?**

**FIXEDZ?** →

## Important Points

- When you execute the **FIXEDZ?** command from the HP 3457's front panel, the response goes to the display. When executed from the controller, the response goes to the HP 3457's output buffer in ASCII format. After executing the **FIXEDZ** command, the output format returns to the previously specified type (SINT, DINT, SREAL, or ASCII).

## Example

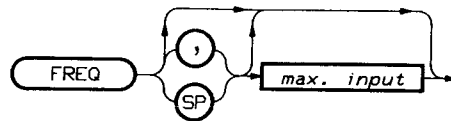
```
10 OUTPUT 722;"FIXEDZ?"      ! RETURNS FIXEDZ STATE
20 ENTER 722;A               ! ENTERS RESPONSE INTO VARIABLE A
30 DISP A                    ! DISPLAYS RESPONSE
40 END
```

# FREQ

□ Front Panel  
■ Remote

The FREQ (frequency) command instructs the HP 3457 to measure frequency. It also allows you to specify the amplitude range of the input signal.

**Syntax** FREQ *max. input*



## Parameters

*max. input*

### NOTE

The *max. input* parameter selects the amplitude range of the input signal not the frequency range (Hz).

The *max. input* parameter selects a standard range or the autorange mode. To select a standard range, you specify *max. input* as the maximum expected amplitude of the input signal. The HP 3457 then selects the correct range.

To select the autorange mode, specify AUTO for *max. input* or default the parameter. In the autorange mode, the HP 3457 samples the input signal before each measurement and selects the appropriate range.

The *max. input* choices are:

For AC or AC + DC Voltage:

<i>max. input</i> Parameter	Selects Range
-1 or AUTO	Autorange
0 - .03	30 mV
>.03 - .3	300 mV
>.3 - 3	3 V
>3 - 30	30 V
>30 - 300	300 V

For AC or AC + DC Current:

<i>max input</i> Parameter	Selects Range
-1 or AUTO	Autorange
0 1 .03	30 mA
>.03 - .3	300 mA
>.3 - 1	1 A

Power-on *max. input* = none.

Default *max. input* = AUTO.

## FREQ (cont)

### Important Points

- You use the FREQ command along with the FSOURCE command. The FSOURCE command designates whether the input signal is AC voltage, AC+DC voltage, AC current, or AC+DC current.
- Seven digits of resolution are always provided for frequency measurements regardless of the specified amount of integration time (NPLC command). The integration time does, however, affect the measurement speed (the greater the integration time = the slower the measurements).
- From the front panel, you select frequency measurements using the FREQ key or by accessing the FUNC command from the alphabetic command directory. The FREQ key does not allow you to select any additional parameters. With the FUNC command, you can specify the measurement range and resolution.

### Example

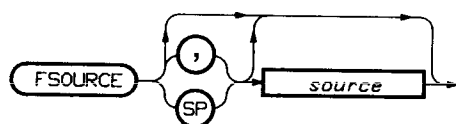
```
10 OUTPUT 722;"FSOURCE ACI"      ! SELECTS AC CURRENT AS INPUT SOURCE
20 OUTPUT 722;"FREQ .03"         ! SELECTS FREQUENCY MEASUREMENTS, 30mA RANGE
30 END
```

# FSOURCE

- Front Panel
- Remote

The FSOURCE (frequency source) command configures the HP 3457 to accept either AC voltage, AC+DC voltage, AC current, or AC+DC current as the input signal for frequency or period measurements.

**Syntax** FSOURCE *source*



## Parameters

*source* The *source* parameter choices are:

<i>source</i> Parameter	Decimal Equiv.	Description
ACV	2	Configures the HP 3457 for an AC voltage input
ACDCV	3	Configures the HP 3457 for an AC + DC voltage input
ACI	7	Configures the HP 3457 for an AC current input
ACDCI	8	Configures the HP 3457 for an AC + DC current input

Power-on *source* = ACV.

Default *source* = ACV.

## Important Points

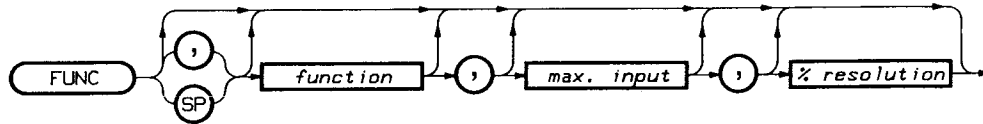
- The FSOURCE command does not alter the present ACBAND (AC fast or slow) configuration.

## Example

```
10 OUTPUT 722;"FSOURCE ACDCI" ! SELECTS AC+DC CURRENT AS THE INPUT SOURCE
20 OUTPUT 722;"FREQ .03" ! SELECTS FREQUENCY MEASUREMENTS, 30mA RANGE
30 END
```

The FUNC (function) command selects the type of measurement (AC voltage, DC current, etc.). It also allows you to specify the measurement range and resolution.

**Syntax** *FUNC function,max. input,% resolution*



## Parameters

***function*** The *function* parameter designates the type of measurement. The parameter choices are:

<i>function</i> Parameter	Decimal Equiv.	Description
DCV	1	Selects DC voltage measurements
ACV	2	Selects AC voltage measurements
ACDCV	3	Selects AC + DC voltage measurements
OHM	4	Selects 2-wire ohms measurements
OHMF	5	Selects 4-wire ohms measurements
DCI	6	Selects DC current measurements
ACI	7	Selects AC current measurements
ACDCI	8	Selects AC + DC current measurements
FREQ	9	Selects frequency measurements
PER	10	Selects period measurements

Power-on *function* = DCV.

Default *function* = DCV.

***max. input*** The *max. input* parameter selects a standard range or the autorange mode. To select a standard range, you specify *max. input* as the input signal's maximum expected amplitude (or the maximum resistance for ohms measurements). The HP 3457 then selects the correct range.

To select autorange, specify AUTO for *max. input* or default the parameter. In the autorange mode, the HP 3457 samples the input signal before each measurement and selects the appropriate range.

# FUNC (cont)

The *max. input* choices for the various measurement functions are:

For Voltage Measurements:

<i>max. input</i> Parameter	Selects Range	Full Scale Reading
-1 or AUTO	Autorange	
0 - .03	30 mV	30.3 mVDC, 32.5 mVAC
>.03 - .3	300 mV	303 mVDC, 325 mVAC
>.3 - 3	3 V	3.03 VDC, 3.25 VAC
>3 - 30	30 V	30.3 VDC, 32.5 VAC
>30 - 300	300 V	303 VDC, 303 VAC

For AC Current Measurements:

<i>max input</i> Parameter	Selects Range	Full Scale Reading
-1 or AUTO	Autorange	
0 - .03	30 mA	32.5 mA
>.03 - .3	300 mA	325 mA
>.3 - 1	1 A	1.05 A

For DC Current Measurements:

<i>max. input</i> Parameter	Selects Range	Full Scale Reading
-1 or AUTO	Autorange	
0 - .0003	300 $\mu$ A	303 $\mu$ A
>.0003 - .003	3 mA	3.03 mA
>.003 - .03	30 mA	30.3 mA
>.03 - .3	300 mA	303 mA
>.3 - 1.5	1.5 A	1.5 A

For Ohms Measurements:

<i>max input</i> Parameter	Selects Range	Full Scale Reading
-1 or AUTO	Autorange	
0 - 30	30 $\Omega$	30.3 $\Omega$
>3 - 300	300 $\Omega$	303 $\Omega$
>300 - 3E3	3 k $\Omega$	3.03 k $\Omega$
>3E3 - 3E4	30 k $\Omega$	30.3 k $\Omega$
>3E4 - 3E5	300 k $\Omega$	303 k $\Omega$
>3E5 - 3E6	3 M $\Omega$	3.03 M $\Omega$
>3E6 - 3E7	30 M $\Omega$	30.3 M $\Omega$
>3E7 - 3E9	3 G $\Omega$	3.03 G $\Omega$

Power-on *max. input* = AUTO.

Default *max. input* = AUTO.

**% resolution** You specify the *% resolution* parameter as a percentage of the *max. input* parameter. The HP 3457 then multiplies *% resolution* times *max. input* to determine the measurement's resolution.

For example, suppose your maximum expected input is 10V and you want 1mV of resolution. To determine *% resolution*, use the equation:

$$\% \text{ resolution} = (\text{actual resolution}/\text{maximum input}) \times 100$$

For this example, the equation evaluates to:

$$\% \text{ resolution} = (.001/10) \times 100 = .0001 \times 100 = .01$$

---

### NOTE

*When using autorange, the HP 3457 multiplies the % resolution parameter times the full scale reading of the selected range. The result is the minimum resolution. The HP 3457 always gives you at least the minimum resolution and, in many cases, it gives you an additional digit of resolution.*

---

Power-on *% resolution* = determined by the integration time specified in the NPLC command.

Default *% resolution* = determined by the integration time specified in the NPLC command.

### Important Points

- The power-on value for number of digits (NDIG) is 5. This masks one display digit. Set the number of digits to 6 to view the remaining digit.
- The HP 3457 changes the measurement resolution by changing the amount of time during which it samples the input signal (integration time). Both the *% resolution* parameter and the NPLC command affect the integration time. When you execute a function command (ACV, DCV, ACI, etc.) the HP 3457 compares the integration time specified by *% resolution* to that specified by the NPLC command. The HP 3457 then uses the parameter or command that specifies the longest integration time (most resolution). Since the NPLC command's power-on value is 10 PLCs, you must lower the number of PLCs to get less resolution (this is shown in the following example).

## FUNC (cont)

### Examples

```
10 OUTPUT 722;"NPLC .0005"           ! SETS PLCS TO MINIMUM
20 OUTPUT 722;"FUNC DCV,6,.0167"     ! SELECTS DC VOLTAGE, 6V MAX,.0167%
                                       RESOLUTION
30 END
```

In the above program, line 10 allows *% resolution* in line 20 to control the resolution. The resolution specified by line 20 is  $6V \times .000167 = .001V$ .

```
10 OUTPUT 722;"NPLC .0005"           ! SETS PLCS TO MINIMUM
20 OUTPUT 722;"FUNC ACI,AUTO,.033"   ! SELECTS AC CURRENT, AUTORANGE, .033%
                                       RESOLUTION
30 END
```

In the above program, line 10 allows *% resolution* in line 20 to control the resolution. In this example, the HP 3457 provides at least .033% resolution for full scale readings on whatever range autorange selects.

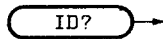
```
10 OUTPUT 722;"NPLC 100"             ! SETS PLCS TO MAXIMUM
20 OUTPUT 722;"FUNC OHM,1E3,.01"     ! SELECTS 2-WIRE OHMS, 1KΩ MAX, .1%
                                       RESOLUTION
30 END
```

In the above program, line 10 sets the number of PLCs to 100. This corresponds to maximum resolution and prevents *% resolution* in line 20 from affecting the measurement. The requested resolution from line 20 is  $1 \text{ k}\Omega \times .0001 = .1 \Omega$ . However, because of line 10, the actual resolution is  $.000001 \Omega$ .



The ID? (identity?) command returns the response “HP3457A”. This allows you to easily locate the HP 3457, by its address, from remote.

## Syntax ID?



## Important Points

- The response “HP3457A” contains alpha and numeric characters. Some computer variables can only store numeric characters. When you use one of these variables, only the numeric (3457) is stored.
- When you execute the ID? command from the HP 3457’s front panel, the response goes to the display. When executed from the controller, the response goes to the HP 3457’s output buffer in ASCII format. After executing the ID? command, the output format returns to the previously specified type (SINT, DINT, SREAL, or ASCII).

## Examples

```
10 OUTPUT 722;"ID?"           ! RETURNS RESPONSE
20 ENTER 722;A                ! ENTERS RESPONSE INTO THE COMPUTER'S A VARIABLE
30 DISP A                     ! DISPLAYS RESPONSE
40 END
```

The above program uses the simple variable A in which to store the response. On an HP series 80 computer, for example, simple variables can only store numeric characters. In this case, the numeric 3457 is stored and displayed.

```
10 OUTPUT 722;"ID?"           ! RETURNS RESPONSE
20 ENTER 722;A$               ! ENTERS RESPONSE INTO THE COMPUTER'S A$ VARIABLE
30 DISP A$                    ! DISPLAYS RESPONSE
40 END
```

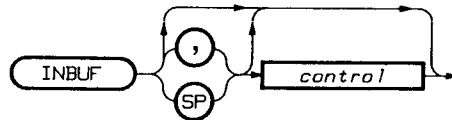
The above program uses a string variable A\$. On an HP series 80 computer, for example, string variables can store both alpha and numeric characters. In this case, the entire response “HP3457A” is stored and displayed.

# INBUF

- Front Panel
- Remote

The INBUF (input buffer) command enables or disables the HP 3457's input buffer. When enabled, the input buffer temporarily stores the commands it receives over the HP-IB bus. This releases the HP-IB bus immediately after the command is received, allowing the controller to perform other tasks while the HP 3457 is executing commands.

**Syntax** INBUF *control*



## Parameters

*control* The *control* parameter choices are:

<i>control</i> Parameter	Decimal Equiv.	Description
OFF	0	Disables the input buffer – commands are only accepted when the HP 3457 is not busy
ON	1	Enables the input buffer – commands are stored releasing the bus immediately

Power-on *control* = OFF.

Default *control* = ON.

## Important Points

- When the input buffer is ON, you lose synchronization with the controller. Monitor the ready bit in the HP 3457's status register to determine when the contents of the input buffer have been executed (see the example below).
- If you send more commands than the input buffer can store, the HP 3457 holds the bus until a command is executed – making buffer space available. By doing this, no commands are lost because of a full input buffer. The input buffer is 255 bytes long. You can use the procedure under “Subprogram Storage” in Chapter 3 to determine the number of bytes required per command.

## INBUF (cont)

- The input buffer functions differently when you send an F10—F58 command. If the input buffer is enabled and you send an F10—F58 command, the HP 3457 (1) hold the bus, (2) empties the buffer, (3) executes the F10—×58 command, and (4) releases the bus.

### Example

```
10 OUTPUT 722;"INBUF ON"      ! ENABLES THE INPUT BUFFER
20 OUTPUT 722;"TRIG HOLD"     ! SUSPENDS TRIGGERING
30 OUTPUT 722;"NPLC 10"       ! SETS PLCS TO 10
40 OUTPUT 722;"NRDGS,10,AUTO"! SELECTS 10 READINGS PER TRIGGER, AUTO SAMPLE
                               EVENT
50 OUTPUT 722;"OHM"           ! SELECTS 2-WIRE OHMS MEASUREMENTS
60 P=SPOLL(722)               ! READS THE STATUS BYTE
70 IF BIT(P,4)=1 THEN GOTO 60  ! MONITORS BIT 4 (READY BIT)
80 OUTPUT 722;"TRIG SGL"      ! GENERATES A SINGLE TRIGGER
90 END
```

In the above program, lines 20 through 50 are placed in the input buffer and executed one at a time. Lines 60 and 70 monitor the ready bit until it goes to 0. When the ready bit goes to 0 (line 70), the commands in the input buffer have been executed. Line 80 triggers the HP 3457 causing it to make the ohms measurements.

# ISCALE?

- Front Panel
- Remote

The ISCALE? (integer scale?) command returns the scale factor for a particular reading. When using the SINT or DINT output format, you can multiply the scale factor times the reading to convert it from integer format into fundamental units (volts, ohms, etc.).

## Syntax ISCALE?

ISCALE? →

## Important Points

- The scale factor is always 1 for the ASCII and SREAL output formats.
- When using the SINT or DINT output format, the HP 3457 calculates a scale factor for each reading. This scale factor is based on the present measurement function, range, A/D setting, and enabled math operations. When you send the ISCALE? command, the HP 3457 returns a scale factor based on the present measurement function, range, A/D setting, and enabled math operations. Therefore, ensure that the HP 3457's configuration is the same when making measurements as it is when you retrieve the scale factor.
- When using autorange and the DINT or SINT output format, a different scale factor may be applied for each range change. Tables 3-11 and 3-12 show the scale factors for all ranges in the SINT and DINT output formats.
- When a math function is enabled (except STAT or PFAIL), the scale factor is always 1. When using the SINT or DINT output format with a math function enabled, you will be unable to use the ISCALE? command to retrieve the correct scale factor. Use Table 3-11 or 3-12 to determine the scale factor.
- Always retrieve the reading from the output buffer before sending the ISCALE? command from the controller. If you send the ISCALE? command first, the reading may be destroyed.
- When you execute the ISCALE? command from the HP 3457's front panel, the scale factor goes to the display. When executed from the controller, the scale factor goes to the HP 3457's output buffer in ASCII

## ISCALE? (cont)

format. After executing the ISCALE? command, the output format returns to the previously specified type (SINT, DINT, SREAL, or ASCII).

- You specify the output format using the OFORMAT command.

### Examples

**DINT Format**

```
10 OUTPUT 722;"DCV"           ! SELECTS DC VOLTAGE MEASUREMENTS
20 OUTPUT 722;"OFORMAT DINT"  ! SELECTS THE DINT OUTPUT FORMAT
30 OUTPUT 722;"TRIG SGL"      ! TRIGGERS ONE MEASUREMENT
40 ENTER 722 USING "#,B" ; A,B,C,D ! ENTERS READING INTO A,B,C,D VARIABLES
50 T = A*16777216 + B*65536 + C*256 + D ! CONVERTS READING
60 IF A > 127 THEN T = T - 4294967296 ! CORRECTS NEGATIVE READING
70 OUTPUT 722;"ISCALE?"       ! RETURNS SCALE FACTOR
80 ENTER 722;I                 ! STORES SCALE FACTOR IN I VARIABLE
90 R = T*I                     ! MULTIPLIES CONVERTED READING TIMES
                               ! SCALE FACTOR
100 DISP R                     ! DISPLAYS READING IN VOLTS
110 END
```

In the above program, the reading is entered into the A, B, C, and D variables using the image specifiers # and B (line 40). The # image specifier suppresses the need for <CR> <LF> (carriage return, line feed ) following the data transmission. The B image specifier, enters the reading in four 8-bit bytes.

**SINT Format**

```
10 OUTPUT 722;"DCV"           ! SELECTS DC VOLTAGE MEASUREMENTS
20 OUTPUT 722;"OFORMAT SINT"  ! SELECTS THE SINT OUTPUT FORMAT
30 OUTPUT 722;"TRIG SGL"      ! TRIGGERS ONE MEASUREMENT
40 ENTER 722 USING "#,W";A     ! ENTERS READING INTO A VARIABLE
50 OUTPUT 722;"ISCALE?"       ! RETURNS SCALE FACTOR
60 ENTER 722;I                 ! STORES SCALE FACTOR IN I VARIABLE
70 R = A*I                     ! MULTIPLIES READING TIMES SCALE FACTOR
80 DISP R                       ! DISPLAYS READING IN VOLTS
90 END
```

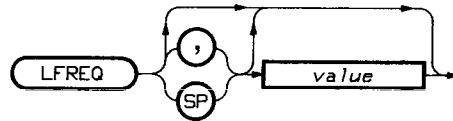
In the above program, the reading is entered into the A variable using the image specifiers # and W (line 40). The # image specifier suppresses the need for <CR> <LF> (carriage return, line feed ) following the data transmission. The W image specifier, enters the reading in two 8-bit bytes.

# LFREQ

- Front Panel
- Remote

The LFREQ (line frequency) command allows you to change the line frequency reference used by the HP 3457's A/D converter.

**Syntax** LFREQ *value*



## Parameters

*value* You specify the *value* parameter as 50 or 60 (Hz).

Power-on *value* = measured line frequency (either 50 or 60 Hz).

Default *value* = present value.

## Important Points

- When power is applied, the HP 3457 measures the line frequency and uses that value for the A/D converter's reference. You only need to use the LFREQ command if, for some reason, you want to change that frequency.

**Example** OUTPUT 722;"LFREQ 50" ! SETS REFERENCE FREQUENCY TO 50 Hz

The LFREQ? (line frequency?) command returns the value of the line frequency reference used by the HP 3457's A/D converter.

## Syntax LFREQ?

LFREQ?

## Important Points

- Do not confuse the LFREQ? command with the LINE? command. The LFREQ? command returns the specified reference frequency used by the HP 3457's A/D converter. The LINE? command measures and returns the AC line power's actual frequency.
- From the HP 3457's front panel, you execute the LFREQ? command by accessing the LFREQ command from the alphabetic command directory and appending a question mark.
- When you execute the LFREQ? command from the HP 3457's front panel, the response goes to the display. When executed from the controller, the response goes to the HP 3457's output buffer in ASCII format. After executing the LFREQ? command, the output format returns to the previously specified type (SINT, DINT, SREAL, or ASCII).

## Example

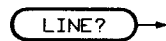
```
10 OUTPUT 722;"LFREQ?"      ! RETURNS THE LINE FREQUENCY REFERENCE
20 ENTER 722;A              ! ENTERS RESPONSE INTO VARIABLE A
30 DISP A                   ! DISPLAYS RESPONSE
40 END
```

# LINE?

- Front Panel
- Remote

The LINE? command measures and returns the AC line power frequency.

**Syntax** LINE?



## Important Points

- The LINE? command does not affect the line frequency reference used by the A/D converter.
- When you execute the LINE? command from the HP 3457's front panel, the response goes to the display. When executed from the controller, the response goes to the HP 3457's output buffer in ASCII format. After executing the LINE? command, the output format returns to the previously specified type (SINT, DINT, SREAL, or ASCII).

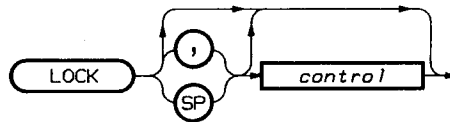
## Example

```
10 OUTPUT 722;"LINE?"      ! MEASURES THE LINE FREQUENCY
20 ENTER 722;A             ! ENTERS RESPONSE INTO COMPUTER'S A VARIABLE
30 DISP A                  ! DISPLAYS RESPONSE
40 END
```



The LOCK (lockout) command enables or disables the HP 3457's keyboard.

**Syntax** `LOCK control`



## Parameters

*control* The *control* parameter choices are:

<i>control</i> Parameter	Decimal Equiv.	Description
OFF	0	Enables the keyboard (normal operation)
ON	1	Disables the keyboard (pressing keys has no affect)

Power-on *control* = OFF.

Default *control* = ON.

## Important Points

- The LOCK command is accessible from the front panel's alphabetic command directory. However, executing the LOCK command from the front panel has no effect.
- When the keyboard is disabled, the HP 3457's reading rate increases slightly since it no longer scans the keyboard between measurements.
- After disabling the keyboard, you can only enable it from the controller or by cycling power. The LOCK command disables the HP 3457's LOCAL key.

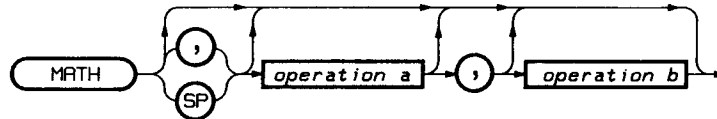
**Example** `OUTPUT 722;"LOCK ON" ! DISABLES THE KEYBOARD`

# MATH

■ Front Panel  
■ Remote

The MATH command enables or disables math operations.

**Syntax** MATH *operation a,operation b*



## Parameters

*operation a/operation b* The *operation* parameter choices are:

<i>operation</i> Parameter	Decimal Equiv.	Description
OFF	0	Suspends any math operations
CONT	1	Enables the previous math operation. To resume two math operations send MATH CONT,CONT
CTHRM	3	Result = temperature (Celsius) of a 5kΩ thermistor (HP 0837-0164). Function must be OHM or OHMF (30kΩ range or higher).
DB	4	Result = $20 \times \log_{10}(\text{reading}/\text{REF register})$ . The REF register is initialized to 1 yielding dBV.
DBM	5	Result = $20 \times \log_{10}(\text{reading}^2/\text{RES register}/1\text{mW})$ . Function must be ACV, DCV, or ACDCV.
FILTER	6	Result = output of exponentially weighted digital low-pass filter. Step response is set by DEGREE register.
FTHRM	8	Result = temperature (Fahrenheit) of a 5kΩ thermistor (HP 0837-0164). Function must be OHM or OHMF (30kΩ range or higher).
NULL	9	Result = reading-OFFSET register. The OFFSET register is set to first reading – after that you can change it.
PERC	10	Result = $(\text{reading}-\text{PERC register})/\text{PERC register} \times 100$ .
PFAIL	11	Reading vs. MAX and MIN registers.
RMS	12	Result = squares reading, applies FILTER operation, takes square root.
SCALE	13	Result = $(\text{reading}-\text{OFFSET register})/\text{SCALE register}$
STAT	14	Performs statistical calculations on the present set of measurements and stores results in these registers: SDEV = standard deviation MEAN = average of readings NSAMP = number of readings UPPER = largest reading LOWER = smallest reading

## MATH (cont)

Power-on *operation a,b* = OFF,OFF.

Power-on register values = all registers are set to 0 with the following exceptions:

DEGREE = 20  
SCALE = 1  
PERC = 1  
REF = 1  
RES = 50

Default *operation a,b* = OFF,OFF.

### Important Points

- When you enable a math operation, you disable any previous operation.
- An enabled math operation is done on every subsequent reading. It stays enabled until you set MATH OFF or replace it by enabling another math operation.
- When two math operations are enabled, *operation a* is performed on the reading first. Next, *operation b* is performed on the result of the first operation.
- When a math operation is enabled, the display's ½ digit becomes a full digit. For example, if you are making 4½ digit AC voltage measurements, and then enable the SCALE math function, the display is capable of showing 5 full digits.
- You set math registers with the SMATH command. You read math registers using the RMATH command.

## MATH (cont)

**Example**

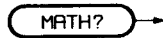
```
10 OUTPUT 722;"OHM"           ! SELECTS 2-WIRE OHMS
20 OUTPUT 722;"TRIG HOLD"     ! SUSPENDS TRIGGERING
30 OUTPUT 722;"MATH NULL,FTHRM" ! ENABLES NULL & FTHRM MATH
40 DISP "SHORT LEADS, PRESS CONT" ! OPERATOR INSTRUCTIONS
50 PAUSE                       ! PAUSES PROGRAM
60 OUTPUT 722;"TRIG SGL"      ! TRIGGERS 1 READING
70 DISP "CONNECT THERM.,PRESS CONT" ! OPERATOR INSTRUCTIONS
80 PAUSE                       ! PAUSES PROGRAM
90 OUTPUT 722;"TRIG AUTO"     ! SETS TRIGGERING TO AUTO
100 END
```

In the above program, line 40 instructs the operator to short the test leads and press continue. After continue is pressed, the HP 3457 measures the test lead resistance. Since this is the first reading, it is placed in the OFFSET register. Line 70 instructs the operator to connect the test leads to the thermistor and press continue. Line 90 sets the trigger mode to AUTO. In operation, the value in the OFFSET register is subtracted from each reading. The HP 3457 then calculates the Fahrenheit temperature and displays the result.

The MATH? command returns two numbers, separated by a comma, indicating the enabled math functions. The functions and their numbers are:

OFF = 0	NULL = 9
CTHRM = 3	PERC = 10
DB = 4	PFAIL = 11
DBM = 5	RMS = 12
FILTER = 6	SCALE = 13
FTHRM = 8	STAT = 14

## Syntax MATH?



## Important Points

- From the HP 3457's front panel, you execute the MATH? command by accessing the MATH command from the alphabetic command directory and appending a question mark.
- When you execute the MATH? command from the HP 3457's front panel, the response goes to the display. When executed from the controller, the response goes to the HP 3457's output buffer in ASCII format. After executing the MATH? command, the output format returns to the previously specified type (SINT, DINT, SREAL, or ASCII).

## Example

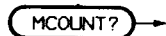
```
10 OUTPUT 722;"MATH?"           ! RETURNS THE MATH FUNCTION NUMBERS
20 ENTER 722;A,B                 ! ENTERS NUMBERS INTO VARIABLES A & B
30 DISP A,B                       ! DISPLAYS NUMBERS
40 END
```

# MCOUNT?

- Front Panel
- Remote

The MCOUNT? (memory count?) command returns the total number of stored readings.

**Syntax** MCOUNT?



## Important Points

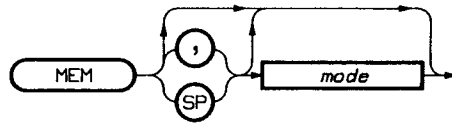
- When you execute the MCOUNT? command from the HP 3457's front panel, the response goes to the display. When executed from the controller, the response goes to the HP 3457's output buffer in ASCII format. After executing the MCOUNT? command, the output format returns to the previously specified type (SINT, DINT, SREAL, or ASCII).

## Example

```
10 OUTPUT 722;"MCOUNT?"      ! RETURNS TOTAL NUMBER OF STORED READINGS
20 ENTER 722;A                ! ENTERS RESPONSE INTO A VARIABLE
30 DISP A                      ! DISPLAYS RESPONSE
40 END
```

The MEM (memory) command enables or disables reading memory and designates the storage mode.

**Syntax** MEM *mode*



## Parameters

*mode* The *mode* parameter choices are:

<i>mode</i> Parameter	Decimal Equiv.	Description
OFF	0	Stops storing readings (stored readings stay intact)
LIFO	1	Clears reading memory and stores new readings LIFO (last-in-first-out)
FIFO	2	Clears reading memory and stores new readings FIFO (first-in-first-out)
CONT	3	Keeps memory intact and selects previous mode (if there was no previous mode, FIFO is selected)

Power-on *mode* = OFF.

Default *mode* = FIFO.

## Important Points

- If you fill memory in the FIFO mode, the stored data remains intact and new readings are not stored. If you fill memory in the LIFO mode, the oldest readings are replaced with the new readings. In the LIFO mode, the most recent readings are always available.
- If the controller requests data from the HP 3457 when its output buffer is empty in the LIFO or FIFO mode, a reading is removed from memory and placed in the output buffer. This is the “implied read” method of recalling readings. In the LIFO mode, the most recent reading is returned. In the FIFO mode, the oldest reading is returned.

## MEM (cont)

- The reading storage mode (LIFO or FIFO) is important only when you are using the “implied read” method of recalling readings. The reading storage mode has no affect on readings recalled using the RMEM command.
- You specify the memory format (SINT, DINT, ASCII, or SREAL) using the MFORMAT command. You allocate the memory space using the MSIZE command.

### Examples

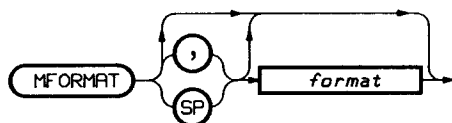
```
OUTPUT 722;"MEM FIFO"           ! ENABLES READING MEMORY, FIFO MODE

10 OUTPUT 722;"NPLC 10"         ! SELECTS 10 PLCS OF INTEGRATION TIME
20 OUTPUT 722;"DCV 3"           ! SELECTS DC VOLTAGE, 3 V RANGE
30 OUTPUT 722;"MSIZE 992"       ! ALLOCATES 992 BYTES FOR READING MEMORY
40 OUTPUT 722;"MEM FIFO"       ! ENABLES READING MEMORY (FIFO MODE)
50 OUTPUT 722;"MFORMAT ASCII"   ! SELECTS ASCII MEMORY FORMAT
60 END
```



The MFORMAT (memory format) command clears reading memory and designates the storage format for new readings.

**Syntax** MFORMAT *format*



## Parameters

*format* The *format* parameter choices are:

<i>format</i> Parameter	Decimal Equiv.	Description
ASCII	1	ASCII – 14 characters followed by <CR> <LF> (16 bytes per reading)
SINT	2	Single Integer – 16 bits 2's complement (2 bytes per reading)
DINT	3	Double Integer – 32 bits 2's complement (4 bytes per reading)
SREAL	4	Single Real – (IEEE-754) 32 bits (4 bytes per reading)

Power-on *format* = SREAL.

Default *format* = SREAL.

## Important Points

- When using the SINT or DINT memory format, the HP 3457 stores each reading assuming a certain scale factor. This scale factor is based on the present measurement function, range, A/D setting, and enabled math operations. When you recall a reading, the HP 3457 calculates the scale factor based on the present measurement function, range, A/D setting, and enabled math operations. It then multiplies the scale factor times the stored reading and sends the result (recalled reading) to the display or the output buffer. Therefore, always ensure that the HP 3457's configuration is the same when storing and recalling data in the SINT or DINT format.

### NOTE

*Be careful when using autorange when storing data in the DINT or SINT formats. When using autorange, a different scale factor may be applied for each range change. There is no way to recover each scale factor.*

## MFORMAT (cont)

- The memory format does not affect the output format specified by the OFORMAT command.
- Always disable math operations before using the SINT or DINT memory format. When a math operation is enabled (except PFAIL or STAT), the scale factor is 1 and the data may be lost.
- You enable reading memory using the MEM command. You allocate memory space using the MSIZE command. You access stored readings using the RMEM command or by using the “implied read.” The “implied read” is discussed under “Reading Memory” in Chapter 2.

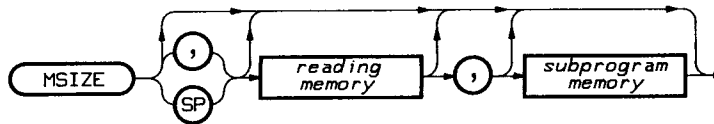
### Example

```
10 OUTPUT 722;"NPLC 10"      ! SELECTS 10 PLCS OF INTEGRATION TIME
20 OUTPUT 722;"DCV 3"       ! SELECTS DC VOLTAGE, 3 V RANGE
30 OUTPUT 722;"MATH OFF"    ! SHUTS-OFF MATH FUNCTIONS
40 OUTPUT 722;"MSIZE 1120"  ! ALLOCATES 1120 BYTES FOR READING MEMORY
50 OUTPUT 722;"MEM FIFO"    ! ENABLES READING MEMORY (FIFO MODE)
60 OUTPUT 722;"MFORMAT DINT" ! SELECTS DINT MEMORY FORMAT
70 END
```

When recalling the stored data, make sure that the HP 3457 is configured as it was when you stored the data. The easiest way to do this is to execute lines 10 through 30 before recalling the data.

The MSIZE (memory size) command clears reading and subprogram memory and allocates memory for reading, subprogram, and state storage.

**Syntax** MSIZE *reading memory,subprogram memory*



## Parameters

*reading memory/  
subprogram memory*

You specify the *reading memory* and *subprogram memory* parameters as the number of bytes of memory you want for each. Any remaining memory is allocated for state storage. Each memory area has a minimum size that you cannot go below. The minimum sizes are:

- Reading memory = 32 bytes minimum
- Subprogram memory = 32 bytes minimum
- State memory = 69 bytes minimum

Power-on *reading memory,subprogram memory* = last specified values.  
Default *reading memory,subprogram memory* = 1000, 100.

## Important Points

- The memory size allocation is stored in non-volatile memory (remains intact after power is removed).
- If you do not specify the reading memory parameter as a multiple of 16, the HP 3457 rounds up to the nearest multiple of 16.
- The HP 3457 allocates reading memory first. If any space is left, it allocates subprogram memory. Finally, it allocates any remaining space to state storage.
- There is a total of 2208 bytes of available memory. If you specify more memory than is available, the HP 3457 flags the PARA. RANGE error (bit 6) and does not alter the existing memory space allocations.
- The amount of space required per reading (reading memory) depends on the memory format. Refer to MFORMAT command.

## MSIZE (cont)

- You can determine the amount of space required for a subprogram (subprogram memory) using the procedure described under “Subprogram Storage” in Chapter 3.
- The amount of state memory reserved for state 0 is 69 bytes. Each additional state requires 69 bytes. For example, to allocate room for one state (location 1), you need 69 bytes + 69 bytes = 138 bytes.

**Example** OUTPUT 722;“MSIZE 800,1000” ! ALLOCATES MEMORY SPACE

The above line allocates 800 bytes (16x50) for reading memory and 1000 bytes for subprogram memory. The remaining 408 bytes are allocated as state memory (enough for states 0 through 4).

The MSIZE? (memory size?) command returns two numbers, separated by a comma, that represent the present memory allocations. The first number is the size of reading memory and the second number is the size of subprogram memory.

## Syntax MSIZE?

MSIZE? →

## Important Points

- The HP 3457 contains 2208 bytes of available memory. You can determine the present size of state memory by adding the returned values of reading and subprogram memory, and subtracting this sum from 2208. This is shown in the example below.
- From the HP 3457's front panel, you execute the MSIZE? command by accessing the MSIZE command from the alphabetic command directory and appending a question mark.
- When you execute the MSIZE? command from the HP 3457's front panel, the response goes to the display. When executed from the controller, the response goes to the HP 3457's output buffer in ASCII format. After executing the MSIZE? command, the output format returns to the previously specified type (SINT, DINT, SREAL, or ASCII).

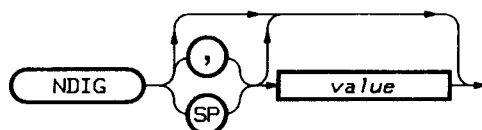
**Example**

```
10 OUTPUT 722;"MSIZE?"           ! RETURNS READING & SUBPROGRAM MEMORY SIZES
20 ENTER 722;A,B                 ! ENTERS SIZES INTO STRING VARIABLES A & B
30 DISP A,B                       ! DISPLAYS SIZES
40 END
```

Assume the above program returns the sizes 32 and 1000. This means there is 32 bytes of reading memory, 1000 bytes of program memory, and 2208 bytes - 1032 bytes = 1176 bytes of state memory (enough for 16 states and state 0).

The NDIG (number of digits) command designates how many digits are shown in the HP 3457's display.

**Syntax** NDIG *value*



## Parameters

*value* For frequency, period, extended ohms measurements, and math operations the *value* parameters and the corresponding number of digits are:

<i>value</i> Parameter	Number of Digits Displayed
3	4
4	5
5	6
6	7

For all other measurements, the *value* parameters and the corresponding number of digits are:

<i>value</i> Parameter	Number of Digits Displayed
3	3.5
4	4.5
5	5.5
6	6.5

Power-on *value* = 5.

Default *value* = 5.

## Important Points

- The NDIG command only affects the display digits. It does not affect the A/D converter's resolution, or readings sent to the HP-IB bus.
- The NDIG command sets the maximum number of digits displayed. The HP 3457 cannot display more digits than are resolved by the A/D converter.

## NDIG (cont)

### Examples

```
10 OUTPUT 722;"FREQ"      ! SELECTS FREQUENCY MEASUREMENTS
20 OUTPUT 722;"NDIG 3"    ! SETS THE NUMBER OF DIGITS TO 4
30 END

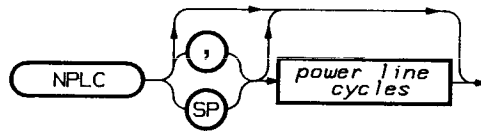
10 OUTPUT 722;"DCV"       ! SELECTS DC VOLTAGE MEASUREMENTS
20 OUTPUT 722;"NDIG 3"    ! SETS THE NUMBER OF DIGITS TO 3.5
30 END
```

# NPLC

- Front Panel
- Remote

The NPLC (number of power line cycles) command designates the minimum integration time for the A/D converter. Integration time is the time, measured in power line cycles (PLCs), during which the HP 3457 samples the input signal.

**Syntax** NPLC *power line cycles*



## Parameters

*power line cycles* The *power line cycles* parameter affects the measurement speed (greater PLCs = slower speed), resolution, and the normal mode rejection. The *power line cycles* choices are:

<i>power line cycles</i> parameter	Digits of Resolution	Normal Mode Rejection
0 - .0005	3.5	0dB
.005	4.5	0dB
.1	5.5	0dB
1	6.5	60dB
10	7.5*	80dB
100	7.5*	90dB

\* To get this resolution, you must access the HIRES math register and add its value to the displayed reading.

Power-on *power line cycles* = 10.  
Default *power line cycles* = .0005.

### NOTE

The power-on value for number of digits (NDIG) is 5. This masks one display digit making the power-on value for PLCs appear to be .1. Set the number of digits to 6 to view the remaining digit.



## NPLC (cont)

### Important Points

- Since resolution is determined by the A/D converter's number of power line cycles (PLCs), an interaction occurs between the NPLC command and the *% resolution* parameter in the function commands (DCV, OHMF, etc.) or the RANGE command. The interaction is as follows:

If you send the NPLC command before the function or RANGE command, the HP 3457 satisfies the command or parameter that designates the most PLCs (greatest resolution).

If you send the NPLC command after the function or RANGE command, the HP 3457 uses the integration time specified by the NPLC command regardless of whether it specifies more or less resolution.

- Typically, you should use the NPLC command to select the required amount of normal mode rejection, and the *% resolution* parameter to select the required resolution. This ensures you will have the required amount of normal mode rejection and at least the required resolution. Refer to "The A/D Converter" in Chapter 3 for an in-depth discussion of integration time and how it affects measurement speed, resolution, and normal mode rejection.
- Only the integral numbers of power line cycles (1, 10, or 100) provide normal mode rejection.

### Examples

```
10 OUTPUT 722;"NPLC .0005"      ! SETS PLCS TO MINIMUM
20 OUTPUT 722;"OHM 600,.0167"  ! SELECTS 2-WIRE OHMS, 600Ω MAX,.0167% RESOLUTION
30 END
```

Line 10 sets the number of PLCs to minimum and allows *% resolution* in line 20 to control the resolution. The resolution specified by line 20 is  $600 \Omega \times .000167 = .1 \Omega$ .

```
10 OUTPUT 722;"NPLC 100"      ! SETS PLCS TO MAXIMUM
20 OUTPUT 722;"OHM 1E3,.01"   ! SELECTS 2-WIRE OHMS, 1kΩ MAX,.01% RESOLUTION
30 END
```

Line 10 sets the number of PLCs to 100. This corresponds to maximum resolution and prevents *% resolution* in line 20 from affecting the measurement. The requested resolution from line 20 is  $1 \text{ k}\Omega \times .0001 = .1 \Omega$ .

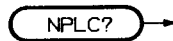
## NPLC (cont)

```
10 OUTPUT 722;"NPLC 100"      ! SETS PLCS TO MAXIMUM
20 OUTPUT 722;"OHM 1E3,.01"   ! SELECTS 2-WIRE OHMS, 1KΩ MAX,.01% RESOLUTION
30 END
```

Line 10 sets the number of PLCs to 100. This corresponds to maximum resolution and prevents *% resolution* in line 20 from affecting the measurement. The requested resolution from line 20 is  $1 \text{ k}\Omega \times .0001 = .1 \text{ }\Omega$ . However, because of line 10, the actual resolution is  $.000001 \text{ }\Omega$ .

The NPLC? (number of power line cycles?) command returns the present number of power line cycles (PLCs) of integration time used by the A/D converter.

## Syntax NPLC?



## Important Points

- From the HP 3457's front panel, you execute the NPLC? command by accessing the NPLC command from the alphabetic command directory and appending a question mark.
- When you execute the NPLC? command from the HP 3457's front panel, the response goes to the display. When executed from the controller, the response goes to the HP 3457's output buffer in ASCII format. After executing the NPLC? command, the output format returns to the previously specified type (SINT, DINT, SREAL, or ASCII).
- Since the number of PLCs can be set by a function command or the RANGE command, it is possible for the NPLC? command to return a greater number of PLCs than was specified by the NPLC command. This is shown in the second example below.

## Examples

```
10 OUTPUT 722;"NPLC?"           ! RETURNS THE PRESENT NUMBER OF PLCS
20 ENTER 722;A                  ! ENTERS RESPONSE INTO VARIABLE A
30 DISP A                       ! DISPLAYS RESPONSE
40 END
```

```
10 OUTPUT 722;"NPLC .0005"      ! SETS PLCS TO A MINIMUM
20 OUTPUT 722;"DCV 3,.0001"     ! SELECTS DCV, 3V RANGE, .0001 % RESOLUTION
30 OUTPUT 722;"NPLC?"          ! RETURNS NUMBER OF PLCS
40 ENTER 722;A                  ! ENTERS RESPONSE INTO VARIABLE A
50 DISP A                       ! DISPLAYS RESPONSE
60 END
```

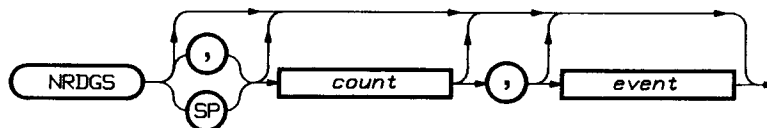
In the above program, line 10 sets the number of PLCs to a minimum (.0005). Line 20, however, selects a DC voltage measurement on the 3 V range with a resolution of .0001%. This specifies an integration time corresponding to 1 PLC. The displayed response (line 50) is 1 PLC.

# NRDGS

- Front Panel
- Remote

The NRDGS (number of readings) command designates the number of readings made per trigger and the event that initiates each reading.

**Syntax** NRDGS *count,event*



## Parameters

***count*** The *count* parameter designates the number of readings per trigger. You specify this parameter as a number from 1 to 32767.

Power-on *count* = 1.

Default *count* = 1.

***event*** The *event* parameter designates the event that initiates a reading. The *event* parameter choices are:

<i>event</i> Parameter	Decimal Equiv.	Description
AUTO	1	Initiates reading whenever the HP 3457 is not busy
EXT	2	Initiates reading on external input
SYN	5	Initiates reading when the HP 3457's output buffer empty, reading memory is off or empty, and the controller requests data.
TIMER	6	Similar to AUTO with a time interval between successive readings. Specify interval with the TIMER command

Power-on *event* = AUTO.

Default *event* = AUTO.

## NRDGS (cont)

### Important Points

- Since the *TIMER event* designates an interval between readings, it only applies when *count* is greater than one. The *TIMER* event disables autoranging. The first reading occurs without the *TIMER* interval. However, you can insert a time interval before the first reading with the *DELAY* command. A complete discussion of *TIMER* and *DELAY* is under “Delay” in Chapter 3.

### Examples

```
10 OUTPUT 722;"TRIG HOLD"           ! SUSPENDS TRIGGERING
20 OUTPUT 722;"DCV 3,.1"           ! SELECTS A DC VOLTAGE MEASUREMENT
30 OUTPUT 722;"TIMER 10"           ! SETS TIMER INTERVAL TO 10 SECONDS
40 OUTPUT 722;"NRDGS 4,TIMER"       ! SELECTS 4 READINGS/TRIGGER & TIMER
50 OUTPUT 722;"TRIG SGL"           ! TRIGGERS ONCE
60 END
```

When you run the above program, the HP 3457 makes 4 readings in response to the single trigger. The first reading is made immediately, the remaining 3 have a 10 second interval between them.

```
10 OUTPUT 722;"DCV 3,.1"           ! SELECTS A DC VOLTAGE MEASUREMENT
20 OUTPUT 722;"NRDGS 3,SYN"        ! SELECTS 3 READINGS/TRIGGER & SYN
30 OUTPUT 722;"MEM OFF"            ! SHUTS READING MEMORY OFF
40 OUTPUT 722;"TRIG AUTO"          ! SELECTS AUTO TRIGGER MODE
50 FOR I = 1 TO 20                  ! CYCLES THROUGH LINES 60 & 70 20 TIMES
60 ENTER 722;A,B,C                 ! READS THE HP 3457's OUTPUT BUFFER
70 DISP A,B,C                       ! DISPLAYS READINGS
80 NEXT I                           ! RETURNS TO LINE 50
90 END
```

In the above program, line 60 requests data from the HP 3457. When the output buffer is empty, this satisfies the *SYN* event and initiates the measurements. The HP 3457 holds the HP-IB bus until the three readings are complete and it can satisfy the request for data. When the output buffer has the three readings, the readings are sent to the controller and displayed. This program displays 60 readings.

# NRDGS?

- Front Panel
- Remote

The NRDGS? (number of readings?) command returns two numbers, separated by a comma, indicating the present measurement configuration. The first number is the specified number of readings per trigger. The second number represents the sample event. The sample events and their numbers are:

```
AUTO = 1
EXT = 2
SYN = 5
TIMER = 6
```

## Syntax NRDGS?



## Important Points

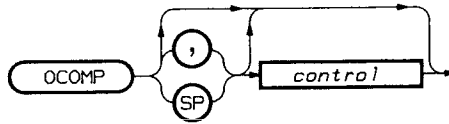
- From the HP 3457's front panel, you execute the NRDGS? command by accessing the NRDGS command from the alphabetic command directory and appending a question mark.
- When you execute the NRDGS? command from the HP 3457's front panel, the response goes to the display. When executed from the controller, the response goes to the HP 3457's output buffer in ASCII format. After executing the NRDGS? command, the output format returns to the previously specified type (SINT, DINT, SREAL, or ASCII).

## Example

```
10 OUTPUT 722;"NRDGS?"           ! RETURNS THE CONFIGURATION RESPONSE
20 ENTER 722;A,B                 ! ENTERS RESPONSE INTO VARIABLES A & B
30 DISP A,B                       ! DISPLAYS RESPONSE
40 END
```

The OCOMP (offset compensation) command enables or disables the offset compensated ohms function.

**Syntax** OCOMP *control*



## Parameters

*control* The *control* parameter choices are:

<i>control</i> Parameter	Decimal Equiv.	Description
OFF	0	Offset compensated ohms disabled.
ON	1	Offset compensated ohms enabled.

Power-on *control* = OFF.  
 Default *control* = ON.

## Important Points

- With offset compensation enabled, the HP 3457 measures the offset voltage before each resistance reading and subtracts it from the following reading. This prevents the offset voltage from affecting the resistance reading but it doubles the time required per reading.
- You can use offset compensated ohms on both 2-wire and 4-wire resistance measurements.
- When you have offset compensation enabled and change from ohms to some other measurement function (DCV, ACV, etc.), offset compensation is temporarily disabled. When you return to 2-wire or 4-wire ohms, however, offset compensation is once again enabled.
- The HP 3457 only performs offset compensation on the 30  $\Omega$ , 300  $\Omega$ , and 3 k $\Omega$  ranges. If OCOMP is enabled on another range, the measurement is made without offset compensation.

**Example** OUTPUT 722;"OCOMP ON" ! ENABLES OFFSET COMPENSATION

# OCOMP?

- Front Panel
- Remote

The OCOMP? (offset compensation?) command returns a number indicating whether offset compensation is on or off: 1 = ON, 0 = OFF.

**Syntax** OCOMP?

OCOMP? →

## Important Points

- From the HP 3457's front panel, you execute the OCOMP? command by accessing the OCOMP command from the alphabetic command directory and appending a question mark.
- When you execute the OCOMP? command from the HP 3457's front panel, the response goes to the display. When executed from the controller, the response goes to the HP 3457's output buffer in ASCII format. After executing the OCOMP? command, the output format returns to the previously specified type (SINT, DINT, SREAL, or ASCII).

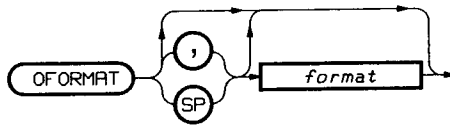
## Example

```
10 OUTPUT 722;"OCOMP?"      ! RETURNS OFFSET COMPENSATION STATE
20 ENTER 722;A              ! ENTERS RESPONSE INTO VARIABLE A
30 DISP A                   ! DISPLAYS RESPONSE
40 END
```



The OFORMAT (output format) command designates the output format for measured readings.

## Syntax OFORMAT *format*



## Parameters

*format* The *format* parameter choices are:

<i>format</i> Parameter	Decimal Equiv.	Description
ASCII	1	ASCII – 14 characters followed by <CR> <LF> (16 bytes per reading)
SINT	2	Single Integer – 16 bits 2's complement (2 bytes per reading)
DINT	3	Double Integer – 32 bits 2's complement (4 bytes per reading)
SREAL	4	Single Real – (IEEE-754) 32 bits, (4 bytes per reading)

Power-on *format* = ASCII.

Default *format* = ASCII.

## Important Points

- The ASCII output format sends a <CR><LF> (carriage return, line feed) on the data bus following any HP-IB data transmission. This indicates the end of the transmission to most computers. The SINT, DINT, and SREAL output formats, however, do not send <CR><LF>. With these formats, you can use the END command to indicate the end of the transmission. Refer to “The Output Buffer” in Chapter 3 for a detailed discussion of the various output formats.
- The output format only applies to measured readings transferred over the HP-IB bus. Responses to query commands are always output in ASCII format regardless of the specified output format. Following the query response, the output format returns to the specified type. The output format does not affect the memory format specified by the MFORMAT command.

## OFORMAT (cont)

- When using the SINT or DINT output formats, the HP 3457 applies a scale factor to each reading. The ISCALE? command returns this scale factor. Retrieve the measured reading from the output buffer before sending the ISCALE? command. If you send the ISCALE? command first, the reading may be destroyed. The scale factor is based on the present measurement function, range, A/D setting, and enabled math operations. When you send the ISCALE? command, the HP 3457 returns a scale factor based on the present measurement function, range, A/D setting, and enabled math operations. Therefore, ensure that the HP 3457's configuration is the same when making measurements as it is when you retrieve the scale factor.
- When using autorange and the DINT or SINT output format, a different scale factor may be applied for each range change. Tables 3-11 and 3-12 show the scale factors for all ranges in the SINT and DINT output formats.
- When a math operation is enabled (except PFAIL or STAT) the scale factor is always 1. When using the SINT or DINT format with one or more of these math operations enabled, you will be unable to use the ISCALE? command to retrieve the correct scale factor. Use Table 3-11 or 3-12 to determine the scale factor. When the PFAIL or STAT math operation is enabled, the correct scale factor can be retrieved using the ISCALE? command.

## OFORMAT (cont)

### Examples

```
DINT Format 10 OUTPUT 722;"DCV"           ! SELECTS DC VOLTAGE MEASUREMENTS
                20 OUTPUT 722;"OFORMAT DINT"       ! SELECTS THE DINT OUTPUT FORMAT
                30 OUTPUT 722;"TRIG SGL"           ! TRIGGERS ONE MEASUREMENT
                40 ENTER 722 USING "#,B" ; A,B,C,D  ! ENTERS READING INTO A,B,C,D VARIABLES
                50 T=A*16777216+B*65536+C*256+D! CONVERTS READING
                60 IF A>127 THEN T=T-4294967296     ! CORRECTS NEGATIVE READING
                70 OUTPUT 722;"ISCALE?"           ! RETURNS SCALE FACTOR
                80 ENTER 722;I                     ! STORES SCALE FACTOR IN I VARIABLE
                90 R=T*I                           ! MULTIPLIES CONVERTED READING TIMES
                                                    SCALE FACTOR
                100 DISP R                         ! DISPLAYS READING IN VOLTS
                110 END
```

In the above program, the reading is entered into the A, B, C, and D variables using the image specifiers # and B (line 40). The # image specifier suppresses the need for <CR> <LF> (carriage return, line feed ) following the data transmission. This prevents the computer from interpreting <CR> <LF> as binary data. The B image specifier, enters the reading in four 8-bit binary bytes. Each byte is put into a separate integer variable.

```
SINT Format 10 OUTPUT 722;"DCV"           ! SELECTS DC VOLTAGE MEASUREMENTS
                20 OUTPUT 722;"OFORMAT SINT"       ! SELECTS THE SINT OUTPUT FORMAT
                30 OUTPUT 722;"TRIG SGL"           ! TRIGGERS ONE MEASUREMENT
                40 ENTER 722 USING "#,W";A         ! ENTERS READING INTO A VARIABLE
                50 OUTPUT 722;"ISCALE?"           ! RETURNS SCALE FACTOR
                60 ENTER 722;I                     ! STORES SCALE FACTOR IN I VARIABLE
                70 R=A*I                           ! MULTIPLIES READING TIMES SCALE FACTOR
                80 DISP R                         ! DISPLAYS READING IN VOLTS
                90 END
```

In the above program, the reading is entered into the A variable using the image specifiers # and W (line 40). The # image specifier suppresses the need for <CR> <LF> (carriage return, line feed ) following the data transmission. This prevents the computer from interpreting <CR> <LF> as binary data. The W image specifier, enters the reading in two 8-bit bytes. These two bytes are entered into a single variable (A) as a 2's complement integer.

## OFORMAT (cont)

```
SREAL Format 10 OUTPUT 722;"DCV"           ! SELECTS DC VOLTAGE MEASUREMENTS
                20 OUTPUT 722;"OFORMAT SREAL" ! SELECTS SREAL OUTPUT FORMAT
                30 OUTPUT 722;"TRIG SGL"      ! TRIGGERS ONE READING
                40 S=1                        ! SETS S VARIABLE TO 1
                50 ENTER 722 USING "#,B";A,B,C,D ! ENTERS READING INTO A,B,C,D VARIABLES
                60 IF A>127 THEN S = -1       ! CONVERTS READING
                70 IF A>127 THEN A = A-128    ! CONVERTS READING
                80 A=A*2-127                  ! CONVERTS READING
                90 IF B>127 THEN A = A+1      ! CONVERTS READING
                100 IF B≤127 THEN B=B+128     ! CONVERTS READING
                110 R=S*(B*65536+C*256+D)*2 (A-23) ! CONVERTS READING
                120 DISP R                    ! DISPLAYS READING
                130 END
```

In the above program, the reading is entered into the A, B, C, and D variables using the image specifiers # and B (line 50). The # image specifier suppresses <CR> <LF> (carriage return, line feed) following the data transmission. This prevents the computer from interpreting <CR> <LF> as binary data. The B image specifier, outputs the reading in four 8-bit bytes.

When using the above program, the conversion produces more digits than were resolved by the HP 3457's A/D converter. Round the final reading so that it contains the same number of digits. For example, assume the A/D converter is resolving 6.5 digits and the above program produced:

-0.758229970932

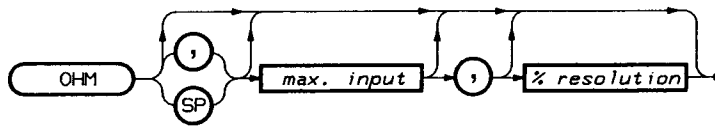
You should round to:

-0.758230

For more information, refer to "The A/D Converter" in Chapter 3.

The OHM command instructs the HP 3457 to measure 2-wire ohms. It also allows you to specify the measurement range and resolution.

**Syntax** OHM *max. input*, % *resolution*



## Parameters

***max. input*** The *max. input* parameter selects one of eight standard ranges or the autorange mode. To select a standard range, you specify *max. input* as the maximum expected resistance reading.

To select the autorange mode, specify AUTO for *max. input* or default the parameter. In the autorange mode, the HP 3457 samples the input signal before each measurement and selects the appropriate range.

The *max. input* choices are:

<i>max. input</i> Parameters	Selects Range	Full Scale Reading
-1 or AUTO	Autorange	
0 - 30	30 $\Omega$	30.3 $\Omega$
>30 - 300	300 $\Omega$	303 $\Omega$
>300 - 3E3	3 k $\Omega$	3.03 k $\Omega$
>3E3 - 3E4	30 k $\Omega$	30.3 k $\Omega$
>3E4 - 3E5	300 k $\Omega$	303 k $\Omega$
>3E5 - 3E6	3 M $\Omega$	3.03 M $\Omega$
>3E6 - 3E7	30 M $\Omega$	30.3 M $\Omega$
>3E7 - 3E9	3 G $\Omega$	3.03 G $\Omega$

Power-on *max. input* = none.

Default *max. input* = AUTO.

## OHM (cont)

*% resolution* You specify the *% resolution* parameter as a percentage of the *max. input* parameter. The HP 3457 then multiplies *% resolution* times *max. input* to determine the measurement's resolution.

For example, suppose your maximum expected input is 10 k $\Omega$  and you want 1  $\Omega$  of resolution. To determine *% resolution*, use the equation:

$$\% \text{ resolution} = (\text{actual resolution}/\text{maximum input}) \times 100$$

For this example, the equation evaluates to:

$$\% \text{ resolution} = (1/10000) \times 100 = .0001 \times 100 = .01$$

---

### NOTE

*When using autorange, the HP 3457 multiplies the % resolution parameter times the full scale reading of the selected range. The result is the minimum resolution. The HP 3457 always gives you at least the minimum resolution and, in many cases, it gives you an additional digit of resolution.*

---

Power-on *% resolution* = none.

Default *% resolution* = determined by the integration time specified in the NPLC command.

## Important Points

- The power-on value for number of digits (NDIG) is 5. This masks one display digit. Set the number of digits to 6 to view the remaining digit.
- From the front panel, you select 2-wire ohms measurements using the OHM key or by accessing the FUNC command from the alphabetic command directory. The OHM key does not allow you to select any additional parameters. With the FUNC command, you can specify the measurement range and resolution.
- The HP 3457 changes the measurement resolution by changing the amount of time during which it samples the input signal (integration time). Both the *% resolution* parameter and the NPLC command affect the integration time. When you execute a function command (ACV, DCV, OHM, etc.) the HP 3457 compares the integration time specified

## OHM (cont)

by *% resolution* to that specified by the NPLC command. The HP 3457 then uses the parameter or command that specifies the longest integration time (most resolution). Since the NPLC command's power-on value is 10 PLCs, you must lower the number of PLCs to get less resolution (this is shown in the first and second examples below).

- The 3 G $\Omega$  range is called the extended ohms range and is a combination of two ranges; the 300 M $\Omega$  range and the 3 G $\Omega$  range.

### Examples

```
10 OUTPUT 722;"NPLC .0005"      ! SETS PLCS TO MINIMUM
20 OUTPUT 722;"OHM 600,.0167"    ! SELECTS 2-WIRE OHMS, 600 $\Omega$  MAX,.0167%
                                RESOLUTION
30 END
```

In the above program, line 10 allows *% resolution* in line 20 to control the resolution. The resolution specified by line 20 is  $600 \Omega \times .000167 = .1 \Omega$ .

```
10 OUTPUT 722;"NPLC .0005"      ! SETS PLCS TO MINIMUM
20 OUTPUT 722;"OHM AUTO,.033"    ! SELECTS 2-WIRE OHMS, AUTORANGE, .033%
                                RESOLUTION
30 END
```

In the above program, line 10 allows *% resolution* in line 20 to control the resolution. In this example, the HP 3457 provides at least .033% resolution for full scale readings on whatever range autorange selects.

```
10 OUTPUT 722;"NPLC 100"        ! SETS PLCS TO MAXIMUM
20 OUTPUT 722;"OHM 1E3,.01"     ! SELECTS 2-WIRE OHMS, 1K $\Omega$  MAX,.01%
                                RESOLUTION
30 END
```

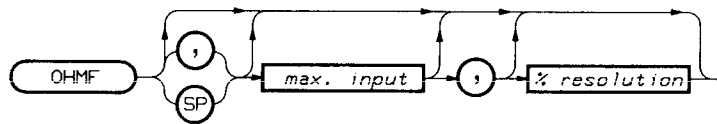
In the above program, line 10 sets the number of PLCs to 100. This corresponds to maximum resolution and prevents *% resolution* in line 20 from affecting the measurement. The requested resolution from line 20 is  $1 \text{ k}\Omega \times .0001 = .1 \Omega$ . However, because of line 10, the actual resolution is  $.000001 \Omega$ .

# OHMF

□ Front Panel  
■ Remote

The OHMF (4-wire ohms) command instructs the HP 3457 to measure 4-wire ohms. It also allows you to specify the measurement range and resolution.

**Syntax** OHMF *max. input*, % *resolution*



## Parameters

***max. input*** The *max. input* parameter selects one of eight standard ranges or the autorange mode. To select a standard range, you specify *max. input* as the maximum expected resistance reading. The HP 3457 then selects the appropriate range.

To select the autorange mode, specify AUTO for *max. input* or default the parameter. In the autorange mode, the HP 3457 samples the input signal before each measurement and selects the appropriate range.

The *max. input* choices are:

<i>max. input</i> Parameters	Selects Range	Full Scale Reading
-1 or AUTO	Autorange	
0 - 30	30 $\Omega$	30.3 $\Omega$
>30 - 300	300 $\Omega$	303 $\Omega$
>300 - 3E3	3 k $\Omega$	3.03 k $\Omega$
>3E3 - 3E4	30 k $\Omega$	30.3 k $\Omega$
>3E4 - 3E5	300 k $\Omega$	303 k $\Omega$
>3E5 - 3E6	3 M $\Omega$	3.03 M $\Omega$
>3E6 - 3E7	30 M $\Omega$	30.3 M $\Omega$
>3E7 - 3E9	3 G $\Omega$	3.03 G $\Omega$

Power-on *max. input* = none.

Default *max. input* = AUTO.



## OHMF (cont)

**% resolution** You specify the *% resolution* parameter as a percentage of the *max. input* parameter. The HP 3457 then multiplies *% resolution* times *max. input* to determine the measurement's resolution.

For example, suppose your maximum expected input is 10 k $\Omega$  and you want 1  $\Omega$  of resolution. To determine *% resolution*, use the equation:

$$\% \text{ resolution} = (\text{actual resolution}/\text{maximum input}) \times 100$$

For this example, the equation evaluates to:

$$\% \text{ resolution} = (1/10000) \times 100 = .0001 \times 100 = .01$$

---

### NOTE

*When using autorange, the HP 3457 multiplies the % resolution parameter times the full scale reading of the selected range. The result is the minimum resolution. The HP 3457 always gives you at least the minimum resolution and, in many cases, it gives you an additional digit of resolution.*

---

Power-on *% resolution* = none.

Default *% resolution* = determined by the integration time specified in the NPLC command.

## Important Points

- The power-on value for number of digits (NDIG) is 5. This masks one display digit. Set the number of digits to 6 to view the remaining digit.
- From the front panel, you select 4-wire ohms measurements using the shifted OHMF key or by accessing the FUNC command from the alphabetic command directory. The OHMF key does not allow you to select any additional parameters. With the FUNC command, you can specify the measurement range and resolution.

## OHMF (cont)

- The HP 3457 changes the measurement resolution by changing the amount of time during which it samples the input signal (integration time). Both the *% resolution* parameter and the NPLC command affect the integration time. When you execute a function command (ACV, DCV, OHM, etc.) the HP 3457 compares the integration time specified by *% resolution* to that specified by the NPLC command. The HP 3457 then uses the parameter or command that specifies the longest integration time (most resolution). Since the NPLC command's power-on value is 10 PLCs, you must lower the number of PLCs to get less resolution (this is shown in the first and second examples below).
- The 3 G $\Omega$  range is called the extended ohms range and is a combination of two ranges; the 300 M $\Omega$  range and the 3 G $\Omega$  range.

### Examples

```
10 OUTPUT 722;"NPLC .0005"           ! SETS PLCS TO MINIMUM
20 OUTPUT 722;"OHMF 600,.0167"       ! SELECTS 4-WIRE OHMS, 600 $\Omega$  MAX,.0167%
                                     RESOLUTION
30 END
```

In the above areas, line 10 allows *% resolution* in line 20 to control the resolution. The resolution specified by line 20 is  $600 \Omega \times .000167 = .1 \Omega$ .

```
10 OUTPUT 722;"NPLC .0005"           ! SETS PLCS TO MINIMUM
20 OUTPUT 722;"OHMF AUTO,.033"       ! SELECTS 4-WIRE OHMS, AUTORANGE, .033%
                                     RESOLUTION
30 END
```

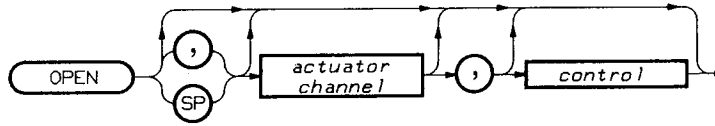
In the above areas, line 10 allows *% resolution* in line 20 to control the resolution. In this example, the HP 3457 provides at least .033% resolution for full scale readings on whatever range autorange selects.

```
10 OUTPUT 722;"NPLC 100"             ! SETS PLCS TO MAXIMUM
20 OUTPUT 722;"OHMF 1E3,.01"         ! SELECTS 4-WIRE OHMS, 1K $\Omega$  MAX,.01%
                                     RESOLUTION
30 END
```

In the above areas, line 10 sets the number of PLCs to 100. This corresponds to maximum resolution and prevents *% resolution* in line 20 from affecting the measurement. The requested resolution from line 20 is  $1 \text{ k}\Omega \times .0001 \Rightarrow .1 \Omega$ . However, because of line 10, the actual resolution is .000001  $\Omega$ .

The OPEN command opens actuator channel 8 or 9 on the HP 44491 plug-in card.

**Syntax** OPEN *actuator channel,control*



## Parameters

***actuator channel*** You specify the *actuator channel* parameter as the number of the channel you want to open (8 or 9).

Power-on *actuator channel* = all open.  
 Default *actuator channel* = 8.

***control*** The *control* parameter enables or disables a 1.2 second delay. When enabled, the delay occurs after the actuator opens and prevents the actuator from closing (CLOSE command or scan advance) until the delay period is over. This prevents possible relay damage caused by switching maximum or near maximum loads too fast. The *control* parameter choices are:

<i>control</i> Parameter	Decimal Equiv.	Description
OFF	0	No delay occurs
ON	1	Adds 1.2 second delay after every actuator opening

Power-on *control* = OFF.  
 Default *control* = ON.

### CAUTION

*To prevent contact damage, use the delay if you are repeatedly switching currents greater than 25mA.*

## OPEN (cont)

### Important Points

- You do not need to select the HP 44491 as the input source (TERM command) to open or close an actuator channel.
- If you execute the OPEN command without an HP 44491 in the HP 3457's rear slot, you'll get the BAD HEADER error.

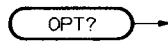
### Example

```
10 OUTPUT 722;"CLOSE 8"           ! CLOSSES CHANNEL 8
20 OUTPUT 722;"OPEN 8,ON"         ! OPENS CHANNEL 8 WITH DELAY
30 OUTPUT 722;"CLOSE 8"           ! CLOSSES CHANNEL 8
40 END
```

The OPT? (option?) command returns a number representing the type of device in the HP 3457's rear slot. The possible numbers are:

- 0 = rear terminals or nothing in rear slot
- 44491 = HP 44491 General Purpose Card
- 44492 = HP 44492 Multiplexer Card

## Syntax OPT?



## Important Points

- If you execute OPT? from the HP 3457's front panel, the response goes to the display. If you execute OPT? from the controller, the response goes to the HP 3457's output buffer in ASCII format after which the output format returns to the previously specified type (SINT, DINT, SREAL, or ASCII).

## Example

```
10 OUTPUT 722;"OPT?"           ! RETURNS DEVICE NUMBER RESPONSE
20 ENTER 722;A                 ! ENTERS RESPONSE INTO VARIABLE A
30 DISP A                      ! DISPLAYS RESPONSE
40 END
```

# PAUSE

Front Panel

Remote

The HP 3457 executes subprograms on a command-by-command basis. When it encounters the PAUSE command, it suspends subprogram execution. Subprogram execution is resumed only when the HP-IB Group Execute Trigger (GET) is received.

## Syntax PAUSE



## Important Points

- If a Group Execute Trigger occurs during subprogram execution, but before the PAUSE command is encountered, it prevents the subsequent PAUSE command from suspending subprogram execution.
- When you call a subprogram using the standard format (e.g., OUTPUT 722;"CALL 1"), the computer sends <CR><LF> (carriage return, line feed) on the data bus following the CALL command. The HP 3457 processes the <CR> immediately but does not process the <LF> until the subprogram is executed. This means that, because of the <LF>, the HP 3457 holds the HP-IB bus until the subprogram is executed. If a PAUSE command is in the subprogram, subprogram execution ceases and the HP-IB bus remains held. This means you cannot regain control of the computer to send the Group Execute Trigger. You can prevent this by suppressing <CR><LF> when sending the CALL command. The example below shows how to use image specifiers (#, K) to suppress <CR><LF> when sending the CALL command.

## Example

```
10 OUTPUT 722;"MSIZE 200,1000"    ! ALLOCATES MEMORY
20 OUTPUT 722;"SUB 1"             ! STORES LINES 30-120 AS SUBPROGRAM #2
30 OUTPUT 722;"TRIG HOLD"        ! SUSPENDS TRIGGERING
40 OUTPUT 722;"MEM FIFO"         ! ENABLES READING MEMORY, FIFO MODE
50 OUTPUT 722;"OHM"              ! SELECTS 2-WIRE OHMS MEASUREMENTS
60 OUTPUT 722;"NRDGS 5"         ! SELECTS 5 READINGS PER TRIGGER
70 OUTPUT 722;"TRIG SGL"        ! GENERATES A SINGLE TRIGGER
80 OUTPUT 722;"PAUSE"           ! SUSPENDS PROGRAM EXECUTION
90 OUTPUT 722;"ACV"              ! SELECTS AC VOLTAGE MEASUREMENTS
100 OUTPUT 722;"NRDGS 10"       ! SELECTS 10 READINGS PER TRIGGER
110 OUTPUT 722;"TRIG SGL"       ! GENERATES A SINGLE TRIGGER
120 OUTPUT 722;"SUBEND"         ! SIGNIFIES THE END OF THE SUBPROGRAM
130 END
```

## PAUSE (cont)

When you call the above subprogram, the HP 3457 executes the subprogram line by line. Lines 20 through 70 cause the HP 3457 to make five 2-wire ohms measurements and place the results in reading memory. When line 80 is encountered, subprogram execution ceases. A subsequent Group Execute Trigger resumes program execution. After receiving a Group Execute Trigger, lines 90 through 110 cause the HP 3457 to make 10 AC voltage measurements and place the results in reading memory. When the subprogram is finished, a total of 15 readings are in memory.

You call the above subprogram by executing the following line:

```
OUTPUT 722 USING "#,K";"CALL 1;"
```

---

### NOTE

*In the above line, the # image specifier suppresses the <CR> <LF>. The K image specifier suppresses trailing or leading spaces and outputs the command in free-field format. Notice the semicolon following the CALL 1. This indicates the end of the command to the HP 3457 and must be present when you suppress <CR> <LF>.*

---

After the five 2-wire ohms measurements are complete, connect an AC voltage source to the HP 3457 and resume subprogram execution by sending:

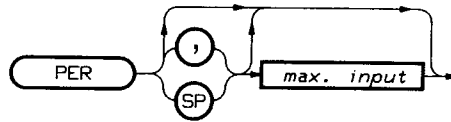
```
TRIGGER 7
```

# PER

Front Panel  
 Remote

The PER (period) command instructs the HP 3457 to measure period. It also allows you to specify the amplitude range of the input signal.

**Syntax** PER *max. input*



## Parameters

*max. input*

### NOTE

The *max. input* parameter selects the amplitude range of the input signal not the period range (seconds).

The *max. input* parameter selects a standard range or the autorange mode. To select a standard range, you specify the *max. input* as the maximum expected amplitude of the input signal. The HP 3457 then selects the correct range.

To select autorange, specify AUTO for *max. input* or default the parameter. In the autorange mode, the HP 3457 samples the input signal before each measurement and selects the appropriate range.

The *max. input* choices are:

For AC or AC + DC Voltage:

<i>max. input</i> Parameter	Selects Range
-1 or AUTO	Autorange
0 - .03	30 mV
>.03 - .3	300 mV
>.3 - 3	3 V
>3 - 30	30 V
>30 - 300	300 V

For AC or AC + DC Current

<i>max. input</i> Parameter	Selects Range
-1 or AUTO	Autorange
0 - .03	30 mA
>.03 - .3	300 mA
>.3 - 1	1 A

Power-on *max. input* = none.  
Default *max. input* = AUTO.



## PER (cont)

### Important Points

- You use the PER command along with the FSOURCE command. The FSOURCE command designates whether the input signal is AC voltage, AC+DC voltage, AC current, or AC + DC current.
- From the front panel, you select period measurements by using the shifted PER key or by accessing the FUNC command from the alphabetic command directory. The shifted PER key does not allow you to select any additional parameters. With the FUNC command, you can specify the measurement range.
- Seven digits of resolution are always provided for period measurements regardless of the specified amount of integration time (NPLC command). The integration time does, however, affect the measurement speed (the greater the integration time, the slower the measurements).

### Example

```
10 OUTPUT 722;"FSOURCE ACI"    ! SELECTS AC CURRENT AS INPUT SOURCE
20 OUTPUT 722;"PER .03"        ! SELECTS PERIOD MEASUREMENT ON THE 30mA RANGE
30 END
```

# PRESET

- Front Panel
- Remote

The PRESET command configures the HP 3457 to a predefined state. This command is primarily for remote operation and selects a good starting point for remote operation.

## Syntax PRESET



## Important Points

- The PRESET command executes the following commands:

ACBAND 20	MEM OFF (last memory operation set to FIFO)
AZERO ON	MFORMAT SREAL
BEEP ON	NDIG 5
CRESET	NPLC 1
DCV AUTO	NRDGS 1,AUTO
DELAY -1	OCOMP OFF
DISP ON	OFORMAT ASCII
FIXEDZ OFF	SADV HOLD
F SOURCE ACV	SADV HOLD
INBUF OFF	SLIST (empty list)
LOCK OFF	TARM AUTO
MATH OFF,OFF	TERM FRONT
All math registers set to 0 except:	TIMER 1
DEGREE = 20	TRIG SYN
PERC = 1	
REF = 1	
RES = 50	
SCALE = 1	

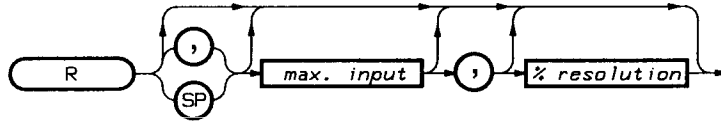
- It is a good idea to include the PRESET command at the beginning of your programs to initialize the HP 3457. The PRESET command initializes the HP 3457 much faster than the RESET command.

**Example** OUTPUT 722;"PRESET" ! PRESETS THE HP 3457

---

The R command is an abbreviation of the RANGE command. Except for the syntax, the R and RANGE commands are identical. Refer to RANGE (following page) for details.

**Syntax** R *max. input*, % *resolution*

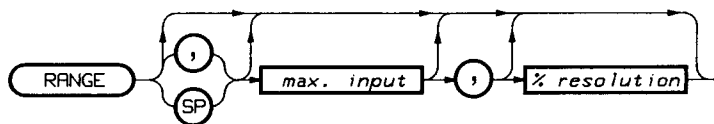


# RANGE

- Front Panel
- Remote

The RANGE command allows you to select a measurement range or the autorange mode. You can abbreviate this command with an R.

**Syntax** RANGE *max. input*, % resolution



## Parameters

***max. input*** The *max. input* parameter selects a standard range or the autorange mode. To select a standard range, you specify the *max. input* as the maximum expected amplitude of the input signal. The HP 3457 then selects the correct range.

To select the autorange mode, specify AUTO for *max. input* or default the parameter. In the autorange mode, the HP 3457 samples the input signal before each measurement and selects the appropriate range.

The *max. input* choices are:

For AC Voltage Measurements:

<i>max. input</i> Parameter	Selects Range	Full Scale Reading
-1 or AUTO	Autorange	
0 - .03	30 mV	32.5 mV
>.03 - .3	300 mV	325 mV
>.3 - 3	3 V	3.25 V
>3 - 30	30 V	32.5 V
>30 - 300	300 V	303 V

For DC Voltage Measurements:

<i>max input</i> Parameter	Selects Range	Full Scale Reading
-1 or AUTO	Autorange	
0 - .03	30 mV	30.3 mV
>.03 - .3	300 mV	303 mV
>.3 - 3	3 V	3.03 V
>3 - 30	30 V	30.3 V
>30 - 300	300 V	303 V

For AC Current Measurements:

<i>max. input</i> Parameter	Selects Range	Full Scale Reading
-1 or AUTO	Autorange	
> 0 - .03	30 mA	32.5 mA
>.03 - .3	300 mA	325 mA
>.3 - 1	1 A	1.05 A

For DC Current Measurements:

<i>max input</i> Parameter	Selects Range	Full Scale Reading
-1 or AUTO	Autorange	
>0 - .0003	300 $\mu$ A	303 $\mu$ A
>.0003 - .003	3 mA	3.03 mA
>.003 - .03	30 mA	30.3 mA
>.03 - .3	300 mA	303 mA
>.3 - 1.5	1.5 A	1.5 A

## RANGE (cont)

For All Ohms Measurements:

<i>max. input</i> Parameter	Selects Range	Full Scale Reading
-1 or AUTO	Autorange	
0 - 30	30 $\Omega$	30.3 $\Omega$
>3 - 300	300 $\Omega$	303 $\Omega$
>300 - 3E3	3 k $\Omega$	3.03 k $\Omega$
>3E3 - 3E4	30 k $\Omega$	30.3 k $\Omega$
>3E4 - 3E5	300 k $\Omega$	303 k $\Omega$
>3E5 - 3E6	3 M $\Omega$	3.03 M $\Omega$
>3E6 - 3E7	30 M $\Omega$	30.3 M $\Omega$
>3E7 - 3E9	3 G $\Omega$	3.03 G $\Omega$

Power-on *max. input* = AUTO.

Default *max. input* = AUTO.

***% resolution*** You specify the *% resolution* parameter as a percentage of the *max. input* parameter. The HP 3457 then multiplies *% resolution* times *max. input* to determine the measurement's resolution.

For example, suppose your maximum expected input is 10 k $\Omega$  and you want 1  $\Omega$  of resolution. To determine *% resolution*, use the equation:

$$\% \text{ resolution} = (\text{actual resolution}/\text{maximum input}) \times 100$$

For this example, the equation evaluates to:

$$\% \text{ resolution} = (1/10000) \times 100 = .0001 \times 100 = .01$$

---

### NOTE

*When using autorange, the HP 3457 multiplies the % resolution parameter times the full scale reading of the selected range. The result is the minimum resolution. The HP 3457 always gives you at least the minimum resolution and, in many cases, it gives you an additional digit of resolution.*

---

Power-on *% resolution* = determined by the integration time specified by the NPLC command (power-on value for NPLC = 10).

Default *% resolution* = determined by the integration time specified by the NPLC command (power-on value for NPLC = 10).

## RANGE (cont)

### Important Points

- The power-on value for number of digits (NDIG) is 5. This masks one display digit. Set the number of digits to 6 to view the remaining digit.
- The HP 3457 changes the measurement resolution by changing the amount of time during which it samples the input signal (integration time). Both the *% resolution* parameter and the NPLC command affect the integration time. When you execute the RANGE command, the HP 3457 compares the integration time specified by *% resolution* to that specified by the NPLC command. The HP 3457 then uses the parameter or command that specifies the longest integration time (most resolution). Since the NPLC command's power-on value is 10 PLCs, you must lower the number of PLCs to get less resolution (this is shown in the first and second examples below).

### Examples

```
10 OUTPUT 722;"NPLC .0005"           ! SETS PLCS TO MINIMUM
20 OUTPUT 722;"OHM"                   ! SELECTS 2-WIRE OHMS
30 OUTPUT 722;"RANGE 600,.0167"      ! SELECTS 600Ω MAX,.0167% RESOLUTION
40 END
```

In the above program, line 10 allows *% resolution* in line 30 to control the resolution. The resolution specified by line 30 is  $600 \Omega \times .000167 = .1 \Omega$ .

```
10 OUTPUT 722;"NPLC .0005"           ! SETS PLCS TO MINIMUM
20 OUTPUT 722;"DCV"                   ! SELECTS DC VOLTAGE MEASUREMENTS
30 OUTPUT 722;"RANGE AUTO,.033"      ! AUTORANGE,.033% RESOLUTION
40 END
```

In the above program, line 10 allows *% resolution* in line 30 to control the resolution. In this example, the HP 3457 provides at least .033% resolution for full scale readings on whatever range autorange selects.

```
10 OUTPUT 722;"NPLC 100"              ! SETS PLCS TO MAXIMUM
20 OUTPUT 722;"OHM"                   ! SELECTS 2-WIRE OHMS MEASUREMENTS
30 OUTPUT 722;"R 1E3,.01"             ! SELECTS 1 kΩ MAX,.1% RESOLUTION
40 END
```

In the above program, line 10 sets the number of PLCs to 100. This corresponds to maximum resolution and prevents *% resolution* in line 30 from affecting the measurement. The requested resolution from line 30 is  $1 \text{ k}\Omega \times .0001 = .1 \Omega$ . However, because of line 10, the actual resolution is  $.000001 \Omega$ . In line 30, the abbreviation (R) for the RANGE command is used.

The RANGE? command returns a number representing the present measurement range. Refer to the RANGE command on the previous page for a listing of the possible ranges for all measurement functions.

## Syntax RANGE?



## Important Points

- From the HP 3457's front panel, you execute the RANGE? command by accessing the RANGE command from the alphabetic command directory and appending a question mark.
- When you execute the RANGE? command from the HP 3457's front panel, the response goes to the display. When executed from the controller, the response goes to the HP 3457's output buffer in ASCII format. After executing the RANGE? command, the output format returns to the previously specified type (SINT, DINT, SREAL, or ASCII).

## Example

```
10 OUTPUT 722;"RANGE?"      ! RETURNS MEASUREMENT RANGE
20 ENTER 722;A              ! ENTERS RESPONSE INTO VARIABLE A
30 DISP A                   ! DISPLAYS RESPONSE
40 END
```

# RESET

- Front Panel
- Remote

The RESET command allows you to set the HP 3457 to the power-on state without cycling power.

## Syntax

RESET



## Important Points

- The RESET command does the following:

- Aborts readings in process.
- Clears error and auxiliary error registers.
- Clears the status register except the Power-on SRQ bit (bit 3).
- Checks the security code.
- Measures line frequency and uses this value for the A/D converter reference.
- Clears reading and subprogram memory.

In addition, the RESET command also executes these commands:

ACBAND 20	MEM OFF (last memory operation set to FIFO)
AZERO ON	MFORMAT SREAL
CRESET	NDIG 5
DCV AUTO	NPLC 10
DELAY -1	NRDGS 1,AUTO
DISP ON	OCOMP OFF
END OFF	OFORMAT ASCII
FIXEDZ OFF	SADV HOLD
FSOURCE ACV	SLIST (empty list)
INBUF OFF	TARM AUTO
LOCK OFF	TERM FRONT
MATH OFF,OFF	TIMER 1
All math registers set to 0 except:	TRIG AUTO
DEGREE = 20	
SCALE = 1	
PERC = 1	
REF = 1	
RES = 50	



## RESET (cont)

- The RESET command can be used from remote although it is primarily for front panel use. The RESET command configures the HP 3457 to a good starting point for local operation.
- When attempting to send the RESET command from remote, it is possible that the HP 3457 is busy or the HP-IB bus is being held. In either case, the HP 3457 will not immediately respond to the remote RESET command. For this reason, you should send the HP-IB device clear command before you send the HP 3457's RESET command. This is shown in the example below.

### Example

```
10 CLEAR 722                ! CLEARS THE HP 3457 IMMEDIATELY
20 OUTPUT 722;"RESET"      ! RESETS THE HP 3457
30 END
```

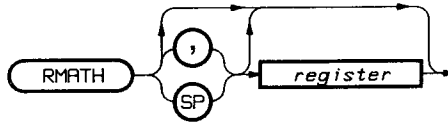
# REV?

- Front Panel
  - Remote
- 

This is a service related command. Refer to the HP 3457 service manual for details.

The RMATH (recall math) command reads and returns the contents of a math register.

**Syntax** RMATH *register*



## Parameters

*register* The *register* parameter choices are:

<i>register</i> Parameter	Decimal Equiv.	Register Contents
DEGREE	1	Time constant for FILTER and RMS
LOWER	2	Smallest reading in STATS
MAX	3	Upper limit for PFAIL operation
MEAN	4	Average of readings in STATS
MIN	5	Lower limit for PFAIL
NSAMP	6	Number of samples in STATS
OFFSET	7	Subtrahend in NULL and SCALE operations
PERC	8	% value for PERC operation
REF	9	Reference value for DB operation
RES	10	Reference impedance for DBM operation
SCALE	11	Divisor in the SCALE operation
SDEV	12	Standard deviation in STATS
UPPER	13	Largest reading in STATS
HIRES	14	Extra digit for measurements made with NPLC set to 10 or 100

Power-on *register* = none.

Default *register* = DEGREE.

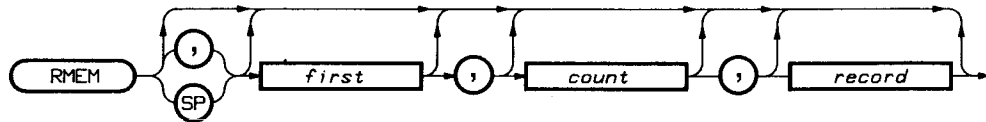
## RMATH (cont)

<b>Example</b>	10 OUTPUT 722;"TRIG HOLD"	! SUSPENDS TRIGGERING
	20 OUTPUT 722;"NPLC 100"	! SETS PLCS TO 100 (MAXIMUM RESOLUTION)
	30 OUTPUT 722;"DCV 3"	! SELECTS DC VOLTAGE, 3 V RANGE
	40 OUTPUT 722;"TRIG SGL"	! TRIGGERS THE HP 3457 ONCE
	50 ENTER 722;A	! ENTERS 6.5 DIGIT READING INTO COMPUTER'S A VARIABLE
	60 OUTPUT 722;"RMATH HIRES"	! READS THE HIRES MATH REGISTER
	70 ENTER 722;B	! ENTERS HIRES CONTENTS INTO COMPUTER'S B VARIABLE
	80 C=A+B	! ADDS HIRES TO 6.5 DIGIT READING
	90 DISP C	! DISPLAYS SUM
	100 END	

The above program allows you to get one more digit of resolution by consulting HIRES register and adding its contents to the reading. You can do this only when the number of power line cycles (PLCs) is set to 10 or 100. This program produces more digits of resolution than are being resolved by the A/D converter. Correct the result by rounding it to 7.5 digits.

The RMEM (recall memory) command reads and returns the value of a particular reading or group of readings from reading memory. This command leaves stored readings intact—it does not destroy (clear) readings.

**Syntax** RMEM *first,count,record*



## Parameters

- first*** The *first* parameter designates the beginning reading.
- count*** The *count* parameter designates the number of readings to be recalled, starting with *first*.
- record*** The *record* parameter designates the record from which you want to recall readings. Records correspond to the number of readings you have specified with the NRDGS command. For example, if you have specified three readings in the NRDGS command, each record contains three readings.

Power-on *first,count,record* = none.  
Default *first,count,record* = 1,1,1

## Important Points

- The RMEM command automatically shuts-off reading memory (MEM OFF). This means all previously stored readings remain intact and new readings are not stored.
- The HP 3457 assigns a number to each reading in reading memory. The most recent reading is assigned the lowest number (1) and the oldest reading has the highest number. Numbers are always assigned in this manner regardless of whether you're using the FIFO or LIFO mode. Records are also numbered in this manner—the most recent record is record number 1.

## RMEM (cont)

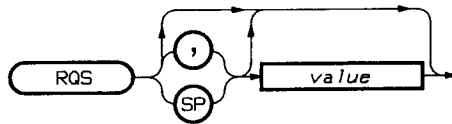
- When you execute the RMEM command from the front panel, readings are copied, one at a time, to the display. After viewing the first reading, you can view any others by using the up or down arrow key. When you execute the RMEM command from the controller, the reading(s) are copied to the output buffer. Individual readings are separated by commas, the final reading is followed by carriage return, line feed.
- In addition to the RMEM command, you can also recall readings using “implied read.” Refer to “Reading Memory” in Chapter 2 for a procedure on how to use “implied read.”

### Example

```
10 OUTPUT 722;"TARM HOLD"      ! SUSPENDS TRIGGERING
20 OUTPUT 722;"DCV"           ! SELECTS DC VOLTAGE MEASUREMENTS
30 OUTPUT 722;"TRIG AUTO"     ! SELECTS AUTOMATIC TRIGGERING
40 OUTPUT 722;"NRDGS 3,AUTO"  ! SELECTS 3 READINGS PER SAMPLE EVENT (AUTO)
50 OUTPUT 722;"MEM FIFO"      ! ENABLES READING MEMORY, FIFO MODE
60 OUTPUT 722;"TARM SGL,10"   ! CAUSES HP 3457 TO MAKE 10 GROUPS OF READINGS
70 OUTPUT 722;"RMEM 1,3,6"    ! RECALLS 1ST, 2ND, & 3RD READINGS FROM 6TH GROUP
80 ENTER 722;A,B,C           ! ENTERS READINGS INTO COMPUTER'S A, B, & C
                               VARIABLES
90 DISP A,B,C                ! DISPLAYS READINGS
100 END
```

The RQS (request service) command designates which status register conditions will set the SRQ line on the HP-IB bus.

**Syntax** RQS *value*



## Parameters

***value*** You enable a condition by specifying its decimal weight as the *value* parameter. For more than one condition, specify the sum of the weights. The conditions and their weights are:

Decimal Weight	Bit Number	Enables Condition
1	0	Program Memory Execution Completed
2	1	Hi or Lo Limit Exceeded
4	2	Front Panel SRQ
8	3	Power-On SRQ
16	4	Ready
32	5	Error (Consult Error Register)
64	6	Service Requested (you cannot disable this bit)
128	7	Not Used

### NOTE

*You can control the errors that will affect bit 5 using the EMASK command.*

**Power-on *value*:** If the Power-On SRQ was enabled when power was removed, *value* = 8. Otherwise, *value* = 0.

Default *value* = 0 (no conditions enabled).

## Important Points

- The power-on SRQ bit is stored in non-volatile memory. All other bits are cleared at power-on.

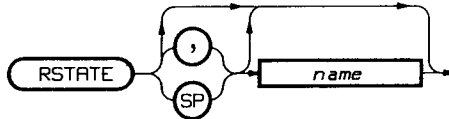
## RQS (cont)

<b>Examples</b>	OUTPUT 722;"RQS 4"	! ENABLES THE FRONT PANEL SRQ CONDITION
	OUTPUT 722;"RQS 40"	! ENABLES POWER-ON SRQ (8) & ERROR (32) CONDITIONS
	OUTPUT 722;"RQS 255"	! ENABLES ALL CONDITIONS
	OUTPUT 722;"RQS 0"	! DISABLES ALL CONDITIONS



The RSTATE (recall state) command recalls a stored state from memory and configures the HP 3457 to that state.

**Syntax** RSTATE *name*



## Parameters

***name*** The *name* parameter is a decimal number that designates the memory location. The parameter choices are:

<i>name</i> parameter	Description
0	Present state is stored here whenever power is removed
1 - 10	Non-volatile memory (stored state is not lost when power is removed)
11 - 30	Volatile memory (stored state is lost when power is removed)

Power-on *name* = none.

Default *name* = 0.

## RSTATE (cont)

### Important Points

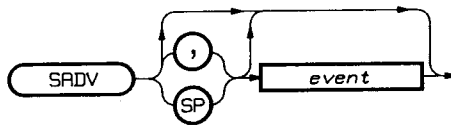
- You store states using the SSTATE command.
- Whenever the HP 3457's power is removed, the present state is stored in non-volatile memory location 0. After a power failure, the HP 3457 can be easily reconfigured by executing RSTATE 0.
- Stored states in memory locations 11 through 30 are destroyed whenever the HP 3457's power is removed.
- If you attempt to recall an empty memory location, you'll get a PARARANGE error (error 6).
- If a scan list was stored in a state, an advance is made to the first channel in the list when you recall the state.
- If the NULL math operation was enabled in a stored state, after recalling the state, the first reading is placed in the OFFSET register (refer to "NULL" in Chapter 3 for more information).

### Examples

OUTPUT 722;"RSTATE 2" ! RECALLS STORED STATE FROM LOCATION #2

The SADV (scan advance) command designates the event that causes an advance to the next channel in a plug-in card's scan list.

**Syntax** SADV *event*



## Parameters

*event* The *event* parameter choices are:

<i>event</i> Parameter	Decimal Equiv.	Description
HOLD	0	No advance occurs (use this to stop SADV AUTO)
SGL	1	Advances once and stays at that channel
AUTO	2	Advances after each measurement

Power-on *event* = HOLD.

Default *event* = SGL.

## Important Points

- You use the SADV command along with the SLIST command. The SLIST command designates the channel numbers in a scan list.
- Many of the “Important Points” under the SLIST command, also pertain to the SADV command.
- If you execute the SADV command without a plug-in card in the HP 3457's rear slot, you'll get the BAD HEADER error.

## SADV (cont)

<b>Example</b>	10 OUTPUT 722;"PRESET"	! PRESETS THE HP 3457
	20 OUTPUT 722;"TERM REAR"	! SELECTS INPUT SOURCE
	30 OUTPUT 722;"SADV AUTO"	! SETS SCAN ADVANCE TO AUTO
	40 OUTPUT 722;"SLIST 2,1,5,7,4"	! SETS-UP SCAN LIST, ADVANCES TO 1ST CHANNEL
	50 FOR I = 1 TO 5	! SETS-UP FOR/NEXT LOOP
	60 ENTER 722;A	! ENTERS EACH READING INTO A VARIABLE
	70 DISP A	! DISPLAYS A
	80 NEXT I	! RETURNS TO LINE 50
	90 END	

In the above program, the PRESET command (line 10) configures the HP 3457 to automatically make DC voltage measurements and selects the synchronous trigger mode. When the HP 3457 executes the SLIST command (line 40), it automatically advances to the first channel in the list (channel 2). After that, a scan advance occurs after each measurement causing an advance to the next channel beginning with 1, advancing to 5, 8, and 4. Since the trigger mode is synchronous, each measurement is initiated when the computer requests data (line 60). This program makes one measurement on each channel.

- Front Panel
- Remote

# SCRATCH

---

The SCRATCH command clears all subprograms from subprogram memory.

**Syntax** SCRATCH



**Important Points**

- SCRATCH clears every subprogram from memory. There is no way to selectively clear any one subprogram.

**Example**

OUTPUT 722;"SCRATCH"

! CLEARS SUBPROGRAM MEMORY

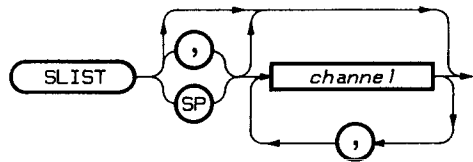
# SECURE

- Front Panel
  - Remote
- 
- 

This is a service related command. Refer to the HP 3457 service manual for details.

The SLIST (scan list) command designates a series of plug-in card channels to scan and advances to the first channel in the list.

**Syntax** SLIST *channel 1,channel 2, . . . channel n*



## Parameters

***channel*** You specify each *channel* parameter as the channel number you want to scan. The HP 3457 scans the channels in the order in which you specify them. The channel numbers are; 0 through 13 for the HP 44491, and 0 through 9 for the HP 44492. For channel 8 or 9 on the HP 44491, a special numbering scheme allows you to select a current input channel or to open or close an actuator:

Channel Number In Scan List	Effect on Channel 8 or 9
8	Channel 8 is a current input
9	Channel 9 is a current input
14	Opens the channel 8 actuator with delay
15	Opens the channel 9 actuator with delay
16	Closes the channel 8 actuator
17	Closes the channel 9 actuator
18	Opens the channel 8 actuator without delay
19	Opens the channel 9 actuator without delay

Power-on *channel* = none (empty list).

The default *channel* re-uses the previous list and selects the first channel in that list.

## SLIST (cont)

### Important Points

- You use the SLIST command along with the SADV command. The SADV command designates the event that causes an advance to the next channel in the list.
- To make a measurement on a scan list channel, you must specify the plug-in card as the input source using the TERM command. However, the plug-in card does not have to be specified as the input source to open or close an actuator channel.
- Advancing beyond the last channel in the scan list causes a wrap-around to the first channel in the list.
- From the controller, you can specify up to 20 channels in a scan list. From the HP 3457's front panel, however, the keyboard buffer limits the length to less than 20 channels.
- If you execute the SLIST command without a plug-in card in the HP 3457's rear slot, you'll get the BAD HEADER error.
- Refer to the SLIST command listed under your particular plug-in card in Chapter 5 for additional "Important Points."

### Example

```
10 OUTPUT 722;"PRESET"           ! RESETS THE HP 3457
20 OUTPUT 722;"TERM SCANNER"     ! SELECTS INPUT SOURCE
30 OUTPUT 722;"SADV AUTO"        ! SETS SADV TO AUTO
40 OUTPUT 722;"SLIST 3,5,16,6,14" ! SETS-UP SCAN LIST, STEPS TO 1ST CHANNEL
50 FOR I = 1 TO 5                 ! SETS-UP FOR/NEXT LOOP
60 ENTER 722;A                   ! ENTERS EACH READING INTO A VARIABLE
70 DISP A                        ! DISPLAYS EACH READING
80 NEXT I                         ! RETURNS TO LINE 50
90 END
```

In the above program, when the HP 3457 executes the SLIST command (line 40), it automatically advances to the first channel in the list (channel 3). After that, a scan advance occurs after each measurement causing an advance to the next channel beginning with 5, advancing to 16, 6, 14, and back to 3.

Notice that actuator designators 16 and 14 are included in the scan list. When advancing to 16, the channel 8 actuator closes. The previous input channel (channel 5) remains closed and measurements are made on it. When advancing to 6, the channel 8 actuator remains closed and the DC voltage measurement is made on channel 6. When advancing to 14, the channel 8 actuator opens. Again, the DC voltage measurement is made on the previously selected input channel (channel 6).



The SLIST? (scan list?) command returns the total number of channels in a scan list when executed from remote or the actual channels in the list when executed from the HP 3457's keyboard.

## Syntax SLIST?

SLIST? →

## Important Points

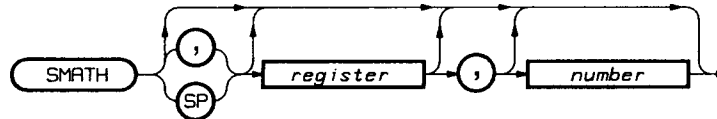
- From the HP 3457's front panel, you execute the SLIST? command by accessing the SLIST command from the alphabetic command directory and appending a question mark.
- When you execute the SLIST? command from the HP 3457's front panel, the response goes to the display. When executed from the controller, the response goes to the HP 3457's output buffer in ASCII format. After executing the SLIST? command, the output format returns to the previously specified type (SINT, DINT, SREAL, or ASCII).
- When executed from the front panel, the SLIST? command returns "EMPTY" if there is no scan list. When executed from remote, the SLIST? command returns 0 (zero) if there is no scan list.
- The display's buffer holds only 24 characters. It is possible to have more channels in the scan list than can be displayed.

## Example

```
10 OUTPUT 722;"SLIST?"      ! RETURNS THE NUMBER OF CHANNELS RESPONSE
20 ENTER 722;A              ! ENTERS RESPONSE INTO VARIABLE A
30 DISP A                   ! DISPLAYS RESPONSE
40 END
```

The SMATH (store math) command places a number in a math register.

**Syntax** SMATH *register,number*



## Parameters

***register*** The *register* parameter choices are:

<i>register</i> Parameter	Decimal Equiv.	Register Contents	Power-on Value
DEGREE	1	Determines step response for FILTER operation	20
LOWER	2	Smallest reading in STATS	0
MAX	3	Upper limit for PFAIL operation	0
MEAN	4	Average of readings in STATS	0
MIN	5	Lower limit for PFAIL	0
NSAMP	6	Number of samples in STATS	0
OFFSET	7	Subtrahend in NULL and SCALE operations	0
PERC	8	% value for PERC operation	1
REF	9	Reference value for DB operation	1
RES	10	Reference impedance for DBM operation	50
SCALE	11	Divisor in the SCALE operation	1
SDEV	12	Standard deviation in STATS	0
UPPER	13	Largest reading in STATS	0
HIRES	14	Extra digit for 10 or 100 plc measurements	0

Default *register* = DEGREE.

Power-on *register* = see above listing.

***number*** You specify the *number* parameter as the value you want to place in the register.

Default *number* = last reading.

Power-on *number* = see above listing.

## SMATH (cont)

### Important Points

- You can use the SMATH command to place a number into one of the registers that store readings (UPPER, SDEV, etc.), however that value will be replaced with a reading if the corresponding math function is enabled (e.g. STATS).
- The DB and DBM math operations check the value in the corresponding REF or RES register only once, after the first reading. For this reason, place a value in the REF or RES register before enabling the corresponding DB or DBM math operation.
- You cannot use -1 (minus 1) to default the *number* parameter. If you specify -1, you will actually write -1 to the register.

### Examples

```
OUTPUT 722;"SMATH 11,1E-3"           ! PLACES THE VALUE "1E-3" IN THE
                                       SCALE REGISTER

10 OUTPUT 722;"OHM"                   ! SELECTS 2-WIRE OHMS
20 OUTPUT 722;"TRIG SGL"               ! TRIGGERS ONCE
30 OUTPUT 722;"SMATH RES"              ! PLACES READING IN RES REGISTER
40 DISP "CONNECT VOLTAGE SOURCE; PRESS CONT" ! OPERATOR PROMPT
50 PAUSE                               ! SUSPENDS PROGRAM EXECUTION
60 OUTPUT 722;"ACV"                   ! SELECTS AC VOLTAGE
70 OUTPUT 722;"MATH DBM"               ! ENABLES DBM MATH OPERATION
80 OUTPUT 722;"TRIG AUTO"              ! TRIGGERS AUTOMATICALLY
90 END
```

In the above program, lines 10 and 20 measure the value of a resistance connected to the HP 3457. Line 30 defaults the number parameter causing the reading to be stored in the RES register. Line 40 instructs the operator to connect the voltage source to the HP 3457. Line 70 enables the DBM math operation. This program displays the power delivered to the resistance in DB (result of the DBM math operation).

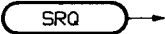
# SRQ

Front Panel  
 Remote

---

The SRQ (service request) command sets bit 6 in the HP 3457's status register and sets the HP-IB SRQ line.

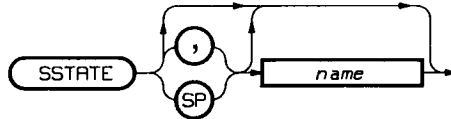
**Syntax** SRQ



**Example** OUTPUT 722;"SRQ" ! SETS BIT 6 AND THE SRQ LINE

The SSTATE (store state) command stores the HP 3457's present state into a numbered memory location.

**Syntax** SSTATE *name*



## Parameters

***name*** The *name* parameter is a decimal number that designates the memory location. The parameter choices are:

<i>name</i> parameter	Description
0	Present state is stored here whenever power is removed
1 - 10	Non-volatile memory (stored state is not lost when power is removed)
11 - 30	Volatile memory (stored state is lost when power is removed)

Power-on *name* = none.

Default *name* = 0.

## SSTATE (cont)

### Important Points

- The contents of the following math registers are stored when you store a state (all other registers are set to 0):

DEGREE	REF
LOWER	RES
OFFSET	SCALE
PERC	UPPER

- State memory is allocated in sequence. For example, if you allocate space for three states (in addition to state 0), you must use locations 1, 2, and 3 – you'll get the PARA RANGE error (bit 6) if you try to use another location.
- You need to allocate 69 bytes of state memory for each state you want to store. You allocate memory space using the MSIZE command. The default MSIZE value provides space for state locations 0 through 14. The HP 3457 always leaves space for memory location 0 regardless of the memory allocation.
- If you try to store more states than memory permits, you'll get a PARA RANGE error (bit 6).
- Whenever the HP 3457's power is removed, the present state is stored in non-volatile memory location 0. This happens regardless of whether or not you're using the SSTATE command. Any previously stored state in location 0 is replaced with the present state whenever power is removed.
- Stored states in memory locations 11 through 30 are destroyed whenever the HP 3457's power is removed.
- Stored states are recalled using the RSTATE command.

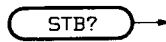
### Example

```
10 OUTPUT 722;"MSIZE 32,32"      ! SETS-UP 32 BYTES OF READING & PROGRAM MEMORY
20 OUTPUT 722;"SSTATE 2"        ! STORES PRESENT STATE IN LOCATION #2
30 END
```

By setting reading and program memory to their minimum sizes (32 bytes each), line 10 leaves 2144 bytes of memory for state storage (enough for 30 states).

The status register contains seven bits that monitor various HP 3457 conditions. When a condition occurs, the corresponding bit is set in the status register. The STB? (status byte?) command returns a number representing the set bits. The returned number is the weighted sum of all set bits.

## Syntax STB?



## Status Register Conditions

The status register conditions and their weights are:

Decimal Weight	Bit Number	Status Register Condition
1	0	Program Memory Execution Completed
2	1	Hi or Lo Limit Exceeded
4	2	Front Panel SRQ
8	3	Power On SRQ
16	4	Ready
32	5	Error (Consult Error Register)
64	6	Service Requested (you cannot disable this bit)
128	7	Not Used

## Important Points

- When you execute the STB? command, the ready bit (bit 4) is always clear (not ready) because the HP 3457 is processing the STB? command.
- When you execute the STB? command from the HP 3457's front panel, the weighted sum goes to the display. When executed from the controller, the weighted sum goes to the HP 3457's output buffer in ASCII format. After executing the STB? command, the output format returns to the previously specified type (SINT, DINT, SREAL, or ASCII).
- The STB? command returns a 0 if no error bits are set.
- The CSB command clears the status register. The RQS command designates which status register conditions will assert SRQ on the HP-IB bus.

## STB? (cont)

### Examples

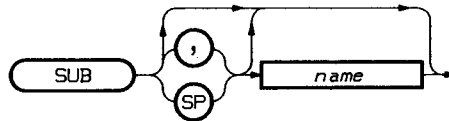
```
10 OUTPUT 722;"STB?" ! RETURNS THE WEIGHTED SUM OF ALL SET BITS
20 ENTER 722;A ! ENTERS RESPONSE INTO COMPUTER'S A VARIABLE
30 DISP A ! DISPLAYS RESPONSE
40 END
```

Assume the above program returns the weighted sum 24. This means the bits with weighted values 8 (power-on SRQ) and 16 (ready) are set.



The SUB (subprogram) command stores a subprogram into a numbered subprogram memory location.

**Syntax** SUB *name*



## Parameters

***name*** The *name* parameter is a decimal number from 0 to 19 that designates the subprogram memory location.

Power-on *name* = none.

Default *name* = 0.

## Important Points

- You indicate the end of a subprogram using the SUBEND command. You execute a subprogram using the CALL command. You can suspend subprogram execution, at some point, by including the PAUSE command in the subprogram.
- You can store up to 20 subprograms. The maximum subprogram size depends on the memory space allocated (MSIZE command). The default MSIZE value provides 100 bytes of space. If you don't allocate enough subprogram memory space, you'll get the SYNTAX ERROR when you attempt to store a subprogram. An example of how to determine the amount of memory space needed for a subprogram is under "Subprogram Storage" in Chapter 3.
- If you try to store a new subprogram using the name of an existing subprogram, the HP 3457 stores the new subprogram in another location in subprogram memory. Both subprograms still exist, but you cannot access the first. If there is not enough memory space for both subprograms, you'll get the SYNTAX ERROR.

## SUB (cont)

- If a syntax error, a CALL, SCRATCH, MSIZE, a second SUB, or the HP-IB Device Clear command occurs in a subprogram, the HP 3457 aborts subprogram storage. When aborted, none of the subprogram is stored, no memory is used, and any subsequent commands are executed – not stored.
- To save memory space, use the numeric equivalent of parameters or default them whenever possible.
- Subprograms are destroyed whenever the HP 3457's power is removed.

### Example

```
10 OUTPUT 722;"MSIZE 32,1000"    ! SETS-UP 32 BYTES OF READING & 1000 BYTES OF
                                ! SUBPROGRAM MEMORY
20 OUTPUT 722;"MEM FIFO"        ! ENABLES FIFO MODE OF READING MEMORY
30 OUTPUT 722;"SUB,2"           ! STORES LINES 30 TO 50 IN MEMORY LOCATION #2
40 OUTPUT 722;"DCI,1,.01"       ! SELECTS DC CURRENT MEASUREMENTS
50 OUTPUT 722;"NRDGS,5,AUTO"    ! SETS-UP 5 READINGS PER TRIGGER & AUTO EVENT
60 OUTPUT 722;"TRIG SGL"        ! SPECIFIES THE SINGLE TRIGGER MODE
70 OUTPUT 722;"SUBEND"          ! SIGNALS THE END OF SUBPROGRAM STORAGE
80 END
```

To execute the above subprogram, send:

```
OUTPUT 722;"CALL 2"
```

- Front Panel
- Remote

# SUBEND

---

The SUBEND (subprogram end) command signals the end of a subprogram.

## Syntax SUBEND



## Important Points

- When storing a subprogram, SUBEND signals the subprogram's end. When a subprogram has been executed, SUBEND sets bit 1 (if enabled) in the status register which signals the subprogram's completion.
- If you send SUBEND without first sending SUB, the HP 3457 sets the "Program Memory Execution Complete" bit (bit 1) in the status register.

## Example

```
10 OUTPUT 722;"MSIZE 32,100"      ! SETS-UP 32 BYTES READING, & 100 BYTES
                                ! SUBPROGRAM MEMORY
20 OUTPUT 722;"SUB,1"             ! STORES LINES 30 & 40 INTO LOCATION #1
30 OUTPUT 722;"DCI,1,.01"        ! SPECIFIES A DC CURRENT MEASUREMENT
40 OUTPUT 722;"TRIG,SGL"         ! SPECIFIES THE SINGLE TRIGGER MODE
50 OUTPUT 722;"SUBEND"           ! SIGNALS THE END OF SUBPROGRAM STORAGE
60 END
```

To execute the above subprogram, send:

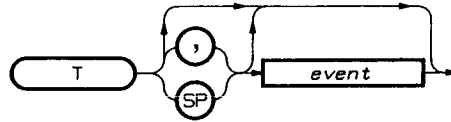
```
OUTPUT 722;"CALL 1"
```

# T

- Front Panel
- Remote

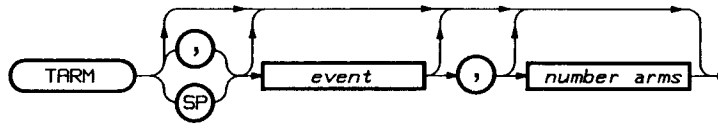
The T command is an abbreviation of the TRIG command. Except for the syntax, the T and TRIG commands are identical. Refer to the TRIG command for details.

## Syntax *T event*



The TARM (trigger arm) command defines the event that enables (arms) the specified trigger event. You can also use this command to perform multiple measurement cycles.

**Syntax** TARM *event,number arms*



## Parameters

***event*** The *event* parameter choices are:

<i>event</i> Parameter	Decimal Equiv.	Description
AUTO	1	Always armed
EXT	2	Armed on external input
SGL	3	Armed once (upon receipt of TARM SGL) then HOLD
HOLD	4	Trigger disabled
SYN	5	Armed when the HP 3457's output buffer is empty, reading memory is off or empty, and the controller requests data from the HP 3457.

Power-on *event* = AUTO.

Default *event* = AUTO.

***number arms*** You specify the *number arms* parameter as a number between 0 and 32767.

When you specify *number arms* as 0, the trigger is armed as shown in the above table.

When you specify a number from 1 to 32767 as the *number arms* parameter, you have selected "multiple arming." In multiple arming the HP 3457 generates enough single trigger arms to satisfy the *number arms* parameter. For example, if you specify 5 for *number arms*, the HP 3457 will arm the trigger 5 times. Refer to "multiple arming" in the Important Points below, for more information.

Power-on *number arms* = 0.

Default *number arms* = 0.

## TARM (cont)

### Important Points

- The trigger arm event operates along with the trigger event (a TRIG parameter) and the sample event (a NRDGS parameter). To make a measurement, the trigger arm event must occur first, followed by the trigger event, and finally the sample event.
- The trigger arm event does not necessarily *initiate* a trigger. It merely *enables* a trigger, making it possible for a trigger to occur. Refer to “Triggering” in Chapter 3 for an in-depth discussion of the interaction of the various events.
- The SGL trigger arm event and the SGL trigger event do not work together. Do not specify TARM SGL and TRIG SGL in the same program.
- Multiple arming: When using multiple arming, the trigger arm event must be specified as SGL. When the HP 3457 executes a TARM command specifying multiple arming, it holds the HP-IB bus until all measurement cycles are complete. For example, if you specify number arms as 5, and 10 readings per cycle (NRDGS command) there is 5 measurement cycles of 10 readings each. Since it holds the bus, the TARM command must be the last line in the program and you cannot use the synchronous trigger event or sample event. When the TARM command specifying multiple arming is encountered in a subprogram, subprogram execution is suspended until the measurement cycles are complete.

## TARM (cont)

**Examples**    OUTPUT 722;"TARM AUTO,0"    ! ARMS TRIGGERING AUTOMATICALLY (ALWAYS ARMED)

```
10 OUTPUT 722;"TARM HOLD"    ! SUSPENDS MEASUREMENTS
20 OUTPUT 722;"OHM"    ! SELECTS 2-WIRE OHMS MEASUREMENTS)
30 OUTPUT 722;"MSIZE 200"    ! ALLOCATES 200 BYTES FOR READING STORAGE
40 OUTPUT 722;"MEM FIFO"    ! ENABLES READING MEMORY, FIFO MODE
50 OUTPUT 722;"NRDGS 5"    ! SELECTS 5 READINGS PER SAMPLE EVENT (AUTO)
60 OUTPUT 722;"TARM SGL"    ! ENABLES ONE SERIES OF MEASUREMENTS
70 END
```

```
10 OUTPUT 722;"DCV"    ! SELECTS DC VOLTAGE MEASUREMENTS
20 OUTPUT 722;"TARM HOLD"    ! SUSPENDS MEASUREMENTS
30 OUTPUT 722;"TRIG AUTO"    ! SELECTS AUTO AS THE TRIGGER EVENT
40 OUTPUT 722;"MSIZE 200"    ! ALLOCATES 200 BYTES FOR READING STORAGE
50 OUTPUT 722;"MEM FIFO"    ! ENABLES READING MEMORY, FIFO MODE
60 OUTPUT 722;"NRDGS 3,AUTO"    ! SELECTS 3 READINGS PER SAMPLE EVENT (AUTO)
70 OUTPUT 722;"TARM SGL,5"    ! SELECTS MULTIPLE ARMING FOR 5 CYCLES
80 END
```

In this program, line 70 arms the trigger once for each measurement cycle. This occurs five times. After the fifth cycle, trigger arming reverts to HOLD. This program places 15 readings (3 readings per trigger event, 5 times) into reading memory.

Unless the input buffer is enabled, line 70 causes the HP-IB bus to be held until all measurement cycles are complete. If you want to regain control of the bus immediately, suppress the <CR> <LF> by replacing line 70 with:

```
70 OUTPUT 722 USING "#,K";"TARM SGL,5;"
```

---

### NOTE

*In the above line, the # image specifier suppresses the <CR> <LF>. The K image specifier suppresses trailing or leading spaces and outputs the command in free-field format. Notice the semicolon following the TARM SGL,5. This indicates the end of the command to the HP 3457 and must be present when you suppress <CR> <LF>.*

---

# TARM?

■ Front Panel

■ Remote

---

The TARM? (trigger arm?) command returns a number representing the trigger arm event. The events and their numbers are:

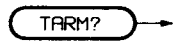
AUTO = 1

EXT = 2

HOLD = 4

SYN = 5

## Syntax TARM?



## Important Points

- After executing a SGL (3) trigger arm, the trigger arm event reverts to HOLD (4). This means the TARM? command cannot return 3 (SGL).
- From the HP 3457's front panel, you execute the TARM? command by accessing the TARM command from the alphabetic command directory and appending a question mark.
- When you execute the TARM? command from the HP 3457's front panel, the response goes to the display. When executed from the controller, the response goes to the HP 3457's output buffer in ASCII format. After executing the TARM? command, the output format returns to the previously specified type (SINT, DINT, SREAL, or ASCII).

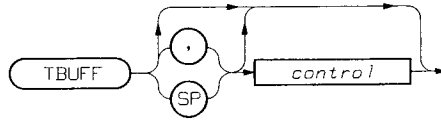
## Example

```
10 OUTPUT 722;"TARM?"           ! RETURNS THE TRIGGER ARM EVENT RESPONSE
20 ENTER 722;A                  ! ENTERS RESPONSE INTO VARIABLE A
30 DISP A                       ! DISPLAYS RESPONSE
40 END
```



The TBUFF (trigger buffer) command disables the TRIGGER TOO FAST error and stores the first external trigger that occurs during a measurement.

## Syntax *TBUFF control*



## Parameters

*control* The *control* parameter choices are:

<i>control</i> Parameter	Decimal Equiv.	Description
OFF	0	Disables trigger buffering and enables the TRIGGER TOO FAST error
ON	1	Enables trigger buffering and disables the TRIGGER TOO FAST error

Power-on *control* = OFF.

Default *control* = OFF.

## Important Points

- Executing the PRESET or RESET command sets TBUFF to OFF. Recalling a state does not affect the present TBUFF setting.
- If the HP 3457 is continuously triggered with the TBUFF command ON, it may ignore commands sent over the bus.

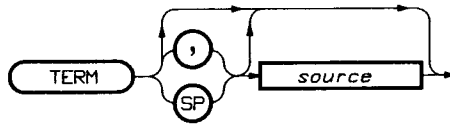
## Examples

OUTPUT 722;"TBUFF ON" ! DISABLES TRIGGER TOO FAST ERROR

This Page Intentionally Left Blank

The TERM (terminal) command selects the HP 3457's input source for making measurements.

**Syntax** TERM *source*



## Parameters

*source* The *source* parameter choices are:

<i>source</i> Parameter	Decimal Equiv.	Description
OPEN	0	Disconnects all input sources
FRONT	1	Selects front terminals
REAR	2	Selects rear terminals or plug-in card
SCANNER	2	Selects rear terminals or plug-in card

Power-on *source* = FRONT.

Default *source* = FRONT.

## Important Points

- Both the REAR and SCANNER *source* parameters select whatever device is installed in the rear of the HP 3457. This can be either the rear terminal block or a plug-in card.

**Example** OUTPUT 722;"TERM SCANNER" ! SELECTS DEVICE IN REAR SLOT AS INPUT SOURCE

# TERM?

■ Front Panel

■ Remote

---

The TERM? (terminal?) command returns a number representing the presently selected input terminals. The possible numbers are:

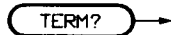
0 = all input terminals disconnected

1 = front terminals

2 = rear terminals or plug-in card

## Syntax

TERM?



## Important Points

- From the HP 3457's front panel, you execute the TERM? command by accessing the TERM command from the alphabetic command directory and appending a question mark.
- When you execute the TERM? command from the HP 3457's front panel, the response goes to the display. When executed from the controller, the response goes to the HP 3457's output buffer in ASCII format. After executing the TERM? command, the output format returns to the previously specified type (SINT, DINT, SREAL, or ASCII).

## Example

```
10 OUTPUT 722;"TERM?"           ! RETURNS TERMINAL RESPONSE
20 ENTER 722;A                   ! ENTERS RESPONSE INTO VARIABLE A
30 DISP A                         ! DISPLAYS RESPONSE
40 END
```

The TEST command causes the HP 3457 to perform a series of internal self-tests.

## Syntax TEST



## Important Points

- Always disconnect any input signals before you run self-test. If you leave an input signal connected to the HP 3457, it may cause a self-test failure.
- Self-test failures can set bit 9 or 10 in the error register, and any of the hardware error bits in the auxiliary error register. If a hardware error occurs, the HP 3457 sets bit 0 in the error register and a more descriptive bit in the auxiliary error register. The display's ERR annunciator flashes whenever an error is in the error register. You access the error registers with the ERR? and AUXERR? commands.
- The HP 3457's self-tests are very extensive. If no failures occur, you have a very high confidence level that the HP 3457 is working and that measurements will be accurate.
- A self-test failure indicates that the HP 3457 is out of calibration or malfunctioning. If bit 10 is set in the error register (ACAL REQUIRED) perform autocalibration and repeat the self-test. If self-test fails again, refer to the HP 3457 Service Manual for further information.
- You read the error register using the ERR? command. You read the auxiliary error register using the AUXERR? command.

## TEST (cont)

**Examples**    OUTPUT 722;"TEST"            ! RUNS SELF-TEST

The above example sends <CR> <LF> following the command which causes the HP-IB bus to be held (unless the input buffer is enabled) until the self-test is complete. If you want to run self-test and regain control of the bus immediately, suppress the <CR> <LF> by sending:

OUTPUT 722 USING "#,K";"TEST;"

---

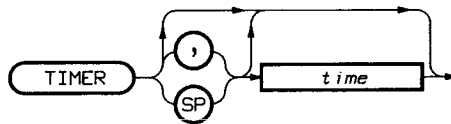
### NOTE

*In the above line, the # image specifier suppresses the <CR> <LF>. The K image specifier suppresses trailing or leading spaces and outputs the command in free-field format. Notice the semicolon following the TEST. This indicates the end of the command to the HP 3457 and must be present when you suppress <CR> <LF>.*

---

The TIMER command defines the time interval for the TIMER sample event in the NRDGS command. When using the TIMER event, the time interval is inserted between readings.

**Syntax** `TIMER time`



## Parameters

***time*** You specify the *time* parameter as a number between 600E-6 (600  $\mu$ second) and 2100 (seconds) in 1  $\mu$ second increments.

Power-on *time* = 1 (second).

Default *time* = 1 (second).

## Important Points

- The *time* is most accurate for DC voltage measurements (DCV command) with .1 or less power line cycles of integration time (NPLC command), and autozero is disabled (AZERO command). The *time* is less accurate for other measurement functions, different integration times, and when autozero is enabled. The *time* is very inaccurate when the HP 3457 is in the overload condition.
- When using the TIMER event, the first reading occurs without the time interval. However, you can insert a time interval before the first measurement using the DELAY command.
- When using the TIMER event, autoranging is suspended. Autoranging resumes when you specify a different sample event.
- The specified time equals the time from the beginning of one reading to the beginning of the next reading.

## TIMER (cont)

**Examples**

```
OUTPUT 722;"TIMER 3"           ! SELECTS 3 SECOND INTERVAL BETWEEN READINGS

10 OUTPUT 722;"TRIG HOLD"      ! SUSPENDS MEASUREMENTS
20 OUTPUT 722;"INBUF ON"      ! ENABLES THE INPUT BUFFER
30 OUTPUT 722;"DCV"           ! SELECTS DC VOLTAGE MEASUREMENTS
40 OUTPUT 722;"NPLC .1"       ! SELECTS .1 PLC OF INTEGRATION TIME
50 OUTPUT 722;"AZERO OFF"     ! DISABLES AUTOZERO
60 OUTPUT 722;"MSIZE 200"     ! ALLOCATES 200 BYTES OF READING MEMORY
70 OUTPUT 722;"MEM FIFO"      ! ENABLES READING MEMORY (FIFO MODE)
80 OUTPUT 722;"TIMER 2"       ! SELECTS 2 SECOND INTERVAL
90 OUTPUT 722;"NRDGS 10,TIMER" ! SELECTS 10 READINGS PER SAMPLE EVENT (TIMER)
100 OUTPUT 722;"TRIG SGL"     ! TRIGGERS ONCE
110 END
```



The `TIMER?` command returns the present time interval, in seconds, for the NRDGS timer event.

## Syntax

`TIMER?`



## Important Points

- From the HP 3457's front panel, you execute the `TIMER?` command by accessing the `TIMER` command from the alphabetic command directory and appending a question mark.
- When you execute the `TIMER?` command from the HP 3457's front panel, the response goes to the display. When executed from the controller, the response goes to the HP 3457's output buffer in ASCII format. After executing the `TIMER?` command, the output format returns to the previously specified type (`SINT`, `DINT`, `SREAL`, or `ASCII`).

## Example

```
10 OUTPUT 722;"TIMER?"      ! RETURNS TIME INTERVAL RESPONSE
20 ENTER 722;A              ! ENTERS RESPONSE INTO VARIABLE A
30 DISP A                   ! DISPLAYS RESPONSE
40 END
```

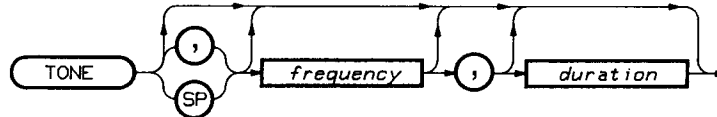
# TONE

■ Front Panel

■ Remote

The TONE command generates a tone from the HP 3457's beeper.

**Syntax** TONE *frequency,duration*



## Parameters

***frequency*** You specify the *frequency* parameter as a number between 0 and 3000 (Hz).

***duration*** You specify the *duration* parameter as a number between 0 and 32767 (milliseconds).

Power-on *frequency, duration* = none.

Default *frequency, duration* = 2048, 512.

## Important Points

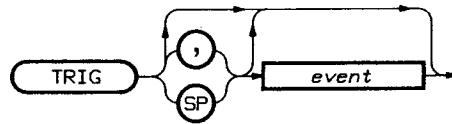
- The BEEP command has no affect on the tone command.

## Example

OUTPUT 722;"TONE 1500, 1200" ! GENERATES A 1500 HZ FOR 1200 mSECONDS

The TRIG (trigger) command allows you to specify the event that enables a measurement.

## Syntax `TRIG event`



## Parameters

*event* The *event* parameter choices are:

<i>event</i> Parameter	Decimal Equiv.	Description
AUTO	1	Triggers when not busy
EXT	2	Triggers on external input
SGL	3	Triggers once (upon receipt of TRIG SGL) then HOLDS
HOLD	4	Stops Triggering
SYN	5	Triggers when the HP 3457's output buffer is empty, reading memory is off or empty, and the controller requests data from the HP 3457.

Power-on *event* = AUTO.

Default *event* = SGL.

## TRIG (cont)

### Important Points

- The trigger event operates along with the trigger arm event (a TARM parameter) and the sample event (a NRDGS parameter). To make a measurement, the trigger arm event must occur first, followed by the trigger event, and finally the sample event.

The trigger event does not necessarily *initiate* a measurement. It merely *enables* a measurement, making it possible for a measurement to take place. The measurement is initiated when the sample event (NRDGS command) occurs. Refer to “Triggering Measurements” in Chapter 3 for an in-depth discussion of the interaction of the various events.

- The SGL trigger arm and the SGL trigger events do not work together. Do not specify TARM SGL and TRIG SGL in the same program.
- The number of measurements made per trigger and the event that initiates each measurement (sample event) is determined by the NRDGS command. When the NRDGS command specifies 1 reading and the AUTO sample event, the trigger event initiates the measurement.
- The trigger function must be armed (see the TARM command) before the TRIG command can enable a measurement.

### Examples

```
OUTPUT 722;"TRIG AUTO"      ! SELECTS AUTO TRIGGER

10 OUTPUT 722;"DCV 3,.1"    ! SELECTS A DC VOLTAGE MEASUREMENT
20 OUTPUT 722;"NRDGS 1,SYN" ! SELECTS 1 READING/TRIGGER & SYN
30 OUTPUT 722;"MEM OFF"    ! SHUTS READING MEMORY OFF
40 OUTPUT 722;"TRIG EXT"   ! SELECTS EXTERNAL TRIGGER MODE
50 ENTER 722;A             ! READS THE HP 3457's OUTPUT BUFFER
60 DISP A                  ! DISPLAYS READINGS
70 END
```

The above program shows the interaction of the TRIG and NRDGS commands. Notice that the trigger and sample events must occur in the proper sequence before the measurement takes place. First, a transition must occur on the HP 3457's external trigger input to meet the trigger requirement (line 40). Next, the synchronous event (controller requesting data with output buffer empty) must occur to satisfy the sample event and initiate the measurement.

## TRIG (cont)

```
10 OUTPUT 722;"DCV"           ! SELECTS DC VOLTAGE MEASUREMENTS
20 OUTPUT 722;"TRIG HOLD"     ! SUSPENDS MEASUREMENTS
30 OUTPUT 722;"NRDGS 30,AUTO" ! SELECTS 3 READINGS PER SAMPLE EVENT (AUTO)
40 OUTPUT 722;"TRIG SGL"     ! GENERATES A SINGLE TRIGGER
50 END
```

The above program shows a method to suspend measurements until the HP 3457 is properly configured. Line 20 suspends measurements by setting the trigger event to HOLD. Line 30 specifies 3 readings per trigger event. Line 40 generates a single trigger causing the HP 3457 to make three readings. After the three readings are complete, the trigger event reverts to HOLD.

Unless the input buffer is enabled, line 40 causes the HP-IB bus to be held until the measurement sequence is complete. If you want to regain control of the bus immediately, suppress the <CR> <LF> by replacing line 40 with:

```
40 OUTPUT 722 USING "#,K";"TRIG SGL;"
```

---

### NOTE

*In the above line, the # image specifier suppresses the <CR> <LF>. The K image specifier suppresses trailing or leading spaces and outputs the command in free-field format. Notice the semicolon following the TRIG SGL. This indicates the end of the command to the HP 3457 and must be present when you suppress <CR> <LF>.*

---

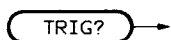
# TRIG?

- Front Panel
- Remote

The TRIG? (trigger?) command returns a number representing the trigger event. The events and their numbers are:

AUTO = 1  
EXT = 2  
HOLD = 4  
SYN = 5

## Syntax TRIG?



## Important Points

- After executing a single trigger (TRIG SGL), the trigger event reverts to HOLD (4). For this reason, the TRIG? command will never return 3 (TRIG SGL).
- From the HP 3457's front panel, you execute the TRIG? command by accessing the TRIG command from the alphabetic command directory and appending a question mark.
- When you execute the TRIG? command from the HP 3457's front panel, the response goes to the display. When executed from the controller, the response goes to the HP 3457's output buffer in ASCII format. After executing the TRIG? command, the output format returns to the previously specified type (SINT, DINT, SREAL, or ASCII).

## Example

```
10 OUTPUT 722;"TRIG?"           ! RETURNS THE TRIGGER EVENT RESPONSE
20 ENTER 722;A                   ! ENTERS RESPONSE INTO VARIABLE A
30 DISP A                         ! DISPLAYS RESPONSE
40 END
```

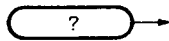
- Front Panel
- Remote

?

---

When the HP 3457 is properly configured (see “Prerequisites” below), the ? command generates a single trigger.

## Syntax ?



**Prerequisites** The HP 3457 must be configured to accept the ? command before you send the ? command. Configure the HP 3457 by sending the following commands:

```
TARM AUTO
NRDGS 1,AUTO
TRIG HOLD or SGL
```

If the HP 3457 has not been configured as shown above, no single trigger will be generated and you'll get the BAD HEADER error (bit 4) when you send the ? command.

## Important Points

- You can append an HP 3457 command to a ? command without the need for a delimiter. This is shown in the second example below.
- You can send a series of ? commands without the need for delimiters. If the input buffer is enabled, however, a series of ? commands will flag the TRIGGER TOO FAST error (bit 2). Always disable the input buffer (INBUF OFF) before sending a series of ? commands. This is shown in the third example below.
- You cannot store a ? command as part of a subprogram. If you attempt to store a ? command in a subprogram, the HP 3457 aborts subprogram storage and flags the SYNTAX ERROR (bit 3).
- Do not confuse the remote ? command with the shifted ? key on the HP 3457's front panel. The ? key is used for appending a question mark to a command to create a query command.

## ? (cont)

### Examples

```
10 OUTPUT 722;"TARM AUTO" ! SELECTS AUTO TRIGGER ARMING
20 OUTPUT 722;"NRDGS 1,AUTO" ! SELECTS 1 READING PER SAMPLE EVENT (AUTO)
30 OUTPUT 722;"TRIG HOLD" ! SETS TRIGGERING TO HOLD
40 OUTPUT 722;"DCV" ! SELECTS DC VOLTAGE
50 OUTPUT 722;"?" ! GENERATES SINGLE TRIGGER
60 END
```

```
OUTPUT 722;"?BEEP" ! GENERATES SINGLE TRIGGER AND BEEPS
```

```
10 OUTPUT 722;"INBUF OFF" ! DISABLES INPUT BUFFER
20 OUTPUT 722;"F13?????" ! SELECTS DC VOLTAGE, 3 V RANGE, GENERATES 5
SINGLE TRIGGERS
30 END
```





## CONTENTS

Introduction.....	4-167
ABORTIO 7 (IFC).....	4-168
CLEAR (DCL or SDC).....	4-169
LOCAL (GTL).....	4-170
LOCAL LOCKOUT (LLO).....	4-171
REMOTE.....	4-172
SPOLL (Serial Poll).....	4-173
TRIGGER (GET).....	4-174

# HP-IB Commands

---

## Introduction

The following BASIC language HP-IB commands are specifically for HP Series 80 and Series 200 computers. Any IEEE-488 controller can send these messages, however, the syntax may be different from that shown here. The IEEE-488 terminology is shown in parentheses following each command title. All syntax statements and examples assume an interface select code of 7 and the device address of 22.

The HP 3457 recognizes only the HP-IB commands referenced in this section. All other HP-IB commands are ignored by the HP 3457.

# ABORTIO 7 (IFC)

---

The ABORTIO command clears the HP 3457's interface circuitry.

**Syntax** ABORTIO 7

**Example** ABORTIO 7 ! CLEARS THE HP 3457'S INTERFACE CIRCUITRY

# CLEAR (DCL or SDC)

---

The CLEAR command clears the HP 3457 preparing it to receive a command. The CLEAR command does the following:

- Disables external trigger.
- Clears the output buffer.
- Clears the input buffer.
- Suspends subprogram execution.
- Performs the power-on self-test.
- Clears the status register (except power-on bit).
- Clears the display.
- Disables triggering (triggering can be enabled by sending any of the following commands:

- TRIG
- TARM
- NRDGS
- PRESET
- RSTATE
- RESET
- TIMER
- CAL
- ACAL
- TRIGGER (Group Execute Trigger)

**Syntax** CLEAR 7  
CLEAR 722

**Examples** CLEAR 7                   ! CLEARS ALL DEVICES (DCL) ON THE BUS (SELECT CODE 7)  
CLEAR 722                   ! CLEARS THE DEVICE (SDC) AT ADDRESS 22 (SELECT CODE 7)

# LOCAL (GTL)

---

The LOCAL command removes the HP 3457 from the remote state and enables its keyboard (provided the keyboard has not been disabled with the LOCK command from the HP 3457 command set).

**Syntax** LOCAL 7  
LOCAL 722

**Important Points**

- If the HP 3457's LOCAL key is disabled by LOCAL LOCKOUT, the LOCAL 722 command enables the keyboard but a subsequent remote command disables the keyboard. Sending the LOCAL 7 command, however, returns front panel control even after a subsequent remote message.

**Examples**

LOCAL 7	! SETS HP-IB REN LINE FALSE (ALL DEVICES GO TO LOCAL)
LOCAL 722	! ISSUES HP-IB GTL TO DEVICE AT ADDRESS 22

# LOCAL LOCKOUT (LLO)

---

The LOCAL LOCKOUT command disables the HP 3457's LOCAL key.

**Syntax** LOCAL LOCKOUT 7

## Important Points

- If the HP 3457 is in the local state when you send LOCAL LOCKOUT, it remains in local. If the HP 3457 is in the remote state when you send LOCAL LOCKOUT, its LOCAL key and keyboard are disabled immediately.
- After disabling the LOCAL key with LOCAL LOCKOUT, you can only enable it by sending the HP-IB LOCAL 7 command or by cycling power.
- If the HP 3457's LOCAL key is disabled by LOCAL LOCKOUT, the LOCAL 722 command enables the keyboard but a subsequent remote command disables it. Sending the LOCAL 7 command, however, enables the LOCAL key and keeps it enabled even after a subsequent remote message.
- If the HP 3457's keyboard is disabled by both LOCAL LOCKOUT and the LOCK command, you must clear both to regain control of the keyboard. LOCAL LOCKOUT is cleared with the LOCAL command. LOCK is cleared by setting LOCK to OFF.

## Examples

```
10 REMOTE 722      ! SETS DEVICE AT ADDRESS 22 TO REMOTE STATE
20 LOCAL LOCKOUT 7 ! SENDS LOCAL LOCKOUT (LLO) TO ALL DEVICES ON THE BUS
30 END
```

# REMOTE

---

The REMOTE command sets the HP-IB REN line true.

**Syntax** REMOTE 7  
REMOTE 722

- Important Points**
- The REMOTE 722 command places the HP 3457 in the remote state. The REMOTE 7 command, does not, in itself, place the HP 3457 in the remote state. After sending the REMOTE 7 command, the HP 3457 will only go into the remote state after it is addressed.
  - In most cases, you will only need the REMOTE command after using the LOCAL command. REMOTE is independent of any other HP-IB activity and is sent on a single bus line called REN. Most controllers set the REN line true when power is applied or when reset.

**Examples** REMOTE 7 ! SETS HP-IB REN LINE TRUE

The above line does not, in itself, place the HP 3457 in the remote state. The HP 3457 will only go into the remote state when it is addressed (e.g., sending OUTPUT 722;“BEEP”).

REMOTE 722 ! SETS REN LINE TRUE AND ADDRESSES DEVICE 22

The above line places the HP 3457 in the remote state.



# SPOLL (Serial Poll)

The SPOLL command, like the STB? command (HP 3457 command set), returns a number representing the set bits in the status register (status byte). The returned number is the weighted sum of all set bits.

**Syntax** P = SPOLL (722)

**Status Register Bits** The bits and their corresponding weights are:

Bit Number	Decimal Weight	Description
0	1	Program memory execution completed
1	2	Hi or lo limit exceeded
2	4	Front panel SRQ key pressed
3	8	Power-on SRQ occurred
4	16	Ready
5	32	Error (consult error register)
6	64	Service requested
7	128	Not used

## Important Points

- If the SRQ line is set true when you send SPOLL, all bits in the status register are cleared provided the condition that set the bit(s) is no longer present. If the SRQ line is false when you send SPOLL, the status register's contents are not changed.
- The SPOLL command differs from the STB? command in that STB? interrupts the HP 3457's microprocessor. Thus, with STB?, the HP 3457 always appears to be busy (bit four clear). SPOLL simply extracts the status byte without interrupting the microprocessor. Therefore, you can use SPOLL to monitor the readiness of the HP 3457 for further instructions.
- If data is in the output buffer when you send the SPOLL command, that data remains intact. If data is in the output buffer when you send the STB? command, however, the data is replaced by the status data.

## Examples

```
10 P = SPOLL (722)      ! SENDS SERIAL POLL, PLACES RESPONSE IN P VARIABLE
20 DISP P              ! DISPLAYS RESPONSE
30 END
```

# TRIGGER (GET)

---

If triggering is armed (see TARM command), the TRIGGER command (Group Execute Trigger) triggers the HP 3457 once, then holds triggering.

**Syntax** TRIGGER 7  
TRIGGER 722

- Important Points**
- The TRIGGER command generates a single trigger regardless of the present triggering configuration. It will not, however, trigger the HP 3457 if trigger arming is set to HOLD.
  - If subprogram memory execution is suspended by the PAUSE command (HP 3457 command set), the TRIGGER command resumes subprogram execution but does not generate a single trigger.

**Examples**

TRIGGER 7	! SENDS GROUP EXECUTE TRIGGER (GET)
TRIGGER 722	! SENDS GROUP EXECUTE TRIGGER (GET) TO THE DEVICE AT ADDRESS 22



## CONTENTS

	Page		Page
Introduction .....	5-1	Example Program .....	5-22
Installing a Plug-In Card .....	5-1	Program Description .....	5-22
Installation Procedure .....	5-2	Using the Actuators .....	5-23
Configuring the Wiring Block .....	5-4	Contact Protection .....	5-24
Strain Relief Housing .....	5-4	Designing RC Networks .....	5-24
Removing a Plug-In Card .....	5-6	Varistors .....	5-25
The HP 44491 Armature Relay Multiplexer Card .....	5-8	Replacing a Current Fuse .....	5-26
2-Wire Channels .....	5-8	Specifications .....	5-27
4-Wire Channels .....	5-8	Accessories .....	5-27
Current Input and Actuator Channels .....	5-10	The HP 44492 Reed Relay Multiplexer Card .....	5-28
⚠ Wiring Block .....	5-10	⚠ Channels .....	5-28
Command List .....	5-11	Command List .....	5-29
CRESET Command .....	5-11	CRESET Command .....	5-29
TERM Command .....	5-12	TERM Command .....	5-29
OPT? Command .....	5-12	OPT? Command .....	5-30
CHAN Command .....	5-13	CHAN Command .....	5-31
CHAN? Command .....	5-15	CHAN? Command .....	5-32
OPEN Command .....	5-15	SLIST Command .....	5-32
CLOSE Command .....	5-16	SLIST? Command .....	5-33
SLIST Command .....	5-17	SADV Command .....	5-34
SLIST? Command .....	5-19	Making 2-Wire Measurements .....	5-35
SADV Command .....	5-19	Example Program .....	5-35
2-Wire Measurements .....	5-20	Program Description .....	5-35
Example Program .....	5-20	Specifications .....	5-36
Program Description .....	5-21	Accessories .....	5-36
4-Wire Ohms Measurements .....	5-22		

## Chapter 5

# Plug-In Cards

---

## Introduction

This chapter contains installation and configuration procedures, commands, application examples, and specifications for the HP 3457's optional plug-in cards.

## Installing a Plug-In Card

The following installation procedure is written specifically for a service trained technician. It provides the information necessary to remove the HP 3457's rear terminal assembly and to install and configure an optional plug-in card. The installation procedure is identical for all plug-in cards. Read this section carefully, paying particular attention to the warnings and cautions.

---

### WARNING

*Only qualified service trained personnel should remove, install, or configure the HP 3457's rear terminal assembly or an optional plug-in card. Disconnect the HP 3457's power cord from the back of the instrument prior to removing or installing the rear terminal assembly or a plug-in card.*

*Remove all input lines from the HP 3457's front and rear input terminals before removing or installing the rear terminal assembly or a plug-in card.*

---

The HP 3457 was shipped from the factory with no plug-in cards installed. Instead, a rear terminal assembly was installed in the plug-in card slot. Consequently, the rear terminal assembly must be removed before a plug-in card can be installed.

The optional plug-in cards are packaged separately from the HP 3457. Each plug-in card contains a wiring block and a two-piece strain relief housing.

---

## CAUTION

*Use clean handling and anti-static procedures when removing, configuring, and installing a plug-in card. The plug-in cards as well as the HP 3457 mainframe contain components that are susceptible to damage from static electricity.*

---

## Installation Procedure

The following procedure describes how to install a plug-in card.

1. Remove the AC power cord from the HP 3457 before installing or removing a plug-in card or the rear terminal assembly. Also remove any input connections to the front or rear terminals.
2. Position the HP 3457 on a table top with its rear panel facing toward you.
3. Unscrew the two captive screws securing the rear terminal assembly. Pull the rear terminal assembly toward you until the wiring harness connector is exposed.
4. Depress the release levers on either side of the wiring harness connector (see Figure 5-1). Disconnect the connector from the rear terminal assembly by pulling the two apart.

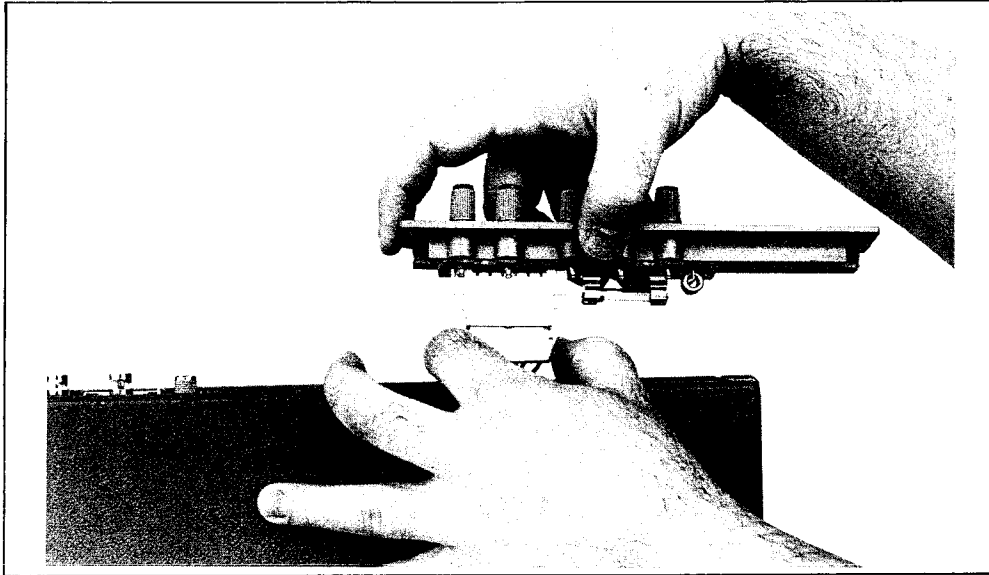
---

## NOTE

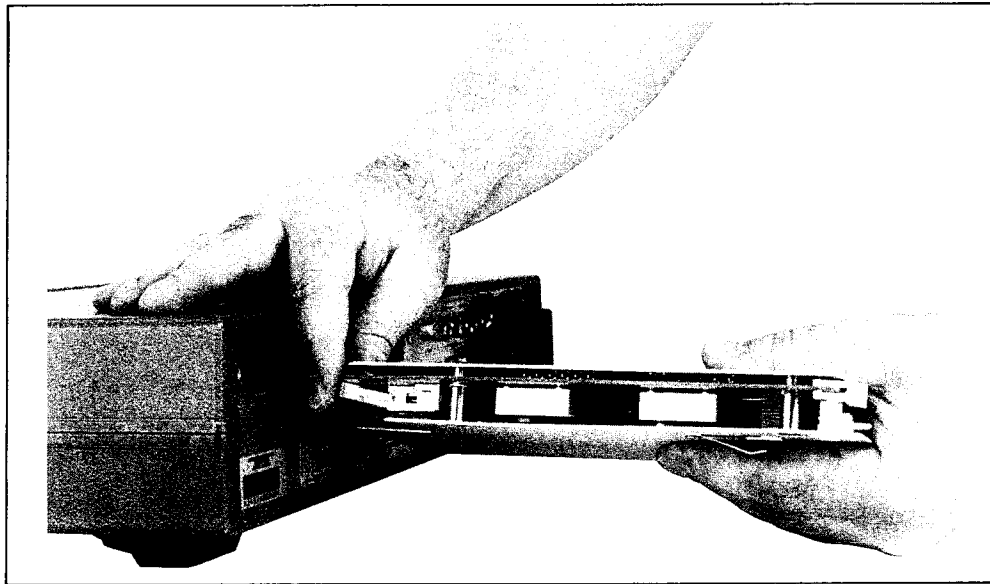
*Do not touch the exposed connector on the plug-in card. Fingerprints reduce the impedance in high humidity conditions.*

---

5. Unfold the plug-in card's two white plastic "ears" by pulling them away from the card. Notice that each ear has a detent that tends to hold it in the closed position.
6. Connect the wiring harness connector to the plug-in card connector as shown in Figure 5-2.

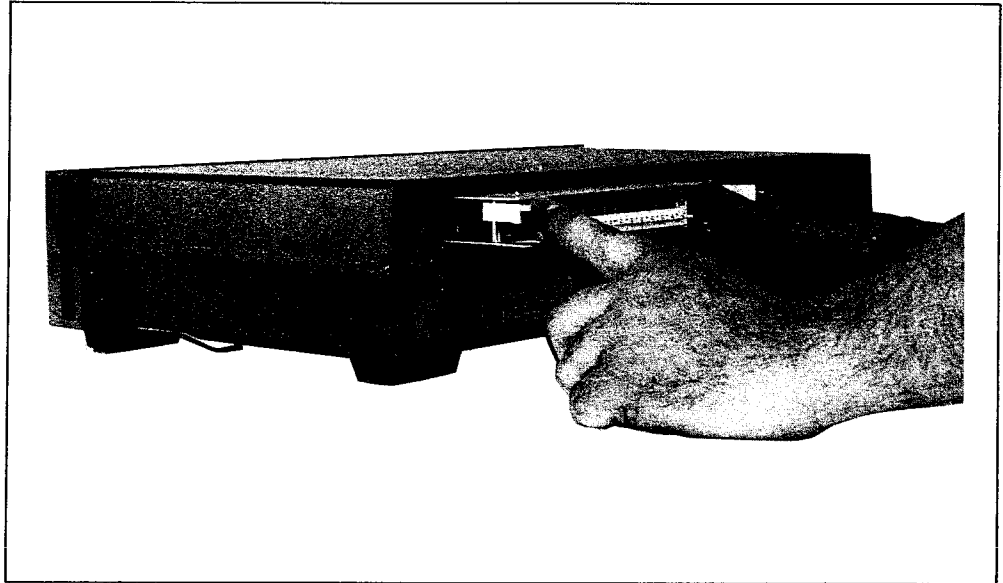


**Figure 5-1. Disconnecting the Wiring Harness**



**Figure 5-2. Connecting the Wiring Harness**

7. Position the plug-in card so the ears are pointing outward and the component side of the printed circuit board is facing downward. Gently slide the card into the guides in the rear of the HP 3457 (see Figure 5-3). Firmly push the card into the HP 3457 until it stops.



**Figure 5-3. Inserting a Plug-In Card**

8. Fold the plastic ears toward the card. As the ears are folded-in they push the card into the slot. This locks the card into place and engages the card's connector into the HP 3457's internal connector.

## **Configuring the Wiring Block**

As shown in Figure 5-4, each wire is connected to the wiring block by (1) loosening the appropriate screw, (2) inserting the wire (with the insulation stripped) into the appropriate slot, and (3) tightening the screw. Refer to the section of this chapter dealing with a specific plug-in card for details concerning the channel connections for your particular wiring block.

## **Strain Relief Housing**

1. Secure the wiring block to the strain relief housing using the wiring block's captive screws (see Figure 5-5). After tightening these screws, verify that the clamping screws are accessible through the holes in the top of the strain relief housing. If not, adjust the captive wiring block screws.

2. Strain relief considerations:

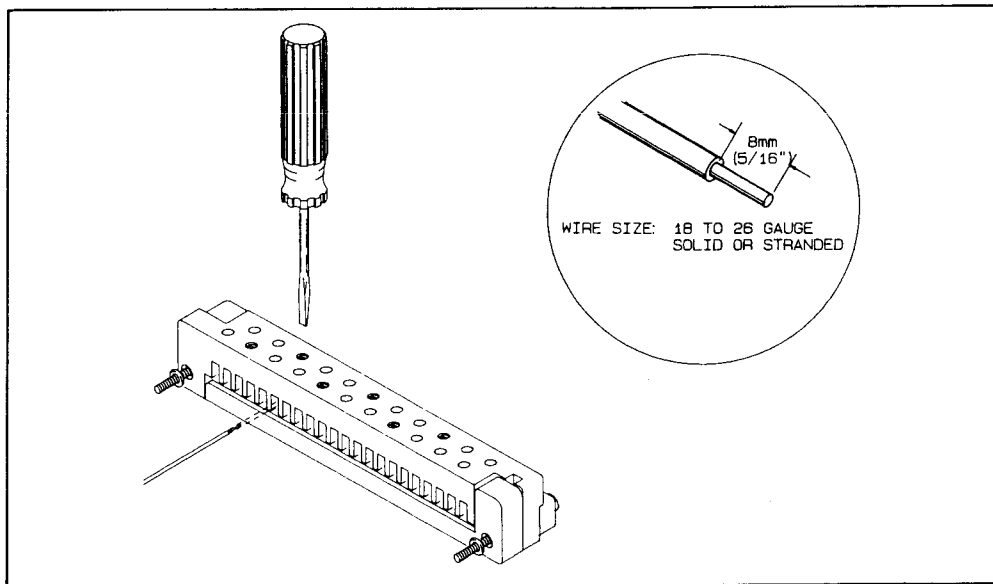
a. For wires larger than 22AWG, separate the wires into three evenly numbered bundles. Place one bundle into each of the three strain relief cutouts. This ensures uniform strain relief on all wires. If only a few wires are used, route them all through the middle cutout.



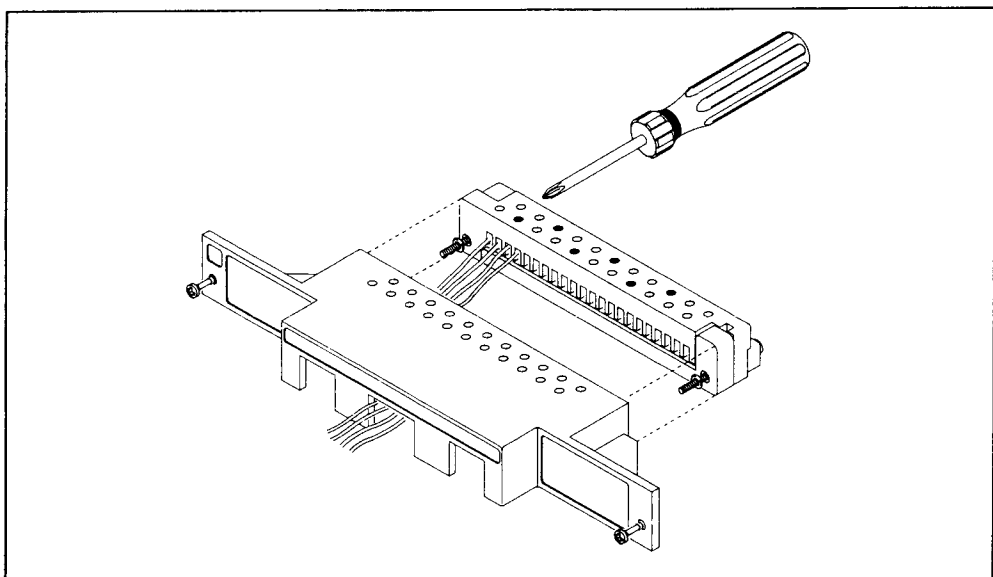
b. For wires smaller than 22AWG, bundle the wires together at a distance no more than 4 inches from the rear of the HP 3457. Failure to do this may cause the wires to break at the strain relief housing.

For example, a single 26AWG wire can survive about 7 to 8 pounds of tension before it breaks. A bundle of 10, however, can survive up to 70 pounds of tension.

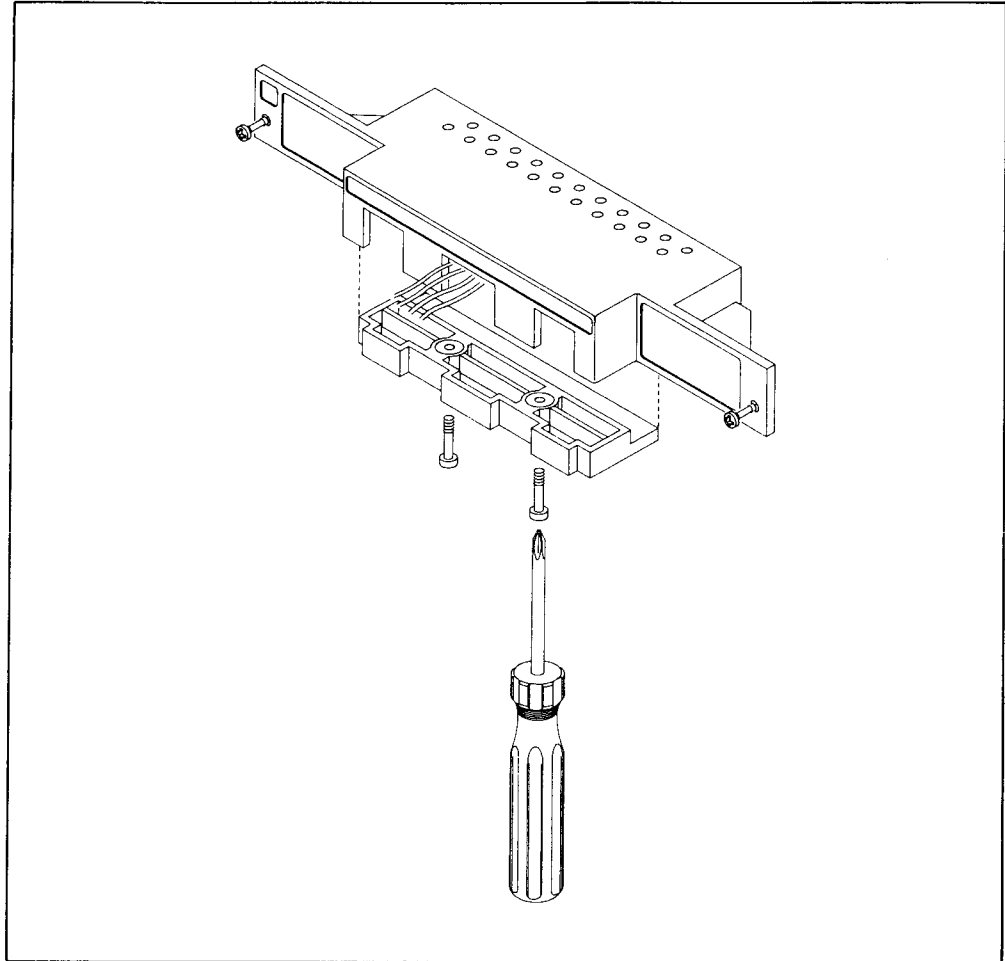
3. Secure the strain relief plate to the strain relief housing as shown in Figure 5-6. Tighten the screws until the plate is snug against the wires. Do not over-tighten the screws.



**Figure 5-4. Connecting a Wire to the Wiring Block**



**Figure 5-5. Assembling Wiring Block/Strain Relief**



**Figure 5-6. Strain Relief Housing/Plate Assy**

4. Push the wiring block/strain relief housing card onto the plug-in card connector (see Figure 5-7). Tighten the screws on each end of the housing.

5. The HP 3457 was shipped from the factory calibrated to its rear terminal assembly. After installing a plug-in card, you should recalibrate the HP 3457. A calibration procedure is in the HP 3457 Service Manual.

## **Removing a Plug-In Card**

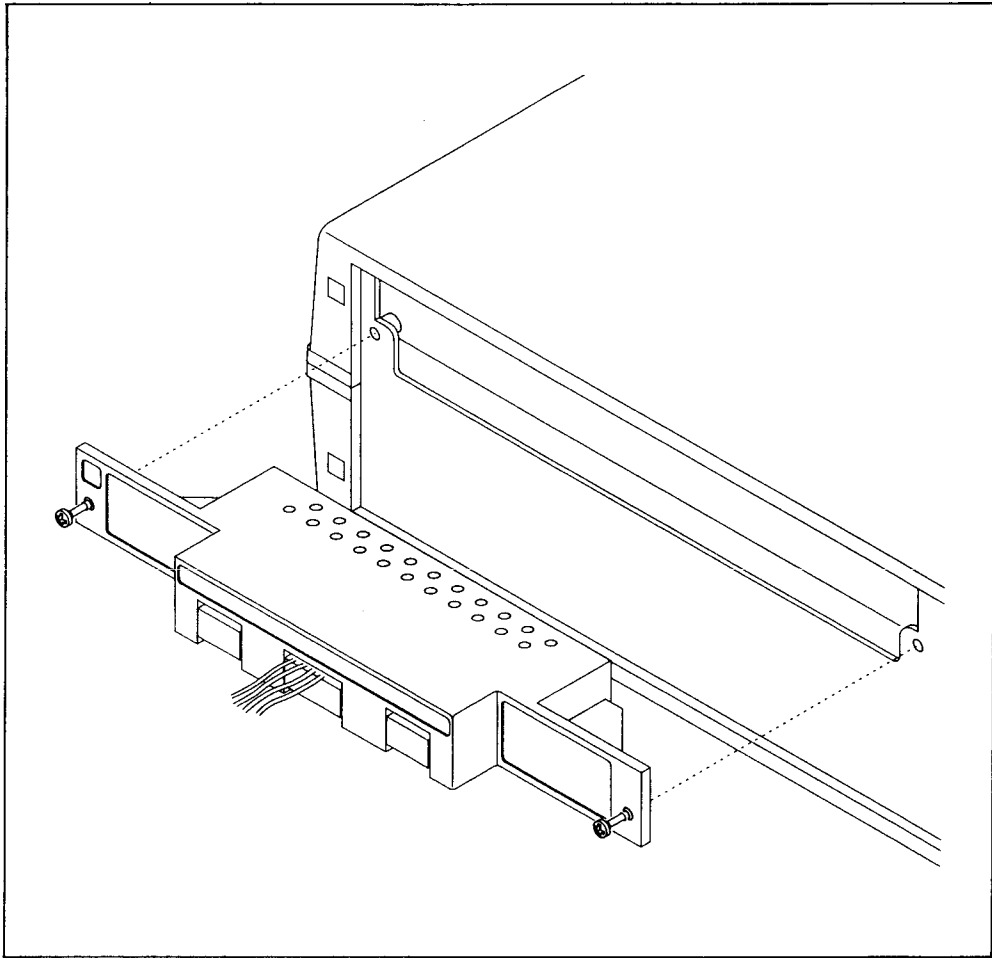
To remove a plug-in card, simply unfold the plastic ears. This releases the locking mechanism and pulls the card away from the mainframe connector. Now, place your index fingers into the holes in the card's metal shield and pull the card from the slot. You can now disconnect the wiring harness (refer to Figure 5-1 for details.)

---

### **NOTE**

*Do not touch the exposed connector on the plug-in card. Fingerprints reduce the impedance in high humidity conditions.*

---



**Figure 5-7. Installing Strain Relief/Wiring Block**

# The HP 44491 Armature Relay Multiplexer Card

The HP 44491 Armature Relay Multiplexer Card can be automatically configured into eight 2-wire input channels, four 4-wire input channels, or a combination of 2 and 4-wire channels. In addition, this card has two 2-wire channels that you can use as current inputs or actuator outputs.

---

## WARNING

*The HP 44491 Armature Relay Multiplexer Card uses latching relays. The state of these relays can only be altered under program control. This is an advantage in the sense that, under most conditions of failure, the relays will remain in whatever state your program has set them. However, in case of power or equipment failure, any application requiring a fail-safe method of ensuring that the circuits under control are in a known state must be provided by the installer.*

*In case of component failure, any voltage input to a plug-in card may be present on any other terminal on the plug-in card.*

---

## 2-Wire Channels

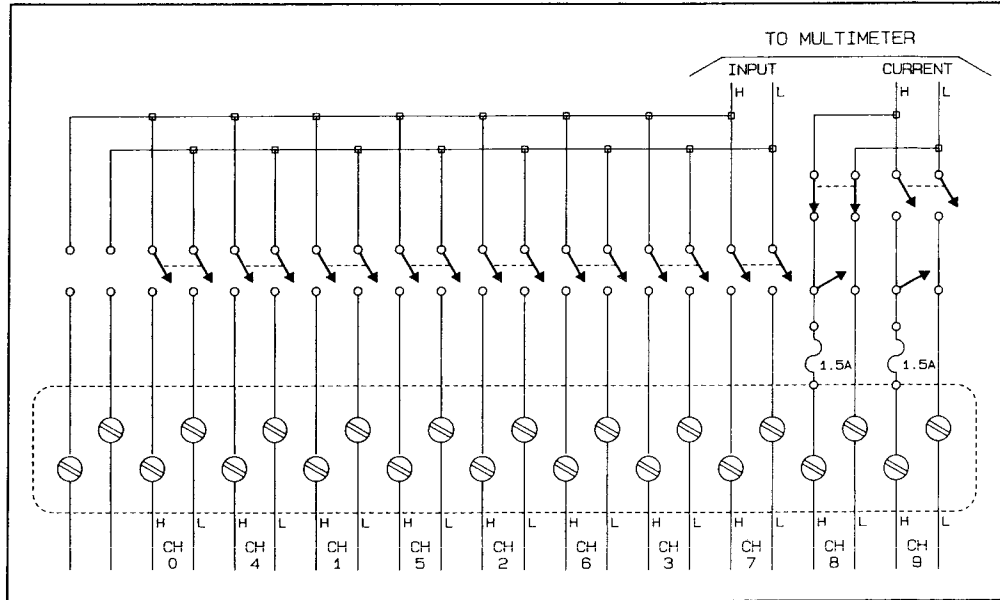
The standard 2-wire channels are numbered 0 through 7. You configure and select a standard 2-wire channel by using one of these channel numbers in the CHAN or SLIST command.

You can use channels 0 through 7 for DC voltage, AC voltage, AC+DC voltage, 2-wire ohms, frequency, or period measurements. However, you cannot measure current of any type on these channels. Each 2-wire channel has an H (hi) and L (lo) input. Figure 5-8 shows the 2-wire channels 0 through 7.

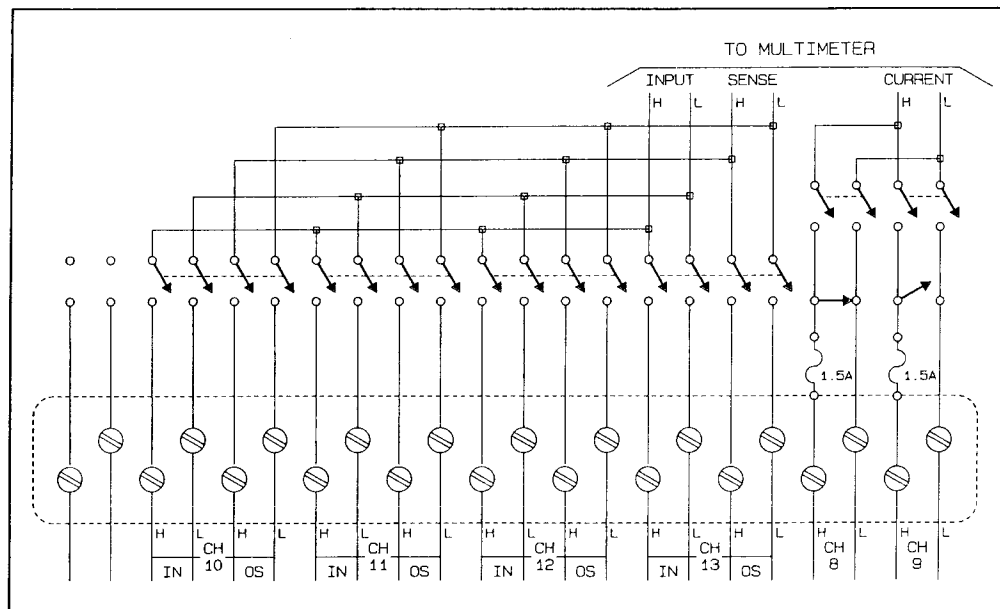
## 4-Wire Channels

The 4-wire channels are numbered 10 through 13. You configure and select a 4-wire channel by using one of these channel numbers in the CHAN or SLIST command.

You can use channels 10 through 13 only for 4-wire ohms measurements. Each 4-wire channel has an H (hi) and L (lo) INPUT, and an H and L SENSE input. Figure 5-9 shows the four possible 4-wire channels.



**Figure 5-8. 2-Wire Channels**



**Figure 5-9. 4-Wire Channels**

## Current Input and Actuator Channels

Channels 8 and 9 serve a dual purpose. They can be used to measure AC, DC, or AC+DC current, or they can be used as actuators. You configure and select a current input channel by using the CHAN or SLIST command. You configure and operate an actuator using the OPEN or CLOSE command, or by using the SLIST command and a special numbering scheme. (See SLIST command, later in this chapter.)

Each of these 2-wire channels has an H (hi) and L (lo) input. In Figure 5-8, channel 8 is shown as a current input. In Figure 5-9, channel 8 is shown as a closed actuator.

You can also measure frequency or period on channels 8 or 9 (when configured as current input) if you specify AC or AC+DC current as the frequency source (FSOURCE command).



### Wiring Block

The HP 44491's wiring block is shown in Figure 5-10.

For the 4-wire input channels, the upper (blue) lettering designates the channel numbers (10 through 13) and the IN (input) and  $\Omega S$  (sense) terminals. The lower (white) lettering shows the H (hi) and L (lo) terminals for input and sense.

For channels 8 and 9, the upper (white) lettering designates the channel numbers and the lower (white) lettering designates the H (hi) and L (lo) terminals.

For the standard 2-wire input channels, the lower (white) lettering designates both the channel numbers (0 through 7) and the H (hi) and L (lo) terminals.

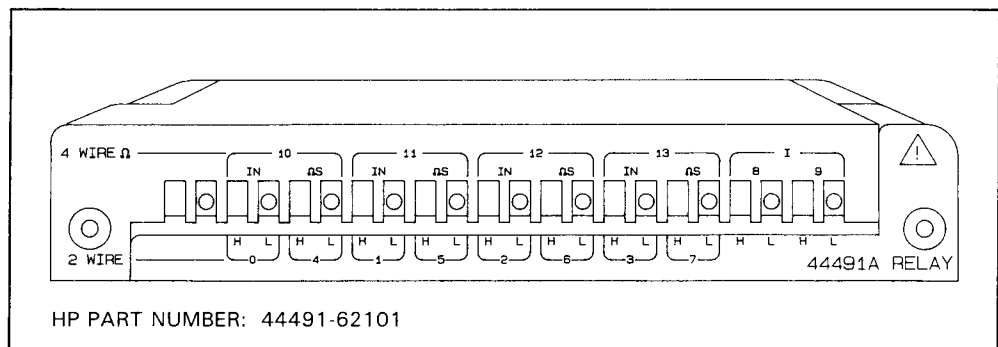


Figure 5-10. Wiring Block

---

## CAUTION

*The HP 44491's maximum terminal-to-terminal voltage limits are 250 VDC or 250 VAC RMS (350 V peak). The maximum terminal-to-chassis voltage is 450 V peak. Damage to the HP 44491 and possibly the HP 3457 will occur if any of the above limits are exceeded. The maximum current limits for channel 8 or 9 are 1.5 ADC at a maximum voltage of 30 VDC, or 1.5 AAC at a maximum voltage of 250 VAC (RMS).*

*In the event of a component failure, input signals on two or more channels may be connected together through the HP 44491. The resulting current flow may damage the HP 44491. To prevent damage, add external fuse protection when you have input signals that, when connected together, will produce more than 200 mA. When the inputs have different grounds, fuse both the high and low input lines.*

---

## Command List

The applicable commands for the HP 44491 are: CRESET, TERM, OPT?, CHAN, CHAN?, OPEN, CLOSE, SLIST, SLIST?, and SADV.

## CRESET Command

The CRESET (card reset) command opens all channels on the HP 44491 without changing the HP 3457's configuration.

**Syntax** CRESET

## Important Points

- A card reset is done whenever you apply power or when you execute the RESET command.
- The CRESET command opens any channel closed in a scan list. However, the CRESET command leaves the scan list intact and retains the present position in the list. The CRESET command executes a scan advance hold (SADV HOLD), stopping any scan sequence. If, for example, you execute a single scan advance after a card reset, an advance occurs to the next channel in the scan list.
- If you issue the CRESET command without a plug-in card in the HP 3457's rear slot, you'll get the BAD HEADER error.

**Example** OUTPUT 722;"CRESET" ! RESETS THE CARD IN THE REAR SLOT

**TERM Command** The TERM (terminal) command selects the HP 3457's input source. The HP 3457 then performs measurements using this source.

**Syntax** TERM *source*

**Parameters**

*source* The *source* parameter choices are:

<i>source</i> Parameter	Decimal Equiv.	Description
OPEN	0	Disconnects all input sources
FRONT	1	Selects front terminals
REAR	2	Selects rear terminals or plug-in card
SCANNER	2	Selects rear terminals or plug-in card

Power-on *source* = FRONT. Default *source* = FRONT.

**Important Points** • Both the REAR and SCANNER *source* parameters select whatever device is installed in the rear of the HP 3457. This can be either the rear terminal assembly or a plug-in card.

**Example** OUTPUT 722;"TERM SCANNER" ! SELECTS DEVICE IN REAR SLOT AS INPUT SOURCE

**OPT? Command** The OPT? (option?) command returns a number representing the type of device in the HP 3457's rear slot. The possible numbers are:

- 0 = rear terminals or nothing in rear slot
- 44491 = HP 44491 Armature Relay Multiplexer Card
- 44492 = HP 44492 Reed Relay Multiplexer Card

**Syntax** OPT?

**Important Points** • If you execute OPT? from the HP 3457's front panel, the result goes to the display. If you execute OPT? from the controller, the result goes to the HP 3457's output buffer in ASCII format.

**Example** 10 OUTPUT 722;"OPT?" ! RETURNS DEVICE NUMBER RESPONSE  
20 ENTER 722;A ! PUTS RESPONSE INTO VARIABLE A  
30 DISP A ! DISPLAYS A RESPONSE  
40 END



# CHAN Command

The CHAN (channel) command allows you to select an HP 44491 input channel on which to make measurements.

**Syntax** CHAN *channel*

## Parameters

***channel*** The *channel* parameter is the number of the channel you want to use for measurements. The choices are:

<i>channel</i> Parameter	Description
0 - 7	2-wire input channels
8 and 9	Current input channels
10 - 13	4-wire input channels

Power-on *channel* = none (no channel selected). Default *channel* = 0.

## Important Points

- To make a measurement on a plug-in card input channel, you must specify the plug-in card as the input source using the TERM command.
- For all input channels except 8 and 9, before the CHAN command closes a channel, it opens the previously selected channel.
- On channels 8 and 9 there are separate current input relays and actuator output relays. The interaction of these relays is as follows:

If the actuator relay is open and you specify that channel as a current input ( e.g. CHAN 8), the actuator relay closes, the current relay closes, then the actuator relay opens.

If the actuator relay is closed and you specify that channel as a current input (e.g. CHAN 8), the current relay closes then the actuator relay opens.

If a current input channel is closed and you execute CHAN to close another channel, the actuator on the current channel closes, the current relay opens, and then the new channel closes. The closed actuator shorts the two input lines providing a current path. The actuator remains closed until you open it (OPEN command), reselect that channel for a current measurement, or perform a card reset (CRESET).

- When CHAN selects a current input channel (channel 8 or 9) on the HP 44491, it closes the current input relays then opens the actuator on that channel. However, when CHAN selects a channel other than 8 or 9, it does not affect the state of the actuators.

- The CHAN command opens any previously selected scan list input channel. However, the scan list itself remains intact. If a specified SADV event occurs after a CHAN command, an advance is made to the next channel in the scan list.
- If you execute the CHAN command with no plug-in card in the HP 3457's rear slot, you'll get the BAD HEADER error.

### Examples

```

10 OUTPUT 722;"RESET"           ! RESETS THE HP 3457
20 OUTPUT 722;"TERM REAR"      ! SELECTS THE INPUT SOURCE
30 OUTPUT 722;"CHAN 2"         ! SELECTS CHANNEL 2
40 END

10 OUTPUT 722;"PRESET"         ! SEE FOLLOWING TEXT
20 OUTPUT 722;"TERM REAR"      ! SELECTS THE INPUT SOURCE
30 OUTPUT 722;"CHAN 2"         ! SELECTS CHANNEL 2
40 ENTER 722;A                 ! TRIGGERS & ENTERS READING
50 DISP A                      ! DISPLAYS READING
60 OUTPUT 722;"CHAN 3"         ! OPENS CH.2, CLOSES CH.3
70 ENTER 722;A                 ! TRIGGERS & ENTERS READING
80 DISP A                      ! DISPLAYS READING
90 END

```

Line 10 presets the HP 3457. Among other things, this does a card reset, selects DC voltage measurements, and sets the trigger mode to synchronous.

```

10 OUTPUT 722;"PRESET"         ! SEE FOLLOWING TEXT
20 OUTPUT 722;"TERM REAR"      ! SELECTS THE INPUT SOURCE
30 OUTPUT 722;"DCI"           ! SELECTS DC CURRENT
40 OUTPUT 722;"CHAN 8"         ! SELECTS CHANNEL 8
50 ENTER 722;A                 ! TRIGGERS & ENTERS READING
60 DISP A                      ! DISPLAYS READING
70 OUTPUT 722;"DCV"           ! SELECTS DC VOLTAGE
80 OUTPUT 722;"CHAN 1"         ! SEE FOLLOWING TEXT
90 ENTER 722;A                 ! TRIGGERS & ENTERS READING
100 DISP A                     ! DISPLAYS READING
110 END

```

Line 10 presets the HP 3457. Line 40 closes the channel 8 current input relay. Line 80 closes the channel 8 actuator, opens the channel 8 current relay, and then closes channel 1.

## CHAN? Command

The CHAN? (channel?) command returns the channel number of any presently selected plug-in card input channel.

**Syntax** CHAN?

### Important Points

- If you execute CHAN? from the HP 3457's front panel, the result goes to the display. If you execute CHAN? from the controller, the result goes to the HP 3457's output buffer in ASCII format.
- If no channel is selected, the CHAN? command returns -1 (minus 1).
- CHAN? does not reveal the state of an actuator channel (channel 8 or 9 on an HP 44491 card) unless that channel was closed by a scan list.

### Example

```
10 OUTPUT 722;"CHAN?"           ! RETURNS PRESENT CHANNEL NUMBER
20 ENTER 722;A                   ! PUTS RESPONSE IN COMPUTER'S A VARIABLE
30 DISP A                         ! DISPLAYS RESPONSE
40 END
```

## OPEN Command

The OPEN command opens actuator channel 8 or 9 on the HP 44491 plug-in card.

**Syntax** OPEN *actuator channel,control*

### Parameters

***actuator channel*** You specify the *actuator channel* parameter as the number of the channel you want to open (8 or 9).

Power-on *actuator channel* = all open.  
Default *actuator channel* = 8.

***control*** The *control* parameter enables or disables a 1.2 second delay. When enabled, the delay occurs after the actuator opens and keeps the actuator from closing until the delay period is over. This prevents possible relay damage caused by switching maximum or near maximum loads too fast. The *control* parameter choices are:

<i>control</i> Parameter	Decimal Equiv.	Description
OFF	0	No delay occurs
ON	1	Adds 1.2 second delay after every actuator opening

Power-on *control* = OFF.  
Default *control* = ON.

---

## CAUTION

To prevent contact damage, use the delay if you are switching currents greater than 25mA.

---

### Important Points

- You do not need to select the HP 44491 as the input source (TERM command) to open or close an actuator.
- The OPEN command opens a previously selected current input (e.g. CHAN 8) on the same channel.
- If you execute the OPEN command without an HP 44491 in the HP 3457's rear slot, you'll get the BAD HEADER error.

### Example

```
10 OUTPUT 722;"CLOSE 8"           ! CLOSSES CHANNEL 8
20 OUTPUT 722;"OPEN 8,ON"         ! OPENS CHANNEL 8 WITH DELAY
30 OUTPUT 722;"CLOSE 8"           ! CLOSSES CHANNEL 8
40 END
```

## CLOSE Command

The CLOSE command closes actuator channel 8 or 9 on the HP 44491 plug-in card.

**Syntax** CLOSE *actuator channel*

### Parameters

*actuator channel* You specify the *actuator channel* parameter as the number of the channel you want to close (8 or 9).

Power-on *actuator channel* = none (both channels open). Default *actuator channel* = 8.

### Important Points

- On channels 8 and 9 there are separate current input relays and actuator output relays. If a current input relay is closed and you execute the CLOSE command on the same channel, the actuator closes then the current relay opens.
- When power is applied, the HP 3457 performs a card reset which opens actuator channels 8 and 9 on the HP 44491.
- You do not need to specify the HP 44491 as the input source (TERM command) to close or open an actuator.
- If you execute the CLOSE command without a plug-in card in the HP 3457's rear slot, you'll get the BAD HEADER error.

### Example

```
OUTPUT 722;"CLOSE 8"           ! CLOSSES CHANNEL 8 ACTUATOR
```

## SLIST Command

The SLIST (scan list) command designates a series of plug-in card channels to scan and advances to the first channel in the list.

**Syntax** SLIST *channel 1,channel 2, . . . channel n*

### Parameters

***channel*** You specify each *channel* parameter as the channel number you want to scan. The HP 3457 scans the channels in the order in which you specify them. The HP 44491's standard channel numbers are 0 through 13. For channel 8 or 9, a special numbering scheme allows you to select a current input channel or to open or close an actuator:

Channel Number In Scan List	Description
8	Selects channel 8 as a current input
9	Selects channel 9 as a current input
14	Opens the channel 8 actuator with delay
15	Opens the channel 9 actuator with delay
16	Closes the channel 8 actuator
17	Closes the channel 9 actuator
18	Opens the channel 8 actuator without delay
19	Opens the channel 9 actuator without delay

Power-on *channel* = none (empty list). The default *channel* re-uses the previous list and advances to the first channel in that list.

---

### CAUTION

*To prevent contact damage, use the delay if you are switching currents greater than 25mA.*

---

### Important Points

- Use the SLIST command along with the SADV command. The SADV command specifies the event that causes an advance to the next channel in the list.
- To make a measurement on a scan list channel, you must specify the plug-in card as the input source using the TERM command. However, the plug-in card does not have to be specified as the input source to open or close an actuator.
- For input channels 0-7 and 10-13, the present channel opens and the next channel in the list closes whenever the specified scan advance (SADV) event occurs.

- The output (actuator) channels act independently from the input channels 0-7 and 10-13. That is, after a SADV event opens or closes an actuator, it stays opened or closed until instructed to change. Also, the previous input channel remains closed and the HP 3457 performs the specified measurement on that previous channel.
- On channels 8 and 9 there are separate current input relays and actuator output relays. The interaction of these relays is as follows:

If the actuator relay is open and you advance to that channel as a current input, the actuator relay closes, the current relay closes, then the actuator relay opens.

If the actuator relay is closed and you advance to that channel as a current input, the current relay closes then the actuator relay opens.

If a current input channel is closed and you advance to another channel, the actuator on the current channel closes, the current relay opens, then the next channel closes. The closed actuator shorts the two input lines providing a current path. The actuator remains closed until you open it (OPEN command), reselect that channel as a current input, or perform a card reset (CRESET).

- Advancing beyond the last channel in the scan list causes a wrap-around to the first channel in the list.
- From the controller, you can specify up to 20 channels in a scan list. From the HP 3457's front panel, however, the keyboard buffer limits the length to less than 20 channels.
- If you execute the SLIST command without a plug-in card in the HP 3457's rear slot, you'll get the BAD HEADER error.

**Example**

```
10 OUTPUT 722;"RESET"           ! RESETS THE HP 3457
20 OUTPUT 722;"TERM SCANNER"    ! SELECTS INPUT SOURCE
30 OUTPUT 722;"SADV AUTO"       ! SETS SADV TO AUTO
40 OUTPUT 722;"SLIST 3,5,16,6,14" ! SETS-UP SCAN LIST, STEPS TO 1ST CHANNEL
50 END
```

When the HP 3457 executes the SLIST command (line 40), it automatically advances to the first channel in the list (3). After that, each SADV event causes an advance to the next channel beginning with 5, advancing to 16, 6, 14, and back to 3. This sequence repeats until you stop it by setting the SADV to HOLD or by sending CRESET.

Notice that actuator designators 16 and 14 are included in the scan list. When advancing to 16, the channel 8 actuator closes. The previous input channel (channel 5) remains closed and measurements are made on it. When advancing to 6, the channel 8 actuator remains closed and the DC voltage measurement is made on channel 6. When advancing to 14, the channel 8 actuator opens. Again, the DC voltage measurement is made on the previously selected input channel (channel 6).

## SLIST? Command

The SLIST? (scan list?) command returns the total number of channels in a scan list when executed from remote or the actual channels in the list when executed from the HP 3457's keyboard.

**Syntax** SLIST?

### Important Points

- If you execute SLIST? from the HP 3457's front panel, the result goes to the display. If you execute SLIST? from the controller, the result goes to the HP 3457's output buffer in ASCII format.
- The SLIST? command returns 0 if there is no scan list.
- The display's buffer holds only 24 characters. It is possible to have more channels in the scan list than can be displayed.

### Example

```
10 OUTPUT 722;"SLIST?"           ! RETURNS THE NUMBER OF CHANNELS
20 ENTER 722;A                   ! ENTERS RESPONSE INTO VARIABLE A
30 DISP A                        ! DISPLAYS RESPONSE A
40 END
```

## SADV Command

The SADV (scan advance) command designates the event that causes an advance to the next channel in a scan list.

**Syntax** SADV *event*

### Parameters

*event* The *event* parameter choices are:

<i>event</i> Parameter	Decimal Equiv.	Description
HOLD	0	No advance occurs (use this to stop SADV AUTO)
SGL	1	Advances once and stays at that channel
AUTO	2	Advances after each measurement

Power-on *event* = HOLD. Default *event* = SGL.

- Important Points**
- Many of the “Important Points” under the SLIST command, also pertain to the SADV command.
  - If you execute the SADV command without a plug-in card in the HP 3457’s rear slot, you’ll get the BAD HEADER error.

**Example**

```

10 OUTPUT 722;"RESET"           ! RESETS THE HP 3457
20 OUTPUT 722;"TERM REAR"       ! SELECTS INPUT SOURCE
30 OUTPUT 722;"SADV AUTO"       ! SETS SCAN ADVANCE TO AUTO
40 OUTPUT 722;"SLIST 2,1,5,8,4"  ! SETS-UP SCAN LIST, ADVANCES TO FIRST CHANNEL
50 END

```

The RESET command (line 10) configures the HP 3457 to automatically make DC voltage measurements. When the HP 3457 executes the SLIST command (line 40), it automatically advances to the first channel in the list (2). After that, each SADV event causes an advance to the next channel beginning with 1, advancing to 5, 8, 4, and back to 2. This sequence repeats until you stop it by setting the SADV to HOLD or by sending the CRESET command.

## 2-Wire Measurements

Figure 5-11 is an example of a typical 2-wire measurement using the HP 44491. In this example, channels 0 through 7 are scanning DC voltage and channels 8 and 9 are scanning DC current.

**Example Program**

```

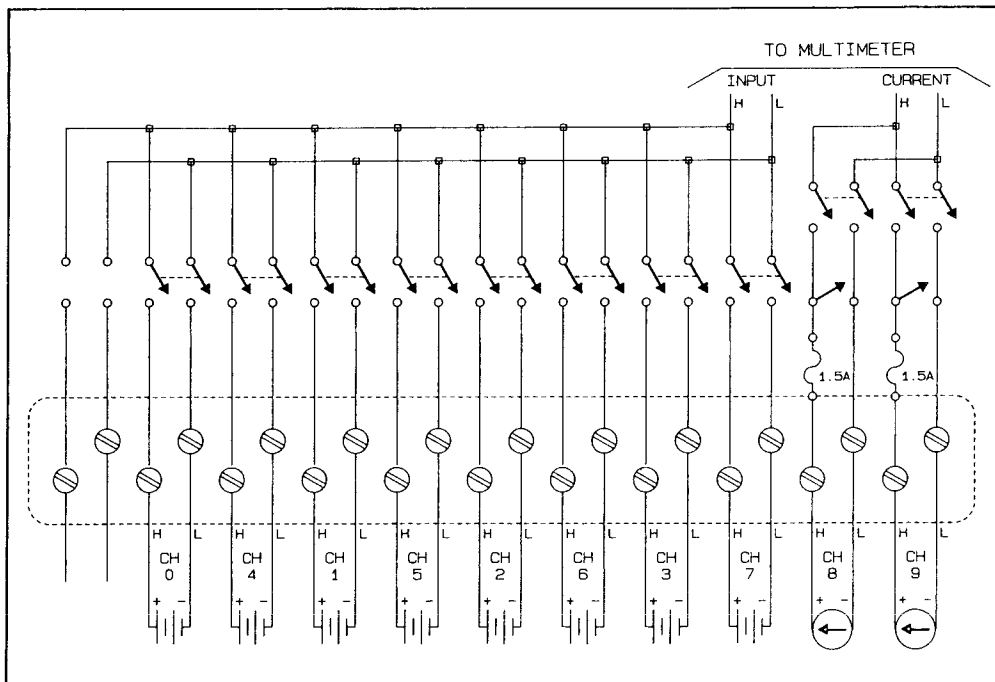
10 OUTPUT 722;"PRESET"
20 OUTPUT 722;"TERM SCANNER"
30 OUTPUT 722;"SLIST 0,1,2,3,4,5,6,7,8,9"
40 FOR I= 1 TO 8
50 ENTER 722;A
60 OUTPUT 722;"SADV SGL"
70 DISP A
80 NEXT I
90 OUTPUT 722;"DCI"
100 FOR I=9 TO 10
110 ENTER 722;A
120 OUTPUT 722;"SADV SGL"
130 DISP A
140 NEXT I
150 END

```



**Program Description**

Line 10 presets the HP 3457. Among other things, this performs a card reset, selects DC voltage measurements, and sets the trigger mode to synchronous. Line 20 selects the HP 44491 (or whatever is in the rear slot) as the HP 3457's input source. Line 30 establishes a scan list containing 10 channels and steps to the first channel in the list. Lines 40 and 80 set up a for/next loop that cycles through lines 50, 60, and 70 eight times. Line 50 initiates a synchronous trigger and enters the DC voltage reading into the controller's A variable. Line 60 sets the scan advance event to single which steps to the next channel in the list. Line 70 displays each measurement. Line 90 selects DC current measurements. Lines 100 and 140 set up a for/next loop that cycles through lines 110, 120, and 130 two times. Line 110 initiates a synchronous trigger and enters the DC current reading into the controller's A variable. Line 120 sets the scan advance event to single which steps to the next channel in the list. Line 130 displays each measurement.



**Figure 5-11. 2-Wire Measurements Example**

## 4-Wire Ohms Measurements

Figure 5-12 is an example of a typical 4-wire ohms measurement using the HP 44491. In this example, channels 10 through 13 are scanning 4-wire ohms.

**Example Program**

```

10 OUTPUT 722;"PRESET"
20 OUTPUT 722;"TERM SCANNER"
30 OUTPUT 722;"OHMF"
40 OUTPUT 722;"SLIST 10,11,12,13"
50 FOR I=1 TO 4
60 ENTER 722;A
70 OUTPUT 722;"SADV SGL"
80 DISP A
90 NEXT I
100 END
  
```

**Program Description**

Line 10 presets the HP 3457. Among other things, this performs a card reset, selects DC voltage measurements, and sets the trigger mode to synchronous. Line 20 selects the HP 44491 (or whatever is in the rear slot) as the HP 3457's input source. Line 30 selects 4-wire ohms measurements. Line 40 establishes a scan list containing channels 10 through 13 and steps to the first channel in the list. Lines 50 and 90 set up a for/next loop that cycles through lines 60, 70, and 80 four times. Line 60 initiates a synchronous trigger and enters each 4-wire ohms measurement into the controller's A variable. Line 70 sets the scan advance event to single which steps to the next channel in the list. Line 80 displays each measurement.

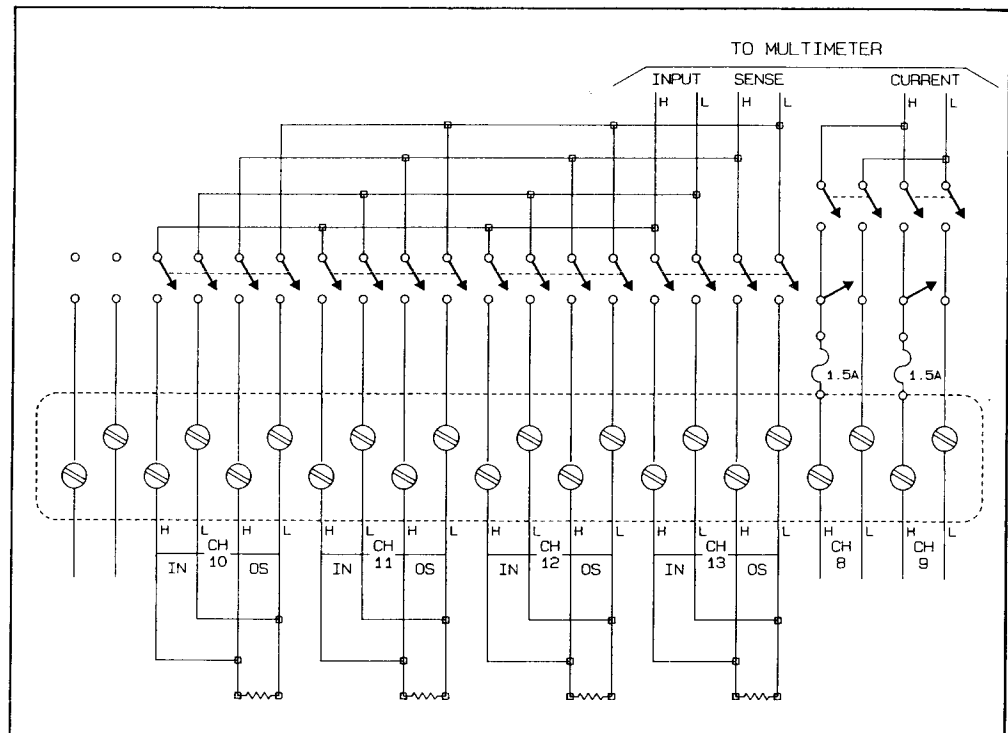


Figure 5-12. 4-Wire Measurements Example

## Using the Actuators

Figure 5-13 is an example showing the actuator channels switching low voltages. Channel 8 is connected to an external low voltage alarm system. To sound the alarm, simply execute the CLOSE 8 command. To turn off the alarm, execute the OPEN 8 command. Channel 9 is connected in series with a DC voltage and a device under test. When channel 9 is closed, the device is turned on.

Since each actuator channel can handle voltages up to 250 VAC at 1.5 AAC (RMS), they are suited for switching low power AC line operated devices such as small electronic test instruments. In Figure 5-14, the HP 44491 is shown operating a function generator.

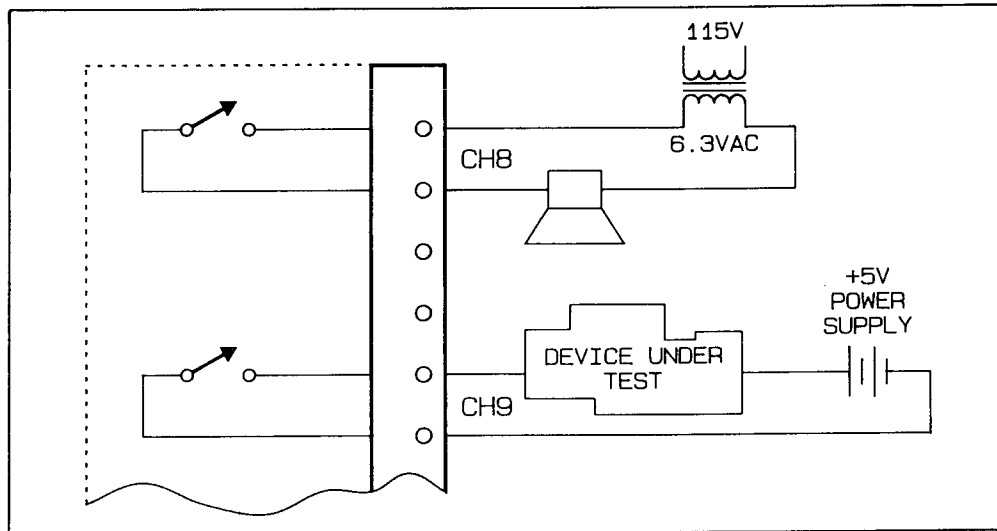


Figure 5-13. Actuator Switching Low Voltage

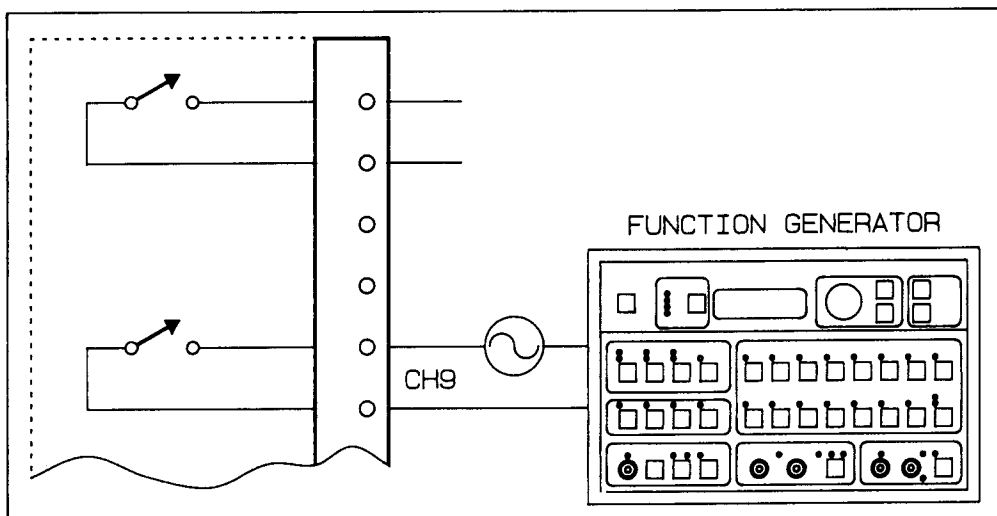


Figure 5-14. Actuator Switching Line Voltage

## Contact Protection

Provision is made on the HP 44491's circuit board for user-installed contact protection. Sometimes called a snubber network, this protection consists of an RC network and a varistor. Contact protection requirements vary greatly from one application to another. With no contact protection whatsoever, the HP 44491 will switch a maximum of 1.5 AAC at 250 VAC (RMS), or 30 VDC at 1.5 Adc. If you are switching inductive loads, or loads at or near the maximum levels, you should install contact protection.

A typical network is shown in Figure 5-15. The component values shown in Figure 5-15 are typical of general purpose snubber circuits. Other values may be better suited to a particular application.

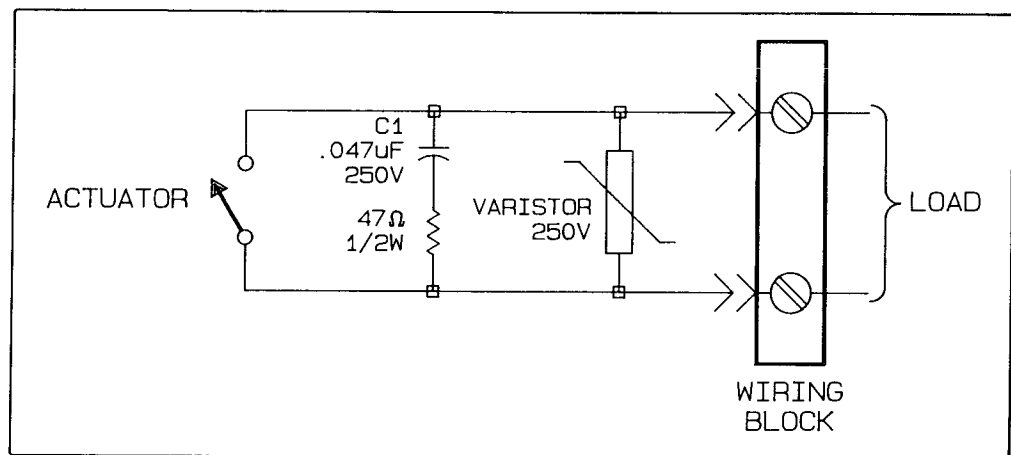


Figure 5-15. Contact Protection Network

## Designing RC Networks

Although many types of contact protection networks can be used, only RC networks and varistors are described here. In most cases, external contact protection (at or near the load) is also beneficial, especially with inductive loads.

The protection resistor R1 is selected as a compromise between two values. The minimum value of R1 is determined by the equation:

$$R1 = V/I_o = V/1.5 \quad \text{Equation 1}$$

Where V is the peak value of the supply voltage and I<sub>o</sub> is the maximum allowable relay current (1.5 amps AC or DC for the HP 44491).

The maximum value for R1 is usually made equal to the load resistance, R<sub>L</sub>. Therefore, the limits on R1 can be stated as:

$$V/I_o < R1 < R_L \quad \text{Equation 2}$$

The total circuit capacitance (C) must be large enough to prevent the peak voltage across the open relay contacts from exceeding 350 volts peak (250 VRMS = 350 V peak). The equation for determining the minimum allowable circuit capacitance is:

$$C \geq (I_p/350)^{2L} \quad \text{Equation 3}$$

Where L is the inductance of the load and  $I_p$  is the peak current which is equal to the peak voltage/RL.

The total circuit capacitance (C) is made up of the wiring capacitance plus the value of the protection network capacitor C1. Therefore, the minimum value for C1 is the value obtained for the total circuit capacitance (C) from Equation 3. In most cases, the actual value used for C1 should be substantially greater than the value calculated for C.

**Varistors** Just as contact protection circuits are important to suppress noise while relay contacts are opening and closing, transient protection should also be provided while the relay contacts are open. This is the purpose of the varistor. The varistor's voltage rating must be sufficient to handle the supply voltage. A 250 V-rated varistor can be purchased from Hewlett-Packard under the part number 0837-0227.

Figure 5-16 is a simplified schematic showing the protection components and their reference numbers (UC808, UC809, etc.). These reference numbers are printed on the HP 44491's printed circuit board and indicate the locations for the components.

Space is also provided on channels 4, 5, 6, and 7 of the HP 44491 for user designed and installed two-element low pass filters, high pass filters or resistive dividers. These components are also shown in Figure 5-16.

---

### CAUTION

*Use clean handling and anti-static procedures when removing, configuring, and installing a plug-in card. The plug-in cards as well as the HP 3457 mainframe contain components that are susceptible to damage from static electricity.*

---

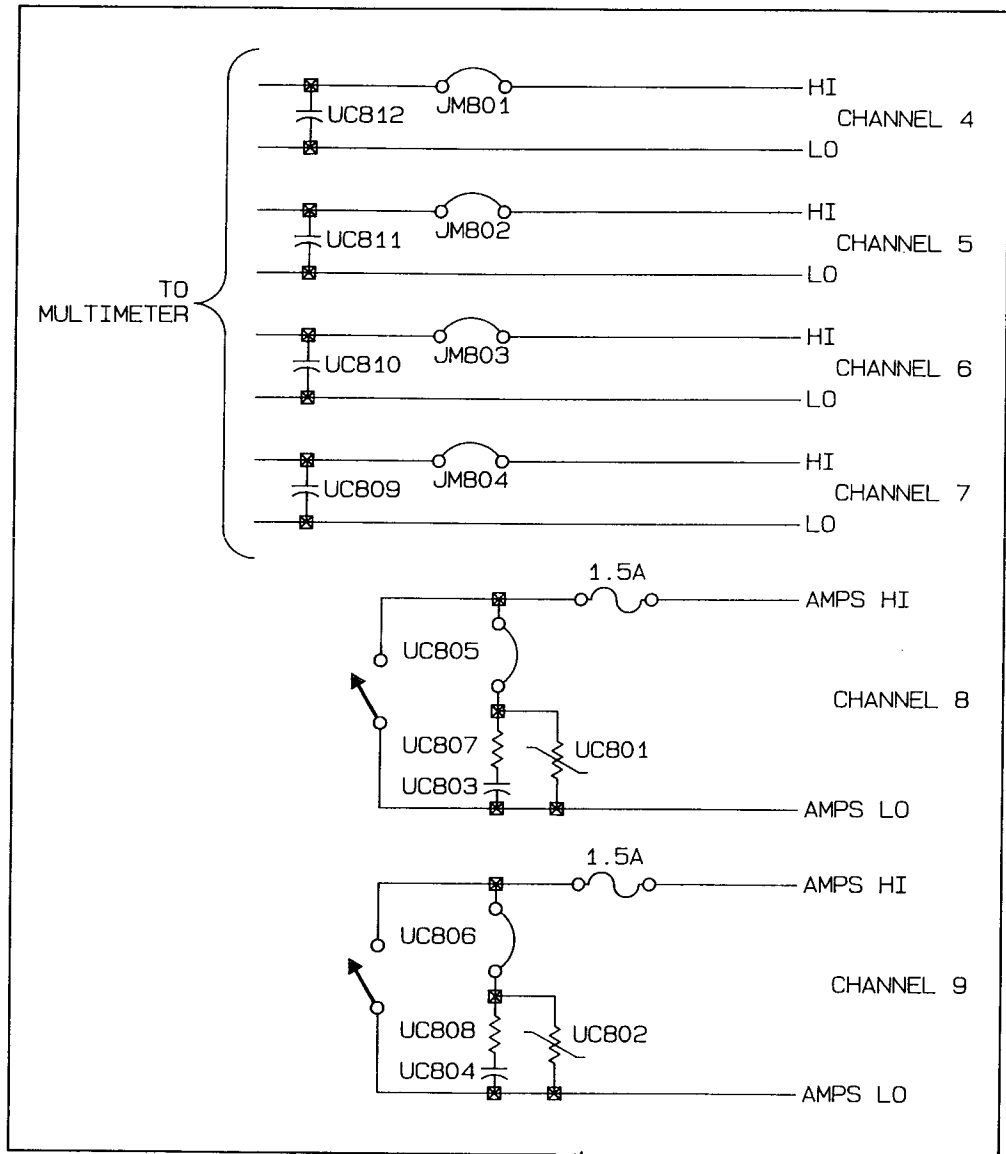
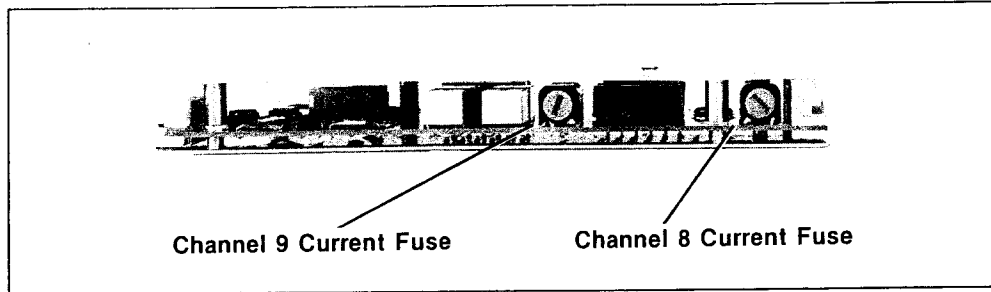


Figure 5-16. Added Networks

## Replacing a Current Fuse

Each of the current input channels (channels 8 and 9) are fuse protected. The fuse locations are shown in Figure 5-17. To replace a fuse, disconnect any external connections from the HP 44491, remove power from the HP 3457, and remove the HP 44491 from the HP 3457's rear slot. With a small flatblade screwdriver, rotate the fuse cap counterclockwise. Remove the fuse cap and blown fuse. Replace the fuse with a 1.5A 250V NTD fuse (HP part number 2110-0043).



**Figure 5-17. Current Fuse Locations**

## Specifications

The following table of specifications applies only to the HP 44491 plug-in card. The specifications are the performance standards or limits against which the card is tested. Do not exceed or surpass the specified limits.

Any changes to specifications because of manufacturing changes, design, or traceability to the National Bureau of Standards will be documented in a manual change supplement.

**Table 5-1. HP 44491 Specifications**

<p><b>Maximum input voltage (non-destructive):</b>          Between any two terminals, or between any 44491 terminal and any 3457 front terminal:          350 V peak, 250 VDC, 250 VAC RMS          Between any terminal and chassis: 450 V peak</p> <p><b>Maximum current on channel 8 or 9 (current input or actuator output):</b>          1.5 ADC at a maximum voltage of 30 VDC          1.5 AAC at a maximum voltage of 250 VAC (RMS).</p> <p><b>Thermal offset (channels 0 through 7):</b>          Less than <math>3\mu V</math></p> <p><b>Closed channel resistance (end of relay life):</b>          Less than <math>2\Omega</math></p> <p><b>Maximum Switching and Measurement Speed:</b>          33 channels per second</p>
---

## Accessories

HP accessory number 44493A is an extra wiring block and strain relief housing for use with the HP 44491.

# The HP 4492 Reed Relay Multiplexer Card

The HP 4492 Reed Relay Multiplexer Card can be thought of as a ten channel extension of the HP 3457's input terminals. You can use the HP 4492 as the HP 3457's input source for standard 2-wire DC voltage, AC voltage, AC + DC voltage, resistance, frequency and period measurements. You cannot use the HP 4492 for 4-wire ohms or for measuring any type of current.



## Channels

The HP 4492 has ten 2-wire channels numbered 0 through 9. All channels are *break-before-make*. That is, the HP 3457 disconnects the present channel before it connects the next channel.

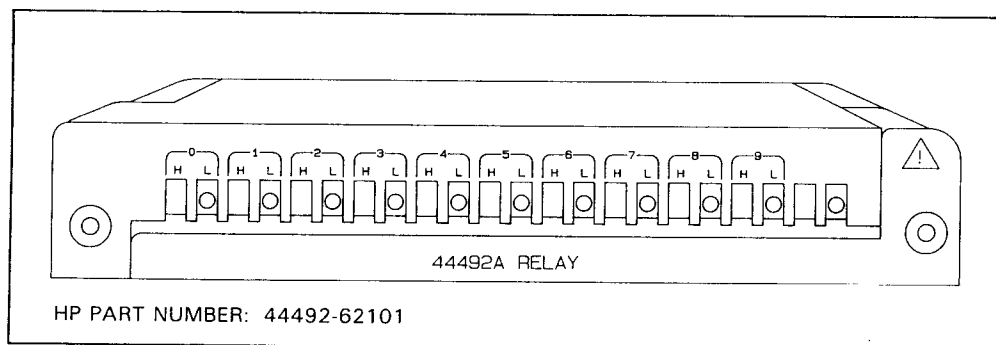
You select a channel for measurements using the CHAN or SLIST command. Each channel has a H (high) and a L (low) input. The HP 4492's wiring block is shown in Figure 5-18.

---

### NOTE

*Because of the HP 4492's relay contact protection circuitry, AC voltage measurements are limited to 100 KHz. Also, you cannot perform ohms measurements on the 30  $\Omega$  range with this plug-in card.*

---



**Figure 5-18. Wiring Block**



---

## CAUTION

*The HP 44492's maximum terminal-to-terminal voltage limits are 125 VDC or 88 VAC RMS (125 VAC peak). The maximum terminal-to-chassis voltage limits is 450 V peak.*

*In the event of a component failure, input signals on two or more channels may be connected together through the HP 44492. The resulting current flow may damage the HP 44492. To prevent damage, add external fuse protection when you have input signals that, when connected together, will produce more than 200 mA. When the inputs have different grounds, fuse both the high and low input lines.*

---

### Command List

The applicable commands for the HP 44492 are: CRESET, TERM, OPT?, CHAN, CHAN?, SLIST, SLIST?, and SADV.

### CRESET Command

The CRESET (card reset) command opens all channels on the HP 44492 without changing the HP 3457's configuration.

**Syntax** CRESET

### Important Points

- A card reset is done whenever you apply power or execute the RESET command.
- The CRESET command opens any channel closed by a scan list. However, the CRESET command leaves the scan list intact and retains the present position in the list. The CRESET command executes a scan advance hold (SADV HOLD), stopping any scan sequence. If, for example, you execute a single scan advance after a card reset, an advance occurs to the next channel in the scan list.
- If you issue the CRESET command without a plug-in card in the HP 3457's rear slot, you'll get the BAD HEADER error.

### Example

OUTPUT 722;"CRESET" ! RESETS THE CARD IN THE REAR SLOT

### TERM Command

The TERM (terminal) command selects the HP 3457's input source. The HP 3457 then performs measurements using this source.

**Syntax** TERM *source*

## Parameters

*source* The *source* parameter choices are:

<i>source</i> Parameter	Decimal Equiv.	Description
OPEN	0	Disconnects all input sources
FRONT	1	Selects front terminals
REAR	2	Selects rear terminals or plug-in card
SCANNER	2	Selects rear terminals or plug-in card

Power-on *source* = FRONT. Default *source* = FRONT.

### Important Points

- Both the REAR and SCANNER *source* parameters select whatever device is installed in the rear of the HP 3457. This can be either the rear terminal block or a plug-in card.

### Example

```
OUTPUT 722;"TERM SCANNER" ! SELECTS DEVICE IN REAR SLOT AS INPUT SOURCE
```

### OPT? Command

The OPT? (option?) command returns a number representing the type of device in the HP 3457's rear slot. The possible numbers are:

0 = rear terminals or nothing in rear slot  
44491 = HP 44491 Armature Relay Multiplexer Card  
44492 = HP 44492 Reed Relay Multiplexer Card

**Syntax** OPT?

### Important Points

- If you execute OPT? from the HP 3457's front panel, the result goes to the display. If you execute OPT? from the controller, the result goes to the HP 3457's output buffer in ASCII format.

### Example

```
10 OUTPUT 722;"OPT?"          ! RETURNS DEVICE NUMBER RESPONSE
20 ENTER 722;A                ! PUTS RESPONSE INTO VARIABLE A
30 DISP A                     ! DISPLAYS RESPONSE
40 END
```

## CHAN Command

The CHAN (channel) command allows you to select a plug-in card input channel on which to make measurements.

**Syntax** CHAN *channel*

### Parameters

***channel*** The *channel* parameter is the number of the channel you want to use for measurements. The HP 44492's channel numbers are 0 through 9.

Power-on *channel* = none (no channel selected). Default *channel* = 0.

### Important Points

- To make a measurement on a plug-in card input channel, you must specify the plug-in card as the input source using the TERM command.
- On the HP 44492, the CHAN command opens any previously selected channel before it closes another channel.
- The CHAN command opens any previously selected scan list input channel. However, the scan list itself remains intact. If a specified SADV event occurs after a CHAN command, the plug-in card advances to the next channel in the scan list.
- If you execute the CHAN command with no plug-in card in the HP 3457's rear slot, you'll get the BAD HEADER error.

### Example

```
10 OUTPUT 722;"RESET"      ! RESETS THE HP 3457
20 OUTPUT 722;"TERM REAR"  ! SELECTS THE INPUT SOURCE
30 OUTPUT 722;"CHAN 2"    ! SELECTS CHANNEL 2
40 END

10 OUTPUT 722;"PRESET"     ! SEE FOLLOWING TEXT
20 OUTPUT 722;"TERM REAR"  ! SELECTS THE INPUT SOURCE
30 OUTPUT 722;"CHAN 2"    ! SELECTS CHANNEL 2
40 ENTER 722;A            ! TRIGGERS & ENTERS READING
50 DISP A                 ! DISPLAYS READING
60 OUTPUT 722;"CHAN 3"    ! OPENS CH.2, CLOSES CH.3
70 ENTER 722;A            ! TRIGGERS & ENTERS READING
80 DISP A                 ! DISPLAYS READING
90 END
```

Line 10 presets the HP 3457. Among other things, this does a card reset,, selects DC voltage measurements, and sets the trigger mode to synchronous.

## CHAN? Command

The CHAN? (channel?) command returns the channel number of any presently selected plug-in card input channel.

**Syntax** CHAN?

- Important Points**
- If you execute CHAN? from the HP 3457's front panel, the result goes to the display. If you execute CHAN? from the controller, the result goes to the HP 3457's output buffer in ASCII format.
  - If no channel is selected, the CHAN? command returns -1 (minus 1).

**Example**

```
10 OUTPUT 722;"CHAN?"      ! RETURNS PRESENT CHANNEL NUMBER
20 ENTER 722;A             ! PUTS RESPONSE IN COMPUTER'S A VARIABLE
30 DISP A                  ! DISPLAYS RESPONSE
40 END
```

## SLIST Command

The SLIST (scan list) command designates a series of plug-in card channels to scan and advances to the first channel in the list.

**Syntax** SLIST *channel 1,channel 2, . . . channel n*

### Parameters

*channel* You specify each *channel* parameter as the channel number you want to scan. The HP 3457 scans the channels in the order in which you specify them. The channel numbers are 0 through 9 for the HP 44492.

Power-on *channel* = none (empty list). The default *channel* re-uses the previous list and advances to the first channel in that list.

- Important Points**
- Use the SLIST command along with the SADV command. The SADV command specifies the event that causes an advance to the next channel in the list.
  - To make a measurement on a scan list channel, you must specify the plug-in card as the input source using the TERM command.
  - Whenever the specified scan advance (SADV) event occurs, any previously selected channel opens and the next channel in the list closes.
  - Advancing beyond the last channel in the scan list causes a wrap-around to the first channel in the list.

- From the controller, you can specify up to 20 channels in a scan list. From the HP 3457's front panel, however, the keyboard buffer limits the length to less than 20 channels.
- If you execute the SLIST command without a plug-in card in the HP 3457's rear slot, you'll get the BAD HEADER error.

**Example**

```

10 OUTPUT 722;"RESET"           ! RESETS THE HP 3457
20 OUTPUT 722;"TERM SCANNER"    ! SELECTS INPUT SOURCE
30 OUTPUT 722;"SADV AUTO"       ! SETS SADV TO AUTO
40 OUTPUT 722;"SLIST 3,5,2,6,1"  ! SETS-UP SCAN LIST, STEPS TO 1ST CHANNEL
50 END

```

When the HP 3457 executes the SLIST command (line 40), it automatically advances to the first channel in the list (3). After that, each SADV event causes an advance to the next channel beginning with 5, advancing to 2, 6, 1, and back to 3. This sequence repeats until you stop it by setting the SADV to HOLD or by sending CRESET.

## SLIST? Command

The SLIST? (scan list?) command returns the total number of channels in a scan list when executed from remote or the actual channels in the list when executed from the HP 3457's keyboard.

**Syntax** SLIST?

### Important Points

- If you execute SLIST? from the HP 3457's front panel, the result goes to the display. If you execute SLIST? from the controller, the result goes to the HP 3457's output buffer in ASCII format.
- The SLIST? command returns 0 if there is no scan list.
- The display's buffer holds only 24 characters. It is possible to have more channels in the scan list than can be displayed.

**Example**

```

10 OUTPUT 722;"SLIST?"          ! RETURNS THE NUMBER OF CHANNELS
20 ENTER 722;A                 ! ENTERS RESPONSE INTO VARIABLE A
30 DISP A                      ! DISPLAYS RESPONSE
40 END

```

## SADV Command

The SADV (scan advance) command designates the event that causes an advance to the next channel in a scan list.

**Syntax** SADV *event*

### Parameters

*event* The *event* parameter choices are:

<i>event</i> Parameter	Decimal Equiv.	Description
HOLD	0	No advance occurs (use this to stop SADV AUTO)
SGL	1	Advances once and stays at that channel
AUTO	2	Advances after each measurement

Power-on *event* = HOLD. Default *event* = SGL

### Important Points

- The present channel opens and the next channel in the list closes whenever the specified SADV event occurs.
- Advancing beyond the last channel in the scan list causes a wrap-around to the first channel in the list.
- If you execute the SADV command without a plug-in card in the HP 3457's rear slot, you'll get the BAD HEADER error.

### Example

```
10 OUTPUT 722;"RESET"           ! RESETS THE HP 3457
20 OUTPUT 722;"TERM REAR"      ! SELECTS INPUT SOURCE
30 OUTPUT 722;"SADV AUTO"      ! SETS SCAN ADVANCE TO AUTO
40 OUTPUT 722;"SLIST 2,1,5,8,4" ! SETS-UP SCAN LIST, ADVANCES TO FIRST CHANNEL
50 END
```

The RESET command (line 10) configures the HP 3457 to automatically make DC voltage measurements. When the HP 3457 executes the SLIST command (line 40), it automatically advances to the first channel in the list (2). After that, each SADV event causes an advance to the next channel beginning with 1, advancing to 5, 8, 4, and back to 2. This sequence repeats until you stop it by setting the SADV to HOLD or by sending the CRESET command.

## Making 2-Wire Measurements

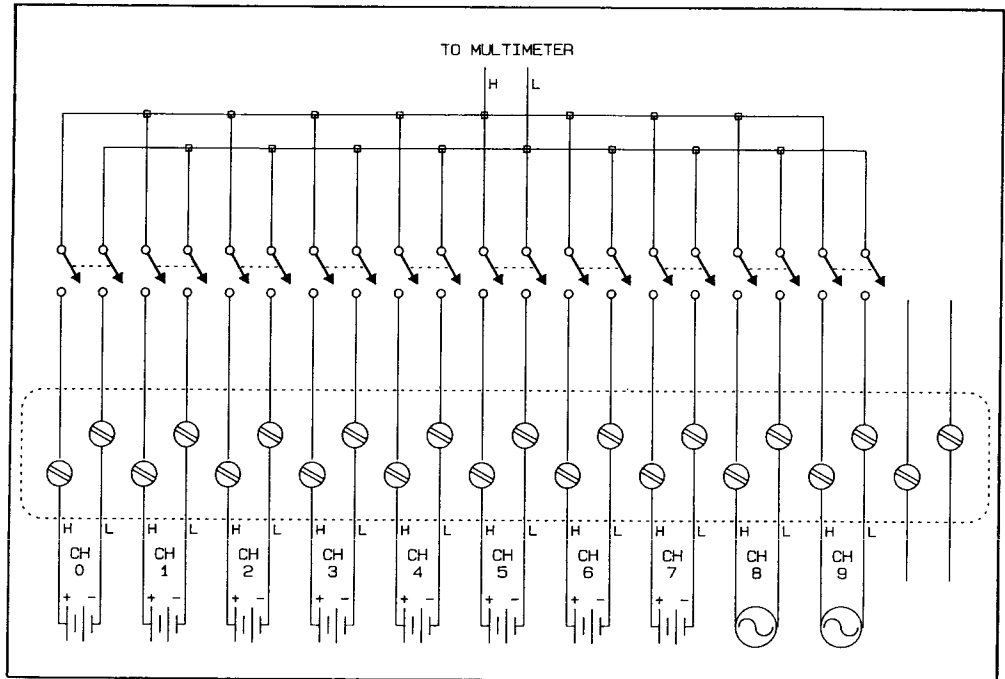
Figure 5-19 is an example of a typical 2-wire measurement using the HP 44492. In this example, channels 0 through 7 are scanning DC voltage and channels 8 and 9 are scanning AC voltage.

**Example Program**

```
10 OUTPUT 722;"PRESET"  
20 OUTPUT 722;"TERM SCANNER"  
30 OUTPUT 722;"SLIST 0,1,2,3,4,5,6,7,8,9"  
40 FOR I= 1 TO 8  
50 ENTER 722;A  
60 OUTPUT 722;"SADV SGL"  
70 DISP A  
80 NEXT I  
90 OUTPUT 722;"ACV"  
100 FOR I= 9 TO 10  
110 ENTER 722;A  
120 OUTPUT 722;"SADV SGL"  
130 DISP A  
140 NEXT I  
150 END
```

**Program Description**

Line 10 presets the HP 3457. Among other things, this performs a card reset, selects DC voltage measurements, and sets the trigger mode to synchronous. Line 20 selects the HP 44492 (or whatever is in the rear slot) as the HP 3457's input source. Line 30 establishes a scan list containing 10 channels and steps to the first channel in the list. Lines 40 and 80 set up a for/next loop that cycles through lines 50, 60, and 70 eight times. Line 50 initiates a synchronous trigger and enters each of the eight DC voltage readings into the controller's A variable. Line 60 sets the scan advance event to single which steps to the next channel in the list. Line 70 displays each measurement. Line 90 selects AC voltage measurements. Lines 100 and 140 set up a for/next loop that cycles through lines 110, 120, and 130 two times. Line 110 initiates a synchronous trigger and enters each AC voltage reading into the controller's A variable. Line 120 sets the scan advance event to single which steps to the next channel in the list. Line 130 displays each measurement.



**Figure 5-19. 2-Wire Measurement Example**

## Specifications

The following table of specifications applies only to the HP 44492 plug-in card. The specifications are the performance standards or limits against which the card is tested. Do not exceed or surpass the specified limits.

Any changes to specifications because of manufacturing changes, design, or traceability to the National Bureau of Standards will be documented in a manual change supplement.

**Table 5-2. HP 44492 Specifications**

<p><b>Maximum Input Voltage:</b> 125 Vdc, 88 VAC RMS, (125 VAC peak)</p> <p><b>Maximum voltage (terminal-to-chassis):</b> 450 V peak</p> <p><b>Thermal Offset:</b> Less than 3<math>\mu</math>V</p> <p><b>Closed Channel Resistance (end of relay life):</b> Less than 4<math>\Omega</math></p> <p><b>Maximum Switching and Measurement Speed:</b> 300 channels per second</p>
--

## Accessories

HP accessory number 44494A is an extra wiring block and strain relief housing for use with the HP 44492.



# INDEX

- % resolution parameter, 2-39, 2-45
- .5 digit, 2-17
- IE38, 2-35
- 2's complement binary coding, 3-33
- 2-wire:
  - channels, 5-8, 5-9
  - measurements, 2-6, 5-20, 5-35
- 2-wire ohms, 2-7, 3-12
  - command, 4-101
  - display, 2-7
  - example program, 5-20
  - measurement connections, 3-13
  - specifications, 1-12
- 4-wire:
  - channels, 5-8, 5-9
  - measurements, 5-22
- 4-wire ohms:
  - command, 4-104
  - display, 2-10
  - example program, 5-22
  - measurements, 2-10, 3-14, 3-15, 5-22
  - specifications, 1-12
- 4WΩ annunciator, 2-10, 3-57
- ? command, 3-42, 3-50, 4-165
- Abbreviated specifications, 1-11
- ABORTIO 7 (IFC), 4-168
- AC bandwidth command, 4-9
- AC current, 2-9
  - command, 4-16
  - display, 2-9
  - measurements, 3-10, 3-18
  - range vs. resolution, 3-19
  - specifications, 1-13
- AC line:
  - power requirements, 1-3
  - rejection, 3-5
  - voltage switch positions, 1-4
- AC power cable, 1-3
- AC voltage, 2-6
  - command, 4-19
  - display, 2-7
  - range vs. resolution, 3-10
  - specifications, 1-13
- AC + DC annunciator, 2-7, 2-9, 3-57
- AC + DC current, 2-9
  - command, 4-10
  - display, 2-9
  - measurements, 3-18
  - range vs. resolution, 3-19
- AC + DC voltage, 2-7,
  - command, 4-13
  - display, 2-7
  - measurements, 3-10
- ACAL, 3-51, 4-7
- ACBAND, 3-11, 4-9
- Accessories, 1-16, 5-27, 5-36
- ACDCI, 2-9, 2-38, 3-18, 4-10
- ACDCV, 2-7, 2-38, 3-10, 4-13
- ACI, 2-9, 2-38, 3-18, 4-16
- Actuator:
  - channels, 5-10, 5-23
  - switching line voltage, 5-23
  - switching low voltage, 5-23
- ACV, 2-6, 2-37, 3-10, 4-19
- A/D converter, 3-4, 3-5
- Added:
  - delay for function change, 3-45
  - delay for range change, 3-44
  - networks, 5-26
- Address
  - changing HP-IB, 2-33
  - codes, HP-IB, 1-6
  - command, 4-22
  - display, 2-2, 2-32
  - HP-IB, 1-6, 3-58
  - reading HP-IB, 2-32
- ADRS, 3-58
  - annunciator, 3-57
  - key, 2-32
- Alphabetic command directory, 2-19
- Analog to digital converter, 3-4, 3-5
- Annunciators, 2-2
- ANSI MC1.1, 1-1, 2-1
- Applying power, 2-1
- ARANGE, 3-6, 4-24
- Arm, trigger, 3-40
- Armature Relay Multiplexer Card, 5-8
- ASCII, 3-29, 3-34
- Assembling wiring block/strain relief, 5-5
- AUTO, 2-11, 3-41, 3-45
- Autocal
  - command, 4-7
  - display, 2-13
- AUTO CAL key, 2-12
- AUTOCAL REQUIRED error, 3-55
- Autorange command, 4-24
- Autorangeing, 2-10, 2-11,
- Autozero, 3-6
  - command, 4-27
  - query command, 4-28
- AUXERR?, 2-23, 2-37, 3-56, 4-25
- Auxiliary error register, 3-55
  - command, 4-25
- AZERO, 3-6, 3-48
- AZERO?, 3-6, 4-27, 4-28
- AZOFF annunciator, 3-57
- BACK SPACE key, 2-29
- BAD HEADER error, 3-54
- BAD PARAMETER error, 3-55
- BEEP, 2-21, 3-58, 3-59, 4-29
- Beeps and tones, 3-59
- Before applying power, 2-1
- Binary coding, two's complement, 3-33
- Block, wiring, 5-10
- Break-before-make, 1-2, 5-28
- Buffer:
  - input, 3-28
  - output, 3-29
- Buffering, Trigger, 3-42
- Buffers, 3-28
- CAL, 3-51, 4-30
- Calibration, 3-51
  - command, 4-30
  - number command, 4-32
- CALIBRATION error, 3-54
- CALL, 3-38, 3-48, 4-31
- CALNUM?, 3-51, 4-32
- Caps, replacement, 1-9
- Card:
  - inserting, 5-4
  - installation, 5-1
  - reset command, 4-37, 5-11, 5-29
- Cards, plug-in, 1-2, 3-2
- CHAN, 3-3, 4-33, 5-13, 5-31
- CHAN?, 3-3, 4-35, 5-15, 5-32
- Changing HP-IB Address, 2-33
- Channel command, 4-33, 5-13, 5-31
- Channel query command, 4-35, 5-15, 5-32
- Channels, 5-28
  - 2-wire, 5-8, 5-9
  - 4-wire, 5-8, 5-9
  - actuator, 5-10
  - current input, 5-10
- CLEAR (DCL or SDC), 4-169
- CLEAR key, 2-5, 2-24, 2-31
- Clear status byte command, 4-38
- Clearing display, 2-5, 2-31
- Clearing HP 3457, 3-7
- CLOSE, 3-3, 4-36, 5-16
- Closed channel resistance, 5-27, 5-37
- Codes, HP-IB address, 1-6
- Combined voltage, 3-16
- Comma delimiter, 2-19, 2-39, 4-4
- Command
  - executing, 2-21
  - list, 5-11, 5-29
  - selecting, 2-21
  - sending remote, 2-33
- Command directory, alphabetic, 2-19
- Commands
  - often-used, 2-36
  - plug-in cards, 3-3
  - query, 2-22
  - range, 2-44
  - sending, 4-3
- Common mode rejection specifications, 1-12
- Compensation, offset, 3-16
- Complete self-test, 2-3, 3-50
- Configuration keys, 2-12
- Configuring wiring block, 5-4
- Connecting:
  - HP-IB interface, 1-5
  - wire to wiring block, 5-5
  - wiring harness, 5-3
- Connections:
  - 2-wire measurement, 3-13
  - 4-wire ohms measurement, 3-15
  - current measurement, 3-17
  - external trigger, 3-41
  - frequency measurement, 3-20
  - period measurement, 3-20
  - rear terminal, 2-43
  - voltage measurement, 3-8
- Contact protection, 5-24
- Contents, shipping, 1-2
- Conventions, language, 4-3
- Converter, A/D, 3-4, 3-5
- Correcting mistakes, 2-29
- CRESET command, 3-3, 4-37, 5-11, 5-29
- CSB, 3-51, 4-38
- CTHRM, 2-49, 3-26
- Current fuse:
  - front terminal, 1-9
  - locations, 5-26
  - rear terminal, 1-10
  - replacing, 5-26
- Current:
  - AC, 2-9
  - AC + DC, 2-9
  - connections, 3-17
  - DC, 2-9
  - input channels, 5-10
  - measurements, 2-8
  - sourced, 3-12
- Damage, inspecting, 1-3
- Data, getting, 2-34
- DB, 3-25
- DBM, 3-25
- DC current, 2-9
  - command, 4-39
  - display, 2-9
  - measurements, 3-18
  - range vs. resolution, 3-18
  - specifications, 1-12
- DCI, 2-9, 2-38, 3-18, 4-39
- DC Voltage, 2-6
  - command, 4-42
  - display, 2-6
  - measurements, 3-9
  - specifications, 1-11
- DCV, 2-6, 2-37, 3-9, 3-47, 4-42
- Default:
  - delay times, 2-46, 3-44
  - values, 2-15
- Defaulting parameters, 2-40, 4-4
- DEGREE register, 3-26
- DELAY, 3-43, 3-46, 3-48, 4-45
- Delay, 2-45, 3-43
  - added for function change, 3-45
  - added for range change, 3-44
  - timer sequence, 3-43
- DELAY?, 3-43, 4-46
- Delay times, default, 3-44
- Delimiter, 2-13, 2-19
- Designing RC networks, 5-24
- Device Clear, 2-37, 3-7, 3-38, 3-42, 4-169
- DIAGNOSTIC, 4-47
- Digits displayed, 2-44
- DINT, 3-30, 3-35
  - scale factors, 3-31, 3-36

# INDEX (Cont'd)

- Directory, alphabetic command, 2-19
- Disconnecting wiring harness, 5-3
- DISP, 3-48, 3-58, 4-48
- Display:
  - address, 2-2
  - clearing, 2-5, 2-31
  - command, 4-48
  - control, 2-27, 3-58
  - test, 2-31
- LCD, 3-57
- Displayed digits, 2-44
- Displays, viewing long, 2-30
- Double integer, 3-30, 3-35
  - scale factors, 3-31, 3-36
- Down arrow key, 2-11
- EMASK, 3-48, 3-54, 3-55, 4-50
- END, 4-51
- ENT key, 2-14
- ENTER, 2-32
- Enter statements, 2-32
- Enter/output Statements, 2-32
- Entry, last, 2-31
- EOI, 4-51
- Equivalents, numeric, 2-15
- ERR annunciator, 2-2, 2-4, 2-37, 3-58
- ERR?, 2-22, 2-36, 3-54, 4-52
- ERROR:
  - bit, 3-53
  - key, 2-4, 3-54
- Error:
  - mask command, 4-50
  - query command, 4-52
  - register, 3-54
  - register, auxiliary, 3-55
  - register, reading, 2-4, 2-36
- Event, 3-41
  - external, 3-41
  - HOLD, 3-42
  - sample, 3-41
  - single, 3-42
  - synchronous, 3-42
  - timer, 3-43
  - trigger, 3-41
  - trigger arm, 3-40
- Examples, triggering, 3-46
- Executing command, 2-21
- Exponential:
  - notation, 2-17
  - parameters, 2-17
- EXT event, 3-41
- Extended ohms, 3-12
- External:
  - event, 3-41
  - trigger terminal, 3-41
- Extra:
  - information, viewing, 2-31
  - resolution, 3-27
- F10 - F58, 3-50, 4-54
- F50 - F58, 3-14
- Factory address setting, 1-6
- FIFO, 2-46, 2-47, 3-34
- FILTER, 3-25A
- First-in-first-out, 2-46, 2-47, 3-34
- Fixed impedance:
  - command, 4-56
  - query command, 4-57
- FIXEDZ, 3-9, 4-56
- FIXEDZ?, 3-9, 4-57
- Four-wire:
  - channels, 5-8, 5-9
  - measurements, 5-22
- Four-wire ohms, 3-14
  - command, 4-104
  - connections, 3-15
  - measurements, 2-10, 5-22
- FREQ, 2-7, 2-38, 3-21, 4-58
- Frequency, 2-7
  - command, 4-58
  - connections, 3-20
  - display 2-8,
  - measurements, 3-20
  - reference, 3-4
  - specifications, 1-14
- Frequency source command, 4-60
- Front panel, 3-56
  - operation, 2-3
- FRONT PANEL bit, 3-52
- Front terminal current fuse, 1-9
- FSOURCE, 3-20, 4-60
- FTHRM, 2-49, 3-26
- FUNC, 3-9, 3-12, 3-14, 3-18, 3-21, 4-61
- Function:
  - change, added delay for, 3-45
  - command, 4-61
- Functions:
  - additional, 2-43
  - math, 2-24
  - measurement, 2-37
- Fuse:
  - caps, 1-4, 1-9
  - FR terminal current, 1-9
  - holder, line power, 1-5
  - line power, 1-5, 1-9
  - rear terminal current, 1-10
- Fuses, replacement, 1-9, 5-26
- General shipping instructions, 1-11
- Getting Data, 2-34
- Go to local command, 4-170
- Grounding requirements, 1-3
- Group Execute Trigger, 3-38, 3-42, 4-174
- Half digit, 2-17, 3-57
- HARDWARE error, 2-4, 2-5, 2-22, 3-54
- Harness:
  - connecting, 5-3
  - disconnecting, 5-3
- Herstellerbescheinigung, 1-15
- HI/LOW bit, 3-52
- High pass filter, 5-25
- HIRES register, 3-5, 3-27
- HOLD, 2-11, 3-42
- Housing, strain relief, 5-4
- HP 3457:
  - clearing, 3-7
  - installation, 1-3
  - mounting, 1-6
  - operating, 1-6
  - overview, 1-1
  - resetting, 2-5
  - specifications, 1-11
- HP 44491, 1-2, 3-2, 5-8
  - specifications, 5-27
- HP 44492, 1-2, 3-2, 5-28
  - specifications, 5-36
- HP 44493, 5-27
- HP 44494, 5-36
- HP-IB:
  - address, 3-58
  - cables, 1-5
  - changing, 2-33
  - codes, 1-6
  - interface, 1-5
  - reading, 2-32
  - specifying, 1-6
- ID?, 3-58, 4-65
- Identity command, 3-58, 4-65
- IEEE 488-1978, 1-1, 2-1
- IFC command, 4-168
- Impedance, input, 3-9
- Implied read, 2-47
- INBUF, 3-47, 4-66
- Induced voltage, 3-16
- Information, viewing extra, 2-31
- Initial inspection, 1-2
- Input buffer, 3-28
  - command, 4-66
- Input:
  - impedances, 3-9
  - terminals, 3-1
- Inserting plug-in card, 5-4
- Inspection, initial, 1-2
- Installing:
  - HP 3457, 1-3
  - line power fuse, 1-5
  - plug-in card, 5-1, 5-2
  - strain relief/wiring block, 5-7
- Integer scale command, 4-68
- Integration time, 3-4
- Interconnection, HP-IB, 1-5
- Interface:
  - clear command, 4-168
  - HP-IB, 1-5
- ISCALE?, 3-31, 4-68
- Keyboard, 3-57
- Language conventions, 4-3
- LAST ENTRY, 2-30
- Last-in-first-out, 2-46, 2-47, 3-34
- LCD display, 3-57
- Lead resistance, 3-13
- LFREQ, 3-4, 4-70
- LFREQ?, 3-4, 4-71
- LIFO, 2-46, 2-47, 3-34
- Limits, line voltage, 1-4
- Line frequency:
  - command, 4-70
  - query command, 4-71
- Line power fuse, 1-5, 1-9
  - caps, 1-9
  - holder, 1-5
  - installing, 1-5
- Line power requirements, 1-3
- Line query command, 4-72
- Line switch, 2-1
- Line voltage:
  - actuator switching, 5-23
  - limits, 1-4
  - switches, 1-4
- LINE?, 3-4, 4-72
- LOCAL:
  - (GTL), 4-170
  - LOCKOUT (LLO), 4-171
- Local lockout command, 4-171
- LOCK, 3-48, 3-57, 4-73
- Long displays, viewing, 2-30
- Low pass filter, 5-25
- Low voltage, actuator switching, 5-23
- LOWER register, 3-27
- Maintenance, 1-9
- Manual ranging, 2-10, 2-11
- Manufacturer's declaration, 1-15
- MATH, 3-22, 4-74
  - annunciator, 2-25, 3-58
  - CONT, 2-25, 3-22
  - OFF, 2-25, 3-22
- Math:
  - functions, 2-24
  - keys, 2-24
  - operations, 3-22
  - turning off and on, 3-22
- MATH?, 4-77
- Max. input parameter, 2-38
- MAX register, 3-27
- Maximizing throughput, 3-50
- Maximum input current, 1-11, 3-1
  - HP 44491, 5-27
- Maximum input voltage, 1-11, 3-1
  - HP 44491, 5-27
  - HP 44492, 5-36
- Maximum offset voltages, 3-16
- Maximum switching speed:
  - HP 44491, 5-27
  - HP 44492, 5-37
- MCOUNT?, 4-78
- Mean, 2-26
- MEAN register, 3-27

# INDEX (Cont'd)

- Measurement connections:
  - 2-wire ohms, 3-13
  - 4-wire ohms, 3-15
  - current, 3-17
  - frequency, 3-20
  - period, 3-20
  - voltage, 3-8
- Measurement:
  - cycle, 3-40
  - functions, 2-37
  - terminals, 3-2
- Measurements:
  - 2-wire, 5-20, 5-21, 5-35, 5-36
  - 4-wire ohms, 2-10, 5-22,
  - AC & AC+DC voltage, 3-10
  - AC & AC+DC current, 3-18
  - current, 2-8, 3-17
  - DC current, 3-18
  - DC voltage, 3-9
  - frequency, 3-20
  - in general, 3-4
  - ohms, 3-12
  - period, 3-20
  - resistance, 3-12
  - standard 2-wire, 2-6
  - temperature, 2-49, 3-26
  - triggering, 2-41
  - voltage, 3-8
- MEM, 3-47, 3-48, 4-79
- Memory, 3-34
  - command, 4-79
  - count command, 4-78
  - format command, 4-81
  - reading, 2-46
  - size command, 4-83
  - size query command, 4-85
  - specifications, 1-14
  - state, 2-49
- Menu, 2-13
- MFORMAT, 3-34, 3-46, 3-48, 4-81
- MIN register, 3-27
- Mistakes, correcting, 2-29
- Mounting HP 3457, 1-6
- MRNG annunciator, 2-11, 3-38
- MSIZE, 3-34, 3-38, 3-40, 3-47, 3-48, 4-83
- MSIZE?, 3-34, 4-85
- Multiple parameters, 2-18
- Multiplexer card, 5-8, 5-28
- NDIG command, 2-16, 3-58, 4-86
- Network, contact protection, 5-24
- Networks:
  - added, 5-26
  - designing RC, 5-24
- NOT CALIBRATED error, 3-55
- NPLC, 3-4, 3-5, 4-88
- NPLC?, 3-4, 4-91
- NPLC vs. resolution, 3-5
- NRDGS, 2-18, 2-46, 3-41, 3-45, 4-92
- NRDGS?, 4-94
- NSAMP register, 3-27
- NULL, 2-25, 3-14, 3-22
- Number of digits command, 4-86
- Number of power line cycles:
  - command, 4-88
  - query command, 4-91
  - setting, 2-40
- Number of readings, 2-46
  - command, 4-92
  - query command, 4-94
  - STAT, 2-27
- Number, serial, 1-10
- Numeric:
  - equivalents, 2-15
  - parameters, 2-16
- OCOMP, 3-16, 4-95
- OCOMP?, 3-16, 4-96
- Offset compensation, 3-16
  - command, 4-95
  - query command, 4-96
- Offset register, 2-25, 3-14, 3-22, 3-23
- Offset voltage, 3-16
- OFORMAT, 3-29, 3-37, 3-48, 4-97
- Often-used commands, 2-36
- OHM, 2-7, 2-37, 4-101
- OHMF, 2-10, 2-38, 3-14, 4-104
- Ohms:
  - 4-wire, 2-10, 3-14, 5-22
  - 2-wire, 2-7, 3-12
  - range vs. resolution/current sourced, 3-12
- OPEN, 3-3, 5-15, 4-107
- Operating:
  - characteristics, 1-15
  - from remote, 2-32
  - front panel, 2-3
  - HP 3457, 1-6
- Operations, math, 3-22
- OPT?, 3-3, 5-12, 5-30, 4-109
- Option query command, 4-109, 5-12, 5-30
- Options, 1-16
- OUTPUT, 2-32
- Output:
  - buffer, 2-34, 3-29
  - format command, 4-97
  - statements, 2-32
- Overload, 2-35
- Overview (HP 3457), 1-1
- OVL, 2-35
- PARAMETER:
  - IGNORED error, 3-55
  - RANGE error, 3-55
  - REQUIRED error, 3-55
- Parameter, 4-4
  - defaulting, 2-40, 4-4
  - exponential, 2-17
  - multiple, 2-18
  - numeric, 2-16
  - range, 2-38
  - resolution, 2-39
  - selecting, 2-13
- Parameters, 2-21
- Pass/Fail, 3-27
- PAUSE, 3-38, 4-110
- PER, 2-8, 2-38, 3-21, 4-112
- PERC, 3-22
- PERCENT register, 3-24
- Percent, 3-24
- Period, 2-8
  - command, 4-112
  - connections, 3-20
  - display, 2-8
  - measurements, 3-20
  - specifications, 1-14
- PFAIL, 3-27
- PLCs, 2-40
- Plug-in cards, 1-2, 3-2
  - commands, 3-3
  - inserting, 5-4
  - installation, 5-1
  - removal, 5-6
- Power line cycles, 3-4
  - query command, 4-91
  - setting, 2-40
- Power:
  - applying, 2-1
  - before applying, 2-1
  - consumption, 1-3
  - line fuse caps, 1-9
  - line fuses, 1-9
- Power-on:
  - mode, 3-57
  - self-test, 2-2, 3-50
  - sequence, 2-2
  - state, 2-2, 3-6, 3-7
- POWER-ON bit, 3-52
- Power-on, reset, and preset states, 3-7
- Predefined states, 3-6
- PRESET, 2-42, 3-6, 4-114
- Preset state, 3-6, 3-7
- Presetting registers, 2-26
- PROGRAM COMPLETE bit, 3-52
- Protection, contact, 5-24
- Queries, 2-22, 2-23
- Question mark:
  - appending, 2-23
  - command, 4-165
- R, 4-115
- RANGE, 3-5, 3-6, 4-116
- Range, 3-6
  - command, 2-44, 4-116
  - parameter, 2-38
  - query command, 4-119
- Range change, added delay for, 3-44
- Range vs. resolution:
  - AC current, 3-19
  - AC voltage, 3-10
  - AC+DC current, 3-19
  - AC+DC voltage, 3-10
  - and current sourced, 3-12
  - DC current, 3-18
  - DC voltage, 3-9
  - ohms, 3-12
- RANGE?, 4-119
- Ranging:
  - auto, 2-10, 2-11
  - manual, 2-10, 2-11
- RC networks, designing, 5-24
- Reading:
  - error register, 2-4, 2-36
  - HP-IB Address, 2-32
  - memory, 2-46
  - rates, ACV, ACI, 1-14
  - rates, DCV, DCI, Ohms, 1-12
  - status register, 2-42
  - storage, 3-34
  - syntax diagram, 4-2
- Readings:
  - number of, 2-46
  - recalling, 2-47, 3-37
- READY bit, 3-52
- REAR annunciator, 2-44, 3-58
- Rear panel:
  - external trigger terminal, 3-41
  - voltmeter complete, 3-6
- Rear terminal, 2-43
  - assembly, 5-1
  - connections, 2-43
  - current fuse, 1-10
- Recall:
  - math command, 4-123
  - memory command, 4-125
  - state command, 4-129
- Recalling readings, 2-47, 3-37
- Reed relay multiplexer card, 5-28
- REF register, 3-25
- Reference frequency, 3-4
- Register:
  - auxiliary error, 3-55
  - error, 3-54
  - reading error, 2-4, 2-36
  - reading status, 2-42
  - status, 3-52
- Registers:
  - presetting, 2-26
  - STAT, 3-27
- Relay multiplexer card, 5-8, 5-28
- REM annunciator, 2-35, 3-57
- REMOTE, 4-172
- Remote command, sending, 2-33
- Remote operation, 2-32
- Removing plug-in card, 5-6
- Repair service, 1-10
- Replacement power line fuses and caps, 1-9
- Replacing:
  - current fuse, 5-26
  - fuses, 1-9
- Request service command, 4-127
- Requirements:
  - AC line power, 1-3
  - grounding, 1-3

## INDEX (Cont'd)

- RES register, 3-25
- RESET, 2-5, 2-37, 3-6, 4-120
- Reset:
  - command, 4-120
  - state, 3-6
- Resetting HP 3457, 2-5
- Resistance measurements, 3-12
- Resistive divider, 5-25
- Resolution, 3-5
  - extra, 3-27
  - parameter, 2-39
  - vs. NPLC, 3-5
  - vs. range, AC current, 3-19
  - vs. range, AC voltage, 3-10
  - vs. range, AC + DC current, 3-19
  - vs. range, AC + DC voltage, 3-10
  - vs. range, and current sourced, 3-12
  - vs. range, DC current, 3-18
  - vs. range, DC voltage, 3-9
  - vs. range, ohms, 3-12
- REV?, 4-122
- Revision command, 4-122
- RMATH, 3-22, 4-123
- RMEM, 2-47, 3-37, 4-125
- RMS, 3-25B
- RMS to DC converter, 3-19
- RQS, 3-48, 3-51, 4-127
- RSTATE, 2-49, 3-40, 4-129
- RTD temperature sensor, 3-16
- SADV, 3-3, 4-131, 5-19, 5-34
- Sample event, 3-41
- SCALE, 3-23
  - register, 3-23
- Scale factors:
  - DINT, 3-31
  - DINT, 3-36
  - SINT, 3-30
  - SINT, 3-35
- Scan advance command, 4-131, 5-19, 5-34
- Scan list:
  - command, 4-135, 5-17, 5-32
  - query command, 4-137, 5-19, 5-33
- SCRATCH, 4-133
- SDEV register, 3-27
- SECURE, 4-134
- Selected device clear, 3-7, 3-38, 3-42, 4-169
- Selecting:
  - command, 2-21
  - parameter, 2-13
- Self-test, 2-36
  - command, 4-155
  - complete, 2-3, 3-50
  - display 2-3, 2-4
  - power-on, 2-2, 3-50
- Sending commands, 4-3, 2-33
- Serial number, 1-10
- Serial poll command, 4-173
- SERVICE REQUEST bit, 3-53
- Service request command, 4-140
- Setting line voltage switches, 1-4
- Setting power line cycles, 2-40
- SGL, 3-45
  - event, 3-42
  - trigger, 2-41
- SHIFT annunciator, 2-3, 3-58
- Shift key, 2-3
- Shipping:
  - contents, 1-2
  - instructions, 1-11
- Shunt resistor, 3-18, 3-19
- Single:
  - event, 3-42
  - integer, 3-29, 3-35
  - integer scale factors, 3-30, 3-35
  - real, 3-31, 3-36
  - trigger, 2-41
- SINT, 3-29, 3-35
  - scale factors, 3-30, 3-35
- SLIST, 3-3, 4-135
  - command, 5-17, 5-32
- SLIST? command, 3-3, 4-137, 5-19, 5-33,
- SMATH, 3-22, 4-138
- SMPL annunciator, 2-2, 2-40, 2-41, 2-45, 3-57
- Space delimiter, 2-13
- Specifications:
  - HP 3457, 1-11
  - HP 44491, 5-27
  - HP 44492, 5-36
- Specifying HP-IB address, 1-6
- SROLL, 3-51, 4-173
- SREAL, 3-31, 3-36
- SRQ, 3-51, 3-57, 4-140
  - annunciator, 3-57
  - interrupt, 3-47
- SSTATE, 2-49, 3-40, 4-141
- Standard 2-wire measurements, 2-6
- Standard:
  - deviation, 2-27
  - queries, 2-22
- STAT, 3-27
- State:
  - memory, 2-49
  - power-on, 2-2, 3-6
  - preset, 3-6
  - reset, 3-6
  - storage, 3-40
- States, predefined, 3-6
- Statistics, 2-26, 3-27
- Status:
  - byte query command, 4-143
  - register, 2-42, 3-52
- STB?, 2-42, 3-51, 4-143
- Storage:
  - reading, 3-34
  - state, 3-40
  - subprogram, 3-38
- Store:
  - math command, 4-138
  - state command, 4-141
- Strain relief:
  - assembling, 5-5
  - installing, 5-7
  - housing, 5-4
  - housing/plate assembly, 5-6
  - installing, 5-7
- SUB, 3-38, 3-48, 4-145
- SUBEND, 3-38, 3-48, 4-147
- Subprogram:
  - command, 4-145
  - end command, 4-147
  - storage, 3-38
- Switch positions, line voltage, 1-4
- Switches, line voltage, 1-4
- SYN, 3-45
  - event, 3-42
  - trigger, 2-41
- Synchronous:
  - event, 3-42
  - trigger, 2-41
- Syntax diagram, reading, 4-2
- SYNTAX error, 3-54
- T, 4-148
- TARM, 3-40, 3-45, 3-46, 3-48, 4-149
- TARM?, 3-40
- TBUFF, 4-152A
- Temperature measurements, 2-49, 3-26
- TERM, 2-44, 3-1, 4-153, 5-12, 5-29
- TERM?, 2-24, 3-1, 4-154
- Terminal:
  - assembly, rear, 5-1
  - command, 4-153, 5-12, 5-29
  - external trigger, 3-41
  - query command, 4-154
  - rear connections, 2-43
- Terminals:
  - input, 3-1
  - measurement, 3-2
  - rear, 2-43
- TEST, 2-3, 2-36, 3-50, 4-155
- Thermal offset:
  - HP 44491, 5-27
  - HP 44492, 5-36
- Thermistor, 2-49, 3-26
- Throughput, maximizing, 3-50
- Time, integration, 3-4
- TIMER, 3-43, 3-46, 4-157
- TIMER?, 3-43, 4-159
- Timer/delay sequence, 3-43
- Timer query command, 4-159
- Times, default delay, 3-44
- Tips, triggering, 3-45
- TONE, 3-58, 4-160
- Tone command, 4-160
- Tones, 3-59
- TRIG, 3-41, 3-45, 4-161
- TRIG?, 3-41, 4-164
- TRIGGER:
  - (GET), 4-174
  - 7, 3-46
  - TOO FAST error, 3-54
- Trigger:
  - command, 4-161
  - event, 3-41
  - query command, 4-164
  - single, 2-41
  - synchronous, 2-41
- Trigger arm:
  - command, 4-149
  - event, 3-40
  - query command, 4-152
- Trigger Buffering, 3-42
- Triggering, 3-40
  - examples, 3-46
  - measurements, 2-41
  - tips, 3-45
- Turning math off and on, 3-22
- Two's complement binary coding, 3-33
- Two wire:
  - channels, 5-8, 5-9
  - measurements, 2-6, 5-20, 5-35
- Two-wire ohms, 3-12
  - command, 4-101
  - measurement connections, 3-13
- Up arrow key, 2-11
- UPPER register, 3-27
- Values, default, 2-15
- Varistor, 5-25
- Viewing:
  - extra information, 2-31
  - long displays, 2-30
- Voltage:
  - AC, 2-6
  - AC + DC, 2-7
  - DC, 2-6
  - limits, line, 1-4
  - maximum offset, 3-16
  - measurement connections, 3-8
- Voltmeter complete, 3-6
- Wire, connecting to wiring block, 5-5
- Wiring block, 5-10, 5-28
  - assembling, 5-5
  - configuring, 5-4
  - connecting wire, 5-5
  - installing, 5-7
- Wiring harness:
  - connecting, 5-3
  - disconnecting, 5-3
- Zero reading, 3-6

# SALES & SUPPORT OFFICES

Arranged alphabetically by country

1



## Product Line Sales/Support Key

### Key Product Line

- A Analytical
- CM Components
- C Computer Systems Sales only
- CH Computer Systems Hardware Sales and Services
- CS Computer Systems Software Sales and Services
- E Electronic Instruments & Measurement Systems
- M Medical Products
- MP Medical Products Primary SRO
- MS Medical Products Secondary SRO
- P Personal Computation Products
- \* Sales only for specific product line
- \*\* Support only for specific product line

**IMPORTANT:** These symbols designate general product line capability. They do not insure sales or support availability for all products within a line, at all locations. Contact your local sales office for information regarding locations where HP support is available for specific products.

*HP distributors are printed in italics.*

## HEADQUARTERS OFFICES

If there is no sales office listed for your area, contact one of these headquarters offices.

### NORTH/CENTRAL AFRICA

Hewlett-Packard S.A.  
7, Rue du Bois-du-Lan  
CH-1217 MEYRIN 2, Switzerland  
Tel: (022) 83 12 12  
Telex: 27835 hpse  
Cable: HEWPACKSA Geneve

### ASIA

Hewlett-Packard Asia Ltd.  
6th Floor, Sun Hung Kai Centre  
30 Harbour Rd.  
G.P.O. Box 795

### HONG KONG

Tel: 5-832 3211  
*After Jan. 1, 1984*  
47th Floor, China Resources Bldg.  
26 Harbour Rd., Wanchai

### HONG KONG

Telex: 66678 HEWPA HX  
Cable: HEWPACK HONG KONG

### CANADA

Hewlett-Packard (Canada) Ltd.  
6877 Goreway Drive  
MISSISSAUGA, Ontario L4V 1M8  
Tel: (416) 678-9430  
Telex: 610-492-4246

### EASTERN EUROPE

Hewlett-Packard Ges.m.b.h.  
Liebigasse 1  
P.O.Box 72  
A-1222 VIENNA, Austria  
Tel: (222) 2365110  
Telex: 1 3 4425 HEPA A

### NORTHERN EUROPE

Hewlett-Packard S.A.  
Uilenstede 475  
P.O.Box 999  
NL-1180 AZ AMSTELVEEN  
The Netherlands  
Tel: 20 437771

### SOUTH EAST EUROPE

Hewlett-Packard S.A.  
7, Rue du Bois-du-Lan  
CH-1217 MEYRIN 2, Switzerland  
Tel: (022) 83 12 12  
Telex: 27835 hpse  
Cable: HEWPACKSA Geneve

### OTHER EUROPE

Hewlett-Packard S.A.  
P.O. Box  
150, Rte du Nant-D'Avril  
CH-1217 MEYRIN 2, Switzerland  
Tel: (022) 83 8111  
Telex: 22486 hpsa  
Cable: HEWPACKSA Geneve

### MEDITERRANEAN AND MIDDLE EAST

Hewlett-Packard S.A.  
Mediterranean and Middle East  
Operations  
Atrina Centre  
32 Kifissias Ave.  
Paradissos-Amarousion, ATHENS  
Greece  
Tel: 682 88 11  
Telex: 21-6588 HPAT GR  
Cable: HEWPACKSA Athens

### EASTERN USA

Hewlett-Packard Co.  
4 Choke Cherry Road  
ROCKVILLE, MD 20850  
Tel: (301) 258-2000

### MIDWESTERN USA

Hewlett-Packard Co.  
5201 Tollview Drive  
ROLLING MEADOWS, IL 60008  
Tel: (312) 255-9800

### SOUTHERN USA

Hewlett-Packard Co.  
2000 South Park Place  
P.O. Box 105005  
ATLANTA, GA 30348  
Tel: (404) 955-1500

### WESTERN USA

Hewlett-Packard Co.  
3939 Lankershim Blvd.  
P.O. Box 3919  
LOS ANGELES, CA 91604  
Tel: (213) 506-3700

### OTHER INTERNATIONAL AREAS

Hewlett-Packard Co.  
Intercontinental Headquarters  
3495 Deer Creek Road  
PALO ALTO, CA 94304  
Tel: (415) 857-1501  
Telex: 034-8300  
Cable: HEWPACK

### ANGOLA

*Telecira*  
Empresa Técnica de Equipamentos  
R. Barbosa Rodrigues, 41-I DT.  
Caixa Postal 6487  
LUANDA  
Tel: 355 15,355 16  
E,P

### ARGENTINA

Hewlett-Packard Argentina S.A.  
Avenida Santa Fe 2035  
Martinez 1640 BUENOS AIRES  
Tel: 798-5735, 792-1293  
Telex: 17595 BIONAR  
Cable: HEWPACKARG  
A,E,CH,CS,P  
*Biotron S.A.C.I.M. e I.*  
Av Paseo Colon 221, Piso 9  
1399 BUENOS AIRES  
Tel: 30-4846, 30-1851  
Telex: 17595 BIONAR  
M

### AUSTRALIA

#### Adelaide, South Australia Office

Hewlett-Packard Australia Ltd.  
153 Greenhill Road  
PARKSIDE, S.A. 5063  
Tel: 272-5911  
Telex: 82536  
Cable: HEWPARD Adelaide  
A\*,CH,CM,,E,MS,P

#### Brisbane, Queensland Office

Hewlett-Packard Australia Ltd.  
10 Payne Road  
THE GAP, Queensland 4061  
Tel: 30-4133  
Telex: 42133  
Cable: HEWPARD Brisbane  
A,CH,CM,E,M,P

#### Canberra, Australia Capital Territory Office

Hewlett-Packard Australia Ltd.  
121 Wollongong Street  
FYSHWICK, A.C.T. 2609  
Tel: 80 4244  
Telex: 62650  
Cable: HEWPARD Canberra  
CH,CM,E,P

#### Melbourne, Victoria Office

Hewlett-Packard Australia Ltd.  
31-41 Joseph Street  
BLACKBURN, Victoria 3130  
Tel: 895-2895  
Telex: 31-024  
Cable: HEWPARD Melbourne  
A,CH,CM,CS,E,MS,P

#### Perth, Western Australia Office

Hewlett-Packard Australia Ltd.  
261 Stirling Highway  
CLAREMONT, W.A. 6010  
Tel: 383-2188  
Telex: 93859  
Cable: HEWPARD Perth  
A,CH,CM,E,MS,P

### Sydney, New South Wales Office

Hewlett-Packard Australia Ltd.  
17-23 Talavera Road  
P.O. Box 308  
NORTH RYDE, N.S.W. 2113  
Tel: 887-1611  
Telex: 21561  
Cable: HEWPARD Sydney  
A,CH,CM,CS,E,MS,P

### AUSTRIA

Hewlett-Packard Ges.m.b.h.  
Grottenhofstrasse 94  
A-8052 GRAZ  
Tel: (0316) 291 5 66  
Telex: 32375  
CH,E  
Hewlett-Packard Ges.m.b.h.  
Liebigasse 1  
P.O. Box 72  
A-1222 VIENNA  
Tel: (0222) 23 65 11-0  
Telex: 134425 HEPA A  
A,CH,CM,CS,E,MS,P

### BAHRAIN

*Green Salon*  
P.O. Box 557  
Manama  
BAHRAIN  
Tel: 255503-255950  
Telex: 844 19  
P

*Wael Pharmacy*

P.O. Box 648

### BAHRAIN

*Telex: 256123*  
Telex: 8550 WAEL BN  
E,C,M

### BELGIUM

Hewlett-Packard Belgium S.A./N.V.  
Blvd de la Woluwe, 100  
Woluwedal  
B-1200 BRUSSELS  
Tel: (02) 762-32-00  
Telex: 23-494 paloben bru  
A,CH,CM,CS,E,MP,P

### BRAZIL

Hewlett-Packard do Brasil I.e.C. Ltda.  
Alameda Rio Negro, 750  
Alphaville  
06400 BARUERI SP  
Tel: (011) 421.1311  
Telex: (011) 33872 HPBR-BR  
Cable: HEWPACK Sao Paulo  
A,CH,CM,CS,E,M,P  
Hewlett-Packard do Brasil I.e.C. Ltda.  
Avenida Epitacio Pessoa, 4664  
22471 RIO DE JANEIRO-RJ  
Tel: (021) 286.0237  
Telex: 021-21905 HPBR-BR  
Cable: HEWPACK Rio de Janeiro  
A,CH,CM,E,MS,P\*  
*ANAMED I.C.E.I. Ltda.*  
Rua Bage, 103  
04012 SAO PAULO  
Tel: (011) 570-5726  
Telex: 021-21905 HPBR-BR  
M



# SALES & SUPPORT OFFICES

Arranged alphabetically by country

## CANADA

### Alberta

Hewlett-Packard (Canada) Ltd.  
3030 3rd Avenue N.E.  
CALGARY, Alberta T2A 6T7  
Tel: (403) 235-3100  
A,CH,CM,E\*,MS,P\*

Hewlett-Packard (Canada) Ltd.  
11120A-178th Street  
EDMONTON, Alberta T5S 1P2  
Tel: (403) 486-6666  
A,CH,CM,CS,E,MS,P

### British Columbia

Hewlett-Packard (Canada) Ltd.  
10691 Shellbridge Way  
RICHMOND,  
British Columbia V6X 2W7  
Tel: (604) 270-2277  
Telex: 610-922-5059  
A,CH,CM,CS,E\*,MS,P\*

### Manitoba

Hewlett-Packard (Canada) Ltd.  
380-550 Century Street  
WINNIPEG, Manitoba R3H 0Y1  
Tel: (204) 786-6701  
A,CH,CM,E,MS,P\*

### Nova Scotia

Hewlett-Packard (Canada) Ltd.  
P.O. Box 931  
900 Windmill Road  
DARTMOUTH, Nova Scotia B2Y 3Z6  
Tel: (902) 469-7820  
CH,CM,CS,E\*,MS,P\*

### Ontario

Hewlett-Packard (Canada) Ltd.  
3325 N. Service Rd., Unit 6  
BURLINGTON, Ontario P3A 2A3  
Tel: (416) 335-8644  
CS,M\*

Hewlett-Packard (Canada) Ltd.  
552 Newbold Street  
LONDON, Ontario N6E 2S5  
Tel: (519) 686-9181  
A,CH,CM,E\*,MS,P\*

Hewlett-Packard (Canada) Ltd.  
6877 Goreway Drive  
MISSISSAUGA, Ontario L4V 1M8  
Tel: (416) 678-9430  
A,CH,CM,CS,E,MP,P

Hewlett-Packard (Canada) Ltd.  
2670 Queensview Dr.  
OTTAWA, Ontario K2B 8K1  
Tel: (613) 820-6483  
A,CH,CM,CS,E\*,MS,P\*

Hewlett-Packard (Canada) Ltd.  
220 Yorkland Blvd., Unit #11  
WILLOWDALE, Ontario M2J 1R5  
Tel: (416) 499-9333  
CH

### Quebec

Hewlett-Packard (Canada) Ltd.  
17500 South Service Road  
Trans-Canada Highway  
KIRKLAND, Quebec H9J 2M5  
Tel: (514) 697-4232  
A,CH,CM,CS,E,MP,P\*

Hewlett-Packard (Canada) Ltd.  
Les Galeries du Vallon  
2323 Du Versant Nord  
STE. FOY, Quebec G1N 4C2  
Tel: (418) 687-4570  
CH

## CHILE

Jorge Calcagni y Cia. Ltda.  
Av. Italia 634 Santiago  
Casilla 16475  
SANTIAGO 9  
Tel: 222-0222  
Telex: Public Booth 440001  
A,CM,E,M

Olympia (Chile) Ltda.  
Av. Rodrigo de Araya 1045  
Casilla 256-V  
SANTIAGO 21  
Tel: (02) 22 55 044  
Telex: 240-565 OLYMP CL  
Cable: Olympiachile Santiagochile  
CH,CS,P

## CHINA, People's Republic of

China Hewlett-Packard Rep. Office  
P.O. Box 418  
1A Lane 2, Luchang St.  
Beiwei Rd., Xuanwu District  
BEIJING  
Tel: 33-1947, 33-7426  
Telex: 22601 CTSHP CN  
Cable: 1920  
A,CH,CM,CS,E,P

## COLOMBIA

Instrumentación  
H. A. Langebaek & Kier S.A.  
Carrera 4A No. 52A-26  
Apartado Aereo 6287  
BOGOTA 1, D.E.  
Tel: 212-1466  
Telex: 44400 INST CO  
Cable: AARIS Bogota  
CM,E,M

Casa Humboldt Ltda.  
Carrera 14, No. 98-60  
Apartado Aereo 51283  
BOGOTA 1, D.E.  
Tel: 256-1686  
Telex: 45403 CCAL CO.  
A

## COSTA RICA

Cientifica Costarricense S.A.  
Avenida 2, Calle 5  
San Pedro de Montes de Oca  
Apartado, 10159  
SAN JOSE  
Tel: 24-38-20, 24-08-19  
Telex: 2367 GALGUR CR  
CM,E,M

## CYPRUS

Telexa Ltd.  
P.O. Box 4809  
14C Stassinou Avenue  
NICOSIA  
Tel: 62698  
Telex: 2894 LEVIDO CY  
E,M,P

## DENMARK

Hewlett-Packard A/S  
Datavej 52  
DK-3460 BIRKEROD  
Tel: (02) 81-66-40  
Telex: 37409 hpas dk  
A,CH,CM,CS,E,MS,P

Hewlett-Packard A/S  
Røllighedsvej 32  
DK-8240 RISSKOV, Aarhus  
Tel: (06) 17-60-00  
Telex: 37409 hpas dk  
CH,E

## DOMINICAN REPUBLIC

Microprog S.A.  
Juan Tomás Mejía y Cotes No. 60  
Arroyo Hondo  
SANTO DOMINGO  
Tel: 565-6268  
Telex: 4510 ARENTA DR (RCA) P

## ECUADOR

CYEDE Cia. Ltda.  
Avenida Eloy Alfaro 1749  
Casilla 6423 CCI  
QUITO  
Tel: 450-975, 243-052  
Telex: 2548 CYEDE ED  
CM,E,P

Hospitalar S.A.  
Robles 625  
Casilla 3590  
QUITO  
Tel: 545-250, 545-122  
Telex: 2485 HOSPTL ED  
Cable: HOSPITALAR-Quito  
M

## EGYPT

International Engineering Associates  
24 Hussein Hegazi Street  
Kasr-el-Aini  
CAIRO  
Tel: 23829, 21641  
Telex: IEA UN 93830  
CH,CS,E,M

EGYPOR  
P.O.Box 2558  
42 El Zahraa Street  
CAIRO, Egypt  
Tel: 65 00 21  
Telex: 93 337  
P

## EL SALVADOR

IPESA de El Salvador S.A.  
29 Avenida Norte 1216  
SAN SALVADOR  
Tel: 26-6858, 26-6868  
Telex: 20539 IPESASAL  
A,CH,CM,CS,E,P

## FINLAND

Hewlett-Packard Oy  
Revontulentie 7  
PL 24  
SF-02101 ESPOO 10  
Tel: (90) 4550211  
Telex: 121563 hewpa sf  
CH,CM,CS,P

Hewlett-Packard Oy  
(Olarinluoma 7)  
PL 24  
02101 ESPOO 10  
Tel: (90) 4521022  
A,E,MS

Hewlett-Packard Oy  
Aatoksenkatv 10-C  
SF-40720-72 JYVASKYLA  
Tel: (941) 216318  
CH

Hewlett-Packard Oy  
Kainuntie 1-C  
SF-90140-14 OULU  
Tel: (981) 338785  
CH

## FRANCE

Hewlett-Packard France  
Z.I. Mercure B  
Rue Berthelot  
F-13763 Les Milles Cedex  
AIX-EN-PROVENCE  
Tel: 16 (42) 59-41-02  
Telex: 410770F  
A,CH,E,MS,P\*

Hewlett-Packard France  
64, rue Marchand Saillant  
F-61000 ALENCON  
Tel: 16 (33) 29 04 42

Hewlett-Packard France  
Boite Postale 503  
F-25026 BESANCON  
28 rue de la Republique  
F-25000 BESANCON  
Tel: 16 (81) 83-16-22  
CH,M

Hewlett-Packard France  
13, Place Napoleon III  
F-29000 BREST  
Tel: 16 (98) 03-38-35

Hewlett-Packard France  
Chemin des Mouilles  
Boite Postale 162  
F-69130 ECULLY Cedex (Lyon)  
Tel: 16 (78) 833-81-25  
Telex: 310617F  
A,CH,CS,E,MP

Hewlett-Packard France  
Tour Lorraine  
Boulevard de France  
F-91035 EVRY Cedex  
Tel: 16 6 077-96-60  
Telex: 692315F  
E

Hewlett-Packard France  
Parc d'Activite du Bois Briard  
Ave. du Lac  
F-91040 EVRY Cedex  
Tel: 16 6 077-8383  
Telex: 692315F  
E

Hewlett-Packard France  
5, avenue Raymond Chanas  
F-38320 EYBENS (Grenoble)  
Tel: 16 (76) 25-81-41  
Telex: 980124 HP GRENOB EYBE  
CH

Hewlett-Packard France  
Centre d'Affaire Paris-Nord  
Bâtiment Ampère 5 étage  
Rue de la Commune de Paris  
Boite Postale 300  
F-93153 LE BLANC MESNIL  
Tel: 16 (1) 865-44-52  
Telex: 211032F  
CH,CS,E,MS

Hewlett-Packard France  
Parc d'Activités Cadera  
Quartier Jean Mermoz  
Avenue du Président JF Kennedy  
F-33700 MERIGNAC (Bordeaux)  
Tel: 16 (56) 34-00-84  
Telex: 550105F  
CH,E,MS

Hewlett-Packard France  
Immeuble "Les 3 B"  
Nouveau Chemin de la Garde  
ZAC de Bois Briard  
F-44085 NANTES Cedex  
Tel: 16 (40) 50-32-22  
CH\*\*

# SALES & SUPPORT OFFICES

Arranged alphabetically by country

3



## FRANCE (Cont'd)

Hewlett-Packard France  
125, rue du Faubourg Bannier  
F-45000 ORLEANS  
Tel: 16 (38) 68 01 63

Hewlett-Packard France  
Zone Industrielle de Courtaboeuf  
Avenue des Tropiques  
F-91947 Les Ulis Cedex ORSAY  
Tel: (6) 907-78-25  
Telex: 600048F  
A,CH,CM,CS,E,MP,P

Hewlett-Packard France  
Paris Porte-Maillot  
15, Avenue de L'Amiral Bruix  
F-75782 PARIS CEDEX 16  
Tel: 16 (1) 502-12-20  
Telex: 613663F  
CH,MS,P

Hewlett-Packard France  
124, Boulevard Tourasse  
F-64000 PAU  
Tel: 16 (59) 80 38 02

Hewlett-Packard France  
2 Allée de la Bourgonnette  
F-35100 RENNES  
Tel: 16 (99) 51-42-44  
Telex: 740912F  
CH,CM,E,MS,P\*

Hewlett-Packard France  
98 Avenue de Bretagne  
F-76100 ROUEN  
Tel: 16 (35) 63-57-66  
CH\*\* ,CS

Hewlett-Packard France  
4 Rue Thomas Mann  
Boite Postale 56  
F-67033 STRASBOURG Cedex  
Tel: 16 (88) 28-56-46  
Telex: 890141F  
CH,E,MS,P\*

Hewlett-Packard France  
Le Péripole  
20, Chemin du Pigeonnier de la  
Cépière  
F-31083 TOULOUSE Cedex  
Tel: 16 (61) 40-11-12  
Telex: 531639F  
A,CH,CS,E,P\*

Hewlett-Packard France  
9, rue Baudin  
F-26000 VALENCE  
Tel: 16 (75) 42 76 16

Hewlett-Packard France  
Carolor  
ZAC de Bois Briand  
F-57640 VIGY (Metz)  
Tel: 16 (8) 771 20 22  
CH

Hewlett-Packard France  
Immeuble Péricentre  
F-59658 VILLENEUVE D'ASCQ Cedex  
Tel: 16 (20) 91-41-25  
Telex: 160124F  
CH,E,MS,P\*

**GERMAN FEDERAL  
REPUBLIC**  
Hewlett-Packard GmbH  
Geschäftsstelle  
Keithstrasse 2-4  
D-1000 BERLIN 30  
Tel: (030) 24-90-86  
Telex: 018 3405 hpbln d  
A,CH,E,M,P

Hewlett-Packard GmbH  
Geschäftsstelle  
Herrenberger Strasse 130  
D-7030 BOBLINGEN  
Tel: (7031) 14-0  
Telex:  
A,CH,CM,CS,E,MP,P

Hewlett-Packard GmbH  
Geschäftsstelle  
Emanuel-Leutze-Strasse 1  
D-4000 DUSSELDORF  
Tel: (0211) 5971-1  
Telex: 085/86 533 hpdd d  
A,CH,CS,E,MS,P

Hewlett-Packard GmbH  
Geschäftsstelle  
Schleefstr. 28a  
D-4600 DORTMUND-Aplerbeck  
Tel: (0231) 45001

Hewlett-Packard GmbH  
Vertriebszentrale Frankfurt  
Bernner Strasse 117  
Postfach 560 140  
D-6000 FRANKFURT 56  
Tel: (0611) 50-04-1  
Telex: 04 13249 hpffm d  
A,CH,CM,CS,E,MP,P

Hewlett-Packard GmbH  
Geschäftsstelle  
Aussenstelle Bad Homburg  
Louisenstrasse 115  
D-6380 BAD HOMBURG  
Tel: (06172) 109-0

Hewlett-Packard GmbH  
Geschäftsstelle  
Kapstadtring 5  
D-2000 HAMBURG 60  
Tel: (040) 63804-1  
Telex: 021 63 032 hphd d  
A,CH,CS,E,MS,P

Hewlett-Packard GmbH  
Geschäftsstelle  
Heidering 37-39  
D-3000 HANNOVER 61  
Tel: (0511) 5706-0  
Telex: 092 3259  
A,CH,CM,E,MS,P

Hewlett-Packard GmbH  
Geschäftsstelle  
Rosslauer Weg 2-4  
D-6800 MANNHEIM  
Tel: (0621) 70050  
Telex: 0462105  
A,C,E

Hewlett-Packard GmbH  
Geschäftsstelle  
Messerschmittstrasse 7  
D-7910 NEU ULM  
Tel: 0731-70241  
Telex: 0712816 HP ULM-D  
A,C,E\*

Hewlett-Packard GmbH  
Geschäftsstelle  
Ehlicherstr. 13  
D-8500 NÜRNBERG 10  
Tel: (0911) 5205-0  
Telex: 0623 860  
CH,CM,E,MS,P

Hewlett-Packard GmbH  
Geschäftsstelle  
Eschenstrasse 5  
D-8028 TAUFKIRCHEN  
Tel: (089) 6117-1  
Telex: 0524985  
A,CH,CM,E,MS,P

## GREAT BRITAIN

See United Kingdom

## GREECE

Kostas Karayannis S.A.  
8 Omirou Street  
ATHENS 133  
Tel: 32 30 303, 32 37 371  
Telex: 215962 RKAR GR  
A,CH,CM,CS,E,M,P

PLAISIO S.A.  
G. Gerardos  
24 Stournara Street  
ATHENS  
Tel: 36-11-160  
Telex: 221871  
P

## GUATEMALA

IPESA  
Avenida Reforma 3-48, Zona 9  
GUATEMALA CITY  
Tel: 316627, 314786  
Telex: 4192 TELTRO GU  
A,CH,CM,CS,E,M,P

## HONG KONG

Hewlett-Packard Hong Kong, Ltd.  
G.P.O. Box 795  
5th Floor, Sun Hung Kai Centre  
30 Harbour Road  
HONG KONG  
Tel: 5-8323211  
Telex: 66678 HEWPA HX  
Cable: HEWPACK HONG KONG  
E,CH,CS,P

CET Ltd.  
1402 Tung Wah Mansion  
199-203 Hennessy Rd.  
Wanchia, HONG KONG  
Tel: 5-729376  
Telex: 85148 CET HX  
CM

Schmidt & Co. (Hong Kong) Ltd.  
Wing On Centre, 28th Floor  
Connaught Road, C.  
HONG KONG  
Tel: 5-455644  
Telex: 74766 SCHMX HX  
A,M

## ICELAND

Elding Trading Company Inc.  
Hafnarnvoli-Tryggvagotu  
P.O. Box 895  
IS-REYKJAVIK  
Tel: 1-58-20, 1-63-03  
M

## INDIA

Computer products are sold through  
Blue Star Ltd. All computer repairs and  
maintenance service is done through  
Computer Maintenance Corp.

Blue Star Ltd.  
Sabri Complex II Floor  
24 Residency Rd.  
BANGALORE 560 025  
Tel: 55660  
Telex: 0845-430  
Cable: BLUESTAR  
A,CH\*,CM,CS\*,E

Blue Star Ltd.  
Band Box House  
Prabhadevi  
BOMBAY 400 025  
Tel: 422-3101  
Telex: 011-3751  
Cable: BLUESTAR  
A,M

Blue Star Ltd.  
Sahas  
414/2 Vir Savarkar Marg  
Prabhadevi  
BOMBAY 400 025  
Tel: 422-6155  
Telex: 011-4093  
Cable: FROSTBLUE  
A,CH\*,CM,CS\*,E,M

Blue Star Ltd.  
Kalyan, 19 Vishwas Colony  
Alkapuri, BORODA, 390 005  
Tel: 65235  
Cable: BLUE STAR  
A

Blue Star Ltd.  
7 Hare Street  
CALCUTTA 700 001  
Tel: 12-01-31  
Telex: 021-7655  
Cable: BLUESTAR  
A,M

Blue Star Ltd.  
133 Kodambakkam High Road  
MADRAS 600 034  
Tel: 82057  
Telex: 041-379  
Cable: BLUESTAR  
A,M

Blue Star Ltd.  
Bhandari House, 7th/8th Floors  
91 Nehru Place  
NEW DELHI 110 024  
Tel: 682547  
Telex: 031-2463  
Cable: BLUESTAR  
A,CH\*,CM,CS\*,E,M

Blue Star Ltd.  
15/16-C Wellesley Rd.  
PUNE 411 011  
Tel: 22775  
Cable: BLUE STAR  
A

Blue Star Ltd.  
2-2-47/1108 Bolarum Rd.  
SECUNDERABAD 500 003  
Tel: 72057  
Telex: 0155-459  
Cable: BLUEFROST  
A,E

Blue Star Ltd.  
T.C. 7/603 Poornima  
Maruthankuzhi  
TRIVANDRUM 695 013  
Tel: 65799  
Telex: 0884-259  
Cable: BLUESTAR  
E

Computer Maintenance Corporation  
Ltd.  
115, Sarojini Devi Road  
SECUNDERABAD 500 003  
Tel: 310-184, 345-774  
Telex: 031-2960  
CH\*\*



# SALES & SUPPORT OFFICES

Arranged alphabetically by country

## INDONESIA

**BERCA Indonesia P.T.**  
P.O.Box 496/Jkt.  
Jl. Abdul Muis 62  
**JAKARTA**  
Tel: 21-373009  
Telex: 46748 BERSAL IA  
Cable: BERSAL JAKARTA P

**BERCA Indonesia P.T.**  
P.O.Box 2497/Jkt  
Antara Bldg., 17th Floor  
Jl. Medan Merdeka Selatan 17  
**JAKARTA-PUSAT**  
Tel: 21-344-181  
Telex: BERSAL IA  
A,CS,E,M

**BERCA Indonesia P.T.**  
P.O. Box 174/SBY.  
Jl. Kutei No. 11  
**SURABAYA**  
Tel: 68172  
Telex: 31146 BERSAL SB  
Cable: BERSAL-SURABAYA  
A\*,E,M,P

## IRAQ

Hewlett-Packard Trading S.A.  
Service Operation  
Al Mansoor City 9B/3/7  
**BAGHDAD**  
Tel: 551-49-73  
Telex: 212-455 HEPAIRAQ IK  
CH,CS

## IRELAND

Hewlett-Packard Ireland Ltd.  
82/83 Lower Leeson Street  
**DUBLIN 2**  
Tel: 0001 608800  
Telex: 30439  
A,CH,CM,CS,E,M,P

**Cardiac Services Ltd.**  
Kilmore Road  
Artane  
**DUBLIN 5**  
Tel: (01) 35 1820  
Telex: 30439  
M

## ISRAEL

**Eidan Electronic Instrument Ltd.**  
P.O.Box 1270  
**JERUSALEM 91000**  
16, Ohaliav St.  
**JERUSALEM 94467**  
Tel: 533 221, 553 242  
Telex: 25231 AB/PAKRD IL  
A

**Electronics Engineering Division**  
**Motorola Israel Ltd.**  
16 Kremenetski Street  
P.O. Box 25016  
**TEL-AVIV 67899**  
Tel: 3 88 388  
Telex: 33569 Motil IL  
Cable: BASTEL Tel-Aviv  
CH,CM,CS,E,M,P

## ITALY

Hewlett-Packard Italiana S.p.A.  
Traversa 99C  
Via Giulio Petroni, 19  
I-70124 **BARI**  
Tel: (080) 41-07-44  
M

Hewlett-Packard Italiana S.p.A.  
Via Martin Luther King, 38/III  
I-40132 **BOLOGNA**  
Tel: (051) 402394  
Telex: 511630  
CH,E,MS

Hewlett-Packard Italiana S.p.A.  
Via Principe Nicola 43G/C  
I-95126 **CATANIA**  
Tel: (095) 37-10-87  
Telex: 970291  
C,P

Hewlett-Packard Italiana S.p.A.  
Via G. Di Vittorio 9  
I-20063 **CERNUSCO SUL NAVIGLIO**  
(Milano)  
Tel: (02) 923691  
Telex: 334632  
A,CH,CM,CS,E,MP,P

Hewlett-Packard Italiana S.p.A.  
Via C. Colombo 49  
I-20090 **TREZZANO SUL NAVIGLIO**  
(Milano)  
Tel: (02) 4459041  
Telex: 322116  
C,M

Hewlett-Packard Italiana S.p.A.  
Via Nuova San Rocco a  
Capodimonte, 62/A  
I-80131 **NAPOLI**  
Tel: (081) 7413544  
Telex: 710698  
A,CH,E

Hewlett-Packard Italiana S.p.A.  
Viale G. Modugno 33  
I-16156 **GENOVA PEGLI**  
Tel: (010) 68-37-07  
Telex: 215238  
E,C

Hewlett-Packard Italiana S.p.A.  
Via Pelizzo 15  
I-35128 **PADOVA**  
Tel: (049) 664888  
Telex: 430315  
A,CH,E,MS

Hewlett-Packard Italiana S.p.A.  
Viale C. Pavese 340  
I-00144 **ROMA EUR**  
Tel: (06) 54831  
Telex: 610514  
A,CH,CM,CS,E,MS,P\*

Hewlett-Packard Italiana S.p.A.  
Via di Casellina 57/C  
I-50018 **SCANDICCI-FIRENZE**  
Tel: (055) 753863

Hewlett-Packard Italiana S.p.A.  
Corso Svizzera, 185  
I-10144 **TORINO**  
Tel: (011) 74 4044  
Telex: 221079  
CH,E

## JAPAN

Yokogawa-Hewlett-Packard Ltd.  
152-1, Onna  
**ATSUGI**, Kanagawa, 243  
Tel: (0462) 28-0451  
CM,C\*,E

Yokogawa-Hewlett-Packard Ltd.  
Meiji-Seimei Bldg. 6F  
3-1 Hon Chiba-Cho  
**CHIBA**, 280  
Tel: 472 25 7701  
E,CH,CS

Yokogawa-Hewlett-Packard Ltd.  
Yasuda-Seimei Hiroshima Bldg.  
6-11, Hon-dori, Naka-ku  
**HIROSHIMA**, 730  
Tel: 82-241-0611

Yokogawa-Hewlett-Packard Ltd.  
Towa Building  
2-3, Kaigan-dori, 2 Chome Chuo-ku  
**KOBE**, 650  
Tel: (078) 392-4791  
C,E

Yokogawa-Hewlett-Packard Ltd.  
Kumagaya Asahi 82 Bldg  
3-4 Tsukuba  
**KUMAGAYA**, Saitama 360  
Tel: (0485) 24-6563  
CH,CM,E

Yokogawa-Hewlett-Packard Ltd.  
Asahi Shinbun Daiichi Seimei Bldg.  
4-7, Hanabata-cho  
**KUMAMOTO**, 860  
Tel: (0963) 54-7311  
CH,E

Yokogawa-Hewlett-Packard Ltd.  
Shin-Kyoto Center Bldg.  
614, Higashi-Shiokoji-cho  
Karasuma-Nishiiru  
Shiokoji-dori, Shimogyo-ku  
**KYOTO**, 600  
Tel: 075-343-0921  
CH,E

Yokogawa-Hewlett-Packard Ltd.  
Mito Mitsui Bldg  
4-73, Sanno-maru, 1 Chome  
**MITO**, Ibaraki 310  
Tel: (0292) 25-7470  
CH,CM,E

Yokogawa-Hewlett-Packard Ltd.  
Sumitomo Seimei 14-9 Bldg.  
Meieki-Minami, 2 Chome  
Nakamura-ku  
**NAGOYA**, 450  
Tel: (052) 571-5171  
CH,CM,CS,E,MS

Yokogawa-Hewlett-Packard Ltd.  
Chuo Bldg.,  
4-20 Nishinakajima, 5 Chome  
Yodogawa-ku  
**OSAKA**, 532  
Tel: (06) 304-6021  
Telex: YHPOSA 523-3624  
A,CH,CM,CS,E,MP,P\*

Yokogawa-Hewlett-Packard Ltd.  
27-15, Yabe, 1 Chome  
**SAGAMIHARA** Kanagawa, 229  
Tel: 0427 59-1311

Yokogawa-Hewlett-Packard Ltd.  
Daiichi Seimei Bldg.  
7-1, Nishi Shinjuku, 2 Chome  
Shinjuku-ku, **TOKYO** 160  
Tel: 03-348-4611  
CH,E

Yokogawa-Hewlett-Packard Ltd.  
29-21 Takaido-Higashi, 3 Chome  
Suginami-ku **TOKYO** 168  
Tel: (03) 331-6111  
Telex: 232-2024 YHPTOK  
A,CH,CM,CS,E,MP,P\*

Yokogawa-Hewlett-Packard Ltd.  
Daiichi Asano Building  
2-8, Odori, 5 Chome  
**UTSUNOMIYA**, Tochigi 320  
Tel: (0286) 25-7155  
CH,CS,E

Yokogawa-Hewlett-Packard Ltd.  
Yasuda Seimei Nishiguchi Bldg.  
30-4 Tsuruya-cho, 3 Chome  
**YOKOHAMA** 221  
Tel: (045) 312-1252  
CH,CM,E

## JORDAN

**Mouasher Cousins Company**  
P.O. Box 1387  
**AMMAN**  
Tel: 24907, 39907  
Telex: 21456 SABCO JO  
CH,E,M,P

## KENYA

**ADCOM Ltd., Inc., Kenya**  
P.O.Box 30070  
**NAIROBI**  
Tel: 331955  
Telex: 22639  
E,M

## KOREA

**Samsung Electronics HP Division**  
12 Fl. Kinam Bldg.  
San 75-31, Yeoksam-Dong  
Kangnam-Ku  
Yeongdong P.O. Box 72  
**SEOUL**  
Tel: 555-7555, 555-5447  
Telex: K27364 SAMSAN  
A,CH,CM,CS,E,M,P

## KUWAIT

**Al-Khaldiya Trading & Contracting**  
P.O. Box 830 Safat  
**KUWAIT**  
Tel: 42-4910, 41-1726  
Telex: 22481 Areeg kl  
CH,E,M

**Photo & Cine Equipment**  
P.O. Box 270 Safat  
**KUWAIT**  
Tel: 42-2846, 42-3801  
Telex: 22247 Matin kl  
P

## LEBANON

**G.M. Dolmadjian**  
Achrafieh  
P.O. Box 165.167  
**BEIRUT**  
Tel: 290293  
MP\*\*

**Computer Information Systems**  
P.O. Box 11-6274  
**BEIRUT**  
Tel: 89 40 73  
Telex: 22259  
C

## LUXEMBOURG

Hewlett-Packard Belgium S.A./N.V.  
Blvd de la Woluwe, 100  
Woluwedal  
B-1200 **BRUSSELS**  
Tel: (02) 762-32-00  
Telex: 23-494 paloben bru  
A,CH,CM,CS,E,MP,P

## MALAYSIA

Hewlett-Packard Sales (Malaysia)  
Sdn. Bhd.  
1st Floor, Bangunan British  
American  
Jalan Semantan, Damansara Heights  
**KUALA LUMPUR** 23-03  
Tel: 943022  
Telex: MA31011  
A,CH,E,M,P\*





## MAYLAISIA (Cont'd)

Protel Engineering  
P.O. Box 1917  
Lot 6624, Section 64  
23/4 Pending Road  
Kuching, SARAWAK  
Tel: 36299  
Telex: MA 70904 PROMAL  
Cable: PROTELENG  
A,E,M

## MALTA

Philip Toledo Ltd.  
Notabile Rd.  
MRIEHEL  
Tel: 447 47, 455 66  
Telex: Media MW 649  
E,P

## MEXICO

Hewlett-Packard Mexicana, S.A.  
de C.V.  
Av. Periferico Sur No. 6501  
Tepepan, Xochimilco  
16020 MEXICO D.F.  
Tel: 6-76-46-00  
Telex: 17-74-507 HEWPACK MEX  
A,CH,CS,E,MS,P

Hewlett-Packard Mexicana, S.A.  
de C.V.  
Ave. Colonia del Valle 409  
Col. del Valle  
Municipio de Garza Garcia  
MONTERREY, Nuevo Leon  
Tel: 78 42 41  
Telex: 038 410  
CH

ECISA  
José Vasconcelos No. 218  
Col. Condesa Deleg. Cuauhtémoc  
MEXICO D.F. 06140  
Tel: 553-1206  
Telex: 17-72755 ECE ME  
M

## MOROCCO

Dolbeau  
81 rue Karachi  
CASABLANCA  
Tel: 3041-82, 3068-38  
Telex: 23051, 22822  
E

Gerep  
2 rue d'Agadir  
Boite Postale 156  
CASABLANCA  
Tel: 272093, 272095  
Telex: 23 739  
P

## NETHERLANDS

Hewlett-Packard Nederland B.V.  
Van Heuven Goedhartlaan 121  
NL 1181KK AMSTELVEEN  
P.O. Box 667  
NL 1180 AR AMSTELVEEN  
Tel: (020) 47-20-21  
Telex: 13 216 HEPAN NL  
A,CH,CM,CS,E,MP,P  
Hewlett-Packard Nederland B.V.  
Bongerd 2  
NL 2906VK CAPELLE A/D IJSSEL  
P.O. Box 41  
NL 2900AA CAPELLE A/D IJSSEL  
Tel: (10) 51-64-44  
Telex: 21261 HEPAC NL  
A,CH,CS,E

Hewlett-Packard Nederland B.V.  
Pastoor Petersstraat 134-136  
NL 5612 LV EINDHOVEN  
P.O. Box 2342  
NL 5600 CH EINDHOVEN  
Tel: (040) 326911  
Telex: 51484 hepae nl  
A,CH\*,\*,E,M

## NEW ZEALAND

Hewlett-Packard (N.Z.) Ltd.  
5 Owens Road  
P.O. Box 26-189  
Epsom, AUCKLAND  
Tel: 687-159  
Cable: HEWPACK Auckland  
CH,CM,E,P\*  
Hewlett-Packard (N.Z.) Ltd.  
4-12 Cruickshank Street  
Kilbirnie, WELLINGTON 3  
P.O. Box 9443  
Courtenay Place, WELLINGTON 3  
Tel: 877-199  
Cable: HEWPACK Wellington  
CH,CM,E,P  
Northrop Instruments & Systems Ltd.  
369 Khyber Pass Road  
P.O. Box 8602  
AUCKLAND  
Tel: 794-091  
Telex: 60605  
A,M

Northrop Instruments & Systems Ltd.  
110 Mandeville St.  
P.O. Box 8388  
CHRISTCHURCH  
Tel: 486-928  
Telex: 4203  
A,M  
Northrop Instruments & Systems Ltd.  
Sturdee House  
85-87 Ghuznee Street  
P.O. Box 2406  
WELLINGTON  
Tel: 850-091  
Telex: NZ 3380  
A,M

## NORTHERN IRELAND

See United Kingdom

## NORWAY

Hewlett-Packard Norge A/S  
Folke Bernadottes vei 50  
P.O. Box 3558  
N-5033 FYLLINGSDALEN (Bergen)  
Tel: 0047/5/16 55 40  
Telex: 16621 hpnas n  
CH,CS,E,MS  
Hewlett-Packard Norge A/S  
Østerdalen 16-18  
P.O. Box 34  
N-1345 ØSTERÅS  
Tel: 0047/2/17 11 80  
Telex: 16621 hpnas n  
A,CH,CM,CS,E,M,P

## OMAN

Khimjil Ramdas  
P.O. Box 19  
MUSCAT  
Tel: 722225, 745601  
Telex: 3289 BROKER MB MUSCAT  
P  
Suhail & Saud Bahwan  
P.O. Box 169  
MUSCAT  
Tel: 734 201-3  
Telex: 3274 BAHWAN MB

## PAKISTAN

Mushko & Company Ltd.  
1-B, Street 43  
Sector F-8/1  
ISLAMABAD  
Tel: 51071  
Cable: FEMUS Rawalpindi  
A,E,M  
Mushko & Company Ltd.  
Oosman Chambers  
Abdullah Haroon Road  
KARACHI 0302  
Tel: 524 131, 524 132  
Telex: 2894 MUSKO PK  
Cable: COOPERATOR Karachi  
A,E,M,P\*

## PANAMA

Electrónico Balboa, S.A.  
Calle Samuel Lewis, Ed. Alfa  
Apartado 4929  
PANAMA 5  
Tel: 63-6613, 63-6748  
Telex: 3483 ELECTRON PG  
A,CM,E,M,P

## PERU

Cía Electro Médica S.A.  
Los Flamencos 145, San Isidro  
Casilla 1030  
LIMA 1  
Tel: 41-4325, 41-3703  
Telex: Pub. Booth 25306  
CM,E,M,P

## PHILIPPINES

The Online Advanced Systems  
Corporation  
Rico House, Amorsolo Cor. Herrera  
Street  
Legaspi Village, Makati  
P.O. Box 1510  
Metro MANILA  
Tel: 85-35-81, 85-34-91, 85-32-21  
Telex: 3274 ONLINE  
A,CH,CS,E,M  
Electronic Specialists and Proponents  
Inc.  
690-B Epitanio de los Santos Avenue  
Cubao, QUEZON CITY  
P.O. Box 2649 Manila  
Tel: 98-96-81, 98-96-82, 98-96-83  
Telex: 40018, 42000 ITT GLOBE  
MACKAY BOOTH  
P

## PORTUGAL

Mundinter  
Intercambio Mundial de Comércio  
S.A.R.L.  
P.O. Box 2761  
Av. Antonio Augusto de Aguiar 138  
P-LISBON  
Tel: (19) 53-21-31, 53-21-37  
Telex: 16691 munter p  
M  
Soquimica  
Av. da Liberdade, 220-2  
1298 LISBOA Codex  
Tel: 56 21 81/2/3  
Telex: 13316 SABASA  
P

Telectra-Empresa Técnica de  
Equipamentos Eléctricos S.A.R.L.  
Rua Rodrigo da Fonseca 103  
P.O. Box 2531  
P-LISBON 1  
Tel: (19) 68-60-72  
Telex: 12598  
CH,CS,E,P

## PUERTO RICO

Hewlett-Packard Puerto Rico  
Ave. Muñoz Rivera #101  
Esq. Calle Ochoa  
HATO REY, Puerto Rico 00918  
Tel: (809) 754-7800  
Hewlett-Packard Puerto Rico  
Calle 272 Edificio 203  
Urb. Country Club  
RIO PIEDRAS, Puerto Rico  
P.O. Box 4407  
CAROLINA, Puerto Rico 00628  
Tel: (809) 762-7255  
A,CH,CS

## QATAR

Computeabia  
P.O. Box 2750  
DOHA  
Tel: 883555  
Telex: 4806 CHPARB  
P  
Eastern Technical Services  
P.O. Box 4747  
DOHA  
Tel: 329 993  
Telex: 4156 EASTEC DH  
Nasser Trading & Contracting  
P.O. Box 1563  
DOHA  
Tel: 22170, 23539  
Telex: 4439 NASSER DH  
M

## SAUDI ARABIA

Modern Electronic Establishment  
Hewlett-Packard Division  
P.O. Box 22015  
Thuobah  
AL-KHOBAR  
Tel: 895-1760, 895-1764  
Telex: 671 106 HPMEEK SJ  
Cable: ELECTA AL-KHOBAR  
CH,CS,E,M  
Modern Electronic Establishment  
Hewlett-Packard Division  
P.O. Box 22015  
Redec Plaza, 6th Floor  
JEDDAH  
Tel: 644 38 48  
Telex: 4027 12 FARNAS SJ  
Cable: ELECTA JEDDAH  
CH,CS,E,M  
Modern Electronic Establishment  
Hewlett-Packard Division  
P.O. Box 22015  
RIYADH  
Tel: 491-97 15, 491-63 87  
Telex: 202049 MEERYD SJ  
CH,CS,E,M  
Abdul Ghani El Ajou  
P.O. Box 78  
RIYADH  
Tel: 40 41 717  
Telex: 200 932 EL AJOU  
P

## SCOTLAND

See United Kingdom

## SINGAPORE

Hewlett-Packard Singapore (Sales)  
Pte. Ltd.  
#08-00 Inchcape House  
450-2 Alexandra Road  
P.O. Box 58 Alexandra Rd. Post Office  
SINGAPORE, 9115  
Tel: 631788  
Telex: HPSGSO RS 34209  
Cable: HEWPACK, Singapore  
A,CH,CS,E,MS,P



# SALES & SUPPORT OFFICES

Arranged alphabetically by country

## SINGAPORE (Cont'd)

*Dynamar International Ltd.*  
Unit 05-11 Block 6  
Kolam Ayer Industrial Estate  
**SINGAPORE 1334**  
Tel: 747-6188  
Telex: RS 26283  
CM

## SOUTH AFRICA

Hewlett-Packard So Africa (Pty.) Ltd.  
P.O. Box 120  
Howard Place **CAPE PROVINCE 7450**  
Pine Park Center, Forest Drive,  
Pinelands  
**CAPE PROVINCE 7405**  
Tel: 53-7954  
Telex: 57-20006  
A,CH,CM,E,MS,P  
Hewlett-Packard So Africa (Pty.) Ltd.  
P.O. Box 37099  
92 Overport Drive  
**DURBAN 4067**  
Tel: 28-4178, 28-4179, 28-4110  
Telex: 6-22954  
CH,CM

Hewlett-Packard So Africa (Pty.) Ltd.  
6 Linton Arcade  
511 Cape Road  
Linton Grange  
**PORT ELIZABETH 6000**  
Tel: 041-302148  
CH

Hewlett-Packard So Africa (Pty.) Ltd.  
P.O.Box 33345  
Glenstantia 0010 **TRANSVAAL**  
1st Floor East  
Constantia Park Ridge Shopping  
Centre  
Constantia Park  
**PRETORIA**  
Tel: 982043  
Telex: 32163  
CH,E

Hewlett-Packard So Africa (Pty.) Ltd.  
Private Bag Wendywood  
**SANDTON 2144**  
Tel: 802-5111, 802-5125  
Telex: 4-20877  
Cable: HEWPACK Johannesburg  
A,CH,CM,CS,E,MS,P

## SPAIN

Hewlett-Packard Española S.A.  
Calle Entenza, 321  
E-**BARCELONA 29**  
Tel: 322.24.51, 321.73.54  
Telex: 52603 hpbee  
A,CH,CS,E,MS,P

Hewlett-Packard Española S.A.  
Calle San Vicente S/No  
Edificio Albia II  
E-**BILBAO 1**  
Tel: 423.83.06  
A,CH,E,MS

Hewlett-Packard Española S.A.  
Ctra. de la Coruña, Km. 16, 400  
Las Rozas  
E-**MADRID**  
Tel: (1) 637.00.11  
CH,CS,M

Hewlett-Packard Española S.A.  
Avda. S. Francisco Javier, S/no  
Planta 10. Edificio Sevilla 2,  
E-**SEVILLA 5**  
Tel: 64.44.54  
Telex: 72933  
A,CS,MS,P

Hewlett-Packard Española S.A.  
Calle Ramon Gordillo, 1 (Entlo.3)  
E-**VALENCIA 10**  
Tel: 361-1354  
CH,P

## SWEDEN

Hewlett-Packard Sverige AB  
Sunnanvagen 14K  
S-22226 **LUND**  
Tel: (046) 13-69-79  
Telex: (854) 17886 (via Spånga  
office)  
CH

Hewlett-Packard Sverige AB  
Östra Tullgatan 3  
S-21128 **MALMÖ**  
Tel: (040) 70270  
Telex: (854) 17886 (via Spånga  
office)

Hewlett-Packard Sverige AB  
Västra Vintergatan 9  
S-70344 **ÖREBRO**  
Tel: (19) 10-48-80  
Telex: (854) 17886 (via Spånga  
office)  
CH

Hewlett-Packard Sverige AB  
Skalholtsgatan 9, Kista  
Box 19  
S-16393 **SPÅNGA**  
Tel: (08) 750-2000  
Telex: (854) 17886  
Telefax: (08) 7527781  
A,CH,CM,CS,E,MS,P

Hewlett-Packard Sverige AB  
Fröfallisgatan 30  
S-42132 **VÄSTRA-FRÖLUNDA**  
Tel: (031) 49-09-50  
Telex: (854) 17886 (via Spånga  
office)  
CH,E,P

## SWITZERLAND

Hewlett-Packard (Schweiz) AG  
Clarastrasse 12  
CH-4058 **BASEL**  
Tel: (61) 33-59-20  
A

Hewlett-Packard (Schweiz) AG  
7, rue du Bois-du-Lan  
Case Postale 365  
CH-1217 **MEYRIN 2**  
Tel: (0041) 22-83-11-11  
Telex: 27333 HPAG CH  
CH,CM,CS

Hewlett-Packard (Schweiz) AG  
Allmend 2  
CH-8967 **WIDEN**  
Tel: (0041) 57 31 21 11  
Telex: 53933 hpag ch  
Cable: HPAG CH  
A,CH,CM,CS,E,MS,P

## SYRIA

*General Electronic Inc.*  
Nuri Basha Ahnaf Ebn Kays Street  
P.O. Box 5781  
**DAMASCUS**  
Tel: 33-24-87  
Telex: 411 215  
Cable: ELECTROBOR DAMASCUS  
E

*Middle East Electronics*  
P.O.Box 2308  
Abu Rumaneh  
**DAMASCUS**  
Tel: 33 4 5 92  
Telex: 411 304  
M

## TAIWAN

Hewlett-Packard Far East Ltd.  
Kaohsiung Office  
2/F 68-2, Chung Cheng 3rd Road  
**KAOHSIUNG**  
Tel: (07) 241-2318  
CH,CS,E

Hewlett-Packard Far East Ltd.  
Taiwan Branch  
8th Floor  
337 Fu Hsing North Road  
**TAIPEI**  
Tel: (02) 712-0404  
Telex: 24439 HEWPACK  
Cable: HEWPACK Taipei  
A,CH,CM,CS,E,M,P  
*Ing Lih Trading Co.*  
3rd Floor, 7 Jen-Ai Road, Sec. 2  
**TAIPEI 100**  
Tel: (02) 3948191  
Cable: INGLIH TAIPEI  
A

## THAILAND

*Unimesa*  
30 Patpong Ave., Suriwong  
**BANGKOK 5**  
Tel: 235-5727  
Telex: 84439 Simonco TH  
Cable: UNIMESA Bangkok  
A,CH,CS,E,M  
*Bangkok Business Equipment Ltd.*  
5/5-6 Dejo Road  
**BANGKOK**  
Tel: 234-8670, 234-8671  
Telex: 87669-BEQUIPT TH  
Cable: BUSIQUIPT Bangkok  
P

## TRINIDAD & TOBAGO

*Caribbean Telecoms Ltd.*  
50/A Jerningham Avenue  
P.O. Box 732  
**PORT-OF-SPAIN**  
Tel: 62-44213, 62-44214  
Telex: 235,272 HUGCO WG  
CM,E,M,P

## TUNISIA

*Tunisie Electronique*  
31 Avenue de la Liberté  
**TUNIS**  
Tel: 280-144  
E,P

*Corema*  
1 ter. Av. de Carthage  
**TUNIS**  
Tel: 253-821  
Telex: 12319 CABAM TN  
M

## TURKEY

*Teknim Company Ltd.*  
Iran Caddesi No. 7  
Kavaklidere, **ANKARA**  
Tel: 275800  
Telex: 42155 TKNM TR  
E

*E.M.A.*  
Medina Eldem Sokak No.41/6  
Yüksel Caddesi  
**ANKARA**  
Tel: 175 622  
Telex: 42 591  
M

## UNITED ARAB EMIRATES

*Emitac Ltd.*  
P.O. Box 2711  
**ABU DHABI**  
Tel: 82 04 19-20  
Cable: EMITAC ABUDHABI  
*Emitac Ltd.*  
P.O. Box 1641  
**SHARJAH**  
Tel: 591 181  
Telex: 68136 Emitac Sh  
CH,CS,E,M,P

## UNITED KINGDOM

**GREAT BRITAIN**  
Hewlett-Packard Ltd.  
Trafalgar House  
Navigation Road  
**ALTRINCHAM**  
Cheshire WA14 1NU  
Tel: 061 928 6422  
Telex: 668068  
A,CH,CS,E,M,MS,P  
Hewlett-Packard Ltd.  
Elstree House, Elstree Way  
**BOREHAMWOOD**, Herts WD6 1SG  
Tel: 01 207 5000  
Telex: 8952716  
E,CH,CS,P

Hewlett-Packard Ltd.  
Oakfield House, Oakfield Grove  
Clifton **BRISTOL**, Avon BS8 2BN  
Tel: 0272 736806  
Telex: 444302  
CH,CS,E,P

Hewlett-Packard Ltd.  
Bridewell House  
Bridewell Place  
**LONDON EC4V 6BS**  
Tel: 01 583 6565  
Telex: 298163  
CH,CS,P

Hewlett-Packard Ltd.  
Fourier House  
257-263 High Street  
**LONDON COLNEY**  
Herts. AL2 1HA, St. Albans  
Tel: 0727 24400  
Telex: 1-8952716  
CH,CS

Hewlett-Packard Ltd.  
Pontefract Road  
**NORMANTON**, West Yorkshire WF6 1RN  
Tel: 0924 895566  
Telex: 557355  
CH,CS,P

Hewlett-Packard Ltd.  
The Quadrangle  
106-118 Station Road  
**REDHILL**, Surrey RH1 1PS  
Tel: 0737 68655  
Telex: 947234  
CH,CS,E,P

# SALES & SUPPORT OFFICES

Arranged alphabetically by country



## GREAT BRITAIN (Cont'd)

Hewlett-Packard Ltd.  
Avon House  
435 Stratford Road  
Shirley, SOLIHULL, West Midlands  
B90 4BL  
Tel: 021 745 8800  
Telex: 339105  
CH,CS,E,P

Hewlett-Packard Ltd.  
West End House  
41 High Street, West End  
SOUTHAMPTON  
Hampshire SO3 3DQ  
Tel: 04218 6767  
Telex: 477138  
CH,CS,P

Hewlett-Packard Ltd.  
Eskdale Rd.  
Winnersh, WOKINGHAM  
Berkshire RG11 5DZ  
Tel: 0734 696622  
Telex: 848884  
E

Hewlett-Packard Ltd.  
King Street Lane  
Winnersh, WOKINGHAM  
Berkshire RG11 5AR  
Tel: 0734 784774  
Telex: 847178  
A,CH,CS,E,M,MP,P

Hewlett-Packard Ltd.  
Nine Mile Ride  
Eaishampstead, WOKINGHAM  
Berkshire, 3RG11 3LL  
Tel: 0344 773100  
Telex: 848805  
CH,CS,E,P

## IRELAND

### NORTHERN IRELAND

Hewlett-Packard Ltd.  
Cardiac Services Building  
95A Finaghy Road South  
BELFAST BT10 0BY  
Tel: 0232 625-566  
Telex: 747626  
CH,CS

### SCOTLAND

Hewlett-Packard Ltd.  
SOUTH QUEENSFERRY  
West Lothian, EH30 9TG  
Tel: 031 331 1188  
Telex: 72682  
CH,CM,CS,E,M,P

## UNITED STATES

### Alabama

Hewlett-Packard Co.  
700 Century Park South, Suite 128  
BIRMINGHAM, AL 35226  
Tel: (205) 822-6802  
A,CH,M

Hewlett-Packard Co.  
420 Wynn Drive  
HUNTSVILLE, AL 35805  
P.O. Box 7700  
HUNTSVILLE, AL 35807  
Tel: (205) 830-2000  
CH,CM,CS,E,M\*

### Arizona

Hewlett-Packard Co.  
3080 Pointe Parkway West  
PHOENIX, AZ 85044  
Tel: (602) 273-8000  
A,CH,CM,CS,E,MS

Hewlett-Packard Co.  
2424 East Aragon Road  
TUCSON, AZ 85706  
Tel: (602) 889-4631  
CH,E,MS\*\*

### California

Hewlett-Packard Co.  
99 South Hill Dr.  
BRISBANE, CA 94005  
Tel: (415) 330-2500  
CH,CS

Hewlett-Packard Co.  
P.O. Box 7830 (93747)  
5060 E. Clinton Avenue, Suite 102  
FRESNO, CA 93727  
Tel: (209) 252-9652  
CH,CS,MS

Hewlett-Packard Co.  
P.O. Box 4230  
1430 East Orangethorpe  
FULLERTON, CA 92631  
Tel: (714) 870-1000  
CH,CM,CS,E,MP

Hewlett-Packard Co.  
320 S. Kellogg, Suite B  
GOLETA, CA 93117  
Tel: (805) 967-3405  
CH

Hewlett-Packard Co.  
5400 W. Rosecrans Boulevard  
LAWNDALE, CA 90260  
P.O. Box 92105  
LOS ANGELES, CA 90009  
Tel: (213) 970-7500  
Telex: 910-325-6608  
CH,CM,CS,MP

Hewlett-Packard Co.  
3155 Porter Oaks Drive  
PALO ALTO, CA 94304  
Tel: (415) 857-8000  
CH,CS,E

Hewlett-Packard Co.  
4244 So. Market Court, Suite A  
P.O. Box 15976  
SACRAMENTO, CA 95852  
Tel: (916) 929-7222  
A\*,CH,CS,E,MS

Hewlett-Packard Co.  
9606 Aero Drive  
P.O. Box 23333  
SAN DIEGO, CA 92139  
Tel: (619) 279-3200  
CH,CM,CS,E,MP

Hewlett-Packard Co.  
2305 Camino Ramon "C"  
SAN RAMON, CA 94583  
Tel: (415) 838-5900  
CH,CS

Hewlett-Packard Co.  
3005 Scott Boulevard  
SANTA CLARA, CA 95050  
Tel: (408) 988-7000  
Telex: 910-338-0586  
A,CH,CM,CS,E,MP

Hewlett-Packard Co.  
5703 Corsa Avenue  
WESTLAKE VILLAGE, CA 91362  
Tel: (213) 706-6800  
E\*,CH\*,CS\*

### Colorado

Hewlett-Packard Co.  
24 Inverness Place, East  
ENGLEWOOD, CO 80112  
Tel: (303) 649-5000  
A,CH,CM,CS,E,MS

### Connecticut

Hewlett-Packard Co.  
47 Barnes Industrial Road South  
P.O. Box 5007  
WALLINGFORD, CT 06492  
Tel: (203) 265-7801  
A,CH,CM,CS,E,MS

### Florida

Hewlett-Packard Co.  
2901 N.W. 62nd Street  
P.O. Box 24210  
FORT LAUDERDALE, FL 33307  
Tel: (305) 973-2600  
CH,CS,E,MP

Hewlett-Packard Co.  
6177 Lake Ellenor Drive  
P.O. Box 13910  
ORLANDO, FL 32859  
Tel: (305) 859-2900  
A,CH,CM,CS,E,MS

Hewlett-Packard Co.  
5750B N. Hoover Blvd., Suite 123  
P.O. Box 15200  
TAMPA, FL 33614  
Tel: (813) 884-3282  
A\*,CH,CM,CS,E\*,M\*

### Georgia

Hewlett-Packard Co.  
2000 South Park Place  
P.O. Box 105005  
ATLANTA, GA 30348  
Tel: (404) 955-1500  
Telex: 810-766-4890  
A,CH,CM,CS,E,MP

### Hawaii

Hewlett-Packard Co.  
Kawaiahao Plaza, Suite 190  
567 South King Street  
HONOLULU, HI 96813  
Tel: (808) 526-1555  
A,CH,E,MS

### Illinois

Hewlett-Packard Co.  
304 Eldorado Road  
P.O. Box 1607  
BLOOMINGTON, IL 61701  
Tel: (309) 662-9411  
CH,MS\*\*

Hewlett-Packard Co.  
1100 31st Street, Suite 100  
DOWNS GROVE, IL 60515  
Tel: (312) 960-5760  
CH,CS

Hewlett-Packard Co.  
5201 Tollview Drive  
ROLLING MEADOWS, IL 60008  
Tel: (312) 255-9800  
Telex: 910-687-1066  
A,CH,CM,CS,E,MP

### Indiana

Hewlett-Packard Co.  
7301 No. Shadeland Avenue  
P.O. Box 50807  
INDIANAPOLIS, IN 46250  
Tel: (317) 842-1000  
A,CH,CM,CS,E,MS

### Iowa

Hewlett-Packard Co.  
1776 22nd Street, Suite 1  
WEST DES MOINES, IA 50265  
Tel: (515) 224-1435  
CH,MS\*\*

### Kansas

Hewlett-Packard Co.  
7804 East Funston Road, #203  
WICHITA, KS 67207  
Tel: (316) 684-8491  
CH

### Kentucky

Hewlett-Packard Co.  
10300 Linn Station Road, #100  
LOUISVILLE, KY 40223  
Tel: (502) 426-0100  
A,CH,CS,MS

### Louisiana

Hewlett-Packard Co.  
160 James Drive East  
ST. ROSE, LA 70087  
P.O. Box 1449  
KENNER, LA 70063  
Tel: (504) 467-4100  
A,CH,CS,E,MS

### Maryland

Hewlett-Packard Co.  
3701 Koppers Street  
BALTIMORE, MD 21227  
Tel: (301) 644-5800  
Telex: 710-862-1943  
A,CH,CM,CS,E,MS

Hewlett-Packard Co.  
2 Choke Cherry Road  
ROCKVILLE, MD 20850  
Tel: (301) 948-6370  
A,CH,CM,CS,E,MP

### Massachusetts

Hewlett-Packard Co.  
1775 Minuteman Road  
ANDOVER, MA 01810  
Tel: (617) 882-1500  
A,C,CH,CS,CM,E,MP,P\*  
Hewlett-Packard Co.  
32 Hartwell Avenue  
LEXINGTON, MA 02173  
Tel: (617) 861-8960  
CH,CS,E

### Michigan

Hewlett-Packard Co.  
4326 Cascade Road S.E.  
GRAND RAPIDS, MI 49506  
Tel: (616) 957-1970  
CH,CS,MS

Hewlett-Packard Co.  
1771 W. Big Beaver Road  
TROY, MI 48084  
Tel: (313) 643-6474  
CH,CS

### Minnesota

Hewlett-Packard Co.  
2025 W. Larpenteur Ave.  
ST. PAUL, MN 55113  
Tel: (612) 644-1100  
A,CH,CM,CS,E,MP

### Missouri

Hewlett-Packard Co.  
11131 Colorado Avenue  
KANSAS CITY, MO 64137  
Tel: (816) 763-8000  
A,CH,CM,CS,E,MS

Hewlett-Packard Co.  
13001 Hollenberg Drive  
BRIDGETON, MO 63044  
Tel: (314) 344-5100  
A,CH,CS,E,MP



# SALES & SUPPORT OFFICES

Arranged alphabetically by country

## UNITED STATES (Cont'd)

### Nebraska

Hewlett-Packard  
10824 Old Mill Rd., Suite 3  
OMAHA, NE 68154  
Tel: (402) 334-1813  
CM,MS

### New Jersey

Hewlett-Packard Co.  
120 W. Century Road  
PARAMUS, NJ 07652  
Tel: (201) 265-5000  
A,CH,CM,CS,E,MP  
Hewlett-Packard Co.  
60 New England Av. West  
PISCATAWAY, NJ 08854  
Tel: (201) 981-1199  
A,CH,CM,CS,E

### New Mexico

Hewlett-Packard Co.  
11300 Lomas Blvd., N.E.  
P.O. Box 11634  
ALBUQUERQUE, NM 87112  
Tel: (505) 292-1330  
CH,CS,E,MS

### New York

Hewlett-Packard Co.  
5 Computer Drive South  
ALBANY, NY 12205  
Tel: (518) 458-1550  
A,CH,E,MS

Hewlett-Packard Co.  
9600 Main Street  
P.O. Box AC  
CLARENCE, NY 14031  
Tel: (716) 759-8621  
CH

Hewlett-Packard Co.  
200 Cross Keys Office Park  
FAIRPORT, NY 14450  
Tel: (716) 223-9950  
CH,CM,CS,E,MS

Hewlett-Packard Co.  
7641 Henry Clay Blvd.  
LIVERPOOL, NY 13088  
Tel: (315) 451-1820  
A,CH,CM,E,MS

Hewlett-Packard Co.  
No. 1 Pennsylvania Plaza  
55th Floor  
34th Street & 8th Avenue  
MANHATTAN NY 10119  
Tel: (212) 971-0800  
CH,CS,E\*,M\*

Hewlett-Packard Co.  
250 Westchester Avenue  
WHITE PLAINS, NY 10604  
Tel: (914) 684-6100  
CM,CH,CS,E

Hewlett-Packard Co.  
3 Crossways Park West  
WOODBURY, NY 11797  
Tel: (516) 921-0300  
A,CH,CM,CS,E,MS

### North Carolina

Hewlett-Packard Co.  
5605 Roanne Way  
P.O. Box 26500  
GREENSBORO, NC 27420  
Tel: (919) 852-1800  
A,CH,CM,CS,E,MS

### Ohio

Hewlett-Packard Co.  
9920 Carver Road  
CINCINNATI, OH 45242  
Tel: (513) 891-9870  
CH,CS,MS

Hewlett-Packard Co.  
16500 Sprague Road  
CLEVELAND, OH 44130  
Tel: (216) 243-7300  
A,CH,CM,CS,E,MS

Hewlett-Packard Co.  
962 Crupper Ave.  
COLUMBUS, OH 43229  
Tel: (614) 436-1041  
Eff: Nov. 25, 1983  
675 Brookside Blvd.  
WESTERVILLE, OH 43081  
CH,CM,CS,E\*

Hewlett-Packard Co.  
330 Progress Rd.  
DAYTON, OH 45449  
Tel: (513) 859-8202  
A,CH,CM,E\*,MS

### Oklahoma

Hewlett-Packard Co.  
304 N. Meridian, Suite A  
P.O. Box 75609  
OKLAHOMA CITY, OK 73147  
Tel: (405) 946-9499  
A\*,CH,E\*,MS

Hewlett-Packard Co.  
3840 S. 103rd E. Avenue, #100  
P.O. Box 35747  
TULSA, OK 74153  
Tel: (918) 665-3300  
A\*\*,CH,CS,M\*

### Oregon

Hewlett-Packard Co.  
9255 S. W. Pioneer Court  
P.O. Box 328  
WILSONVILLE, OR 97070  
Tel: (503) 682-8000  
A,CH,CS,E\*,MS

### Pennsylvania

Hewlett-Packard Co.  
111 Zeta Drive  
PITTSBURGH, PA 15238  
Tel: (412) 782-0400  
A,CH,CS,E,MP

Hewlett-Packard Co.  
2750 Monroe Boulevard  
P.O. Box 713  
VALLEY FORGE, PA 19482  
Tel: (215) 666-9000  
A,CH,CM,E,M

### South Carolina

Hewlett-Packard Co.  
Brookside Park, Suite 122  
1 Harbison Way  
P.O. Box 21708  
COLUMBIA, SC 29221  
Tel: (803) 732-0400  
CH,E,MS

Hewlett-Packard Co.  
Koger Executive Center  
Chesterfield Bldg., Suite 124  
GREENVILLE, SC 29615  
Tel: (803) 297-4120

### Tennessee

Hewlett-Packard Co.  
224 Peters Road, Suite 102  
P.O. Box 22490  
KNOXVILLE, TN 37922  
Tel: (615) 691-2371  
A\*,CH,MS

Hewlett-Packard Co.  
3070 Directors Row  
MEMPHIS, TN 38131  
Tel: (901) 346-8370  
A,CH,MS

### Texas

Hewlett-Packard Co.  
4171 North Mesa  
Suite C-110  
EL PASO, TX 79902  
Tel: (915) 533-3555  
CH,E\*,MS\*\*

Hewlett-Packard Co.  
10535 Harwin Drive  
P.O. Box 42816  
HOUSTON, TX 77042  
Tel: (713) 776-6400  
A,CH,CM,CS,E,MP

Hewlett-Packard Co.  
930 E. Campbell Rd.  
P.O. Box 1270  
RICHARDSON, TX 75080  
Tel: (214) 231-6101  
A,CH,CM,CS,E,MP

Hewlett-Packard Co.  
1020 Central Parkway South  
P.O. Box 32993  
SAN ANTONIO, TX 78216  
Tel: (512) 494-9336  
CH,CS,E,MS

### Utah

Hewlett-Packard Co.  
3530 W. 2100 South  
SALT LAKE CITY, UT 84119  
Tel: (801) 974-1700  
A,CH,CS,E,MS

### Virginia

Hewlett-Packard Co.  
4305 Cox Road  
GLEN ALLEN, VA 23060  
P.O. Box 9669  
RICHMOND, VA 23228  
Tel: (804) 747-7750  
A,CH,CS,E,MS

### Washington

Hewlett-Packard Co.  
15815 S.E. 37th Street  
BELLEVUE, WA 98006  
Tel: (206) 643-4000  
A,CH,CM,CS,E,MP

Hewlett-Packard Co.  
Suite A  
708 North Argonne Road  
SPOKANE, WA 99212  
Tel: (509) 922-7000  
CH,CS

### West Virginia

Hewlett-Packard Co.  
4604 MacCorkle Ave.  
P.O. Box 4297  
CHARLESTON, WV 25304  
Tel: (304) 925-0492  
A,MS

### Wisconsin

Hewlett-Packard Co.  
150 S. Sunny Slope Road  
BROOKFIELD, WI 53005  
Tel: (414) 784-8800  
A,CH,CS,E\*,MP

## URUGUAY

*Pablo Ferrando S.A.C. e. l.*  
*Avenida Italia 2877*  
*Casilla de Correo 370*  
**MONTEVIDEO**  
Tel: 80-2586  
Telex: Public Booth 901  
A,C,M,E,M

## VENEZUELA

Hewlett-Packard de Venezuela C.A.  
3RA Transversal Los Ruices Norte  
Edificio Segre 1, 2 & 3  
Apartado 50933  
**CARACAS 1071**  
Tel: 239-4133  
Telex: 251046 HEWPACK  
A,CH,CS,E,MS,P  
Hewlett-Packard de Venezuela C.A.  
Calle-72-Entre 3H y 3Y, No. 3H-40  
Edificio Ada-Evelyn, Local B  
Apartado 2646  
4001, **MARACAIBO**, Estado Zulia  
Tel: (061) 80.304  
C,E\*

Hewlett-Packard de Venezuela C.A.  
Calle Vargas Rondon  
Edificio Seguros Carabobo, Piso 10  
**VALENCIA**  
Tel: (041) 51 385  
CH,CS,P

*Bioelectronica Medica C.A.*  
*Calle Buen Pastor*  
*Edif. Cota Mil-Piso 2 y Semi Sotano 1*  
*Boleita Norte*  
*Apartado 50710 CARACAS 1050A*  
Tel: 239 84 41  
Telex: 26518

## ZIMBABWE

*Field Technical Sales*  
*45 Kelvin Road, North*  
*P.B. 3458*  
**SALISBURY**  
Tel: 705 231  
Telex: 4-122 RH  
C,E,M,P

July 1983 5952-6900

Indicates main office

*HP distributors are printed in italics.*