

KEITHLEY

Model 236/237/238

SOURCE MEASURE UNITS

QUICK REFERENCE GUIDE

INTRODUCTION

This quick reference guide contains descriptions of various features and information concerning the operation of the Model 236/237/238.

©1990, Keithley Instruments, Inc.
All rights reserved.
Instruments Division
Cleveland, Ohio, U.S.A.
Document Number: 236-905-01 Rev. A

**Asyst is a registered trademark of Asyst Software Technologies.
Hewlett-Packard is a registered trademark of Hewlett-Packard Company.
IBM and AT are registered trademarks and PC/XT is a trademark of International Business Machines, Inc.
PC◊488 is a registered trademark of Capital Equipment Corporation.**

TABLE OF CONTENTS

SAFETY WARNINGS	5
SOURCE MEASURE FUNDAMENTALS	7
BASIC OPERATION	14
SWEEP OPERATION	32
IEEE-488 PROGRAMMING	55
DEVICE-DEPENDENT COMMANDS	55
A — Modify Sweep List	55
B — Bias Operation	56
C — Calibration	57
D — Display	60
F — Source and Function	60
G — Output Data Format	60
H — IEEE Immediate Trigger	61
J — Self-tests	61
K — EOI and Bus Hold-off	61
L — Compliance	62
M — Mask and Serial Poll Byte	63
N — Operate	63
O — Output Sense	63
P — Filter	64
Q — Create/Append Sweep List	64
R — Trigger Control	66
S — Integration Time	66
T — Trigger Configuration	67
U — Status	68
V — High Voltage Control	68
W — Default Delay	68
X — Execute	68
Y — Terminator	69
Z — Suppress	69
DATA FORMATS	71
SRQ MASK and SERIAL POLL BYTE	74
STATUS WORDS	75

SAFETY WARNINGS

The following safety warnings should be observed before using Model 236/237/238 Source Measure Units.

The Model 236/237/238 Source Measure Unit is intended for use by qualified personnel who recognize shock hazards and are familiar with the safety precautions required to avoid possible injury.

Exercise cautions when a shock hazard is present. Lethal voltages may be present on the test fixture or the Source Measure Unit connector jacks. The American National Standards Institute (ANSI) states that a shock hazard exists when voltage levels greater than 30V RMS or 42.4V peak are present. A good safety practice is to expect that hazardous voltage is present in any unknown circuit before measuring.

Inspect the connecting cables, test leads, and jumpers for possible wear, cracks, or breaks before each use.

For maximum safety, do not touch the Source Measure Unit, test fixture, test cables or any other instruments while power is applied to the circuit under test. Turn off all power and discharge any capacitors before connecting or disconnecting cables or jumpers. Also, keep the test fixture lid closed while power is applied to the device under test. Safe operation requires the use of the lid interlock.

Do not touch any object which could provide a current path to the common side of the circuit under test or power line (earth) ground. Always make measurements with dry hands

while standing on a dry, insulated surface capable of withstanding the voltage being measured.

Do not exceed the maximum signal levels of the test fixture, as shown on the rear panel and as defined in the specifications and operation section of the instruction manual.

Connect the  screw of the test fixture to safety earth ground using #18 AWG or larger wire (supplied accessory).

Instrumentation and accessories should not be connected to humans.

The  symbol on a Model 237 indicates that 1000V or more may be present on the terminals. Refer to the Model 236/237/238 Operator's Manuals for detailed operation information.

When a Model 236/237/238 is programmed for remote sensing, hazardous voltage may be present on the SENSE and OUTPUT terminals when the unit is in operate regardless of the programmed voltage or current. To avoid a possible shock hazard, always turn off all power before connecting or disconnecting cables to the Source Measure Unit or the associated test fixture.

For multiple unit interlocked test systems, either keep all Model 236/237/238s powered on, or turn them all off.

SOURCE-MEASURE FUNDAMENTALS

Table 1. Source-Measure Capabilities

Source V	$\pm 100\mu\text{V}$ to $\pm 110\text{V}$
Measure I	$\pm 10\text{fA}$ to $\pm 100\text{mA}$
Source I	$\pm 100\text{fA}$ to $\pm 100\text{mA}$
Measure V	$\pm 10\mu\text{V}$ to $\pm 110\text{V}$
237 Additional Capabilities: Source or Measure up to $\pm 1100\text{V}$ at $\pm 10\text{mA}$ maximum	
238 Additional Capabilities: Source or Measure up to $\pm 1\text{A}$ at $\pm 15\text{V}$ maximum.	

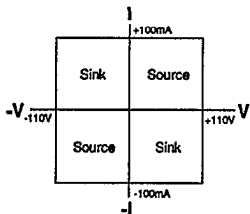

A. Model 236

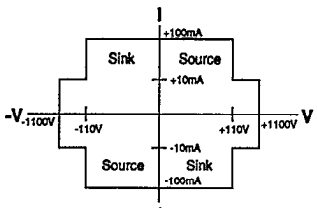

B. Model 237

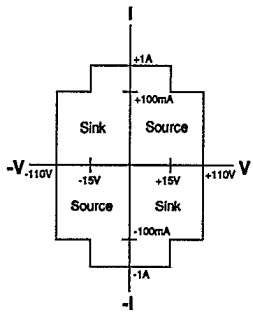

C. Model 238

Figure 1. Source-Measure Capabilities

Source-Delay-Measure

Source Measure Unit operation (dc and sweep) consists of a series of source-delay-measure (SDM) cycles. During each SDM cycle, the following occurs:

- Set the source output level.
- Perform the delay.
- Make the measurement.

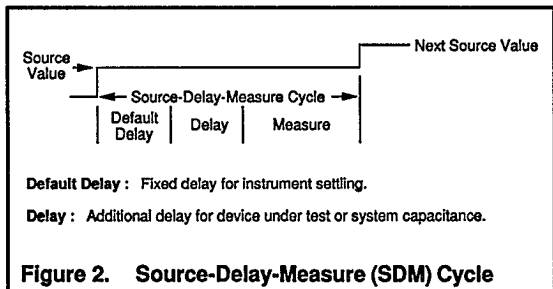

Basic Circuit Configurations

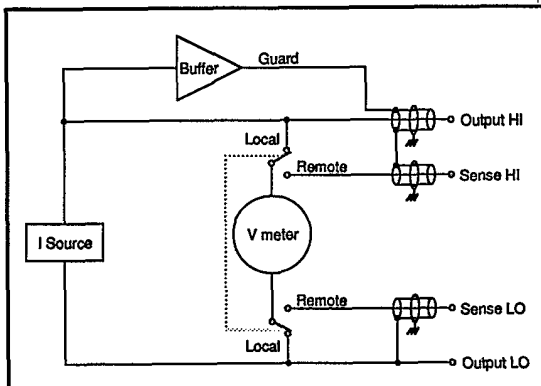

Figure 3. Source I Measure V

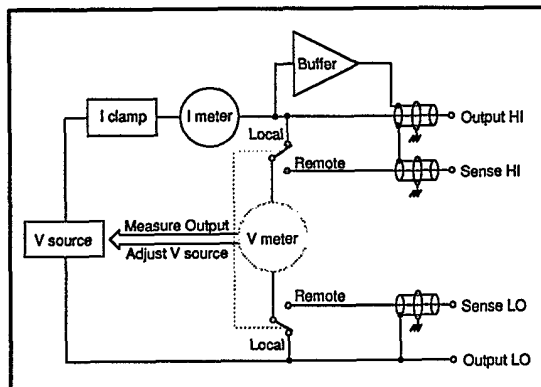

Figure 4. Source V Measure I

Guard

The Source Measure Unit provides a driven guard for OUTPUT HI and SENSE HI. The driven guard is always enabled. When the Source Measure Unit is properly connected to a test fixture, guard is extended to that test fixture.

Guard should always be used when sourcing or measuring low current ($<1\mu\text{A}$) or for high speed measurements (SDM cycle $<10\text{msec}$).

WARNING

GUARD is at the same potential as OUTPUT HI. Thus if lethal voltages are present at OUTPUT HI, they are also present at GUARD.

Basic Connections

WARNING

Safe operation requires that a safety interlock switch be used to interrupt all power sources when the test fixture lid is open or ajar.

WARNING

With remote sensing enabled, an open sense lead will result in lethal voltages appearing at OUTPUT HI and GUARD. This

voltage can cause injury or death, and damage external circuitry. Always make sure that the sense leads are properly connected before enabling remote sense. NEVER change connections with power applied. Be sure to always discharge and/or disconnect external power sources.

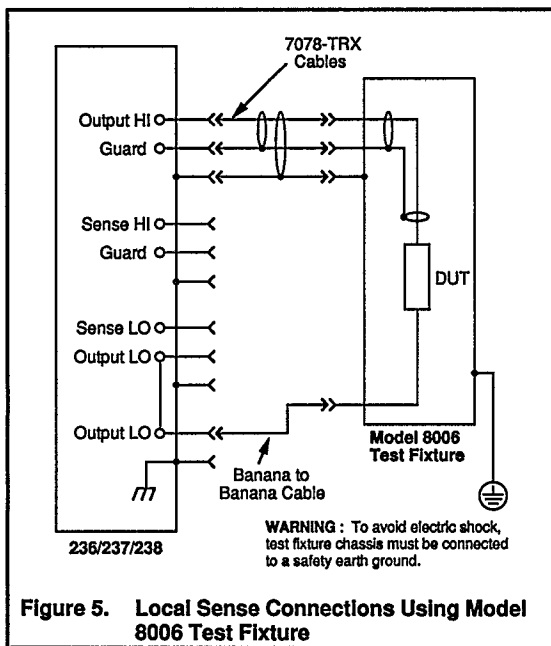

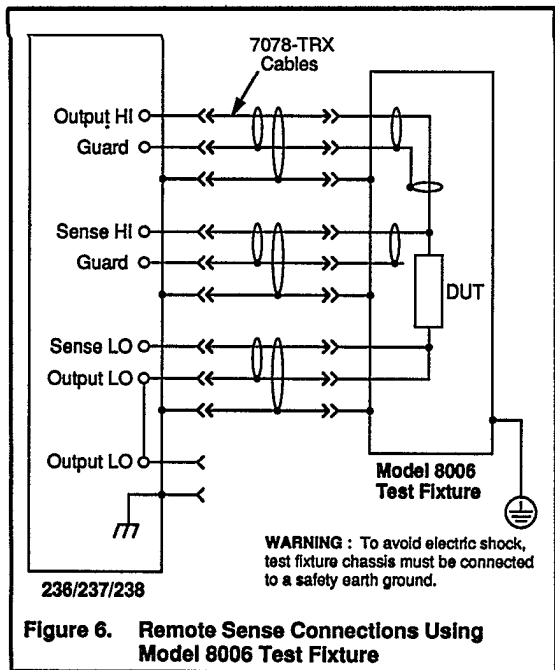

Figure 6. Remote Sense Connections Using Model 8006 Test Fixture

BASIC OPERATION

Table 2. Display Messages

Message	Description
BUFFER FILLED	Number of generated sweep points exceeds the buffer capacity.
CAL CONSTANTS ERR	Power-up verification of cal constants finds one or more values outside of pre-determined limits; default value(s) used for values out of limits.
CAL INVALID ERR	One or more cal errors present on power-up, DCL, or SDC.
DPRAM LINK ERR	Communication error in the dual port RAM between the I/O controller and source/measure controller. Unit is not functional.
DPRAM LOCKUP	ROM or RAM failure in source/measure controller so it is not responding to I/O controller. Unit is not functional.
GENERATING SWEEP	Unit is creating or appending a sweep from the front panel.
IDDC	Unit received an illegal device-dependent command.

Display Messages (Cont.)

Message	Description
IDDCO	Unit received an illegal device-dependent command option.
ILLEGAL MEAS RANGE	Select measure range is incompatible with source (V or I) or unit (236, 237, or 238).
ILLEGAL SRC RANGE	Select source range is incompatible with source (V or I) or unit (236, 237, or 238).
INTERLOCK PRESENT	Attempted to go into operate with an interlock condition present, or an interlock condition exists while in operate.
INVALID SWEEP MIX	Cannot create/append different sweep types (pulsed and non-pulsed) in buffer.
IOU CAL CHCKSUM	Power-up checksum test of cal constants failed.
IOU DPRAM FAILED	Dual port RAM in I/O controller failed. Unit is not functional.
IOU EEROM FAILED	Electrically erasable ROM in IOU controller failed. Unit is not functional.
LOG CANNOT CROSS 0	Cannot create/append a log sweep that passes through zero.

Display Messages (Cont.)

Message	Description
MEAS RANGE CHANGED	Cannot have source and measure ranges of 1100V and 100mA (237), or 110V and 1A (238), at same time; measurement range lowered.
MUST CREATE SWEEP	Attempted to append or modify a non-existent sweep.
NO AUTO IN PULSE	Cannot select source autoranging with a pulse sweep create or append.
NOT IN REMOTE	Sent an X command when the unit was not in remote (REN is false).
OFLO	An external power source has overflowed the measurement hardware in the Model 236/237/238.
PULSE TIME NOT MET	Specified pulse times (t_{ON} and t_{OFF}) cannot be met and will be extended.
PENDING TRIGGER	Waiting to finish previous operation before processing trigger.
TRIGGER OVERRUN	Unit was triggered while still processing a previous trigger; trigger is ignored.
UNCALIBRATED	No cal constants are stored in EEPROM (Source/Measure LED blinks).

Display Messages (Cont.)

Message	Description
VALUE OUT OF RANGE	Selected source value exceeds source range, or selected compliance value exceeds measurement range, or incremental source values are too small for selected range.
236 UNIT	Sent 1kV calibration commands to a Model 236.
65.000 SECONDS MAX	Cannot have a dc or sweep delay greater than 65.000 seconds. Value defaults to 65.000 seconds.
1F	Power-up or memory test of IOU RAM failed. Unit is not functional.
2F	Power-up memory test of IOU ROM failed. Unit is not functional.

MENU

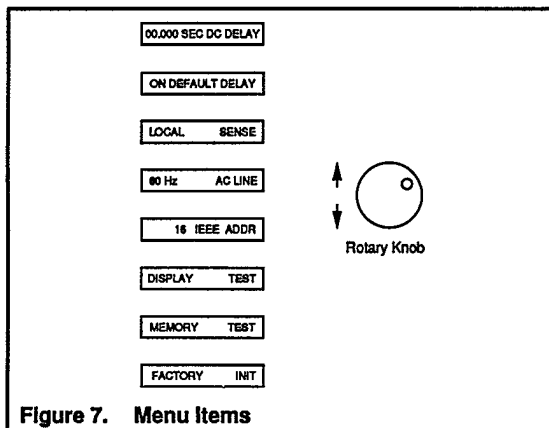
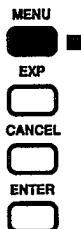

Table 3. MENU Items Description

MENU Item	Description
Dc Delay	Used for dc operation. Provides additional time for source to settle.
Default Delay	Allows for internal settling on low current ranges.
Sense	Used to select local or remote sensing. Use remote sensing when sourcing or measuring >1 mA (see next WARNING).
Ac Line	Use to set instrument to available line frequency (50 or 60Hz). Changing the line frequency also changes the integration time if LINE CYCLE PERIOD is presently selected (see f Time).
IEEE Addr	Use to check or change IEEE-488 interface address (0 to 30).
Display Test	Turns on all display LED segments and front panel indicators.
Memory Test	Tests internal memory elements.
Factory Init	Restores factory default conditions.

WARNING

With remote sensing enabled, an open sense lead will result in lethal voltages appearing at OUTPUT HI and GUARD. This voltage can cause injury or death, and damage external circuitry. Always make sure that the sense leads are properly connected before enabling remote sense. Never change connections with power applied. Be sure to always discharge and/or disconnect external power sources.

Table 4. Default Delay

Range Source or Measure	Delay (msec)
1nA	360
10nA	75
100nA	20
1uA	5
10uA	2
100uA	0
1mA	0
10mA	0
100mA	0
1A	0

MENU Procedure

1. Press MENU.
2. Use the rotary knob to display the desired menu item

NOTE

To perform a self test or factory initialization, press ENTER.

3. To change a menu item parameter, use the keypad or SELECT buttons.
4. Press ENTER.
5. Repeat steps 2, 3 and 4 as needed. Exception: MENU will disable if FACTORY INIT is performed.
6. Press MENU to return to the source-measure display state.

SOURCE AND FUNCTION

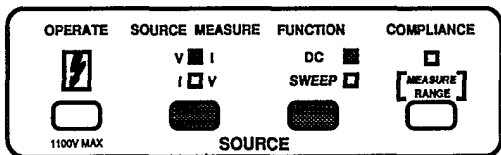

Table 5. Voltage Source Ranges

Model	Range (Max Output)	Resolution
236, 237 238	$\pm 1.1000\text{V}$ $\pm 1.5000\text{V}$	100 μV
236, 237 238	$\pm 11.000\text{V}$ $\pm 15.000\text{V}$	1mV
236, 237, 238 237	$\pm 110.00\text{V}$ $\pm 1100.0\text{V}$	10mV 100mV

Table 6. Current Source Ranges

Range (Max Output)	Resolution
$\pm 1.0000\text{nA}$	100fA
$\pm 10.000\text{nA}$	1pA
$\pm 100.00\text{nA}$	10pA
$\pm 1.0000\mu\text{A}$	100pA
$\pm 10.000\mu\text{A}$	1nA
$\pm 100.00\mu\text{A}$	10nA
$\pm 1.0000\text{mA}$	100nA
$\pm 10.000\text{mA}$	1 μA
$\pm 100.00\text{mA}$	10 μA
$\pm 1.0000\text{A}^*$	100 μA

*Model 238 only

Selecting Source and Function

The desired source (V or I) is selected by pressing SOURCE MEASURE, and function (dc or sweep) is selected by pressing FUNCTION. If the Manual Trigger light is blinking, press TRIGGER.

For dc operation, a source value can be set using the rotary knob and SELECT buttons, or by keying in a value from the keypad and pressing ENTER.

Changing the Source Range (dc operation)

The position of the decimal point indicates the source range. For example, a reading of +002.00V indicates that the 110V range is selected, while a reading of +02.000V indicates that the 11V or 15V range is selected.

To select a different source range, use the SELECT buttons. ◀ SELECT upranges and SELECT ▶ downranges.

COMPLIANCE and MEASURE RANGE

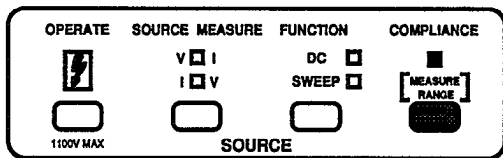

Compliance limits are set in order to protect external circuitry (i.e. DUT) from damage. When sourcing voltage, a current compliance limit is set. Conversely, when sourcing current, a voltage compliance limit is set.

Setting compliance sets the maximum measurement range of the Source Measure Unit. A measurement range that is lower than the compliance value cannot be selected, unless AUTORANGE is enabled.

Table 7. Current Measurement Ranges

Range (Max Output)	Resolution	
	4d	5d
$\pm 1\text{nA}$	100fA	10fA
$\pm 10\text{nA}$	1pA	100fA
$\pm 100\text{nA}$	10pA	1pA
$\pm 1\mu\text{A}$	100pA	10pA
$\pm 10\mu\text{A}$	1nA	100pA
$\pm 100\mu\text{A}$	10nA	1nA
$\pm 1\text{mA}$	100nA	10nA
$\pm 10\text{mA}$	1 μA	100nA
$\pm 100\text{mA}$	10 μA	1 μA
$\pm 1\text{A}^*$	100 μA	10 μA

*Model 238 only

Table 8. Voltage Measurement Ranges

Model	Range (Max Output)	Resolution	
		4d	5d
236, 237 238	$\pm 1.1000\text{V}$ $\pm 1.5000\text{V}$	100 μV	10 μV
236, 237 238	$\pm 11.000\text{V}$ $\pm 15.000\text{V}$	1mV	100 μV
236, 237, 238 237	$\pm 110.00\text{V}$ $\pm 1100.0\text{V}$	10mV 100mV	1mV 10mV

Changing Compliance Limit

Press COMPLIANCE to display the compliance limit. To change the limit, use the SELECT buttons and the rotary knob, or key in the value from the keypad and press ENTER.

Measure Only

The Source Measure Unit can be used as a stand-alone voltmeter or current meter. To measure voltage, select Source I Measure V and set the current source to zero on the 1nA range (0.0000 nA). To measure current, select Source V Measure I and set the voltage source to zero on the 1.1V or 1.5V range (0.0000 V).

Note that positive current flows out of OUTPUT HI.

AUTORANGE

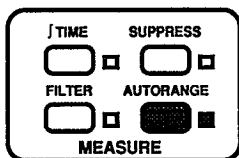

With AUTORANGE enabled, the Source Measure Unit will go to the lowest possible (most sensitive) range to make the measurement. For example, with a 3V compliance limit (11V or 15V range), 0.5V will be measured on the 1.1V or 1.5V range if autorange is enabled.

OPERATE

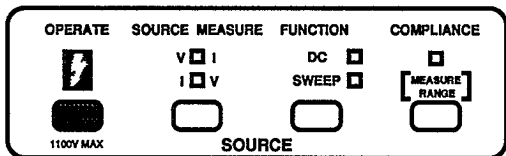

A source cannot be applied to the output unless the unit is in operate. The unit can be placed in standby (OPERATE light off) while the unit is in any display state. Toggling the sources (V to I, or I to V) will also place the unit in standby.

DC Operation — With the dc function selected, enabling operate will apply the source to the output, unless the MANUAL TRIGGER light is blinking. In this case, a trigger is needed to output the source and start making measurements.

Sweep Operation — With the sweep function selected, enabling OPERATE will source (but not measure) the bias level of the sweep. The sweep itself will not start until the appropriate trigger occurs (as denoted by the blinking MANUAL TRIGGER light).

WARNING

To avoid electric shock, always assume that a hazardous voltage is applied to the output when OPERATE is enabled.

TIME

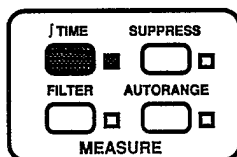

The integration (measure) time for A/D conversions and subsequent usable measurement resolution is selectable from the front panel and over the IEEE-488 bus. When LINECYCLE PERIOD is selected, the integration time depends on the line frequency setting (50 or 60Hz) of the Source Measure Unit (see MENU).

Table 9. Integration Periods and Resolution

Selection	Integration Time	Measurement Resolution
FAST PERIOD	416 μ sec	4 digits
MEDIUM PERIOD	4msec	5 digits
LINE CYCLE PERIOD	60Hz; 16.667msec 50Hz; 20msec	5 digits

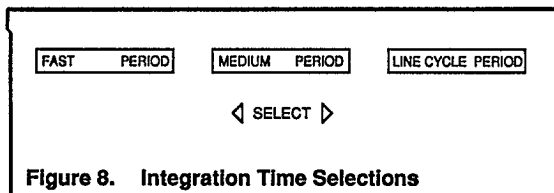

Changing \int Time

Press \int TIME to display the integration period. To change the period, use the SELECT buttons to display the desired period and press ENTER.

FILTER

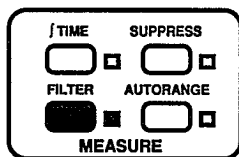

Filtering is used to stabilize noisy measurements. The unit does this by averaging a number of reading conversions and then displaying (or storing) the result. The number of readings that can be averaged (filtered) is 2, 4, 8, 16 or 32. FILTER disabled is synonymous to averaging one reading.

The more filtering used, the quieter the reading. However, filtering increases measurement time, thus decreasing

speed. As a general rule, only use as much filtering as necessary.

Changing FILTER

Press FILTER to display the current filter selection. Use the SELECT buttons to display the desired selection and press ENTER.

SUPPRESS

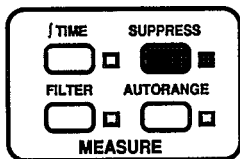

Suppression allows a stored offset value to be subtracted from subsequent measured readings. When SUPPRESS is enabled, the next conversion will be internally stored as a baseline. All subsequent readings will be the difference between the suppressed value and the actual signal level.

Suppressing a value while in dc operation will process readings already stored in the sweep buffer. The suppressed value will be algebraically subtracted from every measurement point in the sweep. This allows you to run a sweep and then afterwards use suppression to cancel an offset. When SUPPRESS is later disabled, the readings in the sweep buffer will return to the original measured values.

The first measurement point of a sweep can be used as the baseline. Prior to starting the sweep, enabling SUPPRESS

will cause its light to start blinking, indicating that it is waiting for a trigger to start the sweep. When the sweep is started, the first measurement point is stored as the baseline, and subsequent measured points reflect this suppressed value. If SUPPRESS is disabled after the sweep is completed, the readings in the sweep buffer will return to the originally measured values.

WARNING

Voltage on the output may be larger than the displayed measured value. For example, if a 75V baseline is stored, a voltage of +100V will result in a displayed measured value of only +25V.

SWEEP OPERATION

Performing A Sweep

With the Source Measure appropriately configured, a sweep is performed by placing the unit in OPERATE and providing the trigger(s) needed to start/control the sweep.

The following steps summarize the basic steps to perform a sweep:

Before using the Source Measure Unit, make sure it is properly connected.

Step 1. Select Source and Sweep Function

To sweep voltage, select Source V Measure I, or to sweep current, select Source I Measure V.

Step 2. Configure Miscellaneous Features and Controls

Features/controls that you may wish to configure or check include; IEEE address (for bus operation), default delay,

sense, integration time, and filter.

Step 3. Create Sweep

Step 4. Append/Modify Sweep (optional)

If desired, the basic sweep created in step 5 can be customized using the append and modify features.

Step 5. Enter Compliance Value

Enter an appropriate compliance value and select an appropriate measurement range.

Step 6. Configure Triggers

Step 7. Place Unit In OPERATE

Step 8. Provide Input Trigger(s)

Depending on how the triggers are configured, one or more input triggers will process the sweep.

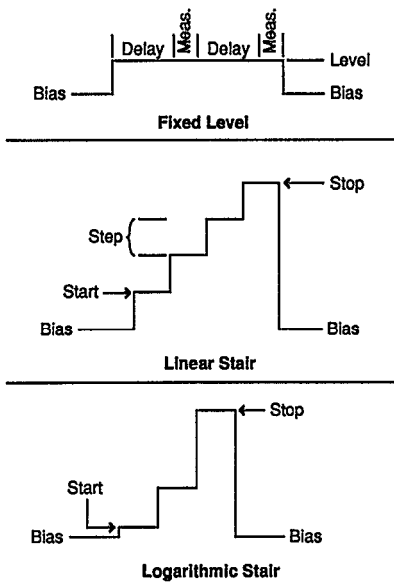
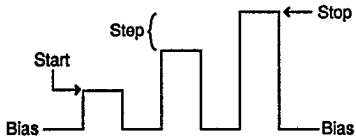

Figure 9. Sweep Waveforms



Pulse



Linear Stair Pulse

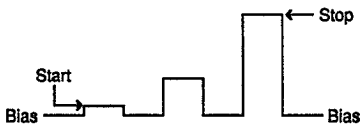

Logarithmic Stair Pulse

Sweep Waveforms (Cont.)

CREATE SWEEP

Step 1. Select Source

To sweep (source) voltage, the Source Measure Unit must be in Source V Measure I. Conversely, to sweep (source) current, the Source Measure Unit must be in Source I Measure V.

Step 2. Enable Sweep CREATE

The currently defined sweep waveform will be displayed.

Step 3. Select Sweep Waveform

Figure 9 shows the sweep waveform selections. Use the SELECT buttons to display the desired sweep waveform and then press ENTER.

Step 4. Define Sweep Parameters

Any parameter of the sweep can be displayed using the rotary knob. Changes to all parameters, except points/decade and range, are accomplished by using the keypad to key-in the value and pressing ENTER. Changes to the points/decade and range parameters are accomplished using the SELECT buttons to display the parameter option and pressing ENTER.

Step 5. Save Sweep Parameters

In order to save sweep parameters, the message "SAVE? ENTER/CANCEL" must be displayed. This message is dis-

played after the range parameter is entered. It can also be displayed by again pressing CREATE.

With "SAVE? ENTER/CANCEL" displayed, press ENTER to save the sweep parameters. Pressing CANCEL will maintain the sweep with the previously programmed definition.

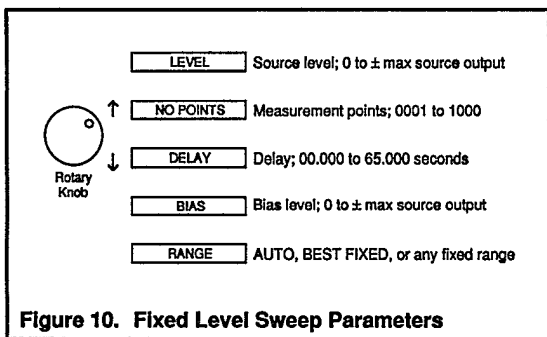

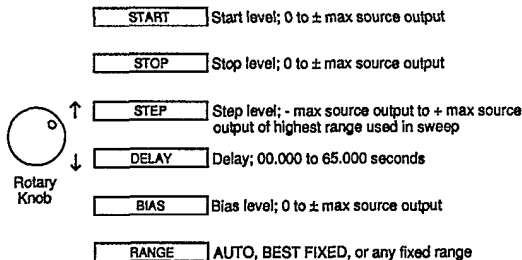

Figure 11. Linear Staircase Sweep Parameters

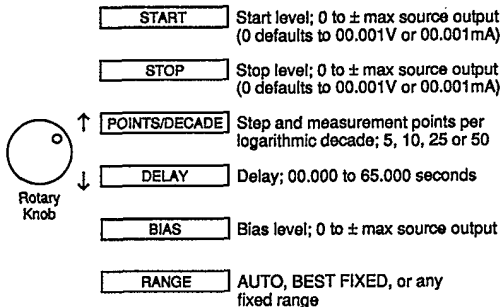

Figure 12. Logarithmic Staircase Sweep Parameters

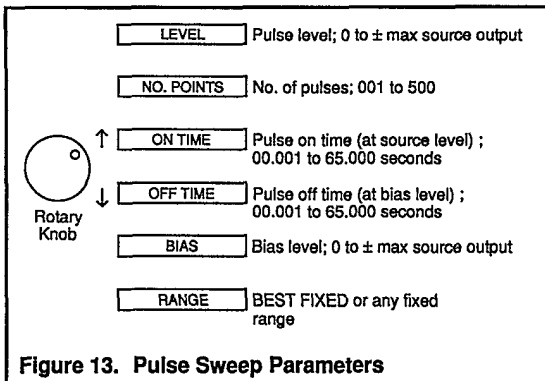

Figure 13. Pulse Sweep Parameters

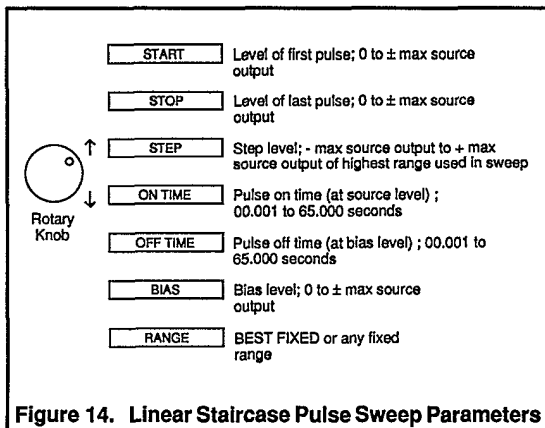

Figure 14. Linear Staircase Pulse Sweep Parameters

 <p>Rotary Knob</p>	START	Level of first pulse; 0 to \pm max source output (0 defaults to 00.001V or 00.001mA)
	STOP	Level of last pulse; 0 to \pm max source output (0 defaults to 00.001V or 00.001mA)
	POINTS/DECADE	No. of pulse and measurement points per logarithmic decade; 5, 10, 25 or 50
	ON TIME	Pulse on time (at source level) ; 00.001 to 65.000 seconds
	OFF TIME	Pulse off time (at bias level) ; 00.001 to 65.000 seconds
	BIAS	Bias level; 0 to \pm max source output
	RANGE	BEST FIXED or any fixed range

Figure 15. Logarithmic Staircase Pulse Sweep Parameters

APPEND SWEEP

The append feature permits one or more waveforms to be appended to the currently defined sweep waveform.

Table 10. APPEND Waveform

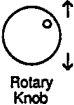
Defined Sweep Waveform	Available APPEND Sweep Waveforms
Fixed level	Fixed level Linear staircase Log staircase
Linear staircase	Fixed level Linear staircase Log staircase
Log staircase	Fixed level Linear staircase Log staircase
Pulse	Pulse Linear staircase pulse Log staircase pulse
Linear staircase pulse	Pulse Linear staircase pulse Log staircase pulse
Log staircase pulse	Pulse Linear staircase pulse Log staircase pulse

Perform the following steps to append a sweep:

Step 1. Enable Sweep APPEND

The same type of sweep that is already defined will be displayed.

If appending the defined sweep with the same (displayed) sweep type, proceed to step 3.

Step 2. Select Sweep Type

Use the SELECT buttons to display the sweep type that you wish to append to the already defined sweep and press ENTER.

Step 3. Define Sweep Parameters

These sweep parameters are entered in the same way that parameters were entered for the original sweep.

Step 4. Save Sweep Parameters

Sweep parameters are saved in the same way that the original sweep parameters were saved.

MODIFY SWEEP

The modify feature permits source level and delay time changes to be made for any measurement point in the cur-

rently defined sweep. This feature allows custom shaped waveforms to be fabricated.

Step 1. Enable Sweep MODIFY.

The source level at the first measure point will be displayed.

Step 2. Modify Source Levels

The rotary knob will display the source level for each measure point in the sweep. To change a source level, perform the following steps:

1. Use the rotary knob to display the measure point .
2. Key-in the new source level from the keypad.
3. Press ENTER. The source range for the original source level will be displayed.
4. If an alternate source range is needed or desired, use the SELECT buttons to display it.
5. Press ENTER. The newly entered source value will be displayed.
6. Repeat steps 1 through 5 to change the source level at another measure point.

Step 3. Modify Delay Times

If one or more delay times are going to be changed, perform the following steps. Otherwise, proceed to step 4.

1. Press SELECT▶. The delay time for one of the measure points will be displayed.
2. Use the rotary knob to display the measure point whose delay is to be changed.

3. Key-in the new delay time from the keypad.
4. Press ENTER. The newly entered delay time will be displayed.
5. Repeat steps 1 through 4 to change the delay time at another measure point.

Step 4. Exit Modify State

To return the Source Measure Unit to the normal source-measure display state press either Sweep MODIFY or ENTER.

TRIGGER SETUP

Input Triggers — Input triggers are used to control when source, delay, and measure operations occur.

Input Trigger Origin — The input trigger stimulus may be provided by the front panel MANUAL trigger button, an external device that applies a TTL level pulse to the TRIGGER IN connector on the rear panel, or an appropriate IEEE-488 operation.

Output Triggers — The Source Measure Unit is capable of sending TTL level output pulses (via its TRIGGER OUT connector) to trigger operations of external devices, such as another Source Measure Unit. The Source Measure Unit can be programmed to output a trigger after any phase of the SDM cycle.

Sweep End Output Trigger — In addition to the previously mentioned output triggers, the Source Measure Unit can

also be programmed to output a trigger pulse at the end of a sweep.

Enable/Disable Triggers— Input and output triggers of the Source Measure Unit can be disabled by the enable/disable triggers setup.

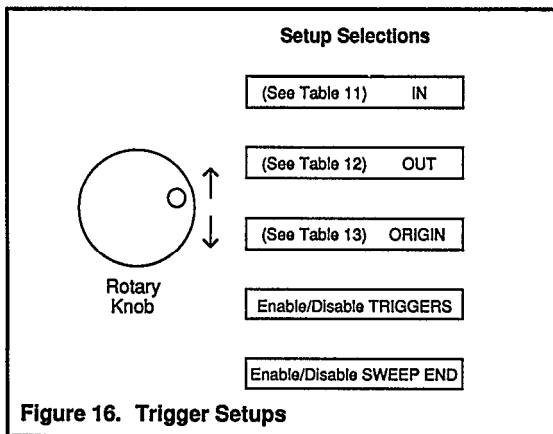

Table 11. Input Triggers

Trigger Selection	Description
CONTINUOUS IN	Continuously process all SDM cycles.
^SRC DLY MSR IN	Each trigger will process an SDM cycle.
SRC·DLY MSR IN	Initial trigger sets source. Each subsequent trigger initiates a delay and measure, then sets source of next SDM cycle.
^SRC·DLY MSR IN	Two triggers process each SDM cycle. First trigger sets source. Second trigger initiates a delays and measure.
SRC DLY·MSR IN	Initial trigger sets source and causes a delay. Second trigger initiates measure, and then, for next SDM cycle, sets source and initiates a delay.
^SRC DLY·MSR IN	Two triggers process each SDM cycle. First trigger sets source and initiates a delay. Second trigger initiates a measure.

Input Triggers (Cont.)

Trigger Selection	Description
SRC·DLY·MSR IN	Initial trigger sets source. Two triggers process each SDM cycle. First trigger initiates a delay. Second trigger initiates a measure and sets source of next SDM cycle.
^SRC·DLY·^MSR IN	Three triggers process each SDM cycle. First trigger sets source. Second trigger initiates a delay. Third trigger initiates a measure.
^SINGLE PULSE IN	Pulse sweep trigger. Each trigger processes the on time (t_{ON}) and off time (t_{OFF}) of each pulse in the sweep. Two measurements are made on each pulse.

Table 12. Output Triggers

Trigger Selection	Description
NONE OUT	No output triggers.
SRC ^Δ DLY MSR OUT	Output trigger pulse after every source phase.
SRC DLY ^Δ MSR OUT	Output trigger pulse after every delay phase.
SRC ^Δ DLY ^Δ MSR OUT	Output trigger pulse after every source phase and delay phase.
SRC DLY MSR ^Δ OUT	Output trigger pulse after every measure phase.
SRC ^Δ DLY MSR ^Δ OUT	Output trigger pulse after every source phase and measure phase.
SRC DLY ^Δ MSR ^Δ OUT	Output trigger pulse after every delay phase and measure phase.
SRC ^Δ DLY ^Δ MSR ^Δ OUT	Output trigger pulse after every source phase, delay phase, and measurement phase.
PULSE END ^Δ OUT	For pulse sweeps. Output trigger pulse after end of each off time (t_{OFF}) measurement.
SWEEP END^Δ Separate output trigger that is not displayed with the other output triggers (see Figure 16)	When enable, an output trigger pulse occurs at the end of the sweep.

Table 13. Input Trigger Origin

Selection	Trigger Stimulus
INTERNAL ORIGIN	Front panel MANUAL trigger button or H0 command over IEEE-488 bus.
EXTERNAL ORIGIN	Negative-going TTL level pulse applied to TRIGGER IN connector.
IEEE TALK ORIGIN	Unit addressed to talk over IEEE-488 bus.
IEEE GET ORIGIN	Group execute trigger (GET) command sent over IEEE-488 bus.
IEEE X ORIGIN	"X" sent over IEEE-488 bus.

Note: Front panel MANUAL trigger button or H0 Command will provide an input trigger with any trigger origin.

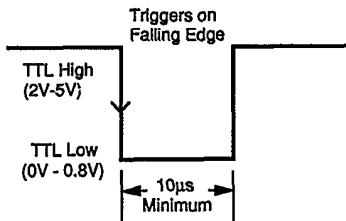
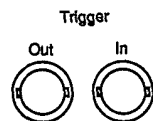
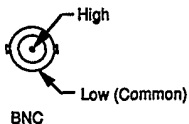

Figure 17. External Input Trigger Pulse Specification



Trigger Common
Connected to Chassis

A. Trigger Connections



B. Trigger In and Out Connector Configuration

Figure 18. Trigger In and Trigger Out Connections

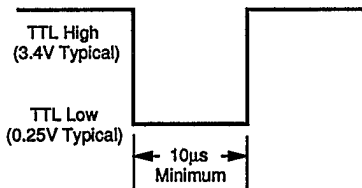

Figure 19. External Output Trigger Pulse Specifications

RECALL SWEEP

Every measurement that occurs in a sweep is stored in the sweep buffer and time stamped. Each time stamp indicates the elapsed time from the start of the sweep to the end of the measurement.

Data is structured in a matrix array. The display of the Source Measure Unit serves as a "window" to view each piece of data in the matrix. When the Source Measure Unit is in SWEEP RECALL, the display "window" is moved around in the matrix with the DATA ENTRY rotary knob and SELECT buttons. The rotary knob moves the "window" vertically, while the SELECT buttons moves the "window" horizontally in the array.

SELECT ▾

SRC/MSR	0001/SRC	0001/MSR	0001/DLY	0001/ΔT	0001/MSR
SRC/MSR	0002/SRC	0002/MSR	0002/DLY	0002/ΔT	0002/MSR
SRC/MSR	0003/SRC	0003/MSR	0003/DLY	0003/ΔT	0003/MSR
•	•	•	•	•	•
•	•	•	•	•	•
•	•	•	•	•	•
SRC/MSR *	1000/SRC	1000/MSR *	1000/DLY	1000/ΔT	1000/MSR

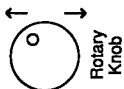

SRC = Source
 MSR = Measure
 DLY = Delay
 ΔT = Elapsed Time

* Will display "COMPLI" if in compliance

Figure 20. Sweep Buffer Data

IEEE-488 PROGRAMMING

DEVICE-DEPENDENT COMMANDS

Modify Sweep List

A(level),(range),(delay),first(,last)

level — Output level of sweep source:

I-source	(236, 237)	-100.00 to +100.00mA
	(238)	-1.0000 to +1.0000A
V-source	(236, 238)	-110.00 to +110.00V
	(237)	-1100.0 to +1100.0V

range — Source range:

	<u>I-source</u>	<u>V-source</u>
0 =	Auto	Auto
1 =	1nA	1.1V (236, 237); 1.5V (238)
2 =	10nA	11V (236, 237); 15V (238)
3 =	100nA	110V
4 =	1 μ A	1100V (237)
5 =	10 μ A	*
6 =	100 μ A	*
7 =	1mA	*
8 =	10mA	*
9 =	100mA	*
10 =	1A (238)	*

*Illegal V-source option.

delay — Sweep delay in msec (0-65000)

first — First data point (1-1000)

last — Last data point (1-1000)

Bias Operation

B(level),(range),(delay)

level — Output level of dc source:

I-source	(236, 237)	-100.00 to +100.00mA
	(238)	-1.0000 to +1.0000A
V-source	(236, 238)	-110.00 to +110.00V
	(237)	-1100.0 to +1100.0V

range — Source range:

	<u>I-source</u>	<u>V-source</u>
0 =	Auto	Auto
1 =	1nA	1.1V (236, 237); 1.5V (238)
2 =	10nA	11V (236, 237); 15V (238)
3 =	100nA	110V
4 =	1 μ A	1100V (237)
5 =	10 μ A	*
6 =	100 μ A	*
7 =	1mA	*
8 =	10mA	*
9 =	100mA	*
10 =	1A (238)	*

*Illegal V-source option.

delay — Dc delay in msec (0-65000)

Calibration

Cstep(,value)X

C0X	Enter calibration procedure
C1X	Common mode adjustment
C2X	Set up +1.1V (236, 237) or +1.5V (238) source and measure offset calibration
C3,VmsrX	Vmsr = Measured voltage
C4X	Set up +1.1V (236, 237) or +1.5V (238) source and measure gain calibration
C5,VmsrX	Vmsr = Measured voltage
C6X	Set up -1.1V (236, 237) or -1.5V (238) source and measure offset calibration
C7,VmsrX	Vmsr = Measured voltage
C8X	Set up -1.1V (236, 237) or -1.5V (238) source and measure gain calibration
C9,VmsrX	Vmsr = Measured voltage
C10X	Set up +11V (236, 237) or +15V (238) source and measure offset calibration
C11,VmsrX	Vmsr = Measured voltage
C12X	Set up +11V (236, 237) or +15V (238) source and measure gain calibration
C13,VmsrX	Vmsr = Measured voltage
C14X	Set up -11V (236, 237) or -15V (238) source and measure offset calibration
C15,VmsrX	Vmsr = Measured voltage
C16X	Set up -11V (236, 237) or -15V (238) source and measure gain calibration
C17,VmsrX	Vmsr = Measured voltage
C18X	Set up +110V source and measure offset calibration
C19,VmsrX	Vmsr = Measured voltage
C20X	Set up +110V source and measure gain calibration

Calibration (Cont.)

C21,VmsrX Vmsr = Measured voltage
C22X Set up -110V source and measure offset calibration

C23,VmsrX Vmsr = Measured voltage
C24X Set up -110V source and measure gain calibration

C25,VmsrX Vmsr = Measured voltage

237/238 only

C26X Set up +1.1kV (237) or +1A (238) source and measure offset calibration

C27,msrX msr = Measured voltage (237) or current (238)

C28X Set up +1.1kV (237) or +1A (238) source and measure gain calibration

C29,msrX msr = Measured voltage (237) or current (238)

C30X Set up -1.1kV (237) or -1A (238) source and measure offset calibration

C31,msrX msr = Measured voltage (237) or current (238)

C32X Set up -1.1kV (237) or -1A (238) source and measure gain calibration

C33,msrX msr = Measured voltage (237) or current (238)

C34X Set up +100mA source and measure offset calibration

C35,lmsrX lmsr = Measured current

C36X Set up +100mA source and measure gain calibration

C37,lmsrX lmsr = Measured current

C38X Set up -100mA source and measure offset calibration

C39,lmsrX lmsr = Measured current

Calibration (Cont.)

C40X	Set up -100mA source and measure gain calibration
C41, lmsrX	lmsr = Measured current
C42X	Perform 1nA measure offset calibration
C43, lsrcX	Perform 1nA measure gain calibration, lsrc = Sourced current
C44X	Perform 10nA measure offset calibration
C45, lsrcX	Perform 10nA measure gain calibration, lsrc = Sourced current
C46X	Perform 100nA measure offset calibration
C47, lsrcX	Perform 100nA measure gain calibration, lsrc = Sourced current
C48X	Perform 1 μ A measure offset calibration
C49, lsrcX	Perform 1 μ A measure gain calibration, lsrc = Sourced current
C50X	Perform 10 μ A measure offset calibration
C51, lsrcX	Perform 10 μ A measure gain calibration, lsrc = Sourced current
C52X	Perform 100 μ A measure offset calibration
C53, lsrcX	Perform 100 μ A measure gain calibration, lsrc = Sourced current
C54X	Perform 1mA measure offset calibration
C55, lsrcX	Perform 1mA measure gain calibration, lsrc = Sourced current
C56X	Perform 10mA measure offset calibration
C57, lsrcX	Perform 10mA measure gain calibration, lsrc = Sourced current
C58X	Perform 1nA to 10mA source calibration
C59X	Exit calibration procedure

Display

D0X	Return display to normal operation
D1,aaa...aX	Display ASCII characters (18 max.)
D2,aaa...aX	Display ASCII characters and store in memory (18 max.)

Source and Function

F(source),(function)

F0,0	Source V	Measure I	dc
F0,1	Source V	Measure I	Sweep
F1,0	Source I	Measure V	dc
F1,1	Source I	Measure V	Sweep

Output Data Format

G(items),(format),(lines)

items — Sum of items in IEEE output string (0–15):

- 0 = No items
- 1 = Source value
- 2 = Delay value
- 4 = Measure value
- 8 = Time value

format — Format of IEEE output string:

- 0 = ASCII data with prefix and suffix
- 1 = ASCII data with prefix, no suffix
- 2 = ASCII data, no prefix or suffix
- 3 = HP binary data
- 4 = IBM binary data

Output Data Format (Cont.)

lines — Number of lines per output:

0 = One line of dc data per talk

1 = One line of sweep data per talk

2 = All lines of sweep data per talk

IEEE Immediate Trigger

H0X Cause immediate trigger

Self-tests

J0X Restore factory defaults

J1X Perform memory test

J2X Perform display test

EOI and Bus Hold-off

K0 Enable EOI Enable bus hold-off on X

K1 Disable EOI Enable bus hold-off on X

K2 Enable EOI Disable bus hold-off on X

K3 Disable EOI Disable bus hold-off on X

Compliance

L(level),(range)

level — Compliance level:

I-measure (236, 237)	-100.00 to +100.00mA
(238)	-1.0000 to +1.0000A
V-measure(236, 238)	-110.00 to +110.00V
(237)	-1100.0 to +1100.0V

range — Compliance/measurement range:

	<u>I-measure</u>	<u>V-measure</u>
0 =	Auto	Auto
1 =	1nA	1.1V (236, 237); 1.5V (238)
2 =	10nA	11V (236, 237); 15V (238)
3 =	100nA	110V
4 =	1 μ A	1100V (237)
5 =	10 μ A	*
6 =	100 μ A	*
7 =	1mA	*
8 =	10mA	*
9 =	100mA	*
10 =	1A (238)	*

*Illegal V-measure option.

SRQ Mask and Serial Poll Byte

M(mask),(compliance)

mask — Sum of bits in SRQ mask:

0 = SRQ disabled

1 = Warning

2 = Sweep Done

4 = Trigger Out

8 = Reading Done

16 = Ready for Trigger

32 = Error

128 = Compliance

compliance — SRQ on compliance:

0 = During delay or measure phase or idle time

1 = During measure phase

Operate

N0	Standby
N1	Operate

Output Sense

O0	Local sense
O1	Remote sense

Filter

P0	Filter disabled
P1	2 readings
P2	4 readings
P3	8 readings
P4	16 readings
P5	32 readings

Create/Append Sweep List

- Q0,(level),(range),(delay),(count)
Create fixed level sweep
- Q1,(start),(stop),(step),(range),(delay)
Create linear stair sweep
- Q2,(start),(stop),(points),(range),(delay)
Create logarithmic stair sweep
- Q3,(level),(range),(pulses),(ton),(toff)
Create fixed level pulsed sweep
- Q4,(start),(stop),(step),(range),(ton),(toff)
Create linear stair pulsed sweep
- Q5,(start),(stop),(points),(range),(ton),(toff)
Create logarithmic stair pulsed sweep
- Q6,(level),(range),(delay),(count)
Append fixed level sweep
- Q7,(start),(stop),(step),(range),(delay)
Append linear stair sweep
- Q8,(start),(stop),(points),(range),(delay)
Append logarithmic stair sweep
- Q9,(level),(range),(pulses),(ton),(toff)
Append fixed level pulsed sweep
- Q10,(start),(stop),(step),(range),(ton),(toff)
Append linear stair pulsed sweep
- Q11,(start),(stop),(points),(range),(ton),(toff)
Append logarithmic stair pulsed sweep

Create/Append Sweep List (Cont.)

count — Number of S-D-M cycles in sweep (1-1000)

delay — Sweep delay in msec (0-65000)

level — Output level of sweep source:

I-source	(236, 237)	-100.00 to +100.00mA
	(238)	-1.0000 to +1.0000A
V-source	(236, 238)	-110.00 to +110.00V
	(237)	-1100.0 to +1100.0V

points — Logarithmic points per decade:

0 = 5 points/decade

1 = 10 points/decade

2 = 25 points/decade

3 = 50 points/decade

pulses — Pulse quantity (0-500)

range — Source range:

	<u>I-source</u>	<u>V-source</u>
0 =	Auto**	Auto**
1 =	1nA	1.1V (236, 237); 1.5V (238)
2 =	10nA	11V (236, 237); 15V (238)
3 =	100nA	110V
4 =	1 μ A	1100V (237)
5 =	10 μ A	*
6 =	100 μ A	*
7 =	1mA	*
8 =	10mA	*
9 =	100mA	*
10 =	1A (238)	*

*Illegal V-source option.

**No pulsed sweeps

Create/Append Sweep List (Cont.)

start, stop — Start and stop source values for stair sweeps.

I-source	(236, 237)	-100.00 to +100.00mA
	(238)	-1.0000 to +1.0000A
V-source	(236, 238)	-110.00 to +110.00V
	(237)	-1100.0 to +1100.0V

step — Incremental absolute value for stair sweeps.

I-source	(236, 237)	-200.00 to +200.00mA
	(238)	-2.0000 to +2.0000A
V-source	(236, 238)	-220.00 to +220.00V
	(237)	-2200.0 to +2200.0V

ton — Duration of sweep level in msec (0-65000)

toff — Duration of bias level in msec (0-65000)

Trigger Control

R0	Disable input triggering and generation of output triggers
R1	Enable input triggering and generation of output triggers

Integration Time

S0	416 μ sec integration time, Fast, 4-digit resolution
S1	4msec integration time, Medium, 5-digit resolution
S2	16.67msec integration time, 60Hz ac line, 5-digit resolution
S3	20msec integration time, 50Hz ac line, 5-digit resolution

Trigger Configuration (Cont.)

T(origin),(in),(out),(end)

origin — Input trigger origin:

- 0 = IEEE X
- 1 = IEEE GET
- 2 = IEEE Talk
- 3 = External (TRIGGER IN pulse)
- 4 = Immediate only (MANUAL key or H0X command)

in — Input trigger effect:

- 0 = Continuous (no trigger needed to continue S-D-M)
- 1 = ^SRC DLY MSR (trigger starts source)
- 2 = SRC^DLY MSR (trigger starts delay)
- 3 = ^SRC^DLY MSR
- 4 = SRC DLY^MSR (trigger starts measure)
- 5 = ^SRC DLY^MSR
- 6 = SRC^DLY^MSR
- 7 = ^SRC^DLY^MSR
- 8 = ^Single Pulse

out — Output trigger generation:

- 0 = None during sweep
- 1 = SRC^DLY MSR (end of source)
- 2 = SRC DLY^MSR (end of delay)
- 3 = SRC^DLY^MSR
- 4 = SRC DLY MSR^ (end of measure)
- 5 = SRC^DLY MSR^
- 6 = SRC DLY^MSR^
- 7 = SRC^DLY^MSR^
- 8 = Pulse End^

end — Sweep End^ trigger out:

- 0 = Disabled
- 1 = Enabled

Status	
U0	Send model number and firmware revision
U1	Send error status word
U2	Send stored ASCII string ("D2" command string)
U3	Send machine status word
U4	Send measurement parameters
U5	Send compliance value
U6	Send suppression value
U7	Send calibration status word
U8	Send defined sweep size
U9	Send warning status word
U10	Send first sweep point in compliance
U11	Send sweep measure size

1100V Range Control	237 only
V0	Disable 1100V range
V1	Enable 1100V range

Default Delay	
W0	Disable default delay
W1	Enable default delay

Execute	
X	Execute commands

Terminator	
Y0	<CR><LF>
Y1	<LF><CR>
Y2	<CR>
Y3	<LF>
Y4	none

Suppress	
Z0	Disable suppression
Z1	Enable suppression

Table 14. Order of Command Execution

Order	Command	Description
1	M	Set the SRQ mask
2	C	Calibration sequence
3	F	Set source and function
4	O	Program local/remote sense
5	P	Select filter
6	Z	Program suppression
7	S	Set integration time
8	W	Enable/disable default delay
9	L	Program compliance
10	B	Program bias operation
11	Q	Create/append sweep list
12	A	Modify sweep list
13	T	Select trigger configuration
14	R	Enable/disable triggers
15	N	Select operate/standby mode
16	D	Display a user message
17	Y	Select terminator characters
18	K	Select EOI and hold-off on X
19	G	Select output data format
20	V	1100V Range Control
21	J	Execute self-tests
22	U	Request status
23	H	Send IEEE immediate trigger
24	X	Execute DDCs

DATA FORMATS

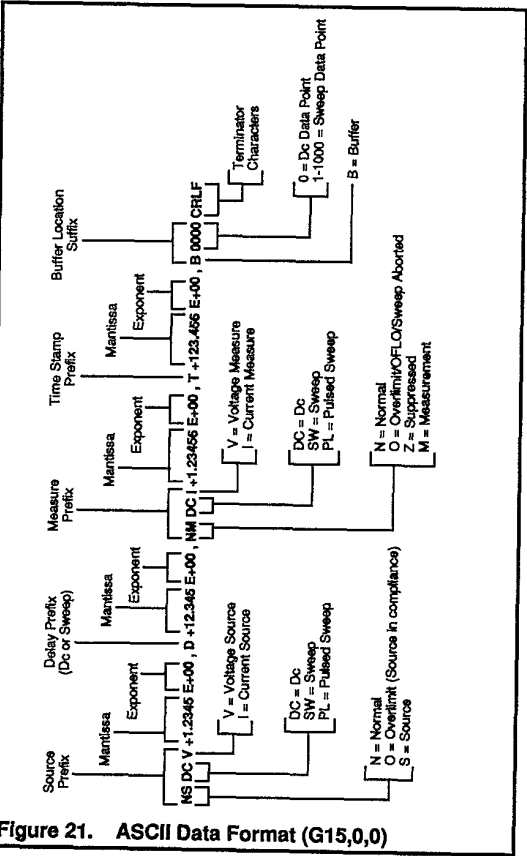
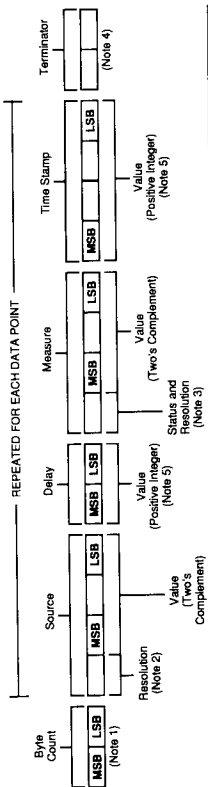

Figure 21. ASCII Data Format (G15,0,0)

HP BINARY DATA FORMAT



IBM BINARY DATA FORMAT

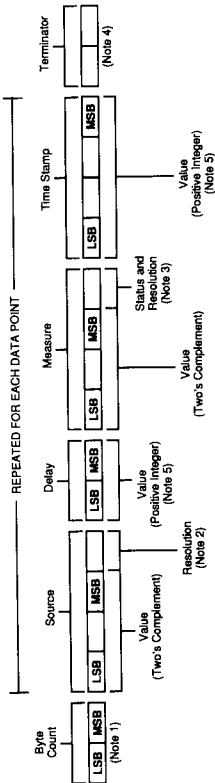

Figure 22. Binary Data Format (G15,3,0 and G15,4,0)

NOTES:

1. The byte count is the total number of bytes not including terminators.

2. Source Resolution:

0 =	E-14 amps	E-5 volts
1 =	E-13 amps	E-4 volts
2 =	E-12 amps	E-3 volts
3 =	E-11 amps	E-2 volts
4 =	E-10 amps	E-1 volts
5 =	E-9 amps	
6 =	E-8 amps	
7 =	E-7 amps	
8 =	E-6 amps	
9 =	E-5 amps	
10 =	E-4 amps	

3. Measure Status and Resolution:

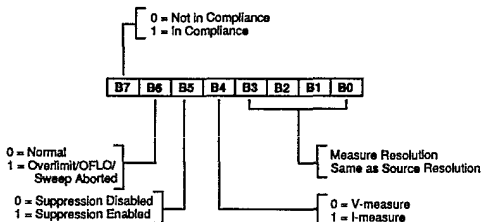

4. Terminator characters are selected with the Y command. They should not be used to terminate a binary transfer

5. Expressed as integer milliseconds.

Binary Data Format (G15,3,0 and G15,4,0) (Cont.)

SRQ MASK and SERIAL POLL BYTE

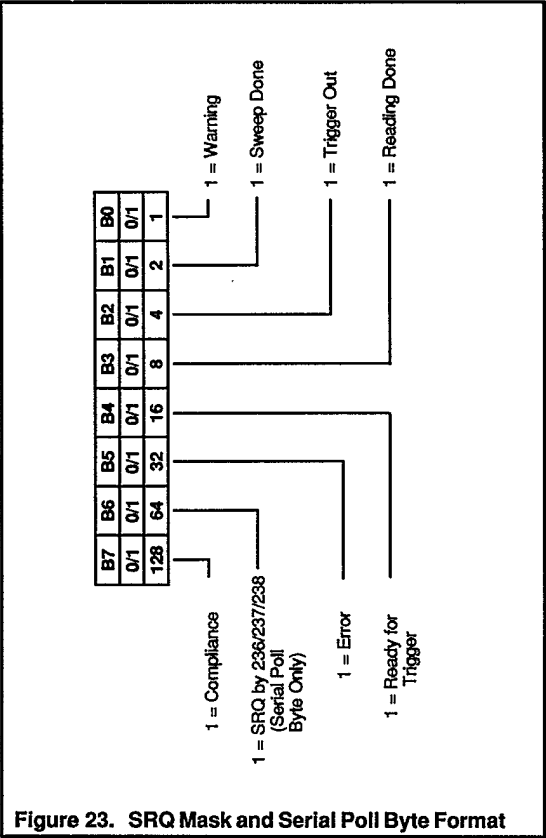
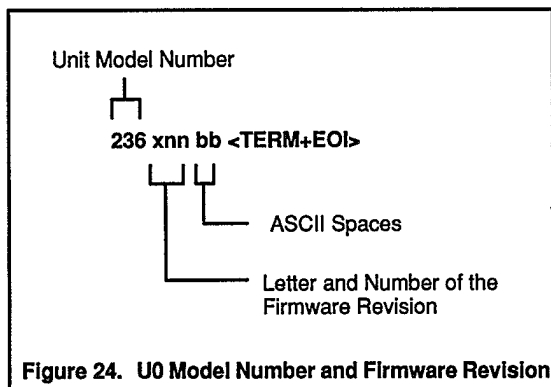
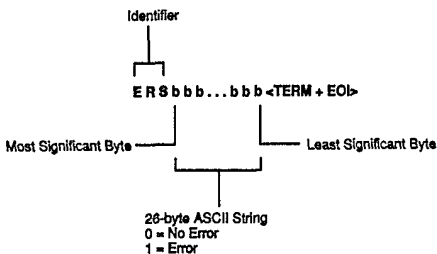

Figure 23. SRQ Mask and Serial Poll Byte Format

STATUS WORDS





Most Significant Byte	Trigger Overrun IDDC IDDCO Interlock Present Illegal Measure Range Illegal Source Range Invalid Sweep Mix Log Cannot Cross Zero Autoranging Source with Pulse Sweep In Calibration In Standby Unit is a 236
Least Significant Byte	IOU DPRAM Failed IOU EEROM Failed IOU Cal Checksum Error DPRAM Lockup DPRAM Link Error Cal ADC Zero Error Cal ADC Gain Error Cal SRC Zero Error Cal SRC Gain Error Cal Common Mode Error Cal Compliance Error Cal Value Error Cal Constants Error Cal Invalid Error

Figure 25. U1 Error Status Word

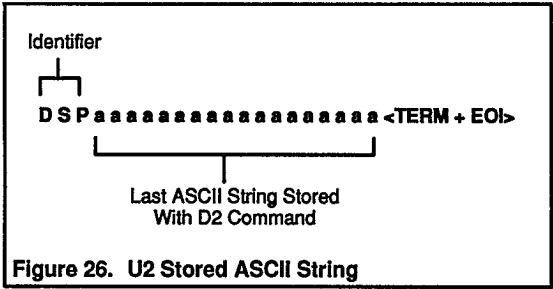

IDENTIFIER



MSTG01,0,0K0M000,0N0R1T4,0,0,0V1Y0 <TERM + EO!>

G — Output Data Format

Items (sum of bits)

- 00 = No items
- 01 = Source value
- 02 = Delay value
- 04 = Measure value
- 08 = Time value

Format

- 0 = ASCII, prefix and suffix
- 1 = ASCII, prefix no suffix
- 2 = ASCII, no prefix or suffix
- 3 = HP binary
- 4 = IBM binary

Lines

- 0 = One line from dc buffer
- 1 = One line front sweep buffer
- 2 = All lines from sweep buffer

K — EO! and Bus Hold-off

- 0 = Enable EO! and hold-off
- 1 = Disable EO!, enable hold-off
- 2 = Enable EO!, disable hold-off
- 3 = Disable EO! and hold-off

M — SRQ Mask and Compliance Select

Mask (sum of bits)

- 000 = Mask cleared
- 001 = Warning
- 002 = Sweep done
- 004 = Trigger out
- 008 = Reading done
- 016 = Ready for trigger
- 032 = Error
- 128 = Compliance

Compliance

- 0 = Delay, measure, or idle compliance
- 1 = Measurement compliance

N — Operate

- 0 = Standby
- 1 = Operate

R — Trigger Control

- 0 = Disable triggering
- 1 = Enable triggering

**Figure 27. U3 Machine Status Word
(Factory Default Conditions Shown)**

IDENTIFIER



MSTG01,0,0K0M000,0N0R1T4,0,0,0V1Y0 <TERM + EO!>

T — Trigger Configuration

Origin

- 0 = IEEE X
- 1 = IEEE GET
- 2 = IEEE talk
- 3 = External (TRIGGER IN pulse)
- 4 = Immediate trigger only

Trigger In

- 0 = Continuous
- 1 = ^SRC DLY MSR
- 2 = SRC^DLY MSR
- 3 = ^SRC^DLY MSR
- 4 = SRC DLY^MSR
- 5 = ^SRC DLY^MSR
- 6 = SRC^DLY^MSR
- 7 = ^SRC^DLY^MSR
- 8 = ^Single Pulse

Trigger Out

- 0 = None
- 1 = SRC^DLY MSR
- 2 = SRC DLY^MSR
- 3 = SRC^DLY^MSR
- 4 = SRC DLY MSR^
- 5 = SRC^DLY MSR^
- 6 = SRC DLY^MSR^
- 7 = SRC^DLY^MSR^
- 8 = Pulse End^

Sweep End^ Trigger Out

- 0 = Disabled
- 1 = Enabled

V — 1100V Range Control

- 0 = 1100V Range Disabled
- 1 = 1100V Range Enabled
(237 only)

Y = Terminator

- 0 = <CR><LF>
- 1 = <LF><CR>
- 2 = <CR>
- 3 = <LF>
- 4 = none

U3 Machine Status (Factory Default Conditions Shown) (Cont.)

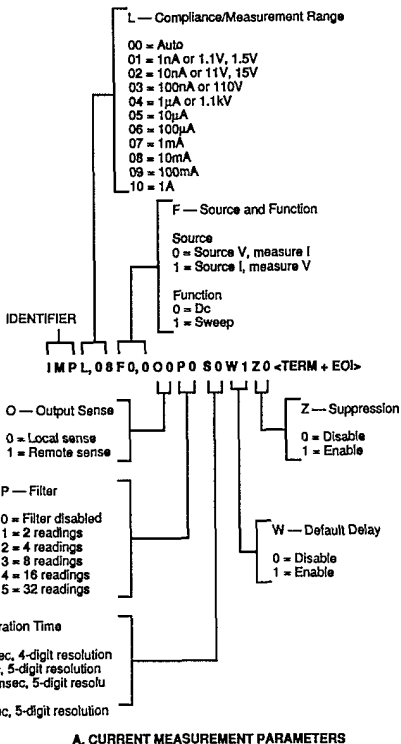

**Figure 28. U4 Measurement Parameters
(Factory Default Conditions Shown)**

L — Compliance/Measurement Range

Identifier

V M P L, 0 2 F 1, 0 0 0 P 0 S 0 W 1 Z 0 <TERM + EOb>

F — Source and Function

O — Output Sense

P — Filter

Z — Suppression

W — Default Delay

S — Integration Time

B. Voltage Measurement Parameters
(see Figure 28A for parameter descriptions)

U4 Measurement Parameters (Factory Default Conditions Shown) (Cont.)

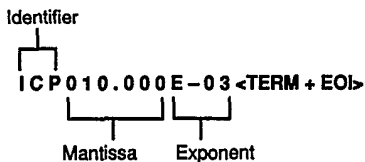

A. Compliance Value for Current Measurements

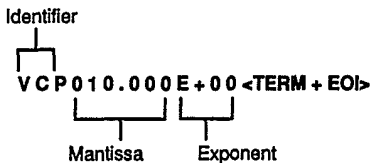

B. Compliance Value for Voltage Measurements

Figure 29. U5 Compliance Value (Factory Default Conditions Shown)

Identifier

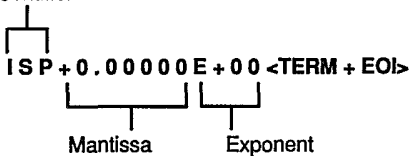

A. Suppression Value for Current Measurements

Identifier

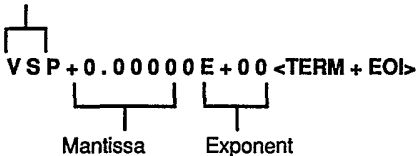

B. Suppression Value for Voltage Measurements

Figure 30. U6 Suppression Value (Factory Default Conditions Shown)

Identifier



C S P n n, a, b <TERM + EOI>



0 = Unit is Uncalibrated
1 = Unit is Calibrated



0 = Cal Lock Switch is Unlocked
1 = Cal Lock Switch is Locked
(Present Cal Constants Will
Not be Saved)



Calibration Step in Progress

Figure 31. U7 Calibration Status Word

Identifier



D S S n n n n <TERM + EOI>



Number of Source Values in
Sweep Buffer

Figure 32. U8 Defined Sweep Size

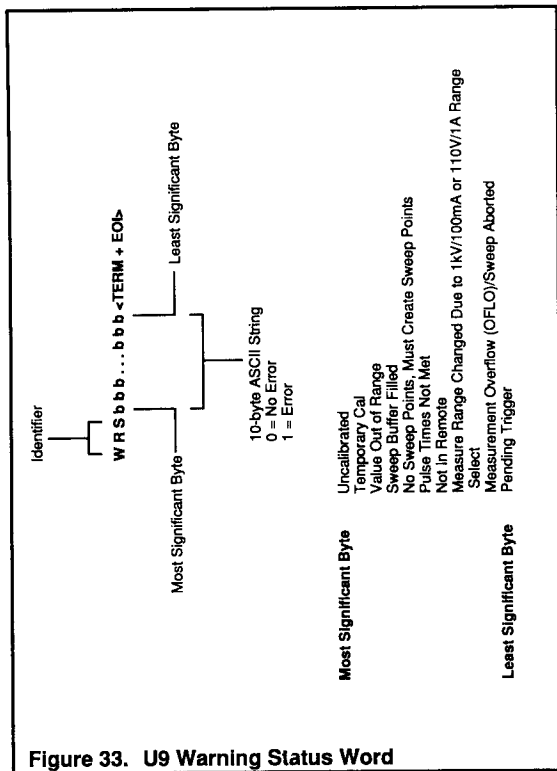

Figure 33. U9 Warning Status Word

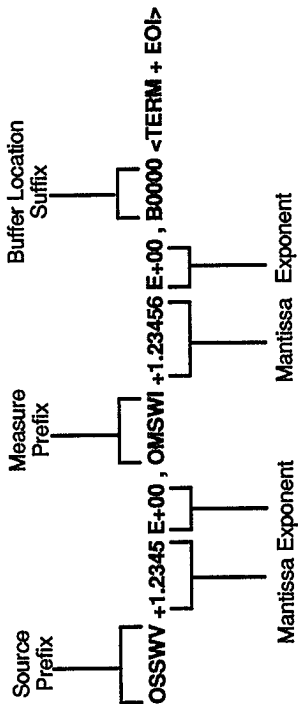

Figure 34. U10 First Sweep Point In Compliance

Identifier



S M S n n n n <TERM + EOI>



Number of Measure Values
in Sweep Buffer

Figure 35. U11 Sweep Measure Size

KEITHLEY

Keithley Instruments, Inc.
28775 Aurora Road
Cleveland, Ohio 44139

Printed in the U.S.A.