

# R&S® SMW200A

## Vector Signal Generator

### User Manual



1175663202  
Version 40

**ROHDE & SCHWARZ**  
Make ideas real



This document describes the R&S®SMW200A, stock no. 1412.0000.02 and the following options:

- R&S®SMW-B9/-B10
- R&S®SMW-B13/-B13T/-B13XT
- R&S®SMW-B20/-B22
- R&S®SMW-B81/-B82/-B83/-B84
- R&S®SMW-B90
- R&S®SMW-B1003/-B1006/-B1007/-B1012/-B1020/-B1031/-B1040/-B1044/-B1056/-B1067  
R&S®SMW-B1040N/-B1044N/-B1056N/-B1067N  
R&S®SMW-B1044O/-B1056O/-B1067O
- R&S®SMW-B2003/-B2006/-B2007/-B2012/-B2020/-B2031/-B2044  
R&S®SMW-B2044N  
R&S®SMW-B2044O
- R&S®SMW-B103/-B106/-B107/-B112/-B120/-B131/-B140/-B144  
R&S®SMW-B140N/-B144N  
R&S®SMW-B203/-B206/-B207/-B212/-B220
- R&S®SMW-B709/-B710/-B711  
R&S®SMW-B719/-B720/-B721
- R&S®SMW-K16/-K17/-K18/-K19
- R&S®SMW-K22/-K23/-K24
- R&S®SMW-K61/-K62
- R&S®SMW-K75/-K76
- R&S®SMW-K200
- R&S®SMW-K511/-K512/-K515/-K522/-K525/-K527
- R&S®SMW-K556
- R&S®SMW-K575
- R&S®SMW-K703/-K704/-K720/-K739
- R&S®SMW-K810/-K811
- R&S®SMW-K980

This manual describes firmware version FW 5.30.305.xx and later of the R&S®SMW200A.

© 2024 Rohde & Schwarz

Muehldorfstr. 15, 81671 Muenchen, Germany

Phone: +49 89 41 29 - 0

Email: [info@rohde-schwarz.com](mailto:info@rohde-schwarz.com)

Internet: [www.rohde-schwarz.com](http://www.rohde-schwarz.com)

Subject to change – data without tolerance limits is not binding.

R&S® is a registered trademark of Rohde & Schwarz GmbH & Co. KG.

The terms HDMI, HDMI High-Definition Multimedia Interface, HDMI trade dress and the HDMI Logos are trademarks or registered trademarks of HDMI Licensing Administrator, Inc.

MATLAB® is a registered trademark of The MathWorks, Inc.

All other trademarks are the properties of their respective owners.

1175.6632.02 | Version 40 | R&S®SMW200A

Throughout this document, R&S® is indicated as R&S.

# Contents

<b>1</b>	<b>Safety and regulatory information.....</b>	<b>19</b>
1.1	Safety instructions.....	19
1.2	Labels on R&S SMW200A.....	22
1.3	Warning messages in the documentation.....	22
1.4	CE declaration of conformity.....	23
1.5	Where to find key documents on Rohde & Schwarz.....	23
1.6	Korea certification class B.....	23
<b>2</b>	<b>Welcome to the R&amp;S SMW200A.....</b>	<b>24</b>
2.1	Key features.....	24
2.2	What's new.....	24
2.3	Documentation overview.....	25
2.3.1	Getting started manual.....	25
2.3.2	User manuals and help.....	25
2.3.3	Tutorials.....	25
2.3.4	Service manual.....	25
2.3.5	Instrument security procedures.....	26
2.3.6	Printed safety instructions.....	26
2.3.7	Specifications and product brochures.....	26
2.3.8	Calibration certificate.....	26
2.3.9	Release notes and open source acknowledgment.....	26
2.3.10	Application notes, application cards, white papers, etc.....	26
2.3.11	Videos.....	27
2.4	Scope and content.....	27
<b>3</b>	<b>Getting started.....</b>	<b>28</b>
3.1	Preparing for use.....	28
3.1.1	Lifting and carrying.....	28
3.1.2	Unpacking and checking.....	28
3.1.3	Choosing the operating site.....	28
3.1.4	Setting up the R&S SMW200A.....	29
3.1.5	Considerations for test setup.....	31
3.1.6	Connecting to power.....	32

3.1.7	Connecting to LAN.....	32
3.1.8	Connecting USB devices.....	33
3.1.9	Connecting to RF coaxial connectors.....	34
3.1.10	Connecting to RF A/RF B.....	35
3.1.11	Connecting to LO In/Out.....	36
3.1.12	Connecting to REF IN/REF OUT.....	36
3.1.13	Connecting to HS DIG I/Q.....	36
3.1.14	Switching on or off.....	37
<b>3.2</b>	<b>Instrument tour.....</b>	<b>38</b>
3.2.1	Front panel tour.....	39
3.2.2	Rear panel tour.....	45
<b>3.3</b>	<b>Trying out the instrument.....</b>	<b>53</b>
3.3.1	Generating an unmodulated carrier.....	54
3.3.2	Generating a digitally modulated signal.....	56
3.3.3	Triggering the instrument externally.....	57
3.3.4	Working with marker signals.....	62
3.3.5	Routing a baseband signal to the outputs.....	63
3.3.6	Visualizing the generated signal.....	67
3.3.7	Saving and recalling settings.....	70
3.3.8	Generating an EUTRA/LTE signal.....	72
3.3.9	Enabling MIMO configuration.....	75
<b>3.4</b>	<b>System overview.....</b>	<b>78</b>
3.4.1	Brief concept of the instrument.....	79
3.4.2	Applications examples of the R&S SMW200A.....	82
<b>3.5</b>	<b>Operating the instrument.....</b>	<b>86</b>
3.5.1	Means of manual interaction.....	87
3.5.2	Understanding the display information.....	88
3.5.3	Accessing the functionality.....	93
3.5.4	Entering data.....	94
3.5.5	Undo and redo actions.....	95
3.5.6	Getting information and help.....	95
<b>4</b>	<b>Signal routing and system configuration.....</b>	<b>100</b>
4.1	Working with the system configuration function.....	100

4.1.1	Configuring the system for your test case.....	101
4.1.2	Test scenario and required system configuration.....	102
<b>4.2</b>	<b>Possible ways to configure the signal flow.....</b>	<b>105</b>
4.2.1	Using the signal routing settings and the block diagram.....	105
4.2.2	Using the system configuration capabilities.....	106
<b>4.3</b>	<b>Overview of the signals and interfaces.....</b>	<b>108</b>
4.3.1	Physical location of the input and output interfaces.....	109
4.3.2	Overview of the baseband signal sources.....	111
4.3.3	Overview of the baseband and RF output signals.....	112
4.3.4	Supported digital interfaces and system configuration.....	113
4.3.5	Important signal parameters and interface characteristics.....	114
<b>4.4</b>	<b>System configuration settings.....</b>	<b>118</b>
4.4.1	Fading and baseband configuration settings.....	119
4.4.2	I/Q stream mapper settings.....	127
4.4.3	External RF and I/Q settings.....	129
4.4.4	External instrument configuration settings.....	136
4.4.5	Overview.....	145
<b>4.5</b>	<b>Signal routing settings.....</b>	<b>147</b>
<b>4.6</b>	<b>Digital baseband input settings.....</b>	<b>151</b>
4.6.1	Baseband input settings in the standard baseband generator.....	151
4.6.2	Baseband input settings in the wideband baseband generator.....	158
<b>4.7</b>	<b>I/Q digital output settings.....</b>	<b>164</b>
4.7.1	General settings.....	167
4.7.2	Channels settings.....	170
4.7.3	Signal output settings.....	172
<b>4.8</b>	<b>I/Q analog output settings.....</b>	<b>176</b>
4.8.1	General analog I/Q output settings.....	178
<b>4.9</b>	<b>How to connect external instruments and configure the signal flow.....</b>	<b>182</b>
4.9.1	Finding out the suitable configuration for your test situation.....	183
4.9.2	How to find out where the input/output interface is located.....	184
4.9.3	How to define the MIMO scenario.....	185
4.9.4	How to route the I/Q streams to the output interfaces.....	187
4.9.5	How to cable the instruments in MIMO test setups.....	188

4.9.6	How to connect and configure external instruments.....	189
4.9.7	Connecting to HS DIG I/Q interfaces.....	197
4.9.8	How to generate a 2x8 MIMO signal for BS tests.....	203
4.9.9	How to generate a 8x8 MIMO signal with two R&S SMW200A.....	204
4.9.10	How to connect an R&S®CMW500 for fading applications.....	208
4.9.11	How to apply an external digital baseband signal.....	210
4.9.12	How to connect an R&S EX-IQ-BOX.....	212
<b>5</b>	<b>Configuring the internal baseband source.....</b>	<b>215</b>
<b>5.1</b>	<b>Overview of the signal generation modes.....</b>	<b>215</b>
<b>5.2</b>	<b>Standard or wideband baseband generator.....</b>	<b>216</b>
<b>5.3</b>	<b>Accessing the functions in the baseband domain.....</b>	<b>218</b>
<b>5.4</b>	<b>Generating signals according to digital standards.....</b>	<b>219</b>
<b>5.5</b>	<b>Common characteristics of the baseband domain.....</b>	<b>223</b>
5.5.1	About common baseband characteristics.....	224
5.5.2	Common baseband settings.....	251
5.5.3	Triggering with a common signal.....	261
5.5.4	Time-based triggering.....	263
<b>5.6</b>	<b>Generating custom digital modulation signals.....</b>	<b>266</b>
5.6.1	Required options.....	267
5.6.2	About custom digital modulation.....	267
5.6.3	Custom digital modulation settings.....	267
5.6.4	Creating data and control lists.....	288
5.6.5	References.....	291
<b>5.7</b>	<b>Using the arbitrary waveform generator (ARB).....</b>	<b>302</b>
5.7.1	Required options.....	303
5.7.2	About ARB.....	303
5.7.3	ARB settings.....	309
5.7.4	Playing waveform files.....	319
5.7.5	Tags for waveforms, data and control lists.....	335
<b>5.8</b>	<b>Generating notched signals.....</b>	<b>353</b>
5.8.1	Required options.....	353
5.8.2	About the notch filters.....	354
5.8.3	Notch filter settings.....	354

5.8.4	AWGN test signal settings.....	358
<b>5.9</b>	<b>Reducing the crest factor.....</b>	<b>360</b>
<b>5.10</b>	<b>Generating multi-segment waveform files.....</b>	<b>360</b>
5.10.1	Required options.....	360
5.10.2	About the multi-segment waveforms.....	360
5.10.3	Multi-segment settings.....	366
5.10.4	Working with multi-segment waveform files.....	382
5.10.5	Reference to triggering of multi-segment waveforms.....	388
<b>5.11</b>	<b>Generating multicarrier waveform signals.....</b>	<b>391</b>
5.11.1	Required options.....	391
5.11.2	About the multicarrier waveforms.....	391
5.11.3	Multicarrier settings.....	393
5.11.4	Using the multicarrier function.....	406
<b>5.12</b>	<b>Generating multicarrier continuous wave signals.....</b>	<b>408</b>
5.12.1	Required options.....	409
5.12.2	About MCCW.....	409
5.12.3	MCCW settings.....	409
5.12.4	Using MCCW signals.....	415
5.12.5	References.....	417
<b>5.13</b>	<b>Generating a linear slope ramp waveform.....</b>	<b>418</b>
<b>5.14</b>	<b>Shifting the baseband signal.....</b>	<b>418</b>
5.14.1	About baseband offsets.....	418
5.14.2	Baseband offset settings.....	421
5.14.3	Improving signal characteristics by shifting the baseband signal.....	422
<b>6</b>	<b>Fading, predistorting and impairing the signal.....</b>	<b>424</b>
<b>6.1</b>	<b>Simulating fading.....</b>	<b>424</b>
<b>6.2</b>	<b>Adding noise to the signal.....</b>	<b>424</b>
6.2.1	Required options.....	424
6.2.2	About the AWGN generator.....	425
6.2.3	AWGN block.....	431
6.2.4	AWGN settings.....	431
6.2.5	How to configure the noise generator for receiver tests.....	440
<b>6.3</b>	<b>Generating impulsive and phase noise.....</b>	<b>442</b>

6.3.1	Required options.....	442
6.3.2	About the impulsive noise.....	442
6.3.3	About the phase noise.....	443
6.3.4	Impulsive noise settings.....	444
6.3.5	Phase noise settings.....	447
<b>6.4</b>	<b>Impairing the signal.....</b>	<b>449</b>
6.4.1	Required options.....	449
6.4.2	About the linear I/Q impairments.....	449
6.4.3	Analog and digital impairments settings.....	452
6.4.4	Optimizing carrier leakage and sideband suppression.....	456
<b>6.5</b>	<b>Frequency response correction.....</b>	<b>457</b>
<b>6.6</b>	<b>Applying digital predistortion.....</b>	<b>457</b>
<b>7</b>	<b>Applying I/Q vector modulation.....</b>	<b>458</b>
<b>7.1</b>	<b>Required options.....</b>	<b>458</b>
<b>7.2</b>	<b>About the I/Q modulator.....</b>	<b>458</b>
7.2.1	Input signals of the I/Q modulator.....	459
7.2.2	About I/Q modulation optimizations.....	459
<b>7.3</b>	<b>Optimizing I/Q modulation performance.....</b>	<b>460</b>
7.3.1	General I/Q modulation tasks.....	460
7.3.2	Using optimization characteristics.....	461
7.3.3	Improving the output signal quality.....	465
<b>7.4</b>	<b>I/Q modulator settings.....</b>	<b>466</b>
7.4.1	General settings.....	467
7.4.2	Optimizations settings.....	471
<b>8</b>	<b>Configuring the RF signal.....</b>	<b>475</b>
<b>8.1</b>	<b>Required options.....</b>	<b>476</b>
<b>8.2</b>	<b>How to access the RF settings.....</b>	<b>476</b>
<b>8.3</b>	<b>How to activate RF signal output.....</b>	<b>478</b>
<b>8.4</b>	<b>How to set the frequency and level.....</b>	<b>479</b>
8.4.1	References.....	480
<b>8.5</b>	<b>RF frequency settings.....</b>	<b>481</b>
<b>8.6</b>	<b>RF level settings.....</b>	<b>485</b>
<b>8.7</b>	<b>RF phase settings.....</b>	<b>490</b>



<b>8.8 Reference oscillator.....</b>	<b>491</b>
8.8.1 Required options.....	491
8.8.2 Reference frequency settings.....	491
8.8.3 Reference output settings.....	495
8.8.4 Adjustment settings.....	496
8.8.5 Using the reference frequency for instruments synchronization.....	497
<b>8.9 Local oscillator coupling.....</b>	<b>500</b>
8.9.1 Required options.....	501
8.9.2 Phase coherence.....	501
8.9.3 LO coupling settings.....	502
8.9.4 Configuring cascaded instruments.....	504
<b>8.10 Varying the RF signal in list or sweep mode.....</b>	<b>509</b>
8.10.1 Signal generation and triggering in the sweep and list modes.....	511
8.10.2 About sweep mode.....	518
8.10.3 About list mode.....	522
8.10.4 Significant parameters and functions.....	523
8.10.5 Sweep mode settings.....	525
8.10.6 List mode settings.....	535
8.10.7 List data editor.....	542
8.10.8 How to generate a signal in list or sweep mode.....	544
<b>8.11 Analog modulations.....</b>	<b>546</b>
8.11.1 Required options.....	548
8.11.2 Modulation signals.....	549
8.11.3 Activating analog modulations.....	556
8.11.4 Modulation settings.....	557
8.11.5 How to generate a modulated signal.....	579
<b>8.12 Improving level performance.....</b>	<b>580</b>
8.12.1 Attenuator.....	581
8.12.2 ALC - automatic level control.....	584
8.12.3 User correction.....	588
8.12.4 Using power sensors.....	600
8.12.5 Improving the RF signal performance.....	617
<b>9 Monitoring signal characteristics.....</b>	<b>622</b>

<b>9.1</b>	<b>Monitoring baseband signal characteristics.....</b>	<b>622</b>
9.1.1	Required options.....	622
9.1.2	About the graphical signal display.....	622
9.1.3	Graphics configuration settings.....	630
9.1.4	Graphical signal display settings.....	633
9.1.5	Checking the generated signal graphically.....	635
<b>9.2</b>	<b>Querying baseband power levels.....</b>	<b>645</b>
9.2.1	Required options.....	645
9.2.2	About leveling.....	645
9.2.3	Baseband power settings.....	650
9.2.4	Measuring baseband power levels.....	654
<b>10</b>	<b>Multi-instrument setups.....</b>	<b>663</b>
<b>10.1</b>	<b>Synchronizing instruments.....</b>	<b>663</b>
<b>10.2</b>	<b>Generating phase coherent signals.....</b>	<b>663</b>
<b>10.3</b>	<b>Generating time-aligned baseband signals.....</b>	<b>664</b>
10.3.1	Connecting multiple instruments in primary-secondary instrument mode.....	664
10.3.2	Connecting to HS DIG I/Q interfaces.....	672
10.3.3	Triggering several instruments with a common trigger signal.....	678
<b>10.4</b>	<b>Generating phase-coherent signals.....</b>	<b>679</b>
10.4.1	Required options.....	680
10.4.2	RF ports alignment configuration and settings.....	680
<b>10.5</b>	<b>Control and operation of external instruments.....</b>	<b>696</b>
10.5.1	Prerequisites for control of external instruments from the R&S SMW200A.....	696
10.5.2	Test setups.....	696
10.5.3	Control of connected R&S SGT.....	697
10.5.4	Control of connected R&S SZU.....	697
10.5.5	Further information.....	697
<b>11</b>	<b>File and data management.....</b>	<b>699</b>
<b>11.1</b>	<b>About the file system.....</b>	<b>699</b>
<b>11.2</b>	<b>Restoring an instrument configuration.....</b>	<b>702</b>
11.2.1	Preset, set to default and factory preset settings.....	704
11.2.2	Identifying parameters with non-default values.....	705
11.2.3	Presetting the instrument to a user-defined state.....	706

11.2.4	Reference.....	706
<b>11.3</b>	<b>Protecting data.....</b>	<b>707</b>
<b>11.4</b>	<b>Saving and recalling settings.....</b>	<b>708</b>
11.4.1	Save/Recall settings.....	709
11.4.2	Saving and recalling instrument settings.....	712
11.4.3	Recalling firmware option settings.....	713
<b>11.5</b>	<b>Accessing files with user data.....</b>	<b>714</b>
11.5.1	File select settings.....	714
11.5.2	Creating data lists and control lists.....	717
<b>11.6</b>	<b>Exporting and importing remote command lists.....</b>	<b>718</b>
<b>11.7</b>	<b>Loading, importing and exporting lists.....</b>	<b>718</b>
<b>11.8</b>	<b>Using the file manager.....</b>	<b>719</b>
11.8.1	File manager settings.....	719
11.8.2	Map network share settings.....	721
11.8.3	Displaying all saved files.....	723
11.8.4	Mapping a network folder.....	723
<b>11.9</b>	<b>Transferring files from and to the instrument.....</b>	<b>725</b>
11.9.1	Removing file system protection.....	725
11.9.2	Accessing the file system using FTP.....	726
11.9.3	Accessing the R&S SMW200A file system using SMB (Samba).....	728
11.9.4	Using a USB storage device for file transfer.....	729
11.9.5	Using a file server for test files exchange.....	730
<b>11.10</b>	<b>Creating screenshots of current settings.....</b>	<b>731</b>
11.10.1	Hardcopy settings.....	731
11.10.2	Creating a hardcopy of the display.....	734
<b>12</b>	<b>General instrument functions.....</b>	<b>736</b>
<b>12.1</b>	<b>Customizing the user interface.....</b>	<b>736</b>
12.1.1	Display and keyboard settings.....	737
12.1.2	Appearance settings.....	739
12.1.3	Display update settings.....	739
12.1.4	Defining the RF signal state on power on.....	740
12.1.5	How to set the initial instrument settings.....	741
<b>12.2</b>	<b>Configuring local and global connectors.....</b>	<b>742</b>

12.2.1	Required options.....	743
12.2.2	About local and global connectors.....	743
12.2.3	Trigger marker clock settings.....	748
12.2.4	RF connectors settings.....	751
12.2.5	Global connectors settings.....	752
12.2.6	Local connectors settings.....	757
12.2.7	Routing signals to the connectors.....	760
<b>12.3</b>	<b>Checking parameters and dependencies.....</b>	<b>761</b>
<b>12.4</b>	<b>Organizing frequently used settings as favorites.....</b>	<b>763</b>
12.4.1	Configuring settings quickly with the user menu.....	765
12.4.2	How to assign actions to the [USER] key.....	767
12.4.3	User menu settings.....	768
12.4.4	Define user key actions settings.....	769
<b>12.5</b>	<b>Managing licenses and license keys.....</b>	<b>770</b>
12.5.1	Manage license keys settings.....	773
12.5.2	Using the license server.....	780
12.5.3	How to occupy or extend a license.....	789
12.5.4	How to move a portable license.....	791
<b>12.6</b>	<b>Managing extensions.....</b>	<b>792</b>
12.6.1	Manage extension settings.....	793
12.6.2	How to install or deinstall an extension.....	793
<b>12.7</b>	<b>Using the security settings.....</b>	<b>794</b>
12.7.1	Disk & memory security settings.....	795
12.7.2	Manual operation security settings.....	797
12.7.3	Protection level settings.....	799
12.7.4	Configuring LAN services.....	800
12.7.5	Password management.....	804
12.7.6	Preventing unauthorized access.....	806
<b>12.8</b>	<b>Undoing or restoring actions.....</b>	<b>810</b>
<b>12.9</b>	<b>Shutting down and rebooting the instrument.....</b>	<b>811</b>
<b>12.10</b>	<b>Reference.....</b>	<b>812</b>
<b>13</b>	<b>Network operation and remote control.....</b>	<b>816</b>
13.1	Overview of remote access modes.....	817

<b>13.2 Remote control interfaces and protocols.....</b>	<b>818</b>
13.2.1 LAN interface.....	819
13.2.2 USB interface.....	821
13.2.3 GPIB interface (IEC/IEEE bus interface).....	822
13.2.4 LXI browser interface.....	822
<b>13.3 Remote control programs and libraries.....</b>	<b>823</b>
<b>13.4 Status reporting system.....</b>	<b>826</b>
13.4.1 Overview of the status registers.....	826
13.4.2 Instrument-specific status operation register.....	828
13.4.3 Instrument-specific status questionable register.....	828
13.4.4 Reset values of the status reporting system.....	829
<b>13.5 Remote access settings.....</b>	<b>829</b>
13.5.1 Network settings.....	830
13.5.2 VISA resource strings settings.....	833
13.5.3 GPIB address settings.....	834
13.5.4 RS232 settings.....	835
13.5.5 Instrument emulations settings.....	836
13.5.6 Active remote connection settings.....	838
13.5.7 Closed remote connection settings.....	839
13.5.8 HUMS settings.....	840
13.5.9 HUMS enhanced settings.....	843
13.5.10 QR code.....	851
<b>13.6 LXI status settings.....</b>	<b>851</b>
<b>13.7 LXI browser settings.....</b>	<b>853</b>
13.7.1 LAN configuration.....	855
13.7.2 SCPI remote trace.....	857
13.7.3 Health and utilization.....	859
13.7.4 Datasheet.....	859
<b>13.8 Setting up remote control.....</b>	<b>860</b>
13.8.1 Configuring remote access.....	861
13.8.2 Starting remote control with LXI.....	864
13.8.3 Starting remote control with VXI-11.....	865
13.8.4 Starting remote control with socket communication.....	870

13.8.5	Starting remote control over GPIB.....	871
13.8.6	Starting remote control over USB.....	872
13.8.7	Stopping remote control.....	872
<b>13.9</b>	<b>Using remote command scripts.....</b>	<b>874</b>
13.9.1	SCPI recording settings.....	874
13.9.2	Creating remote command lists.....	878
13.9.3	Checking and verifying a remote command list.....	881
13.9.4	Converting a remote command list to a script.....	882
13.9.5	Running a remote command script.....	884
<b>13.10</b>	<b>Setting up remote operation over VNC.....</b>	<b>884</b>
13.10.1	Using a controller PC.....	885
13.10.2	Using a smart device.....	888
13.10.3	Stopping remote operation.....	890
<b>13.11</b>	<b>References.....</b>	<b>891</b>
13.11.1	LXI functionality.....	891
13.11.2	Code generator templates.....	891
<b>14</b>	<b>Remote control commands.....</b>	<b>894</b>
<b>14.1</b>	<b>Conventions used in SCPI command descriptions.....</b>	<b>894</b>
<b>14.2</b>	<b>Backward compatibility with other Rohde &amp; Schwarz signal generators.....</b>	<b>895</b>
<b>14.3</b>	<b>SCPI command aliases for advanced mode with multiple entities.....</b>	<b>896</b>
<b>14.4</b>	<b>Programming examples.....</b>	<b>898</b>
<b>14.5</b>	<b>Common commands.....</b>	<b>898</b>
<b>14.6</b>	<b>Preset commands.....</b>	<b>903</b>
<b>14.7</b>	<b>MMEMory subsystem.....</b>	<b>904</b>
14.7.1	File naming conventions.....	905
14.7.2	Handling files in the default or in a specified directory.....	906
14.7.3	Programming examples.....	907
14.7.4	Remote control commands.....	909
<b>14.8</b>	<b>CALibration subsystem.....</b>	<b>917</b>
<b>14.9</b>	<b>CLOCK subsystem.....</b>	<b>922</b>
<b>14.10</b>	<b>DIAGnostic subsystem.....</b>	<b>923</b>
<b>14.11</b>	<b>HUMS remote control commands.....</b>	<b>926</b>
<b>14.12</b>	<b>DISPlay subsystem.....</b>	<b>933</b>

<b>14.13</b>	<b>FORMat subsystem</b> .....	<b>937</b>
<b>14.14</b>	<b>HCOPy subsystem</b> .....	<b>939</b>
14.14.1	Hard copy settings.....	940
14.14.2	Automatic naming.....	941
<b>14.15</b>	<b>KBOard subsystem</b> .....	<b>944</b>
<b>14.16</b>	<b>OUTPut subsystem</b> .....	<b>945</b>
<b>14.17</b>	<b>SENSE, READ, INITiate and SLISt subsystems</b> .....	<b>948</b>
<b>14.18</b>	<b>SCONfiguration subsystem</b> .....	<b>963</b>
14.18.1	Multi-instrument configuration commands.....	973
14.18.2	Baseband and fading configuration commands.....	974
14.18.3	I/Q stream mapper commands.....	980
14.18.4	External RF and I/Q instruments commands.....	982
14.18.5	RF ports alignment commands.....	996
<b>14.19</b>	<b>SOURce subsystem</b> .....	<b>1005</b>
14.19.1	Connector settings.....	1006
14.19.2	SOURce:AWGN subsystem.....	1016
14.19.3	SOURce:BBIN subsystem.....	1026
14.19.4	Analog modulation subsystems.....	1036
14.19.5	SOURce:BB subsystem.....	1056
14.19.6	SOURce:CORRection subsystem.....	1185
14.19.7	SOURce:FREQuency subsystem.....	1197
14.19.8	SOURce:FREQuency:CONVerter subsystem.....	1206
14.19.9	SOURce:INPut subsystem.....	1208
14.19.10	SOURce:IQ subsystem.....	1209
14.19.11	SOURce:IQ:OUTPut subsystem.....	1212
14.19.12	SOURce:LFOutput subsystem.....	1227
14.19.13	SOURce:LIST subsystem.....	1240
14.19.14	SOURce:NOISe subsystem.....	1254
14.19.15	SOURce:OCCupy subsystem.....	1260
14.19.16	SOURce:PGEN subsystem.....	1262
14.19.17	SOURce:PHASe subsystem.....	1263
14.19.18	SOURce:POWer subsystem.....	1264
14.19.19	SOURce:ROSCillator subsystem.....	1280

14.19.20	RF ports alignment commands.....	1285
14.19.21	SOURce:SWEEp subsystem.....	1287
<b>14.20</b>	<b>SYSTem subsystem.....</b>	<b>1295</b>
<b>14.21</b>	<b>STATus subsystem.....</b>	<b>1326</b>
<b>14.22</b>	<b>TEST subsystem.....</b>	<b>1330</b>
<b>14.23</b>	<b>TRIGger subsystem.....</b>	<b>1337</b>
<b>14.24</b>	<b>UNIT subsystem.....</b>	<b>1339</b>
<b>15</b>	<b>Troubleshooting and notifications.....</b>	<b>1341</b>
<b>15.1</b>	<b>Notifications.....</b>	<b>1341</b>
15.1.1	Volatile notifications.....	1341
15.1.2	Permanent notifications.....	1342
<b>15.2</b>	<b>SCPI notifications.....</b>	<b>1342</b>
<b>15.3</b>	<b>Device-specific notifications.....</b>	<b>1342</b>
<b>15.4</b>	<b>Querying notifications.....</b>	<b>1344</b>
<b>15.5</b>	<b>Resolving network connection failures.....</b>	<b>1345</b>
<b>15.6</b>	<b>Resolving errors during internal adjustments.....</b>	<b>1346</b>
<b>15.7</b>	<b>Measuring USB cable quality.....</b>	<b>1347</b>
<b>15.8</b>	<b>Checking the instrument configuration.....</b>	<b>1347</b>
15.8.1	Hardware configuration settings.....	1350
15.8.2	Versions and options settings.....	1351
<b>15.9</b>	<b>Collecting information for technical support.....</b>	<b>1353</b>
<b>15.10</b>	<b>Contacting customer support.....</b>	<b>1354</b>
<b>16</b>	<b>Transporting.....</b>	<b>1356</b>
<b>17</b>	<b>Maintenance, storage and disposal.....</b>	<b>1357</b>
<b>17.1</b>	<b>Cleaning.....</b>	<b>1357</b>
<b>17.2</b>	<b>Storage.....</b>	<b>1357</b>
<b>17.3</b>	<b>Performing maintenance tasks.....</b>	<b>1357</b>
17.3.1	Date and time.....	1358
17.3.2	Check front panel.....	1360
17.3.3	Check display screen.....	1366
17.3.4	Internal adjustments.....	1367
17.3.5	Selftest.....	1372



17.3.6	FPGA/uC update settings.....	1376
17.3.7	Exchanging the RF adapter port.....	1377
17.4	<b>Disposal.....</b>	<b>1377</b>
	<b>Annex.....</b>	<b>1378</b>
A	<b>Available user files and file extensions.....</b>	<b>1378</b>
B	<b>Unit shortcuts.....</b>	<b>1381</b>
C	<b>Naming conventions in the user interface.....</b>	<b>1383</b>
D	<b>ARB file formats CSV and MAT.....</b>	<b>1386</b>
E	<b>Available tutorial files.....</b>	<b>1389</b>
F	<b>Reference information for remote control.....</b>	<b>1390</b>
F.1	Telnet program examples.....	1390
F.2	GPIB interface.....	1395
G	<b>RF hardware versions.....</b>	<b>1397</b>
G.1	RF assemblies and options.....	1397
G.2	Affected parameters and settings.....	1398
	<b>Glossary: Terms and abbreviations.....</b>	<b>1399</b>
	<b>Glossary: Publications and references.....</b>	<b>1406</b>
	<b>List of commands and waveform tags.....</b>	<b>1409</b>
	<b>Index.....</b>	<b>1435</b>



# 1 Safety and regulatory information

The product documentation helps you use the product safely and efficiently. Follow the instructions provided here and in the following sections.

## Intended use

The product generates radio frequency (RF) signals for the development, production and verification of electronic components, modules or devices. The product is intended for industrial use, for example for production and conformance testing, maintenance and engineering laboratories.

Use the product only for its designated purpose. Any other use is considered improper use. Observe the operating conditions and performance limits stated in the specifications document.

## Target audience

This document targets at all users, including technicians, operators, administrators and maintenance personnel. The required skills and experience of the users depend on the test setup and application of the product.

## Where do I find safety information?

Safety information is part of the product documentation. It warns you of potential dangers and gives instructions on how to prevent personal injury or damage caused by dangerous situations. Safety information is provided as follows:

- In [Section 1.1, "Safety instructions"](#), on page 19. The same information is provided in many languages in printed format. The printed "Safety Instructions" for "Mains-Powered Products, Heavy" (document number 1171.1788.99) are delivered with the product.
- Throughout the documentation, safety instructions are provided when you need to take care during setup or operation.

## 1.1 Safety instructions

Products from the Rohde & Schwarz group of companies are manufactured according to the highest technical standards. To use the products safely, follow the instructions provided here and in the product documentation. Keep the product documentation nearby and offer it to other users.

Use the product only for its intended use and within its performance limits. Intended use and limits are described in the product documentation such as the specifications document, manuals and the printed "Safety Instructions" document. If you are unsure about the appropriate use, contact Rohde & Schwarz customer support.

Using the product requires specialists or specially trained personnel. These users also need sound knowledge of at least one of the languages in which the user interfaces and the product documentation are available.

Reconfigure or adjust the product only as described in the product documentation or the specifications document. Any other modifications can affect safety and are not permitted.

Never open the casing of the product. Only service personnel authorized by Rohde & Schwarz are allowed to repair the product. If any part of the product is damaged or broken, stop using the product. Contact Rohde & Schwarz customer support at <https://www.rohde-schwarz.com/support>.

### **Lifting and carrying the product**

The product is heavy. Do not move or carry the product by yourself. A single person can only carry a maximum of 18 kg safely depending on age, gender and physical condition. Look up the maximum weight in the specifications document. Use the product handles to move or carry the product. Do not lift by the accessories mounted on the product. Accessories are not designed to carry the weight of the product.

To move the product safely, you can use lifting or transporting equipment such as lift trucks and forklifts. Follow the instructions provided by the equipment manufacturer.

### **Choosing the operating site**

Only use the product indoors. The product casing is not waterproof. Water that enters can electrically connect the casing with live parts, which can lead to electric shock, serious personal injury or death if you touch the casing.

If Rohde & Schwarz provides accessories designed for outdoor use of your product, e.g. a protective cover, you can use the product outdoors.

You can operate the product up to an altitude of 2000 m above sea level. If a higher altitude is permissible, the value is provided in the specifications document. The product is suitable for pollution degree 2 environments where nonconductive contamination can occur. For more information on environmental conditions such as ambient temperature and humidity, see the specifications document.

### **Setting up the product**

Always place the product on a stable, flat and level surface with the bottom of the product facing down. If the product is designed for different positions, secure the product so that it cannot fall over.

If the product has foldable feet, always fold the feet completely in or out to ensure stability. The feet can collapse if they are not folded out completely or if the product is moved without lifting it. The foldable feet are designed to carry the weight of the product, but not an extra load.

If stacking is possible, keep in mind that a stack of products can fall over and cause injury.

If you mount products in a rack, ensure that the rack has sufficient load capacity and stability. Observe the specifications of the rack manufacturer. Always install the products from the bottom shelf to the top shelf so that the rack stands securely. Secure the product so that it cannot fall off the rack.

### Connecting the product

Before connecting the interfaces or measuring inputs of the product to other products or electrical circuits, make sure that the other products or electrical circuits provide special protection against electric shock. This protection principle is referred to as SELV (safety extra-low voltage) and is based on a low voltage level and increased insulation. Exceptions are indicated by a measurement category on the product and given in the specifications document.

### Connecting to power

The product is an overvoltage category II product. Connect the product to a fixed installation used to supply energy-consuming equipment such as household appliances and similar loads. Keep in mind that electrically powered products have risks, such as electric shock, fire, personal injury or even death. Replace parts that are relevant to safety only by original parts, e.g. power cables or fuses.

Take the following measures for your safety:



- Before switching on the product, ensure that the voltage and frequency indicated on the product match the available power source. If the power adapter does not adjust automatically, set the correct value and check the rating of the fuse.
- Only use the power cable delivered with the product. It complies with country-specific safety requirements. Only insert the plug into an outlet with protective conductor terminal.
- Only use intact cables and route them carefully so that they cannot be damaged. Check the power cables regularly to ensure that they are undamaged. Also ensure that nobody can trip over loose cables.
- Only connect the product to a power source with a fuse protection of maximum 20 A.
- Ensure that you can disconnect the product from the power source at any time. Pull the power plug to disconnect the product. The power plug must be easily accessible. If the product is integrated into a system that does not meet these requirements, provide an easily accessible circuit breaker at the system level.



### Cleaning the product

Use a dry, lint-free cloth to clean the product. When cleaning, keep in mind that the casing is not waterproof. Do not use liquid cleaning agents.

### Meaning of safety labels

Safety labels on the product warn against potential hazards.

	<p>Potential hazard Read the product documentation to avoid personal injury or product damage.</p>
	<p>Heavy product Be careful when lifting, moving or carrying the product. Carrying the product requires a sufficient number of persons or transport equipment.</p>

	<p>Electrical hazard</p> <p>Indicates live parts. Risk of electric shock, fire, personal injury or even death.</p>
	<p>Hot surface</p> <p>Do not touch. Risk of skin burns. Risk of fire.</p>
	<p>Protective conductor terminal</p> <p>Connect this terminal to a grounded external conductor or to protective ground. This connection protects you against electric shock if an electric problem occurs.</p>

## 1.2 Labels on R&S SMW200A

Labels on the casing inform about:

- Personal safety, see ["Connecting to power"](#) on page 21.
- Product and environment safety, see [Table 1-1](#).
- Identification of the product, see the serial number on the rear panel.

**Table 1-1: Labels regarding R&S SMW200A and environment safety**

	<p>Labeling in line with EN 50419 for disposal of electrical and electronic equipment after the product has come to the end of its service life. For more information, see <a href="#">Section 17.4, "Disposal"</a>, on page 1377.</p>
---	--

## 1.3 Warning messages in the documentation

A warning message points out a risk or danger that you need to be aware of. The signal word indicates the severity of the safety hazard and how likely it will occur if you do not follow the safety precautions.

### WARNING

Potentially hazardous situation. Could result in death or serious injury if not avoided.

### CAUTION

Potentially hazardous situation. Could result in minor or moderate injury if not avoided.

### NOTICE

Potential risks of damage. Could result in damage to the supported product or to other property.

## 1.4 CE declaration of conformity

The CE declaration of conformity of the base unit is delivered with the product. Keep the document for further reference.

The current version of this CE declaration of conformity is available at:

[www.rohde-schwarz.com/product/smw200a](http://www.rohde-schwarz.com/product/smw200a)

## 1.5 Where to find key documents on Rohde & Schwarz

Certificates issued to Rohde & Schwarz that are relevant for your country are provided at [www.rohde-schwarz.com/key-documents](http://www.rohde-schwarz.com/key-documents), e.g. concerning:

- Quality management
- Environmental management
- Information security management
- Accreditations

## 1.6 Korea certification class B



이 기기는 가정용(B급) 전자파 적합기기로서 주로 가정에서 사용하는 것을 목적으로 하며, 모든 지역에서 사용할 수 있습니다.

## 2 Welcome to the R&S SMW200A

The R&S SMW200A is a new high-performance vector signal generator developed to meet demanding customer requirements. Offering excellent signal characteristics, wide signal bandwidth and straightforward and intuitive operation, the R&S SMW200A makes signal generation fast and easy.

### 2.1 Key features

Outstanding key features of the R&S SMW200A vector signal generator are:

- Frequency range from 100 kHz to 67 GHz
- Optional second RF path with variable frequency range
- Up to 2 GHz I/Q modulation bandwidth (in RF) with internal baseband
- Wideband baseband and vector signal generator in one box
- Support of all important digital standards such as LTE incl. eMTC/NB-IoT, 5G NR, WLAN IEEE 802.11a/b/g/n/j/p/ac/ax/be, GNSS, 3GPP FDD/HSPA/HSPA+
- Generating signals for radar module and receiver tests
- Versatile configuration: from single-path vector signal generator to multichannel MIMO receiver tester
- Optional integrated fading simulator with up to 200 MHz bandwidth
- Ideal for MIMO, MSR, 5G NR or LTE-Advanced applications thanks to up to eight signal sources and up to 64 fading channels
- Implementation of all key MIMO fading scenarios such as 2x2, 3x3, 4x4, 8x4, 4x8, and 2x4x4 using a single instrument
- Internal digital adding of baseband signals, with frequency and level offset
- Excellent signal quality for high accuracy in spectral and modulation measurements
- Intuitive operation via touchscreen with block diagram as key element
- Graphical signal monitoring at practically every point in the signal flow
- SCPI macro recorder and code generator for generating executable remote control code from manual operating steps (for MATLAB®, CVI, etc.)

For more information, refer to the specifications document.

### 2.2 What's new

This manual describes firmware version FW 5.30.305.xx and later of the R&S®SMW200A.

Compared to the previous version, it provides the new features listed below:

- Editorial changes



## 2.3 Documentation overview

This section provides an overview of the R&S SMW200A user documentation. Unless specified otherwise, you find the documents at:

[www.rohde-schwarz.com/manual/smw200a](http://www.rohde-schwarz.com/manual/smw200a)

### 2.3.1 Getting started manual

Introduces the R&S SMW200A and describes how to set up and start working with the product. Includes basic operations, typical measurement examples, and general information, e.g. safety instructions, etc. A printed version is delivered with the instrument.

### 2.3.2 User manuals and help

Separate manuals for the base unit and the software options are provided for download:

- **Base unit manual**  
Contains the description of all instrument modes and functions. It also provides an introduction to remote control, a complete description of the remote control commands with programming examples, and information on maintenance, instrument interfaces and error messages. Includes the contents of the getting started manual.
- **Software option manual**  
Contains the description of the specific functions of an option. Basic information on operating the R&S SMW200A is not included.

The contents of the user manuals are available as help in the R&S SMW200A. The help offers quick, context-sensitive access to the complete information for the base unit and the software options.

All user manuals are also available for download or for immediate display on the internet.

### 2.3.3 Tutorials

The R&S SMW200A provides interactive examples and demonstrations on operating the instrument in the form of tutorials. A set of tutorials is available directly on the instrument.

### 2.3.4 Service manual

Describes the performance test for checking compliance with rated specifications, firmware update, troubleshooting, adjustments, installing options and maintenance.

The service manual is available for registered users on the global Rohde & Schwarz information system (GLORIS):

<https://gloris.rohde-schwarz.com>

### 2.3.5 Instrument security procedures

Deals with security issues when working with the R&S SMW200A in secure areas. It is available for download on the internet.

### 2.3.6 Printed safety instructions

Provides safety information in many languages. The printed document is delivered with the product.

### 2.3.7 Specifications and product brochures

The specifications document, also known as the data sheet, contains the technical specifications of the R&S SMW200A. It also lists the firmware applications and their order numbers, and optional accessories.

The brochure provides an overview of the instrument and deals with the specific characteristics.

See [www.rohde-schwarz.com/brochure-datasheet/smw200a](http://www.rohde-schwarz.com/brochure-datasheet/smw200a)

### 2.3.8 Calibration certificate

The document is available on <https://gloris.rohde-schwarz.com/calcert>. You need the device ID of your instrument, which you can find on a label on the rear panel.

### 2.3.9 Release notes and open source acknowledgment

The release notes list new features, improvements and known issues of the current software version, and describe the software installation.

The software uses several valuable open source software packages. An open source acknowledgment document provides verbatim license texts of the used open source software.

[www.rohde-schwarz.com/firmware/smw200a](http://www.rohde-schwarz.com/firmware/smw200a)

### 2.3.10 Application notes, application cards, white papers, etc.

These documents deal with special applications or background information on particular topics.

[www.rohde-schwarz.com/application/smw200a](http://www.rohde-schwarz.com/application/smw200a)

For some application sheets, see also:

[www.rohde-schwarz.com/manual/smw200a](http://www.rohde-schwarz.com/manual/smw200a)

### 2.3.11 Videos

Find various videos on Rohde & Schwarz products and test and measurement topics on YouTube: <https://www.youtube.com/@RohdeundSchwarz>



On the menu bar, search for your product to find related videos.



Figure 2-1: Product search on YouTube

## 2.4 Scope and content

This description assumes an R&S SMW200A equipped with all available options. Depending on your model and the installed options, some of the functions cannot be available on your instrument.

### Settings and descriptions related to the wideband baseband generator

This description assumes a fully equipped **Standard baseband** R&S SMW200A, so that we can explain all instrument concepts and show the possible configuration and settings. If a particular function requires a special option, this option is stated in the list of the required options. If your instrument is equipped with **Wideband baseband** generator, some sections of this description are not relevant.

The values ranges in the remote control commands correspond to a **Standard baseband** instrument.

### Settings and descriptions related to RF hardware versions

To improve the signal performance of the R&S SMW200A, several hardware components in the RF domain have been replaced. New option numbers denote the hardware modifications.

Accordingly, the description in the user manual has been extended. It applies to all new options, as for example R&S SMW-B1006, but also comprises the former ones.

Differences to instruments with the former RF hardware are referred to as *earlier RF hardware versions*.

See [Appendix: RF Hardware Versions, on page 1397](#).

## 3 Getting started

### 3.1 Preparing for use

Here, you can find basic information about setting up the product for the first time.

#### 3.1.1 Lifting and carrying

For safety information, see "[Lifting and carrying the product](#)" on page 20.

Use the handles for lifting and carrying the R&S SMW200A.

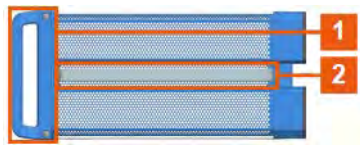

Figure 3-1: Instrument side view with front handles (1) and side handles (2)

#### 3.1.2 Unpacking and checking

1. Unpack the R&S SMW200A carefully.
2. Retain the original packing material. Use it to protect the control elements and connectors when transporting or shipping the R&S SMW200A later.  
See also [Section 16, "Transporting"](#), on page 1356.
3. Using the delivery notes, check the equipment for completeness.
4. Check the equipment for damage.

If the delivery is incomplete or equipment is damaged, contact Rohde & Schwarz.

#### 3.1.3 Choosing the operating site

Specific operating conditions ensure proper operation and avoid damage to the product and connected devices. For information on environmental conditions such as ambient temperature and humidity, see the specifications document.

For safety information, see "[Choosing the operating site](#)" on page 20.

##### Electromagnetic compatibility classes

The electromagnetic compatibility (EMC) class indicates where you can operate the product. The EMC class of the product is given in the specifications document.

- Class B equipment is suitable for use in:

- Residential environments
- Environments that are directly connected to a low-voltage supply network that supplies residential buildings
- Class A equipment is intended for use in industrial environments. It can cause radio disturbances in residential environments due to possible conducted and radiated disturbances. It is therefore not suitable for class B environments. If class A equipment causes radio disturbances, take appropriate measures to eliminate them.

### 3.1.4 Setting up the R&S SMW200A

See also:

- ["Setting up the product"](#) on page 20
- ["Intended use"](#) on page 19

#### 3.1.4.1 Placing the R&S SMW200A on a bench top

##### To place the product on a bench top

1. Place the product on a stable, flat and level surface. Ensure that the surface can support the weight of the product. For information on the weight, see the specifications document.
2. **CAUTION!** Foldable feet can collapse. For safety information, see ["Setting up the product"](#) on page 20.  
Always fold the feet completely in or out. With folded-out feet, do not place anything on top or underneath the product.
3. **WARNING!** A stack of products can fall over and cause injury. Never stack more than three products on top of each other. Instead, mount them in a rack.

Stack as follows:

- If the products have foldable feet, fold them in completely.
- It is best if all products have the same dimensions (width and length). If the products have different dimensions, stack according to size and place the smallest product on top.
- Do not exceed the permissible total load placed on the product at the bottom of the stack:
  - 50 kg when stacking products of identical dimensions (left figure).
  - 25 kg when stacking smaller products on top (middle figure).

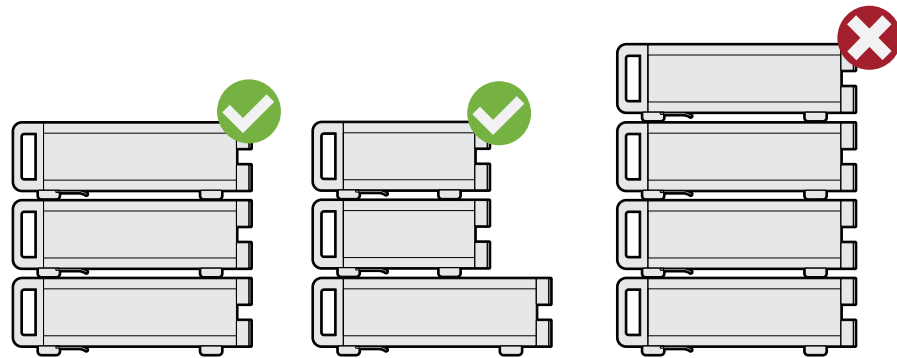

Left = Stacked correctly, same dimensions  
 Middle = Stacked correctly, different dimensions  
 Right = Stacked incorrectly, too many products

#### 4. **NOTICE!** Overheating can damage the product.

Prevent overheating as follows:

- Keep a minimum distance of 10 cm between the fan openings of the product and any object in the vicinity to provide sufficient airflow and ventilation.
- Do not place the product next to heat-generating equipment such as radiators or other products.

#### 3.1.4.2 Mounting the R&S SMW200A in a rack

##### To prepare the rack

1. Observe the requirements and instructions in "[Setting up the product](#)" on page 20.
2. **NOTICE!** Insufficient airflow can cause overheating and damage the product. Design and implement an efficient ventilation concept for the rack.

##### To mount the R&S SMW200A in a rack

1. Use an adapter kit that fits the dimensions of the R&S SMW200A to prepare the instrument for rack mounting.
  - a) Order the rack adapter kit designed for the R&S SMW200A.  
For more information, refer to the specifications document.
  - b) Mount the adapter kit. Follow the assembly instructions provided with the adapter kit.
2. **WARNING!** The R&S SMW200A is heavy. For safety information, see "[Lifting and carrying the product](#)" on page 20. Use a lifting equipment to lift the R&S SMW200A.  
Lift the product to shelf height.
3. Grab the handles at the front.

4. Push the R&S SMW200A onto the shelf until the rack brackets fit closely to the rack.
5. Tighten all screws at the rack brackets with a tightening torque of 1.2 Nm to secure the R&S SMW200A in the rack.

#### To unmount the R&S SMW200A from a rack

1. Loosen the screws at the rack brackets.
2. **WARNING!** The R&S SMW200A is heavy. For safety information, see "[Lifting and carrying the product](#)" on page 20. Use a lifting equipment to lift the R&S SMW200A.  
Bring the lifting equipment to shelf height.
3. Remove the R&S SMW200A from the rack.
4. If placing the R&S SMW200A on a bench top again, unmount the adapter kit from the R&S SMW200A. Follow the instructions provided with the adapter kit.

### 3.1.5 Considerations for test setup

For safety information, see "[Connecting the product](#)" on page 21.

#### Cable selection to minimize electromagnetic interference (EMI)

Electromagnetic interference (EMI) can affect the measurement results.

To suppress electromagnetic radiation during operation:

- Use high-quality shielded cables, for example, double-shielded RF, LAN and USB cables.
- Always terminate open cable ends.
- Ensure that connected external devices comply with EMC regulations.
- Use cables of the same type and equal length for connection to the I/Q and I/Q Bar interfaces of the instrument.  
How to: "[To connect instruments to the I/Q analog interface](#)" on page 189
- Use the cable R&S SMU-Z6 for connection to the DIG I/Q interfaces of the instrument. The cable is available under order number 1415.0201.02.  
How to: "[To connect instruments to the I/Q digital interface](#)" on page 192.
- Use the cable R&S DIGIQ-HS for connection to the HS DIG I/Q interfaces of the instrument. The cable is available under order number 3641.2948.03.  
How to: [Section 3.1.13, "Connecting to HS DIG I/Q"](#), on page 36

#### Signal input and output levels

Keep the signal levels within the specified ranges to avoid damage to the R&S SMW200A and connected devices.

For more information, refer to the specifications document.

### Preventing electrostatic discharge (ESD)

Electrostatic discharge is most likely to occur when you connect or disconnect a DUT.

- ▶ **NOTICE!** Electrostatic discharge can damage the electronic components of the product and the device under test (DUT).

Ground yourself to prevent electrostatic discharge damage:

- a) Use a wrist strap and cord to connect yourself to ground.
- b) Use a conductive floor mat and heel strap combination.

## 3.1.6 Connecting to power

For safety information, see "[Connecting to power](#)" on page 21.

1. Plug the AC power cable into the AC power connector on the rear panel. Only use the AC power cable delivered with the R&S SMW200A.
2. Plug the AC power cable into a power outlet with ground contact.  
The required ratings are listed next to the AC power connector.

For more information, refer to the specifications document.

## 3.1.7 Connecting to LAN

### Network environment

Before connecting the product to a local area network (LAN), consider the following:

- Install the latest firmware to reduce security risks.
- For internet or remote access, use secured connections if applicable.
- Ensure that the network settings comply with the security policies of your company. Contact your local system administrator or IT department before connecting your product to your company LAN.
- When connected to the LAN, the product may potentially be accessed from the internet, which may be a security risk. For example, attackers might misuse or damage the product.

### To connect to LAN

- ▶ Connect the LAN socket on the rear panel via an RJ-45 cable to the LAN.

Using DHCP (dynamic host configuration protocol), the R&S SMW200A assigns the IP address automatically.

If connected to the LAN, the R&S SMW200A displays the IP address and the host name at the left bottom of the block diagram.



10.100.10.10 inst-123456

1 = IP address

2 = Hostname

If disconnected from the LAN, the R&S SMW200A displays the IP address *0.0.0.0*.

See also [Section 13.8, "Setting up remote control"](#), on page 860.

### 3.1.8 Connecting USB devices

You can connect or disconnect all USB devices from the R&S SMW200A during operation.

#### To connect USB storage devices

USB storage devices, such as memory sticks, allow data transfer from or to the R&S SMW200A. You can also use them for firmware updates.

1. Connect the USB storage device to any of the USB connectors.
2. Connect the device directly, without a connecting cable.  
Connecting cables can cause electromagnetic radiation and impair a measurement result.

#### To connect USB devices with an external power supply

1. **NOTICE!** Connected devices with external power supply can feed back current into the 5 V power supply of the USB interface and thus damage the R&S SMW200A.  
Ensure that there is no connection between the positive pole of the power supply and the +5 V power pin of the USB interface (VBUS).
2. Connect the USB storage device to any of the USB connectors on the front panel or rear panel.

#### To connect a keyboard

- ▶ Connect the keyboard to any of the USB connectors on the front panel or rear panel.

When connected, the R&S SMW200A detects the keyboard automatically. A detected keyboard has the default layout English – US.

#### To connect a mouse

- ▶ Connect the mouse to any of the USB connectors.

When connected, the R&S SMW200A detects the mouse automatically.

### To connect power sensors

Connect the power sensors of the R&S NRP families to any of the USB connectors on the front panel or rear panel.

See [Section 8.12.4, "Using power sensors"](#), on page 600.

## 3.1.9 Connecting to RF coaxial connectors

Here, you find information on how to prepare and to connect to RF coaxial connectors of the R&S SMW200A. Use these RF connectors, for example, for output of the RF signal or for input of an external reference signal.

### To prepare for connecting

1. **NOTICE!** Damaged or not clean connections can lead to RF insertion loss and mismatch, and even premature wear of the connectors.  
Before connecting to the port, inspect the RF connector visually. Check that it is clean, undamaged and mechanically compatible.
2. **NOTICE!** DC voltage at the RF connector can damage the instrument. Never apply DC voltage to the RF input connectors.  
Make sure that the values are within the DC limits given in the specifications document.
3. If your test setup has a DC component at the RF input, insert a DC blocker.
4. Use a high-quality RF cable that matches the RF connector type. See also "[Cable selection to minimize electromagnetic interference \(EMI\)](#)" on page 31.
5. You can connect to two kinds of connectors:
  - "[To connect to screwable connectors](#)" on page 34
  - "[To connect to pluggable connectors](#)" on page 35

### To connect to screwable connectors

To connect the cable with the connector, proceed as follows:

1. Carefully align the connector of the cable and the connector along a common axis.
2. Mate the connectors along the common axis until the male pin of the inner connector engages with the female socket of the outer connector.
3. Turn the nut of the outer connector until the connectors are firmly coupled.
4. **NOTICE!** Excessive tightening can damage the connectors.  
Using a calibrated torque wrench torque the nut to the limit as in the table below. Hold the opposite connector part stationary with a spanner.

The R&S SMW200A provides screwable RF connectors as in [Table 3-1](#).

**Table 3-1: Connector name, type, size, torque limit and nut opening**

Connector		Torque limit		Nut opening	
Type	Name	lb-Inch	Nm	Inch	mm
N	RF A/RF B*)	13.3	1.5	3/4	20
SMA	LO IN LO OUT REF IN 1 GHz REF OUT 1 GHz	5	0.56	5/16	8
2.92 mm	RF A/RF B*)	8	0.9	5/16	8
1.85 mm	RF A/RF B*)	8	0.9	5/16	8

\*) maximum frequency  $f_{\max}$  depends on the connector type:  $f_{\max}(\text{N}) \leq 7 \text{ GHz}$ ,  $f_{\max}(\text{2.92 mm}) \leq 40 \text{ GHz}$ ,  $f_{\max}(\text{1.85 mm}) \leq 67 \text{ GHz}$

### To connect to pluggable connectors

The R&S SMW200A provides pluggable Bayonet Neill-Concelman (BNC) connectors.

To connect the RF cable with the BNC connector, proceed as follows:

1. Carefully align the connector of the cable and the BNC connector along a common axis.
2. Mate the connectors along the common axis until the male pin of the connector of the cable engages with the female socket of the BNC connector.

For more information on handling and maintaining coaxial RF connectors, see the application note [1MA99](#).

For information on mounting test port adapters onto the RF connector, see the application note [1MA100](#).

### 3.1.10 Connecting to RF A/RF B

1. Before connecting, disable the RF output:  
In the block diagram, switch off the RF block.
2. For connection, use the connector "RF A/RF B" on the front panel.  
See "[To connect to screwable connectors](#)" on page 34.

#### To prevent RF output switch-off

- **NOTICE!** If you set a too high output level, the reflected power can exceed a limit forcing the R&S SMW200A to switch off the RF output.

Connect a load with sufficient return loss.

For more information, refer to the specifications document.

### 3.1.11 Connecting to LO In/Out

For connection, the R&S SMW200A provides SMA connectors on the rear panel. See ["To connect to screwable connectors"](#) on page 34.

See also [Section 8.9, "Local oscillator coupling"](#), on page 500.

### 3.1.12 Connecting to REF IN/REF OUT

For connection, the R&S SMW200A provides BNC connectors or SMA connectors on the rear panel. See ["To connect to pluggable connectors"](#) on page 35 and ["To connect to screwable connectors"](#) on page 34.

### 3.1.13 Connecting to HS DIG I/Q

#### To connect to the QSFP+ interface

1. For connection, use the cable R&S DIGIQ-HS.  
See ["Cable selection to minimize electromagnetic interference \(EMI\)"](#) on page 31.
2. Hold the QSFP+ plug of the cable by its panes.
3. Turn the QSFP+ cable, so that the release tab shows upwards.
4. Insert and push the QSFP+ plug into the QSFP+ cage.

If you hear a clicking sound, the plug engaged correctly with the cage and the cable is connected to the interface.

#### To disconnect from the QSFP+ interface

1. **NOTICE!** If you pull the cable, you can damage the cable and the HS DIG I/Q connector.  
Pull the release tab.
2. Pull the QSFP+ plug out of the QSFP+ cage.

#### About the QSFP+ interface

The "HS DIG I/Q" connector is a QSFP+ (quad small form factor pluggable) interface or QSFP28 interface. The connector socket has two components: a QSFP+ cage and a QSFP+ connector. The QSFP+ cable is equipped with the QSFP+ plug. The interface supports a maximum bandwidth of up to 50 Gsample/s with active optical cables.

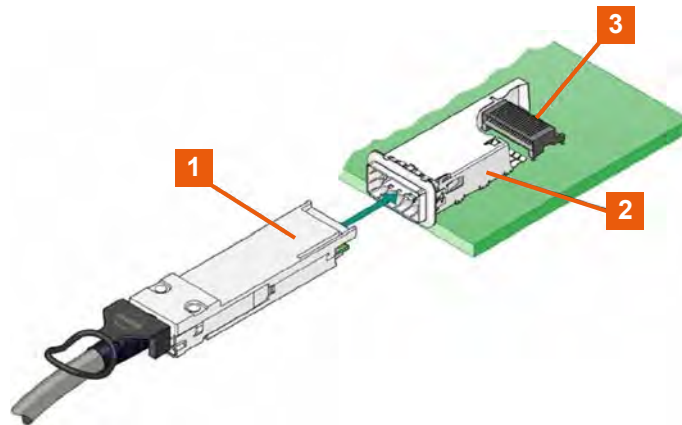

- 1 = QSFP+ plug
- 2 = QSFP+ cage
- 3 = QSFP+ connector

See also:

- [Section 4.6, "Digital baseband input settings"](#), on page 151.
- [Section 4.7, "I/Q digital output settings"](#), on page 164.
- [Section 4.4.2, "I/Q stream mapper settings"](#), on page 127.

### 3.1.14 Switching on or off

The following table provides an overview of power states, LEDs and positions of the power switch.

**Table 3-2: Overview of power states**

State	LED	Position of power switch
Off	● gray	[0]
Standby	● yellow	[1]
Ready	● green	[1]

#### To switch on the R&S SMW200A

The R&S SMW200A is off but connected to power. See [Section 3.1.6, "Connecting to power"](#), on page 32.

1. Set the switch on the power supply to position [1] on the rear panel.  
The LED of the [On/Standby] key on the front panel is yellow.
2. Wait until the oven-controlled oscillator (OCXO) warms up.  
For more information, refer to the specifications document.
3. Press the [On/Standby] key on the front panel.

The LED changes to green. The R&S SMW200A boots.

After booting, the R&S SMW200A starts up displaying the block diagram on the screen on the front panel.

#### To check startup functions

When starting for the first time, the R&S SMW200A starts with the default settings. When restarting, the R&S SMW200A recalls the instrument configuration before shut-down.

See [Section 11.4.2, "Saving and recalling instrument settings"](#), on page 712.

When switched on, the R&S SMW200A monitors the main functions and logs erroneous functions. See the following:

See [Section 15.4, "Querying notifications"](#), on page 1344.

#### To shut down the product

The product is in the ready state.

- ▶ Press the [On/Standby] key.

The operating system shuts down. The LED changes to yellow. The product changes to standby state.

In the standby state, the power switch circuits and the OCXO are active. To deactivate them, disconnect the instrument from the power supply.

#### To disconnect from power

The R&S SMW200A is in the standby state.

1. **NOTICE!** Risk of data loss. If you disconnect the product from power when it is in the ready state, you can lose settings and data. Shut it down first.  
Set the toggle switch on the power supply to position [0].  
The LED of the [On/Standby] key is switched off.
2. Disconnect the R&S SMW200A from the power source.

## 3.2 Instrument tour

This chapter explains the control elements and the connectors of the R&S SMW200A. The views of the front panel and the rear panel help you to get familiar with the instrument and to perform the first steps. For specifications of the interfaces, see the specifications document.

The meanings of the labels on the R&S SMW200A are described in [Section 1.2, "Labels on R&S SMW200A"](#), on page 22.

### 3.2.1 Front panel tour

This section provides an overview of the control elements and connectors on the front panel of the R&S SMW200A. On the [rear panel](#), you find all further connectors of the unit.

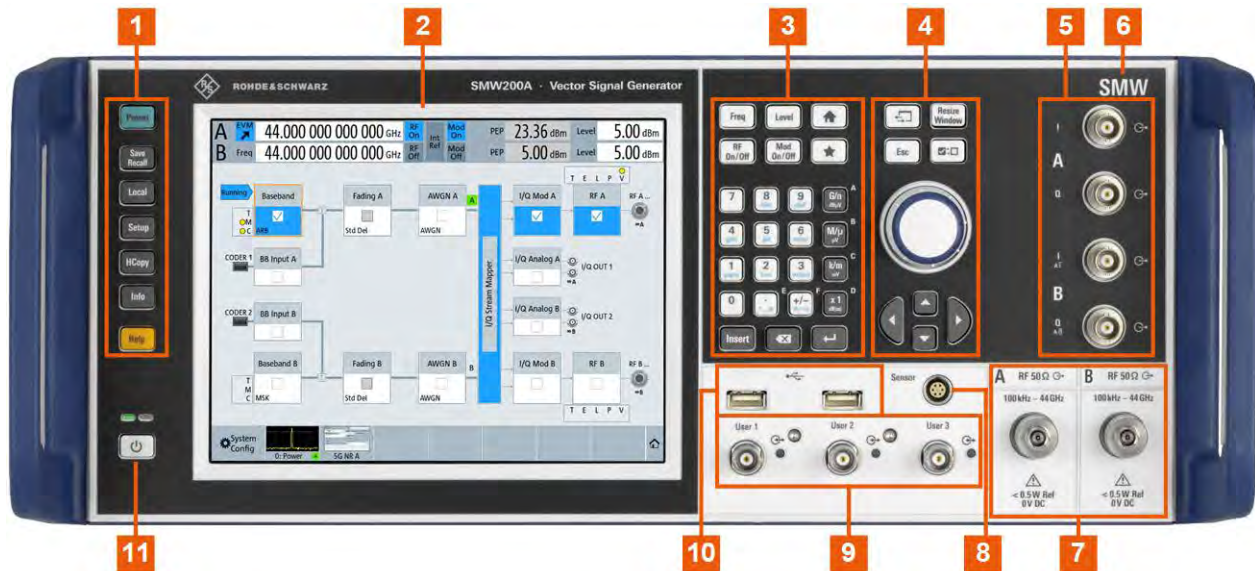
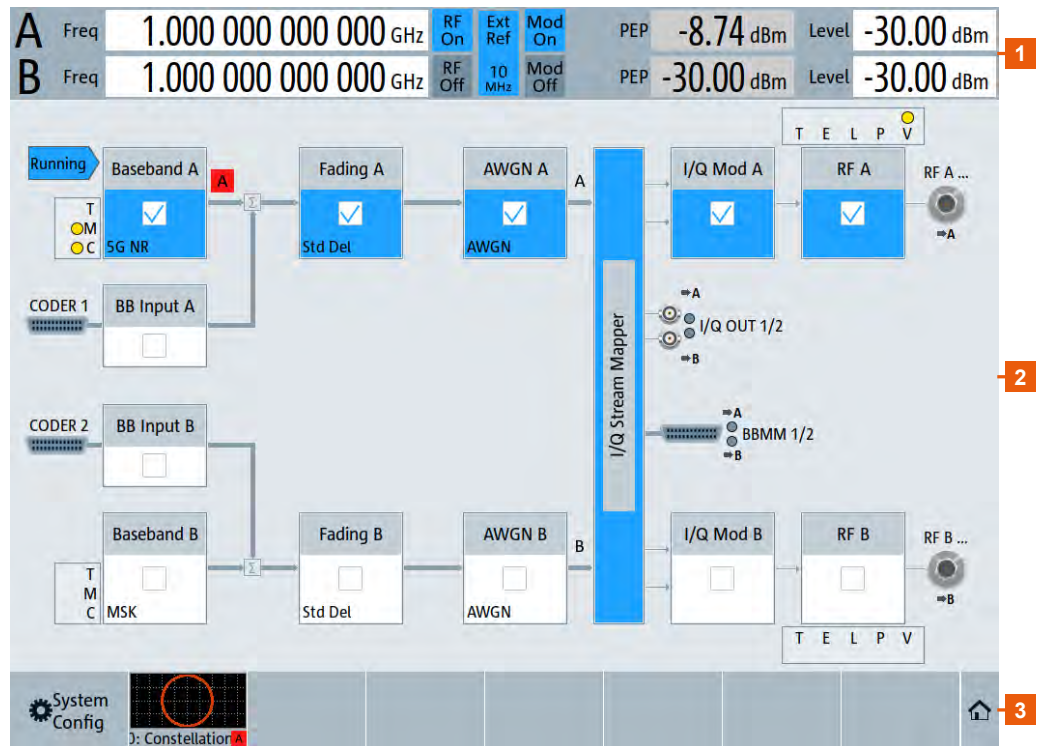

Figure 3-2: Front panel view of R&S SMW200A (R&S SMW-B1044/-B2044)

- 1 = Utility keys
- 2 = Touchscreen
- 3 = Function keys and Keypad
- 4 = Navigation controls
- 5 = I/Q, I/Q Bar
- 6 = Product family name
- 7 = RF A/RF B
- 8 = SENSOR
- 9 = USER x
- 10 = USB, [page 44](#)
- 11 = On/Standby key, [page 41](#)

#### 3.2.1.1 Touchscreen

The block diagram and the most important settings are displayed on the screen on the front panel. The screen display also provides status and setting information and allows you to quickly reconfigure the signal flow. The screen is touch-sensitive, offering an alternative means of user interaction for quick and easy handling of the instrument.



**Figure 3-3: Touchscreen elements**

- 1 = Status bar (frequency and level display)
- 2 = Block diagram
- 3 = Taskbar/softkey bar

Any user interface elements that react to a click by a mouse pointer also react to a tap on the screen, and vice versa. Using the touchscreen, you can perform the following tasks (among others) by the tap of your finger:

- Changing a setting
- Selecting new settings
- Scrolling through the list of parameters
- Saving or recalling settings
- Routing the signal flow
- Opening and closing dialogs

See also:

- [Section 3.5, "Operating the instrument"](#), on page 86, for operating the touchscreen.
- [Section 17.1, "Cleaning"](#), on page 1357, for cleaning the screen.



### 3.2.1.2 Keys

#### Utility keys

The utility keys set the instrument to a defined state, provide information on the instrument and assist.

For more information, see [Section 12, "General instrument functions"](#), on page 736.

**Table 3-3: Utility keys**

Utility key	Assigned functions
[PRESET]	Sets the instrument to a defined state
[SAVE/RCL]	Saves and loads instrument setting Accesses the file manager
[LOCAL]	Switches from remote control to local (manual) control
[SETUP]	Accesses the general instrument settings
[HCOPY]	Opens the "Hardcopy" dialog for storing the current display in a file
[INFO]	Displays status messages, error messages, and warnings
[HELP]	Displays context-sensitive help text

#### On/Standby key

The [On/Standby] key switches the instrument from the standby to the ready state or vice versa.

The LED above the [On/Standby] key indicates the instrument state, see [Section 3.1.14, "Switching on or off"](#), on page 37.

#### Function keys

Function keys provide access to the most common generator settings and functions.

A detailed description of the corresponding functions is provided in the user manual.

**Table 3-4: Function keys**

Function key	Assigned functions
[FREQ]	Activates frequency entry. <sup>1)</sup>
[LEVEL]	Activates level entry. <sup>1)</sup>
[Diagram]	Brings the block diagram to the foreground. Active dialogs are minimized.
[RF ON/OFF]	Switches the RF output on and off. <sup>2)</sup>
[MOD ON/OFF]	Switches the modulations on and off. <sup>2)</sup>
[USER]	Key with a customizable function. You can define the action to be executed.

Function key	Assigned functions
<b>Function execution</b> (in navigation controls area)	
[ON/OFF TOGGLE]	<ul style="list-style-type: none"> <li>Switches highlighted elements or a function block on and off.</li> <li>Switches between two or more settings, e.g. items of selection lists. At the end of a list, the cursor is set on the first entry again.</li> </ul>

<sup>1)</sup> The entry field that was active last is activated. Press the key again to activate the entry field of the other path.

<sup>2)</sup> Status is displayed in the "Status bar". The key switches off all RF signals/modulations; press the key again to restore the last active status.

### Keypad

The keypad is used to enter alphanumeric parameters, including the corresponding units. It contains the following keys:

**Table 3-5: Keys on the keypad**

Type of key	Description
Alphanumeric keys	Enter numbers and (special) characters in edit dialog boxes.
Decimal point	Inserts a decimal point "." at the cursor position.
Sign key	Changes the sign of a numeric parameter. For an alphanumeric parameter, inserts a "-" at the cursor position.
Unit keys (G/n dB $\mu$ V, M/ $\mu$ $\mu$ V, k/m mV and x1 dB(m))	These keys add the selected unit to the entered numeric value and complete the entry. For level entries (e.g. in dB) or dimensionless values, all units have the value "1" as the multiplying factor. Thus, they have the same function as a [Enter] key.
[INSERT] key	Toggles between insert and overwrite mode.
[ESC] key	Closes all kinds of dialog boxes, if the edit mode is not active. Quits the edit mode, if the edit mode is active. Closes dialog boxes that contain a "Cancel" button. For "Edit" dialog boxes, the following applies: <ul style="list-style-type: none"> <li>If a data entry has been started, it retains the original value and closes the dialog box.</li> <li>If data entry has not been started or has been completed, it closes the dialog box.</li> </ul>
[Backspace] key	If an alphanumeric entry has already been started, this key deletes the character to the left of the cursor.
[Enter] key	Has the same effect as pressing the rotary knob. <ul style="list-style-type: none"> <li>Concludes the entry of dimensionless entries. The new value is accepted.</li> <li>With other entries, this key can be used instead of the default unit key.</li> <li>In a dialog box, selects the default or focused element.</li> <li>Calls the next dialog level.</li> <li>Confirms and closes open input windows.</li> </ul>

## Navigation controls

The navigation controls include a rotary knob, navigation keys, and the display keys. They allow you to navigate within the display or within dialog boxes.

### Rotary knob

The rotary knob has several functions:

- Increments (clockwise direction) or decrements (counterclockwise direction) numeric instrument parameters at a defined step size.
- Moves the selection, e.g. to a function block in the block diagram
- Shifts the selection bar within focused areas (e.g. lists).
- Acts like the [Enter] key when it is pressed.

### Navigation keys

The navigation keys can be used alternatively to the rotary knob to navigate through dialog boxes, diagrams, or tables.

**Table 3-6: Navigation keys**

Type of key	Description
[Up/Down] key	The [Up] and the [Down] key does the following: <ul style="list-style-type: none"> <li>• In a numeric edit dialog box, increase or decrease the instrument parameter.</li> <li>• In a list, scroll forward and backward through the list entries.</li> <li>• In a table, move the selection bar vertically.</li> <li>• In windows or dialog boxes with vertical scrollbar, move the scrollbar.</li> </ul>
[Left/Right] key	The [Left] and the [Right] key does the following: <ul style="list-style-type: none"> <li>• In an alphanumeric edit dialog box, move the cursor.</li> <li>• In a list, scroll forward and backward through the list entries.</li> <li>• In a table, move the selection bar horizontally.</li> <li>• In windows or dialog boxes with horizontal scrollbar, move the scrollbar.</li> </ul>

### Display keys

The display keys arrange different windows on the display.

**Table 3-7: Display keys**

Display key	Assigned functions
[NEXT WINDOW]	Toggles between the active dialogs
[RESIZE WINDOW]	Adjusts the size of the active dialog to use the whole height of the display.
[ESC]	Closes all kinds of dialog boxes, if the edit mode is not active. Quits the edit mode, if the edit mode is active. Equals selecting the "Cancel" button in dialogs, if provided. For "Edit" dialog boxes, the following applies: <ul style="list-style-type: none"> <li>• If a data entry has been started, it retains the original value and closes the dialog box.</li> <li>• If data entry has not been started or has been completed, it closes the dialog box.</li> </ul>

### 3.2.1.3 Connectors

The RF and I/Q connectors and various other interface connectors are on the front panel.

#### I/Q, I/Q Bar

BNC connectors for input of external I/Q signals for analog modulation. The signals are fed directly into the I/Q modulator.

One pair of I and Q inputs are available per installed RF path.

Use the connectors for connections as follows:

- I/Q connectors: Direct (single-ended) or positive differential input of analog I/Q signals
- I/Q Bar connectors: Negative differential input of analog I/Q signals

How to:

- ["To apply an external analog signal directly to the I/Q modulator"](#) on page 211
- ["To apply an external differential analog signal directly to the I/Q modulator"](#) on page 212

#### USB

Two female USB (universal serial bus) 2.0 connectors of type A (host USB). You can connect, for example, a keyboard, a mouse or a USB memory stick.

Further USB connectors of type A (host USB) and type B (USB Device) are available on the rear panel.

How to: [Section 3.1.8, "Connecting USB devices"](#), on page 33

#### SENSOR

Connector for R&S NRP power sensors.

To work with these sensors, use the R&S SMW200A applications power viewer, power control, sensor configuration and sensor mapping.

See also:

- [Section 8.12.4, "Using power sensors"](#), on page 600
- [Section 8.12.3, "User correction"](#), on page 588

#### USER x

BNC multipurpose connectors for defining input signals and output signals.



The [Table 3-8](#) lists the signals assigned to the USER x connectors in the default instrument state.

**Table 3-8: Default configuration of the USER x connectors**

USER connector	Direction	Default assigned signal
1	Output	"Baseband A Marker 1"
2	Output	"Baseband A Marker 2"
3	Input	"Global Trigger 1"

A dedicated LED indicates the connector status:

-  green: an input connector

-  yellow: an output connector
-  no light / gray: the connector is not active

See also [Section 12.2, "Configuring local and global connectors"](#), on page 742.

### RF A/RF B

Female connector for output of the RF signal of path A and path B.

The connector type depends on the maximum frequency  $f_{\max}$ , see table below.

**Table 3-9: Frequency options, connector types and frequency ranges**

Frequency option	Connector type	Frequency range
RF A: R&S SMW-B1003/-B1006/-B1007 RF B: R&S SMW-B2003/-B2006/-B2007	N female	$f_{\max} \leq 7.5$ GHz
RF A: <ul style="list-style-type: none"> <li>• R&amp;S SMW-B1012/-B1020/-B1031/-B1040</li> <li>• R&amp;S SMW-B1040N</li> </ul> RF B: R&S SMW-B2012/-B2020/-B2031	2.92 mm female Instrument equipped with interchangeable test port adapter.	$f_{\max} \leq 40$ GHz
RF A: <ul style="list-style-type: none"> <li>• R&amp;S SMW-B1044/-B1056/-B1067</li> <li>• R&amp;S SMW-B1044N/-B1056N/-B1067N</li> <li>• R&amp;S SMW-B1044O/-B1056O/-B1067O</li> </ul> RF B: R&S SMW-B2044/-B2044N/-B2044O	1.85 mm female Instrument equipped with interchangeable female/female wear and tear adapter.	$f_{\max} \leq 67$ GHz

**Note:** The PC 1.85 mm male connector for up to 67 GHz comes with a protective 1.85 mm female adapter to prevent the sensitive connector from damage. It is available as a spare part, and can be replaced if damaged. Contact Rohde & Schwarz customer support.

How to: [Section 3.1.10, "Connecting to RF A/RF B"](#), on page 35

## 3.2.2 Rear panel tour

This section provides an overview of the connectors on the rear panel of the instrument.



Figure 3-4: Rear panel view of R&S SMW200A (R&S SMW-B9/-B13XT)

- 1 = Connectors for multipurpose RF signals and remote control
- 2 = Processing board connectors and power supply
- 3 = Instrument boards R&S SMW-B10/-B13T/-B14 (standard baseband)  
 = Instrument boards R&S SMW-B9/-B13XT/-B15 (wideband baseband)

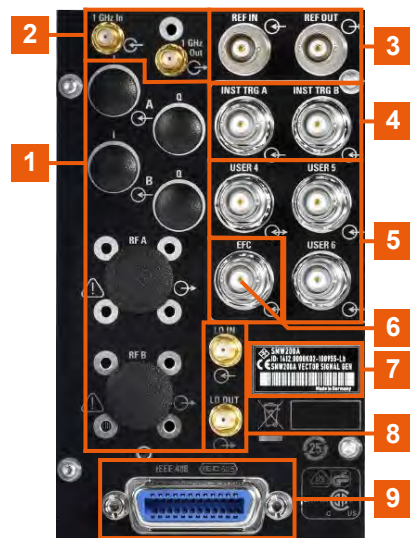

Figure 3-5: Connectors for multipurpose RF signals and remote control

- 1 = Connectors for rack use: I/Q and RF A/RF B
- 2, 3 = REF IN/REF OUT
- 4 = INST TRIG x
- 5 = USER x
- 6 = EFC
- 7 = Serial number (six digits in the string 1412.0000.02-<serial number>-<checksum>)
- 8 = LO IN/LO OUT
- 9 = IEC 625/IEEE 488



Figure 3-6: Processing board connectors and power supply

- 1 = System drive (SSD)
- 2 = AC power supply connector and switch
- 3 = USB/USB Device
- 4 = LAN
- 5, 6 = Display Port, HDMI

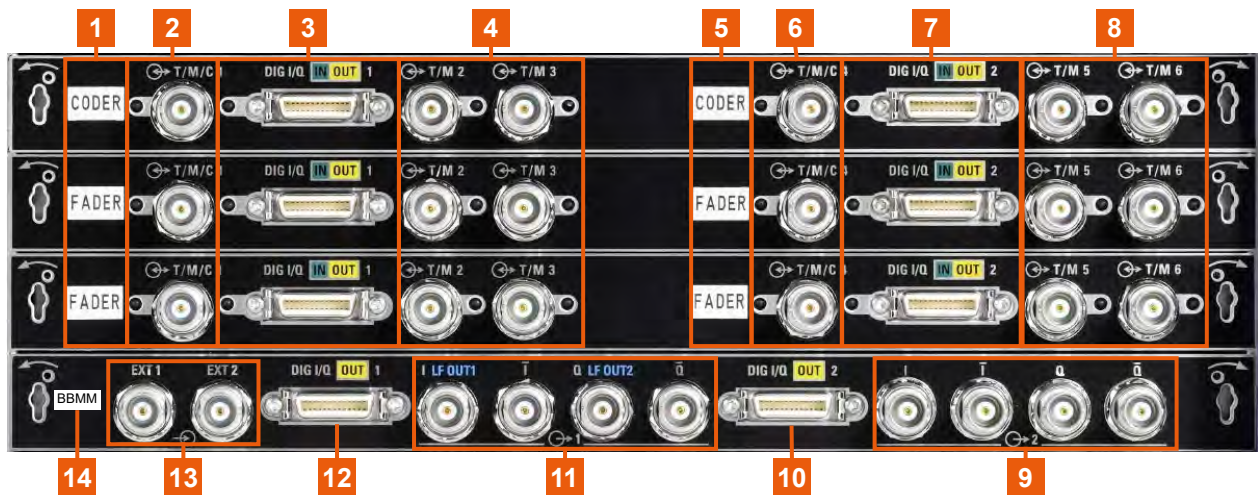

Figure 3-7: Instrument boards R&S SMW-B10/-B13T/-B14 (standard baseband)

- 1, 5, 14 = Board designation (CODER, FADER, BBMM)
- 2, 4, 6, 8 = T/M/C
- 3, 7, 10, 12 = DIG I/Q
- 9, 11 = I/Q, I/Q Bar
- 13 = EXT 1/2

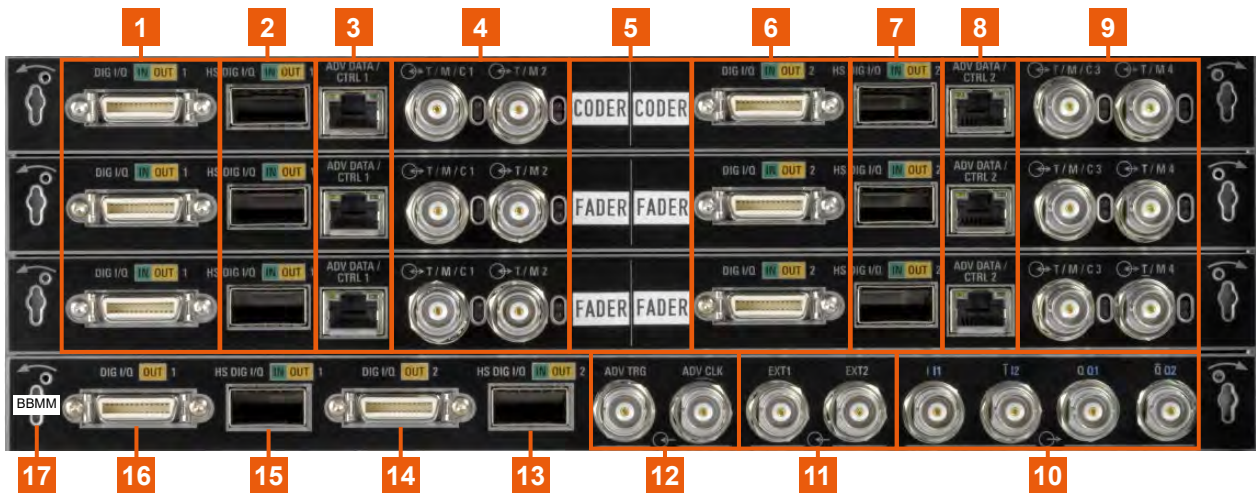

Figure 3-8: Instrument boards R&S SMW-B9/-B13XT/-B15 (wideband baseband)

- 1, 6, 14, 16 = DIG I/Q
- 2, 7, 13, 15 = HS DIG I/Q
- 3, 8 = ADV DATA/CTRL
- 4, 9 = T/M/C
- 5, 17 = Board designation (CODER, FADER, BBMM)
- 10 = I/Q, I/Q Bar
- 11 = EXT 1/2
- 12 = ADV TRG, ADV CLK

### 3.2.2.1 Connectors

#### I/Q

Rear panel I/Q input connectors, recommended for use of the instrument in a 19" rack. See "I/Q, I/Q Bar" on page 44.

How to:

- [Section 3.1.4.2, "Mounting the R&S SMW200A in a rack"](#), on page 30
- ["To apply an external analog signal directly to the I/Q modulator"](#) on page 211
- ["To apply an external differential analog signal directly to the I/Q modulator"](#) on page 212

#### RF A/RF B

Rear panel RF output connectors for the first RF path (option R&S SMW-B81/-B83) and the second RF path (option R&S SMW-B82/-B84). These options are recommended for use of the instrument in a 19" rack.

How to:

- [Section 3.1.4.2, "Mounting the R&S SMW200A in a rack"](#), on page 30
- [Section 3.1.10, "Connecting to RF A/RF B"](#), on page 35

#### REF IN/REF OUT

Input/output for external reference signal.

BNC connectors for reference signals from 1 MHz to 100 MHz.



SMA connectors for 1 GHz reference signals.

The external reference is used for both paths.

How to: [Section 3.1.12, "Connecting to REF IN/REF OUT"](#), on page 36

### USER x

BNC multipurpose connectors for defining input signals and output signals.

[Table 3-10](#) lists the signals assigned to the USER x connectors in the default instrument state.

**Table 3-10: Default configuration of the USER x connectors**

Connector	Direction	Default assigned signal
"USER 4"	"Input"	"Global Trigger 2"
"USER 5"	"Output"	"Signal Valid A"
"USER 6"	"Not used"	"None"

A dedicated LED indicates the connector status:

- ● green: an input connector
- ● yellow: an output connector
- ● no light / gray: the connector is not active

See also [Section 12.2, "Configuring local and global connectors"](#), on page 742.

### EFC

BNC connector for input of an EFC (external frequency control) signal for electronic tuning of the internal reference frequency.

See [Section 8.8, "Reference oscillator"](#), on page 491.

### LO IN/LO OUT

Option: R&S SMW-B90

SMA connector for local oscillator input and output for phase-coherent RF signal:

- LO IN: Input of phase coherence signal
- LO OUT: Output of phase coherence signal

How to: [Section 3.1.11, "Connecting to LO In/Out"](#), on page 36

### IEC 625/IEEE 488

General purpose interface bus (GPIB) interface for remote control of the instrument. The interface complies with the standards IEC 625, IEEE 488 and SCPI.

Use this interface to connect a computer for remote control of the R&S SMW200A. See also the following sections:

- [Section 13.2.3, "GPIB interface \(IEC/IEEE bus interface\)"](#), on page 822
- [Section 13.5.3, "GPIB address settings"](#), on page 834
- [Section F.2, "GPIB interface"](#), on page 1395

### System drive (SSD)

Solid-state drive (hard disk).

For security reasons, the hard disk is bound to the specific R&S SMW200A. You can remove it from the instrument, but you cannot use it in other instruments.

See also ["To remove the system drive"](#) on page 708.

### AC power supply connector and switch

Mains power switch for performing the following tasks:

- Connecting the internal power supply to the power source
- Disconnecting the internal power supply from the power source

How to: [Section 3.1.6, "Connecting to power"](#), on page 32.

### USB/USB Device

- Two female USB (universal serial bus) 3.1 connectors of type A (host USB), to connect devices like a keyboard, a mouse, a memory stick, or the R&S NRP-Z3/Z4 cable for the R&S NRP power sensors.
- Female USB 3.0 connector of type B (USB Device), for example, for remote control.

How to: [Section 3.1.8, "Connecting USB devices"](#), on page 33

### LAN

RJ-45 connector to connect the R&S SMW200A to a LAN for remote control, remote operation, and data transfer.

How to: [Section 3.1.7, "Connecting to LAN"](#), on page 32

### Display Port, HDMI

Provided for future use.

### T/M/C

BNC multipurpose input/output trigger/marker/clock connectors.

The number of connectors depends on the installed baseband options:

- Standard baseband generator (R&S SMW-B10):  
One T/M/C and two T/M connectors per board.
- Wideband baseband generator (R&S SMW-B9):  
One T/M/C and one T/M connectors per board

Define the input/output signal first. [Table 3-11](#) lists the configuration of the local connectors in the default instrument state.

**Table 3-11: Default configuration of the T/M/C connectors (standard baseband)**

T/M/C connector	Direction	Default assigned signal	Remark
1, 4	Output	Clock	Local clock signal for the particular baseband
2, 5	Input	Trigger	Local trigger signal for the particular baseband
3, 6	Output	Marker 3	Marker output signal from the particular baseband

**Table 3-12: Default configuration of the T/M/C connectors (wideband baseband)**

T/M/C connector	Direction	Default assigned signal
1	Output	Symbol clock
2	Input	External serial data

A dedicated LED indicates the connector status:

- ● green: an input connector
- ● yellow: an output connector
- ● no light / gray: the connector is not active

See also the chapters in the user manual:

- [Section 5.5.1.1, "About data signals"](#), on page 224
- [Section 12.2, "Configuring local and global connectors"](#), on page 742

### DIG I/Q

Connectors for the input/output of a digital I/Q signal from and to a Rohde & Schwarz instrument, like a signal generator, signal analyzer, the R&S®IQW, or the R&S®CMW500.

The table below provides an overview.

**Table 3-13: Overview of the instrument boards, DIG I/Q interfaces and options**

Board	Connector	GUI designation	Required options
CODER	"DIG I/Q IN/OUT 1/2"	"CODER 1/2 In"	R&S SMW-B9 *) or R&S SMW-B10
FADER	"DIG I/Q IN/OUT 1/2"	"FADER 1/2/3/4 In/Out"	R&S SMW-B14 or R&S SMW-B15
BBMM	"DIG I/Q OUT 1/2"	"BBMM 1/2 Out"	R&S SMW-B13/-K18, R&S SMW-B13T/-K18 or R&S SMW-B13XT/-K19 *)

\*) also requires "System Config" > "Mode" = "Advanced".

A dedicated LED indicates the connector status:

- ● green: an input connector
- ● yellow: an output connector
- ● no light / gray: the connector is not active

For more information, refer to the specifications document.

### INST TRIG x

BNC connector for input of external trigger signals. The signals trigger sweeps and list mode.

See [Section 8.10.1, "Signal generation and triggering in the sweep and list modes"](#), on page 511.

### EXT 1/2

BNC connectors for input of external analog modulation signals.

Any of the two inputs can be used for path A and path B.

See [Section 8.11, "Analog modulations"](#), on page 546.

### LF OUT x

Option: R&S SMW-B13/-B13T

BNC connector for output of the internal LF generator signal.

**Note:** The output of the internal LF signal and the analog I/Q signal use the same physical connectors. Therefore, consider that you cannot assign both signals at the output simultaneously.

For more information, refer to the specifications document.

### **I/Q, I/Q Bar**

BNC connector for output of direct (single-ended) or differential analog I/Q signals.

**Note:** The R&S SMW200A also assigns the internal signal of the LF generator to the I output connector.

Therefore, consider that you cannot output the analog I/Q signal and the internal LF signal at the same physical connector simultaneously.

Use the connectors for connections as follows:

- I/Q connectors: Direct (single-ended) or positive differential output of analog I/Q signals
- I/Q Bar connectors: Negative differential output of analog I/Q signals

The number of connectors depends on the installed baseband options:

- Standard baseband (R&S SMW-B10 and R&S SMW-B13T)  
Two single-ended analog and two differential outputs.  
Output of differential signal requires option R&S SMW-K16.
- Wideband baseband (R&S SMW-B9 and R&S SMW-B13XT)  
Two single-ended analog or one differential output. Differential and single-ended signals cannot be output at the same time.  
Output of differential signal requires option R&S SMW-K17.

How to:

- ["To connect instruments to the I/Q analog interface"](#) on page 189
- ["To connect instruments to the I/Q digital interface"](#) on page 192

### **ADV DATA/CTRL**

Option: R&S SMW-B9/-B13XT and R&S SMW-K503/-K504

Interface for exchanging of external data and control signals.

See user manual R&S SMW-K501/-K502/-K503/-K504 Extended and Real-Time Sequencing, Real-Time Control Interface.

### **ADV TRG, ADV CLK**

Option: R&S SMW-B9/-B13XT

Input and output for synchronization signal in multi-instrument setups.

See also [Section 10, "Multi-instrument setups"](#), on page 663.

### **HS DIG I/Q**

Connectors for the input or output of high-speed digital I/Q signals, for example, from and to Rohde & Schwarz instruments.

The table below provides an overview.

**Table 3-14: Overview of the instrument boards, HS DIG I/Q connectors and options**

Board	Connector	GUI designation	Required options
CODER	"HS DIG I/Q IN/OUT 1/2"	"CODER 1/2 In"	R&S SMW-B9
FADER	"HS DIG I/Q IN/OUT 1/2"	"FADER 1/2/3/4 In/Out"	R&S SMW-B15
BBMM	"HS DIG I/Q IN/OUT 1/2"	"BBMM 1/2 Out"	R&S SMW-B13XT/-K19 *)

\*) for the output of digital I/Q signals.

The interface is a QSFP+ (Quad Small Form-factor Pluggable) module. It supports a maximum bandwidth of 50 Gsample/s with optical active cables.

How to: [Section 3.1.13, "Connecting to HS DIG I/Q"](#), on page 36

For more information, refer to the specifications document.

### 3.3 Trying out the instrument

This chapter provides step-by-step instructions to introduce the most important functions and settings of the R&S SMW200A.

These instructions are available as build-in tutorials, see the following:

- ["To start a tutorial in an interactive step-by-step mode"](#) on page 97

#### Prerequisites

- The R&S SMW200A is equipped with its base unit configuration.
- The R&S SMW200A is connected to the power supply and started up.  
See [Section 3.1.6, "Connecting to power"](#), on page 32.
- The R&S SMW200A has its default configuration after an instrument preset.  
See also ["Overview of the characteristics of the preset functions"](#) on page 702.

#### Base unit

The R&S SMW200A has the following options when equipped as a base unit:

- Standard baseband generator option R&S SMW-B10
- Baseband main module option R&S SMW-B13
- Frequency option R&S SMW-B1003

#### Instrument equipment and screenshots

In this description, the screenshots show a fully equipped instrument. Consider that some settings in the block diagram or in the configuration dialogs can differ from the settings of your instrument.

For the first signal generation tasks, you use the internal baseband and reference signal, so you do not need any additional signal source. More complex signal generation tasks require an instrument equipped with additional options or external signals.

The following sections provide introductory step-by-step instructions using the touchscreen. Each instruction lists the prerequisites to execute the instruction. Try out the following:

• <a href="#">Generating an unmodulated carrier</a> .....	54
• <a href="#">Generating a digitally modulated signal</a> .....	56
• <a href="#">Triggering the instrument externally</a> .....	57
• <a href="#">Working with marker signals</a> .....	62
• <a href="#">Routing a baseband signal to the outputs</a> .....	63
• <a href="#">Visualizing the generated signal</a> .....	67
• <a href="#">Saving and recalling settings</a> .....	70
• <a href="#">Generating an EUTRA/LTE signal</a> .....	72
• <a href="#">Enabling MIMO configuration</a> .....	75

### 3.3.1 Generating an unmodulated carrier

The step-by-step instructions in this section explain how to generate and measure an unmodulated RF continuous wave (CW) signal. The R&S SMW200A base unit generates an RF signal that is sufficient for generic RF receiver testing, for example for testing chipsets.

#### To generate a CW signal

1. Connect the RF A/RF B connector of the R&S SMW200A to the RF input connector of the DUT.  
See "[To connect to screwable connectors](#)" on page 34.
2. To check the generated signal, you can optionally connect a signal analyzer.  
See "[To connect to a signal analyzer](#)" on page 55.
3. Configure the RF signal:
  - a) In the status bar, select the "A Freq" field to enter a frequency value for the signal path A.
  - b) Using the on-screen keypad, enter for example *1.955g* to set a frequency value of 1.955 GHz.
  - c) Select the "Level" field to enter a level value.  
For example, enter *20* to set a level value of 20 dBm.

- In the block diagram, set the block "RF A" > "On" to enable the output of the generated RF signal.

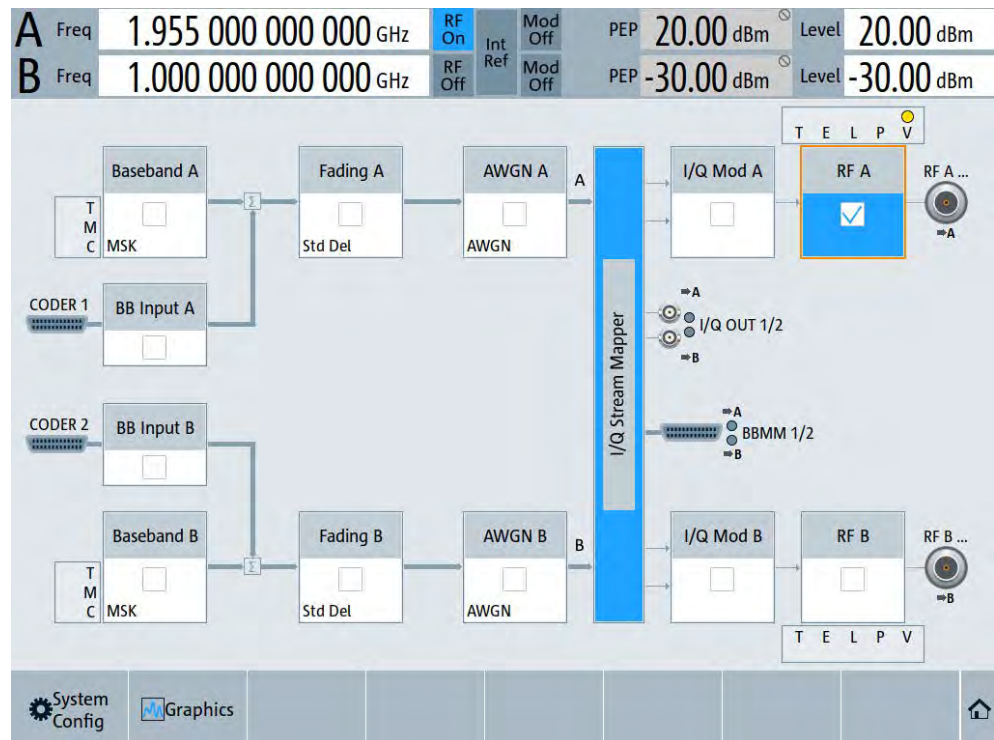

Figure 3-9: Block diagram with an unmodulated RF signal

The "RF A" connector on the front panel of the R&S SMW200A is output for the 1.955 GHz signal.

**To connect to a signal analyzer**

To display the generated CW, you can connect to a signal analyzer.

- ▶ Connect the "RF A" connector of the R&S SMW200A, for example to an FSW.

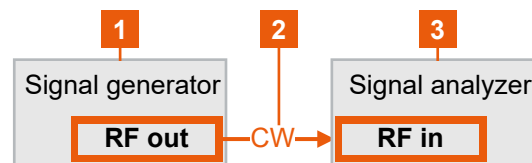

Figure 3-10: Test setup for measuring a CW

- 1 = Signal generator: R&S SMW200A
- 2 = RF output signal: CW signal
- 3 = Signal analyzer, for example the FSW

Table 3-15: Signal types and connections

Signal	Signal generator	Signal analyzer
RF (CW)	RF out: "RF A"	RF in: "RF INPUT 50 Ω"

For the required settings at the signal analyzer, refer to the documentation of the signal analyzer.

### 3.3.2 Generating a digitally modulated signal

This example shows you how to generate a simple WCDMA-3GPP (QPSK 45° offset) signal. The minimum requirement for R&S SMW200A in this example is a base unit.

The initial situation is not the instrument's preset state but rather the configuration described in [Section 3.3.1, "Generating an unmodulated carrier"](#), on page 54.

1. In the block diagram, select "Baseband A" to navigate to the section "Misc" > "Custom Digital Mod".

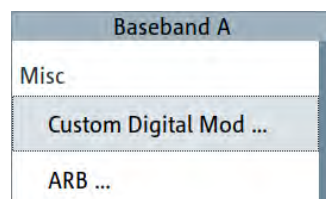

The "Custom Digital Modulation" dialog opens.

2. Select "General" > "Set according to Standard" > "WCDMA-3GPP".
3. Select "State" > "On" to enable baseband signal generation.

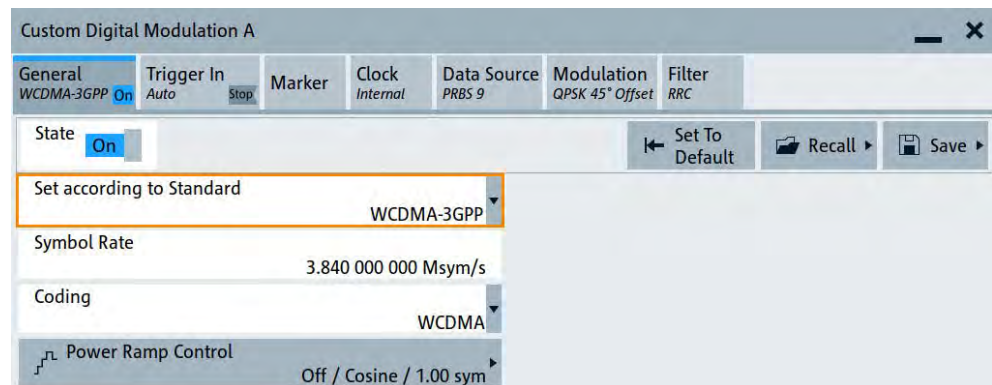

4. Select the "Modulation" tab to check the "Modulation Type".



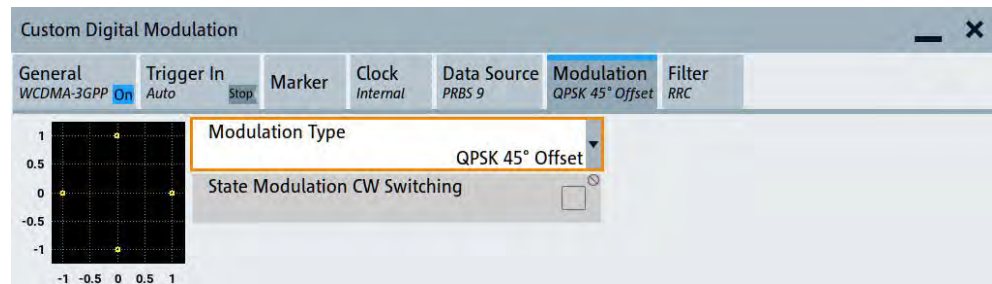

Figure 3-11: Modulation type of the WCDMA-3GPP signal

The instrument enables the I/Q modulator automatically ("I/Q Mod A" > "On"). Also, it uses an internal trigger signal and clock signal and generates the WCDMA-3GPP signal.

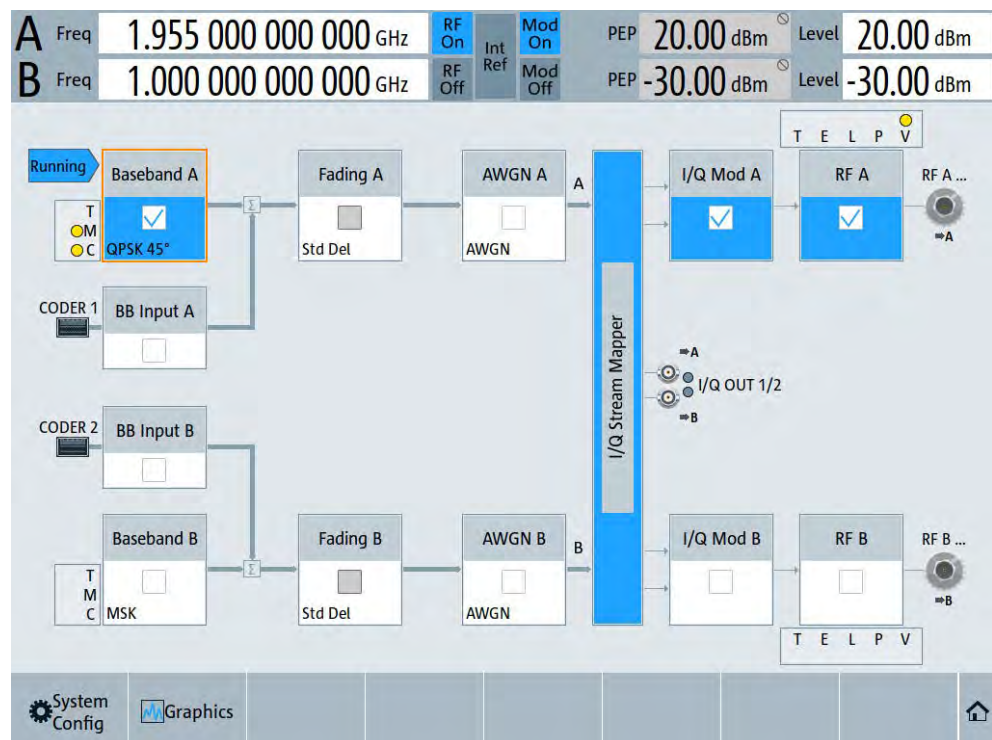

Figure 3-12: Block diagram: Generating a digitally modulated signal

### 3.3.3 Triggering the instrument externally

The example configurations are rather theoretical cases, because you rarely use the R&S SMW200A as a stand-alone instrument. Usually, you connect the instrument to a device under test (DUT) or other measurement equipment. As a rule, whenever a test setup requires two or more devices, provide them with a common reference frequency.

Some test setups require control of the signal generation start and an exact generation start time. A defined trigger event starts the signal generation, for example when triggering the instrument internally or externally from the DUT.

This example illustrates the general principle of external triggering and extends the configuration of [Section 3.3.2, "Generating a digitally modulated signal"](#), on page 56 by the configuration of the required trigger signal and connector settings. We use global "USER x" connectors. Alternatively, you can use the local connectors.

The test setup requires a signal analyzer, for example the FSW, as additional equipment.

### To trigger signal generation with an external global trigger

1. Define an input connector for the external global trigger signal.  
See ["To verify the current connector configuration"](#) on page 58
2. Configure "Baseband A" to use this external global trigger signal as the trigger source.  
See ["To reconfigure the trigger settings"](#) on page 59
3. Connect the instrument and the external trigger source.  
See ["To connect the instrument and the external trigger source"](#) on page 60

### To verify the current connector configuration

The R&S SMW200A is equipped with multipurpose bi-directional local T/M/C connectors and global USER connectors. Because the signal direction, input or output, and the signal mapping are configurable, we recommend that you check the current configuration before cabling or further instrument's configurations.

1. To display the current mapping of the logical signals to the connectors, select the "TMC" status LEDs on the left side of the "Baseband" block.



The "Trigger Marker Clock" dialog opens.

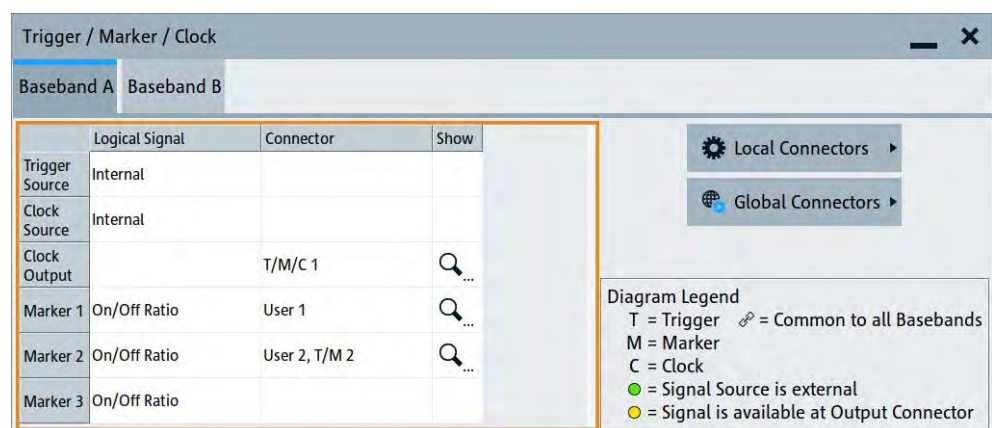

The instrument uses its internal trigger and clock signals, and the default mapping of the marker signals to the connectors.

2. To open the related connector settings, select "Global Connectors".

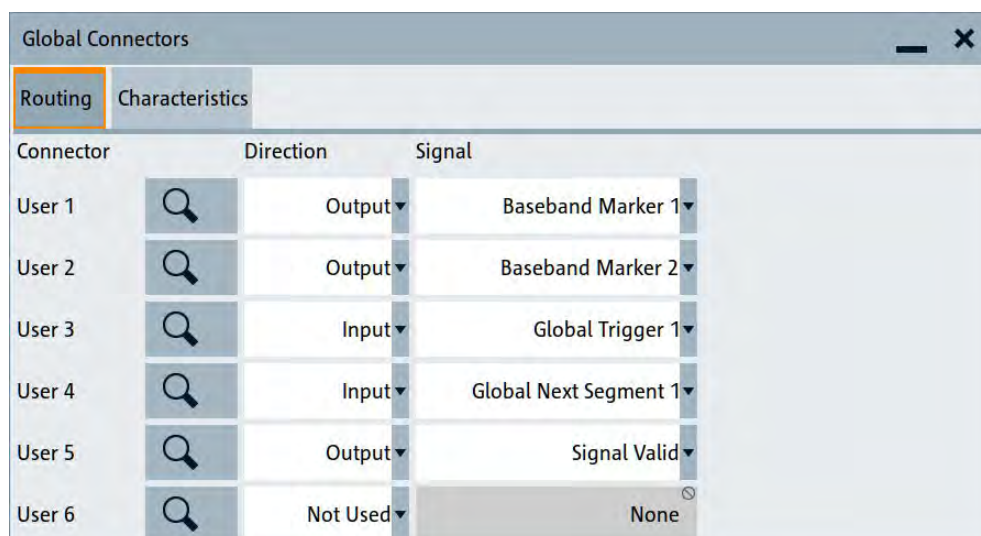

Connector	Direction	Signal
User 1	Output	Baseband Marker 1
User 2	Output	Baseband Marker 2
User 3	Input	Global Trigger 1
User 4	Input	Global Next Segment 1
User 5	Output	Signal Valid
User 6	Not Used	None

**Figure 3-13: Global connectors and signal mapping**

The "Global Connectors" dialog displays the current connector configuration. In this example we use the default signal mapping of the global connectors.

The three global connectors "USER 1" to "USER 3" are on the front panel and are mapped as follows:

- "USER 1" and "USER 2" connectors are output for the marker signals "Baseband Marker 1" and "Baseband Marker 2".
- The "USER 3" connector is an input for the trigger signal "Global Trigger 1".

Check the front panel of the R&S SMW200A. The LEDs next to the "USER 1" and "USER 2" connectors are yellow. The LED next to the "USER 3" connector is green.



#### To find the location of a connector

Use the built-in "Show" function to display the location of the selected connector. A blinking rectangle on the front panel or rear panel indicates the selected connector.

#### To reconfigure the trigger settings

We assume that the instrument generates a digital modulated signal, see [Section 3.3.2, "Generating a digitally modulated signal"](#), on page 56. Also we assume the default global connector mapping, see [Figure 3-13](#).

1. In the block diagram, select "Baseband" > "Misc" > "Custom Digital Mod".
2. Configure for an external trigger event:
  - a) Select "Trigger In" > "Mode" > "Armed Auto".
  - b) Select "Source" > "External Global Trigger 1".

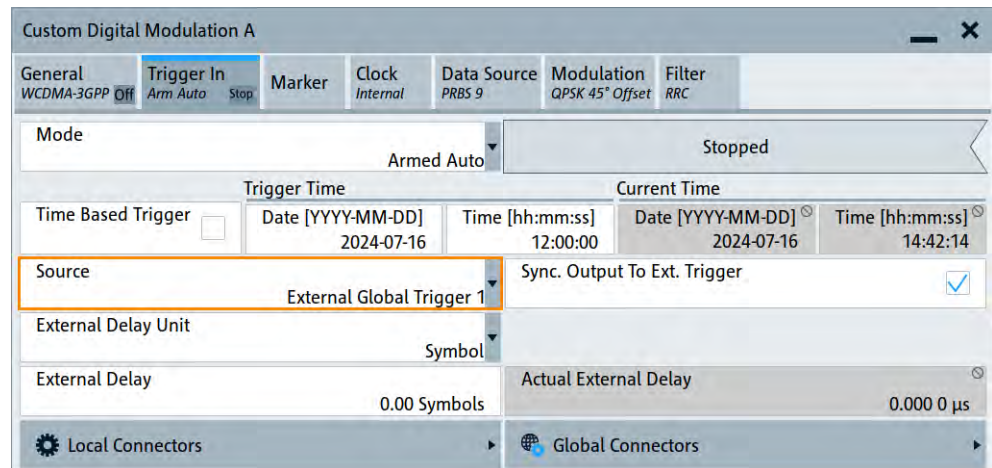

The instrument expects an external global trigger event. In the block diagram, the "TMC" status LED confirms that an external trigger signal is available that triggers the signal generation.

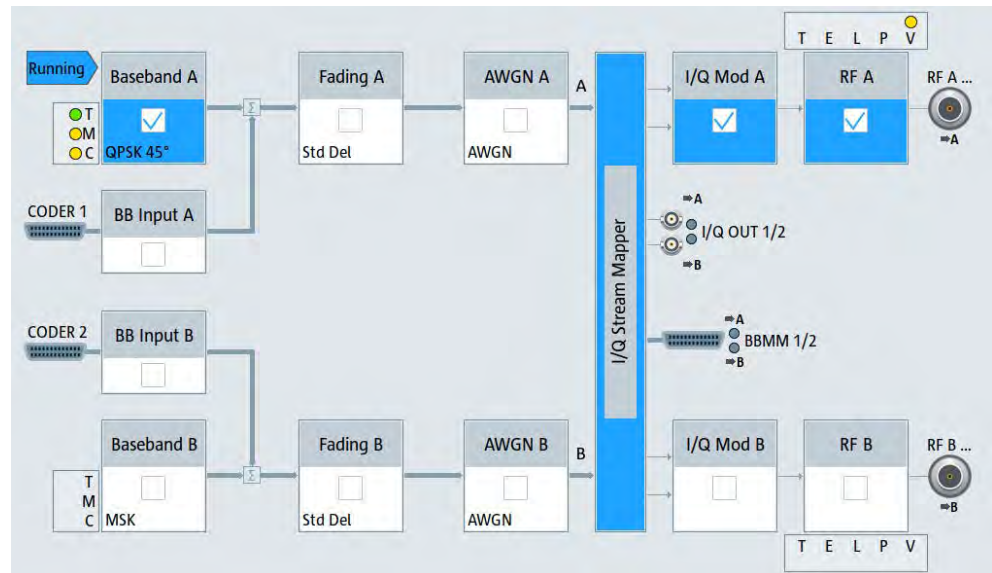

### To connect the instrument and the external trigger source

Use suitable cables for connection, see ["Cable selection to minimize electromagnetic interference \(EMI\)"](#) on page 31.

1. Connect the external trigger source to the "USER 3" connector of the R&S SMW200A and to the signal analyzer.

- Connect the output connectors for the RF signal and for the reference signal of the R&S SMW200A to the signal analyzer.

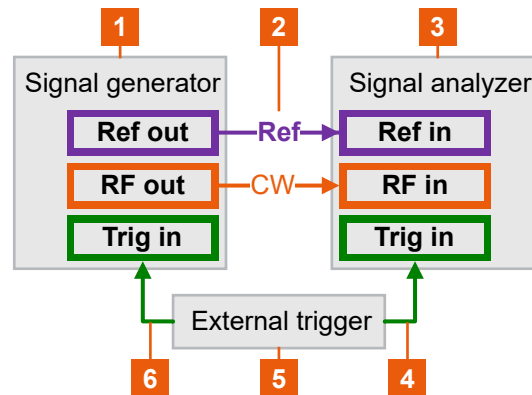

Figure 3-14: Test setup for external triggering

- 1 = Signal generator: R&S SMW200A
- 2 = Output signals: reference output signal and RF output signal
- 3 = Signal analyzer, for example the FSW
- 4, 6 = External trigger signal for the signal generator and signal analyzer
- 5 = External trigger source that provides an external trigger signal

Table 3-16: Signal types and connections

Signal	Signal generator	Signal analyzer
Reference	Ref out: "REF OUT"	Ref in: "REF INPUT"
RF	RF out: "RF A"	RF in: "RF INPUT 50 Ω"
Trigger	Trig in: "USER 3"	Trig in: "TRIGGER 1 INPUT"

In practice, the signal analyzer is the DUT, for example a base station. Also, the DUT can be the source for the reference signal. Instead of an external trigger source, the DUT can send, for example, a frame trigger signal to the R&S SMW200A. The R&S SMW200A remains the signal generation source.

### To generate an RF signal with an external trigger

- Set "Baseband A" > "On" to trigger signal generation.

If the R&S SMW200A receives the external trigger event, it starts continuous signal generation. Arming the trigger stops the signal generation until the next trigger event restarts the signal generation.

2. Select "RF A" > "On".

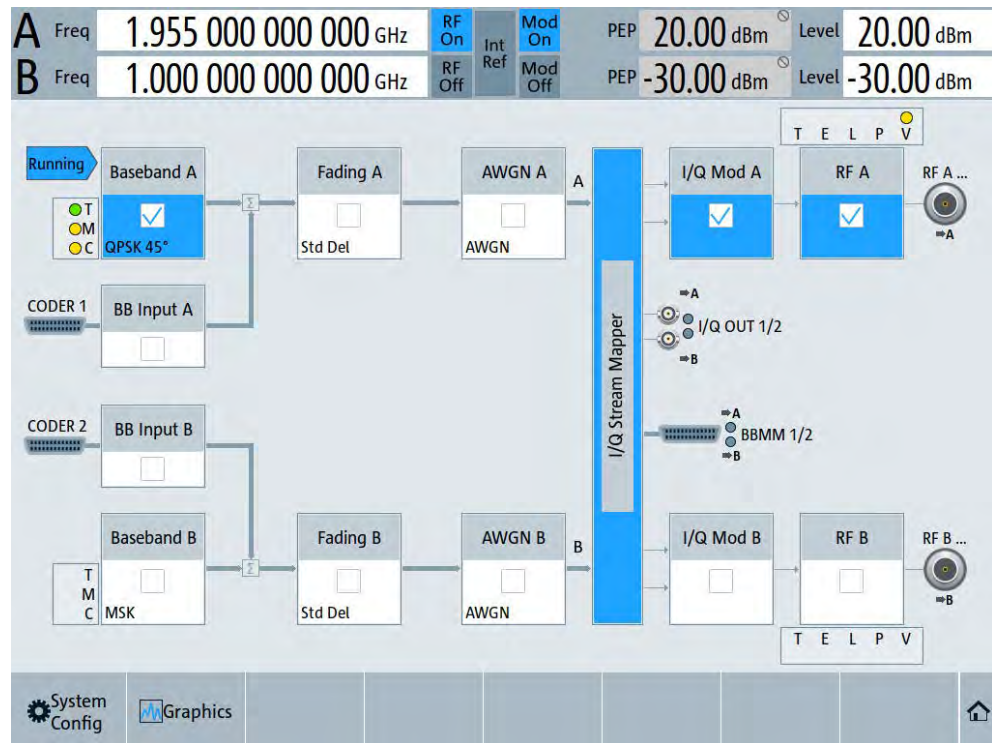

The R&S SMW200A generates the RF output signal and transmits the signal to the signal analyzer.

For more information see the following sections:

- [Section 5.5.1.5, "About trigger signals"](#), on page 235
- [Section 12.2, "Configuring local and global connectors"](#), on page 742

### 3.3.4 Working with marker signals

#### About marker signals

Test setups often require that an external device is synchronized to the generated data stream. For this purpose, the R&S SMW200A provides marker output signals also additional to the generated signal. There are several generic marker signals and specific marker signals of a firmware option. With suitable marker settings for instance, you can mark slot or frame boundaries or mark the start of a particular modulation symbol.

### To connect an oscilloscope

You can monitor marker output signals, for example with an oscilloscope like the R&S RTO. Use suitable cables for connection, see ["Cable selection to minimize electromagnetic interference \(EMI\)"](#) on page 31.

1. Connect the "USER 1" connector of the R&S SMW200A to the oscilloscope.
2. Connect the "I" connector of the R&S SMW200A to the oscilloscope.

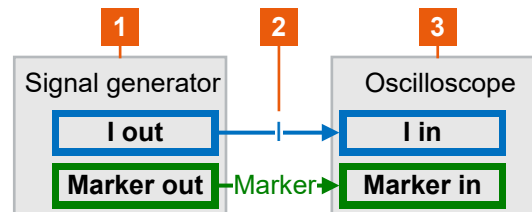

**Figure 3-15: Test setup for a marker and I output signal**

- 1 = Signal generator: R&S SMW200A  
 2 = Output signals: I-component of the I/Q output signal and marker output signal  
 3 = Oscilloscope, for example the R&S RTO

**Table 3-17: Signal types and connections**

Signal	Signal generator	Oscilloscope
I (I/Q signal component)	I out: "I"	I in: "Ch 2"
Marker	Marker out: "USER 1"	Marker in: "Ch 3"

### To configure the marker output signal

This step-by-step instruction uses a digital baseband signal and the default global connector mapping. See [Section 3.3.2, "Generating a digitally modulated signal"](#), on page 56 and see [Figure 3-13](#).

1. In the block diagram, select "Baseband" > "Misc" > "Custom Digital Mod".
2. Configure a periodic marker signal for marker 1:
  - a) Select "Marker" > "Marker 1" > "Mode" > "Pulse".
  - b) Select "Divider" = "32".

The instrument generates a periodic marker signal with a frequency of 120 kHz.  
 The instrument outputs the signal at the "USER 1" connector.

For more information, see [Section 5.5.1.4, "About marker signals"](#), on page 231.

## 3.3.5 Routing a baseband signal to the outputs

This section emphasizes on the signal routing capabilities in the default state of the instrument (standard system configuration mode). The R&S SMW200A provides the "I/Q Stream Mapper" function to route and distribute each of the generated I/Q signals (streams) to any of the available output connectors.

In the provided example, you use the R&S SMW200A to generate two baseband signals, apply a baseband frequency shift, weight them and add them. You then route the generated stream and define the output connector. The initial situation is the configuration described in [Section 3.3.3, "Triggering the instrument externally"](#), on page 57.

The minimum requirement for the instrument in this example is an R&S SMW200A equipped with the options 2xR&S SMW-B10, R&S SMW-B13T, and R&S SMW-B1003/-B2003.

### To configure a composed baseband signal

1. In the first baseband, generate a WCDMA-3GPP signal as described in [Section 3.3.2, "Generating a digitally modulated signal"](#), on page 56.
2. Route the signal from "Baseband B" block to the first signal path:
  - a) In the block diagram, select "Baseband B" block.
  - b) Drag&drop this block to the first path, for example the "Fading A" block or "AWGN A" block depending on the options installed on your instrument.

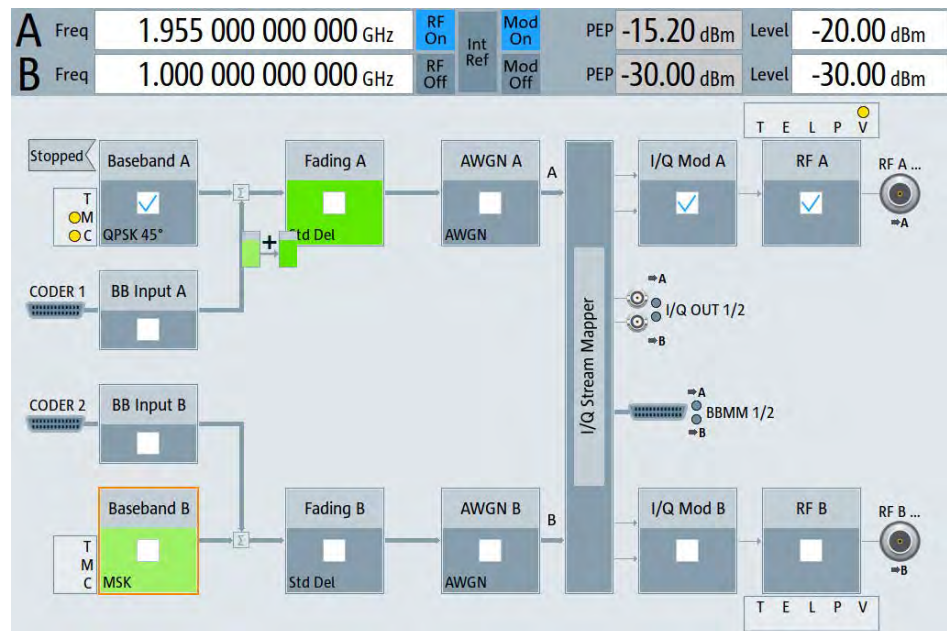

- c) Select the "Fading B" block to drag&drop it to the "Baseband B" block. The block diagram rearranges and updates the signal routing.



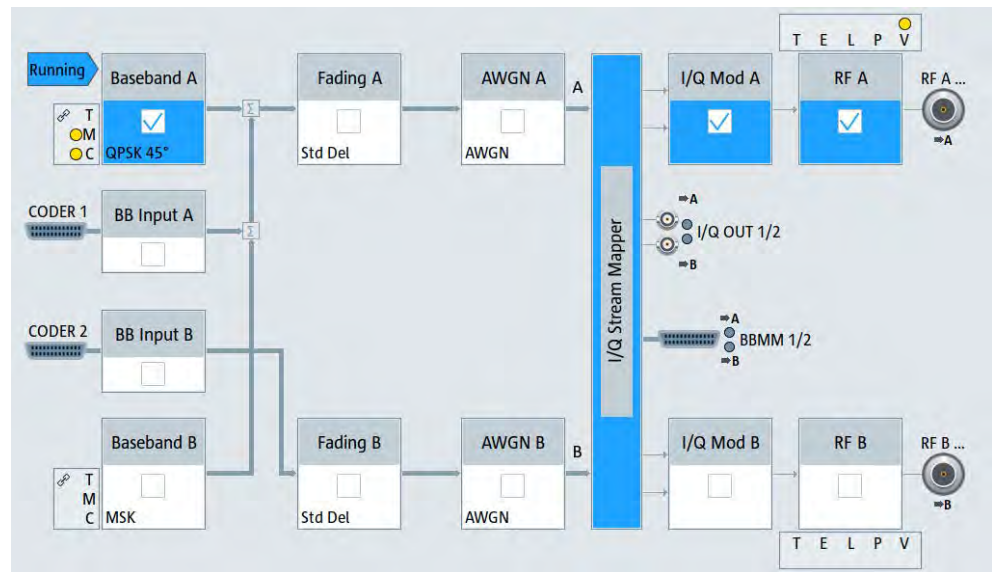

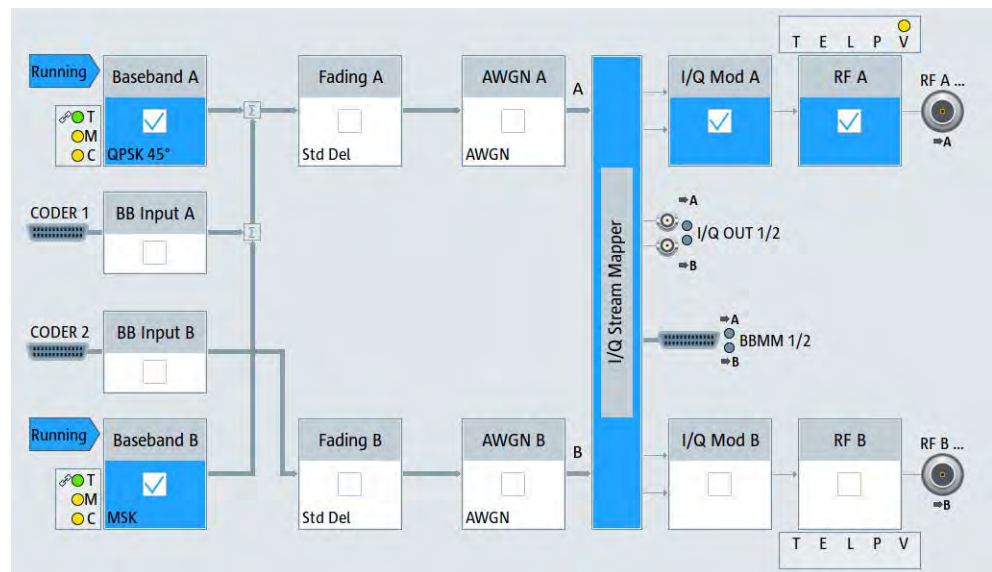

3. Configure the baseband signal for path B:
  - a) Select "Baseband B" > "Misc" > "Custom Digital Mod".
  - b) Select "General" > "Set according to Standard" > "WCDMA-3GPP".
  - c) Set "State" > "On" to enable signal generation of the baseband signal in path B.



4. Apply frequency offsets and power offsets to the baseband signals:
  - a) Select "Baseband B" > "Baseband Offsets".
  - b) Enter "Baseband A" > "Frequency Offset" = "-5 MHz".
  - c) Enter "Baseband B" > "Frequency Offset" = "5 MHz".
  - d) Enter "Baseband B" > "Gain" = "-30 dB".
  - e) Close the "Baseband Offsets" dialog.

	Frequency Offset (Hz)	Phase Offset (deg)	Gain (dB)
Baseband A	-5 000 000.00	0.00	0.000
BB Input A	0.00	0.00	0.000
BB Input B	0.00	0.00	0.000
Baseband B	5 000 000.00	0.00	-30.000

In the block diagram, symbols to the right of the baseband blocks indicate enabled baseband offsets:

- For an enabled frequency offset: 
- For an enabled frequency offset and path gain: 

Also, the R&S SMW200A couples the trigger settings in both basebands. The trigger settings in "Baseband A" apply automatically to the "Baseband B".

The "TMC" block indicates the coupling: 

### To map the I/Q stream to the output connector

The term stream describes the signal at the input of the "I/Q Stream Mapper" up to the output connectors of the instrument.

1. In the block diagram, select the "I/Q Stream Mapper" block.

The tab displays the distribution and the mapping of the I/Q streams to the output connectors as a mapping matrix.

System Configuration								
Multi Instrument Fading/Baseband Config I/Q Stream Mapper External RF and I/Q Overview								
	Frequency Offs (Hz)	Phase Offs (°)	RF A	RF B	I/Q OUT 1	I/Q OUT 2	BBMM 1	BBMM 2
Stream A	0.00	0.00	✓		✓		✓	
Stream B	0.00	0.00		✓		✓		✓
Combination			Single	Single	Single	Single	Single	Single

Stream A is routed to all the available output connectors: the analog RF A and I/Q ("I/Q OUT 1") connectors, and the digital I/Q output connectors DIG I/Q ("BBMM1").

2. To reconfigure the mapping, tap a matrix entry, for example disable the output of stream A on the BBMM 1 interface.

With the I/Q stream mapper, you can route the streams to the outputs. Note that routing does not enable the output states. Enable them separately, for example, in the block diagram.

3. Optionally, open the settings of the input and output interfaces:

- a) In the block diagram, unfold the blocks of the input interfaces and output interfaces.

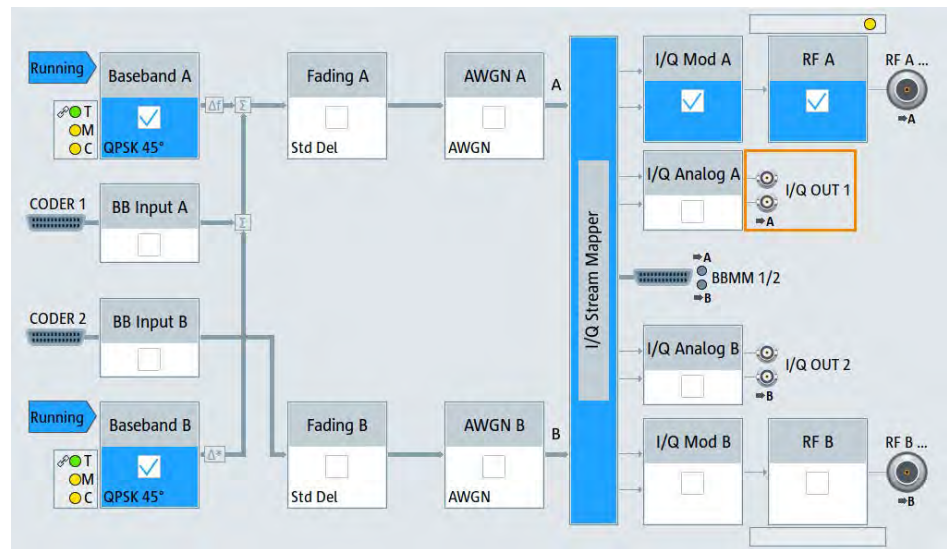

- b) If your block diagram does not show a block, tap the corresponding RF connector icon.  
For example, tap the "I/Q Out 1" icons to unfold the "I/Q Analog A" block.
- c) To open the related settings, tap the block.

The generated composed signal (stream A) is output at the analog "RF A" connector and routed to the "I/Q Out 1" connector. The block diagram confirms this routing and displays "A" next to the symbols of the output connectors. Also, consider that the I/Q connectors are disabled.

For more information, see [Section 4, "Signal routing and system configuration"](#), on page 100.

### 3.3.6 Visualizing the generated signal

You can visualize the generated signal graphically, before you enable the RF output of the instrument. The R&S SMW200A provides a build-in function to represent the generated signal on a graphical signal display. We demonstrate this feature by showing the characteristics at one particular point of the signal processing chain. You can, however, display the signal characteristics at other different stages.

This step-by-step instruction shows how to use the graphical display to verify the generated signal. We use the generated signal as described in [Section 3.3.5, "Routing a baseband signal to the outputs"](#), on page 63.

#### To open the graphics dialog

- ▶ On the taskbar, select the graphics icon.



The "Graphics Configuration" dialog opens.

### To visualize the sum signal

1. In the "Graphics Configuration" dialog, select "Mode" > "Power Spectrum".
2. Select "Source" > "A Stream".
3. Select "Add" to enable signal display.

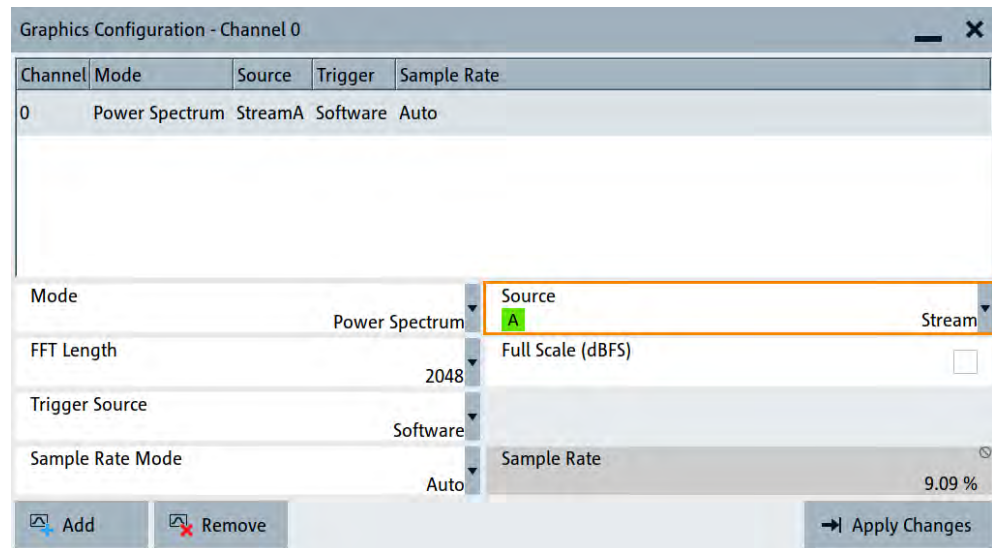

A new thumbnail appears in the taskbar and displays the power spectrum.



4. Press the thumbnail graphic.  
The graphic enlarges and the diagram is displayed in a normal size.  
The "Power Spectrum" displays two signals, both WCDMA-3GPP signals are frequency shifted and the right one is also attenuated.
5. Zoom into the spectrum. The zoom in function works like the two-finger pinching for magnifying images on your mobile phone.
6. Select "Show Marker" to measure the distance between the two signals.

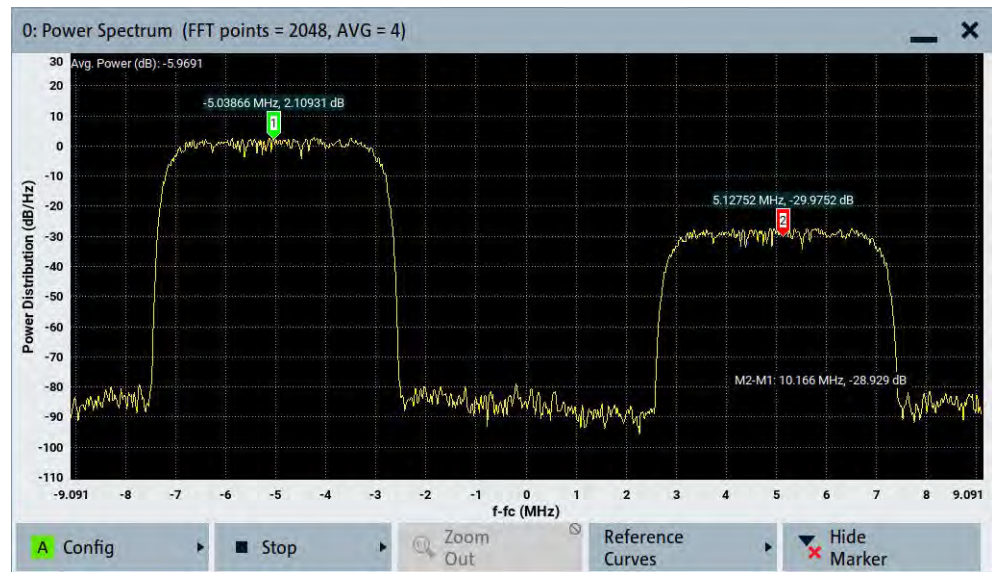

7. Select "Config" to return to the "Graphics Configuration" dialog.

You can close the dialog. Closing the dialog has no effect on the configured graphics but on the dialog itself.

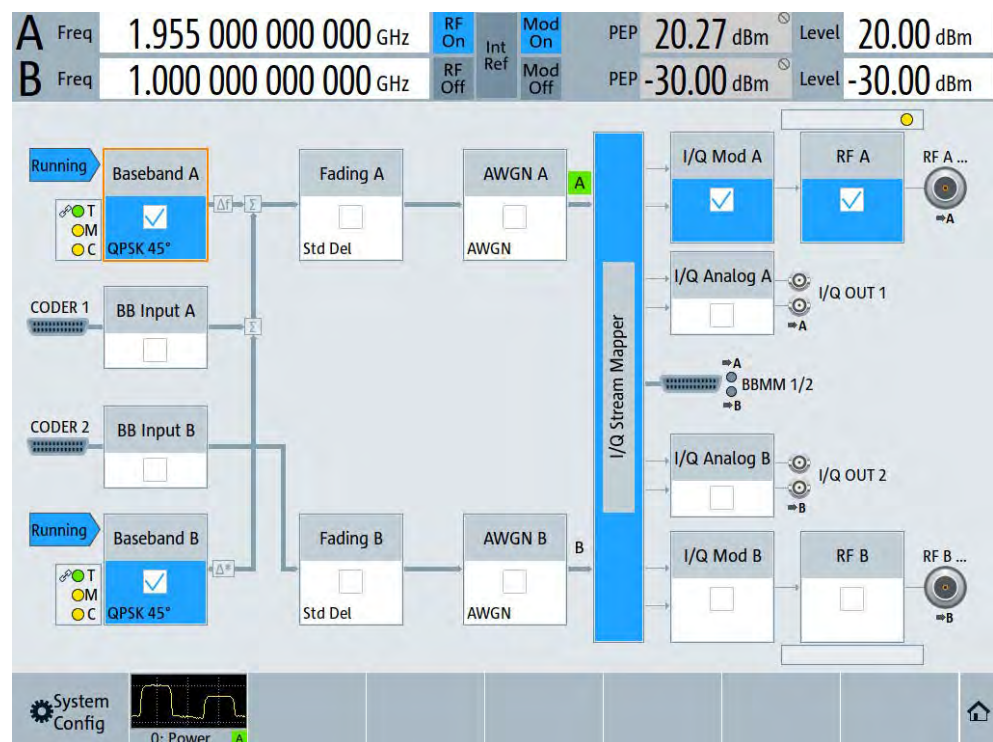

The block diagram displays the current signal routing. It indicates that frequency and power offsets are enabled and displays the acquisition points for the real-time diagrams minimized in the taskbar.

For more information, see [Section 9, "Monitoring signal characteristics"](#), on page 622.

### 3.3.7 Saving and recalling settings

To restore the results of our measurements later, we saved the instrument settings to a file.

#### To save instrument settings to a file

We assume a test configuration as described in [Section 3.3.5, "Routing a baseband signal to the outputs"](#), on page 63.

1. Press the [SAVE/RCL] key on the front panel.
2. In the "Save/Recall" dialog, save the settings of the test configuration:
  - a) Select "Operation Mode" > "Save".
  - b) Use the on-screen keyboard to enter *MyTestSignal* for the "File Name".

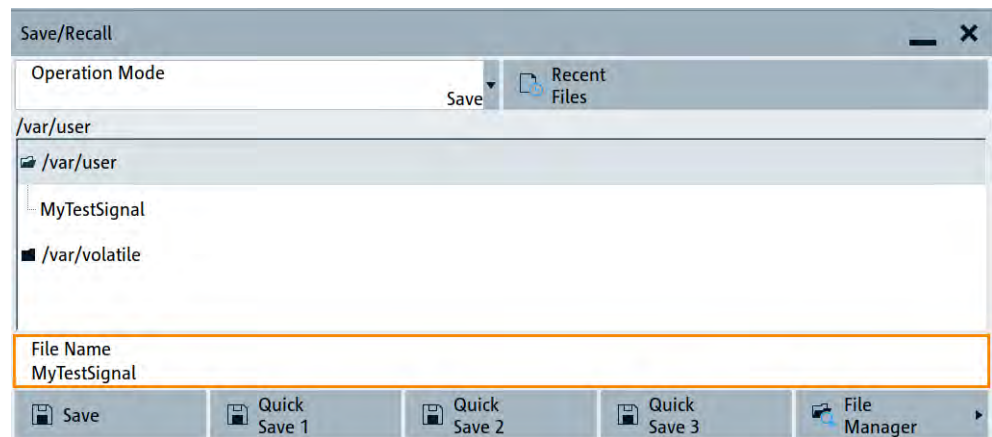

3. Tap the "Save" button.

The instrument saves the settings in the file `MyTestSignal.savrcltxt` to the default directory `/var/user`.

#### To load saved instrument settings

You can restore the settings to the instrument at any time using the settings file.

1. Press the [PRESET] button to restore the default instrument settings.
2. Press the [SAVE/RCL] key.
3. In the "Save/Recall" dialog, select "Recall" operation.
4. Select the file `MyTestSignal` in the directory.

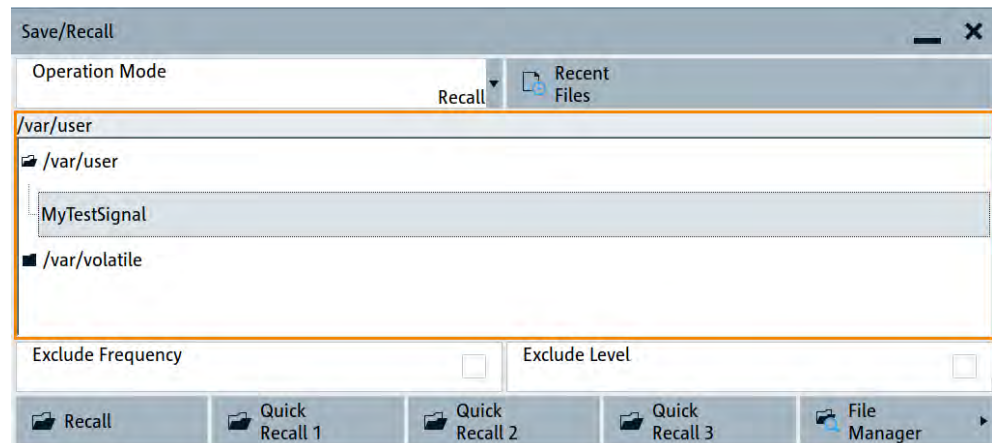

5. Tap the "Recall" button.

All instrument settings are restored.

### To display variations from preset values

When you load a file to your instrument, you can mark the changed settings. The user interface can visualize all parameters that differ from their default state.

1. Tap and hold on an empty space in the block diagram to open the context-sensitive menu.
2. Select "Mark All Parameters Changed from Preset".

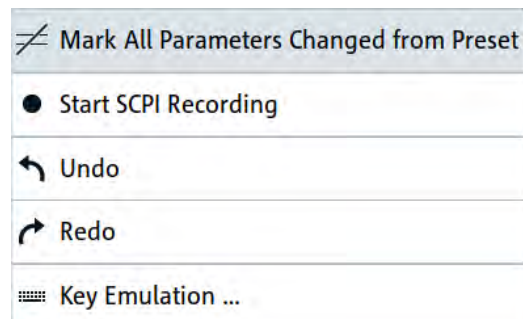

All changed parameters are highlighted.

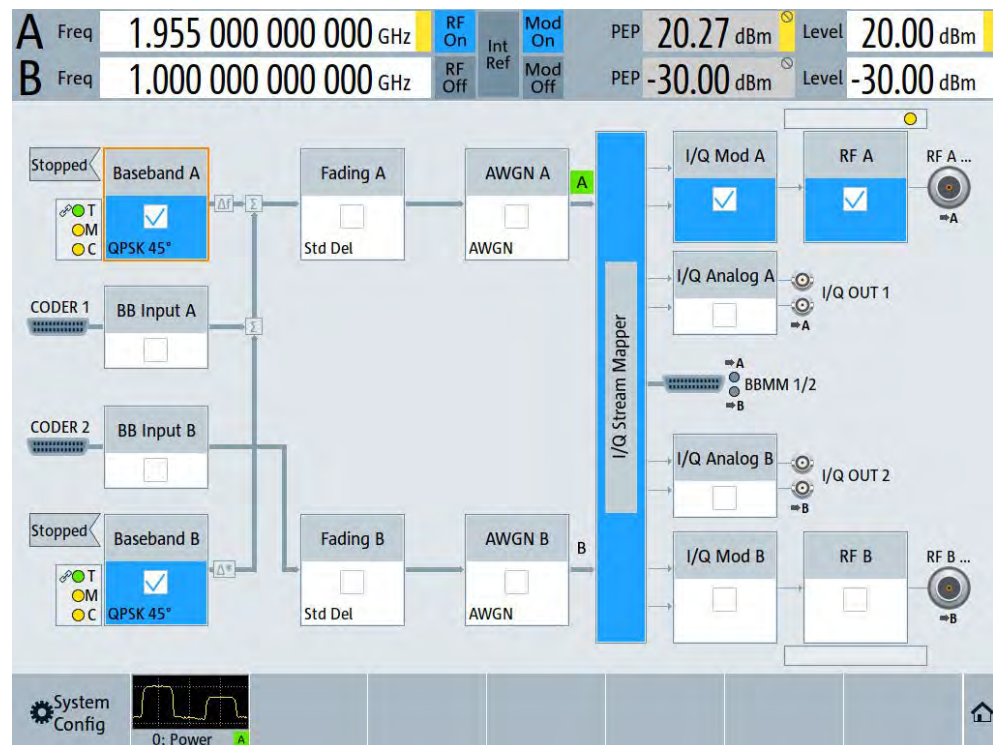

### 3.3.8 Generating an EUTRA/LTE signal

The main application field of the R&S SMW200A is the generation of digital signals in accordance with several telecommunication and wireless standards, like WCDMA, EUTRA/LTE or WLAN, to name a few. This example uses the digital standard EUTRA/LTE to introduce the way you can access and interact with the instrument and experience the advantages provided by the additional options.

The minimum requirement for R&S SMW200A in this example is a base unit equipped with the additional option R&S SMW-K55 EUTRA/LTE.

#### To generate a downlink test signal

The main focus of the following example is not on the R&S SMW200A capabilities and the features provided by the firmware option. The example aims rather to help you get familiar with the settings and configuration principles that are common for the digital standards.

We use one of the provided EUTRA test models (E-TM) to show how to generate a test signal upon a quick selection.

1. On the R&S SMW200A front panel, press the [PRESET] key to start out in a defined instrument configuration.
2. In the block diagram, select "Baseband" > "EUTRA/LTE".



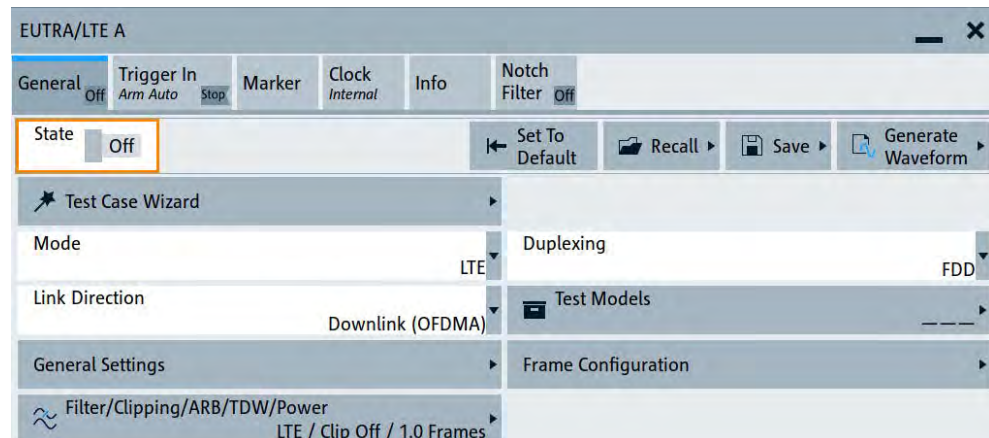

As in the user interfaces of all digital standards, the "EUTRA/LTE" dialog is divided into several tabs. The "General" tab provides general LTE settings and saving and recalling settings. Also, it provides functions to open further dialogs, for example, the baseband filter settings. The "Trigger In", "Marker" and "Clock" tabs provide settings to configure these functions.

More complex digital standard configurations provide a more complex dialog and tab structure. For all digital standards the dialog structure at the beginning has the following tabs: "General", "Trigger In", "Marker" and "Clock".

**Tip:** To display the dialog in its maximal height, press the [RESIZE WINDOW] key on the front panel.

3. In the "General" tab, select "Test Models".

The test models conform with various EUTRA test models (E-TM). A standard "File Select" dialog enables you to select from a list of files with predefined settings.

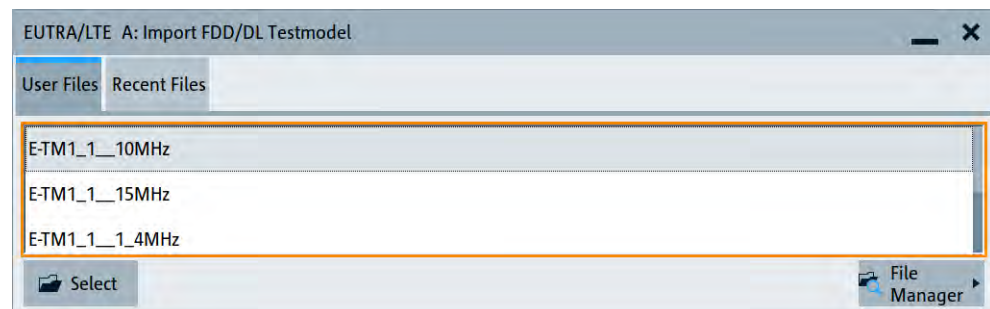

**Tip:** On the front panel, press the [HELP] key to obtain detailed information on the contents of the predefined files.

4. Navigate to a file, for example to the file E-TM1\_1\_\_10MHz.

The file uses an E-TM1.1 test model with 10 MHz channel bandwidth.

5. Confirm with "Select".

The dialog closes and the "Test Models" button displays "E-TM1\_1\_\_10MHz".

6. Set "State" > "On" to enable baseband signal generation.

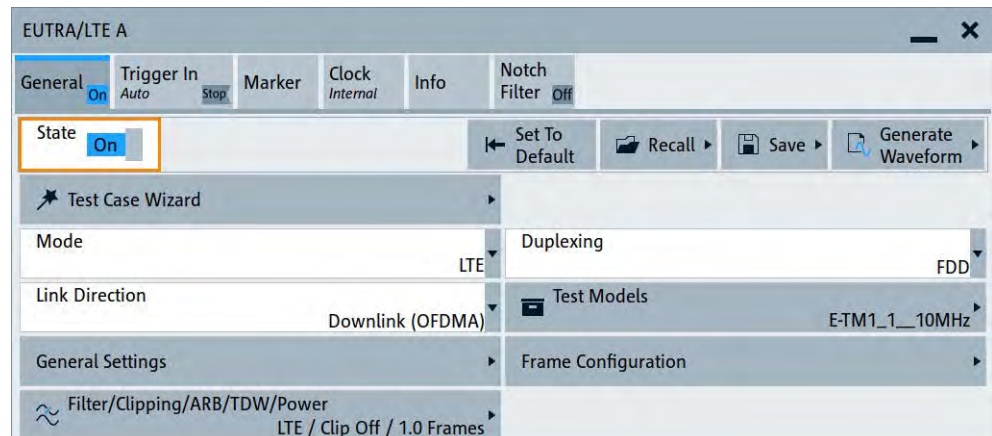

7. On the status bar, set the "Freq" = "2.143 GHz".
8. Set "Lev" = "-20 dBm"
9. Set "RF A" > "On" to enable RF signal generation.

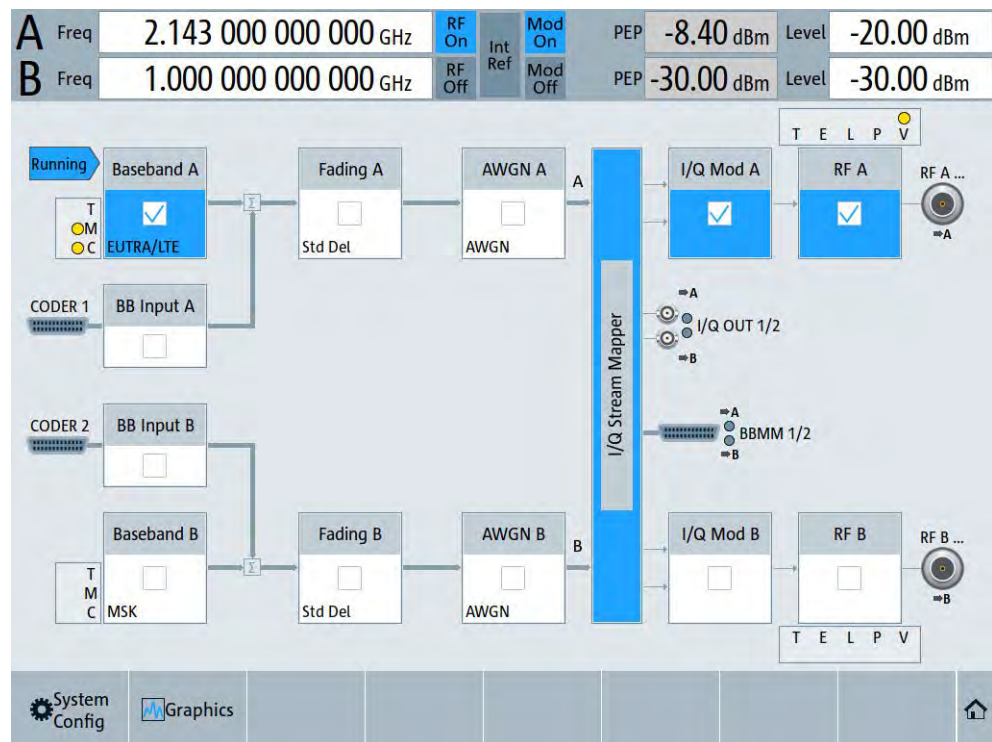

The instrument generates an EUTRA/LTE test signal with the configured channel bandwidth, frequency and level.

For more information, see the "R&S SMW200A EUTRA/LTE" user manual.

### 3.3.9 Enabling MIMO configuration

The R&S SMW200A supports versatile MIMO configurations and provides comfortable functions to simplify the definition and signal routing for MIMO test setups and configuration involving several instruments. For complex routing scenarios, the "System Configuration" dialog is the start and central configuration point.

Within this dialog, you can configure complex configurations with up to 8 TX antennas or 8 RX antennas. Also, you can configure up to two stand-alone 2x2 MIMO systems, for example 8x2 MIMO or an LTE-A carrier aggregation with 2x2 MIMO.

This example does not cover the whole range of the "System Configuration" capabilities but delivers an insight into the topic. The example shows how to use coupled baseband sources and select a suitable fading and baseband configuration to generate an EUTRA/LTE signal in 2x2 MIMO configuration.

In this example, the R&S SMW200A is equipped with two signal paths:

- Two options R&S SMW-B10 and one option R&S SMW-B13T
- Two options R&S SMW-B14 and one option R&S SMW-K74
- Two frequency options, for example R&S SMW-B1003/-B2003
- Two options R&S SMW-K55 EUTRA/LTE

#### To open the system configuration dialog

1. On the taskbar, select "System Config" > "System Configuration"

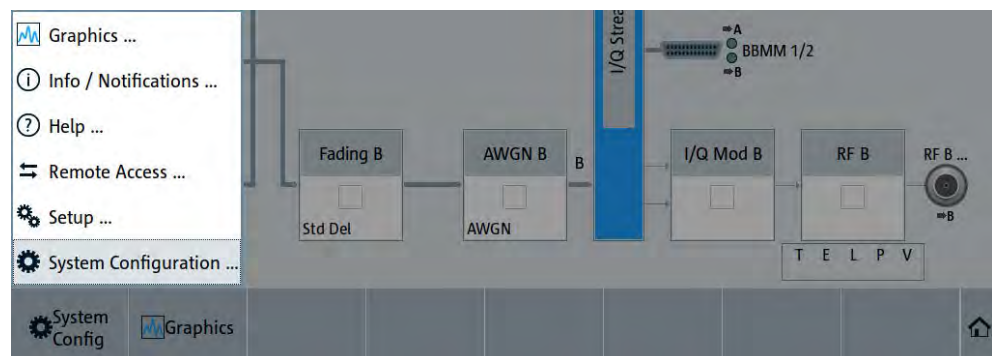

The "Fading/Baseband Config" tab displays the current signal routing. By default, the instrument uses the "Standard" mode.

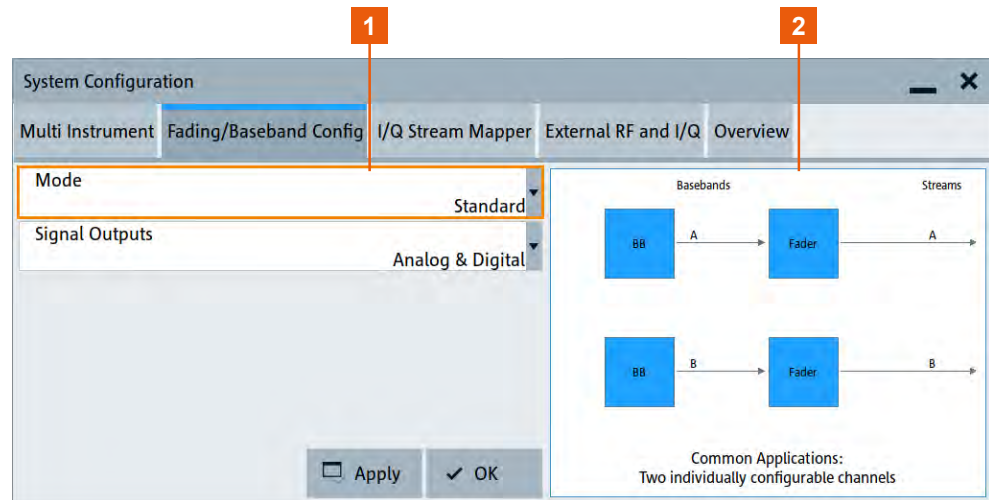

**Figure 3-16: Standard mode system configuration**

1 = Standard for simple signaling scenarios

2 = Preview diagram of the particular system configuration

2. Select "I/Q Stream Mapper" to obtain an overview of the current distribution and mapping of the I/Q streams to the output connectors.  
See also ["To map the I/Q stream to the output connector"](#) on page 66.
3. Select "External RF and I/Q" to gain information on the current setup.  
The tab provides additional settings to simplify the configuration of connected instruments. These settings allow you to configure the connectors, to establish a connection to the instruments or to control these instruments.  
In this test setup, no further instruments are connected.

For more information, see [Section 4, "Signal routing and system configuration"](#), on page 100.

#### To enable a 2x2 MIMO configuration

1. Select "System Configuration" > "Fading/Baseband Config".
2. Configure an advanced 1x2x2 configuration:
  - a) Select "Mode" > "Advanced".
  - b) Select "Entities (Users, Cells)" > "1".
  - c) Select "Basebands (Tx Antennas)" > "2".
  - d) Select "Streams (Rx Antennas)" > "2"
  - e) Select "BB Source Config" > "Coupled Sources"
  - f) Optionally, observe the signal routing in the preview diagram to the right to check if it matches your expectation.
  - g) Select "Apply" to confirm the configuration.

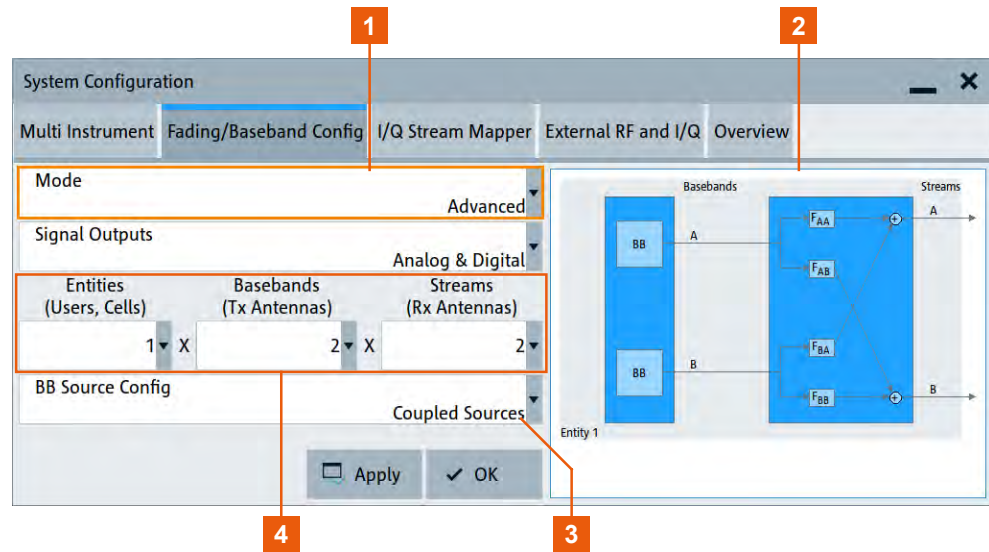
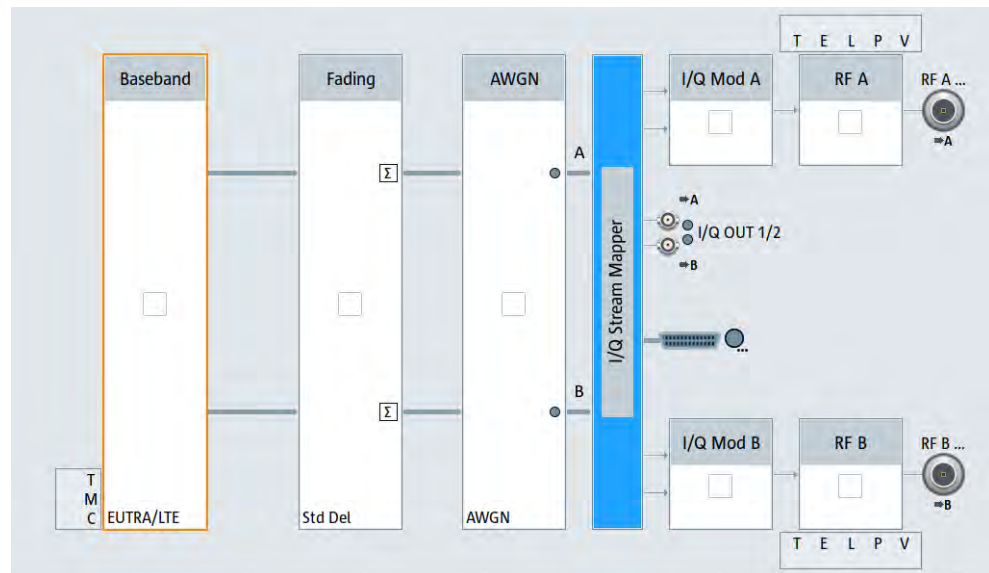

**Figure 3-17: Advanced mode system configuration (1x2x2 MIMO)**

- 1 = Advanced mode for complex  $L \times M \times N$  MIMO scenarios
- 2 = Preview diagram of the particular system configuration
- 3 = Separated or coupled baseband sources
- 4 = Current signal routing for a 2x2 MIMO configuration

You can leave the "I/Q Stream Mapper" settings at their default values.

3. Close the "System Configuration" dialog.



The block diagram displays the selected configuration.

### To generate a 2x2 MIMO EUTRA/LTE signal

1. In the block diagram, select "Baseband" > "EUTRA/LTE"
2. Set "State" > "On" to enable baseband signal generation.

In coupled baseband source mode, the R&S SMW200A takes over the baseband signal configuration. The instrument adjusts the settings in the basebands automatically, for example the mapping of the transmit antennas to the basebands.

3. In the block diagram, set "Fading" > "On".  
The instrument uses the default fading profile "Standard Delay".
4. On the status bar, set the same frequency and level settings for both paths:
  - a) "A Freq" = "B Freq" = "2.143 GHz"
  - b) "Lev (A)" = "Lev (B)" = "-20 dBm"
5. In the block diagram, select "RF A" > "On" and "RF B" > "On".

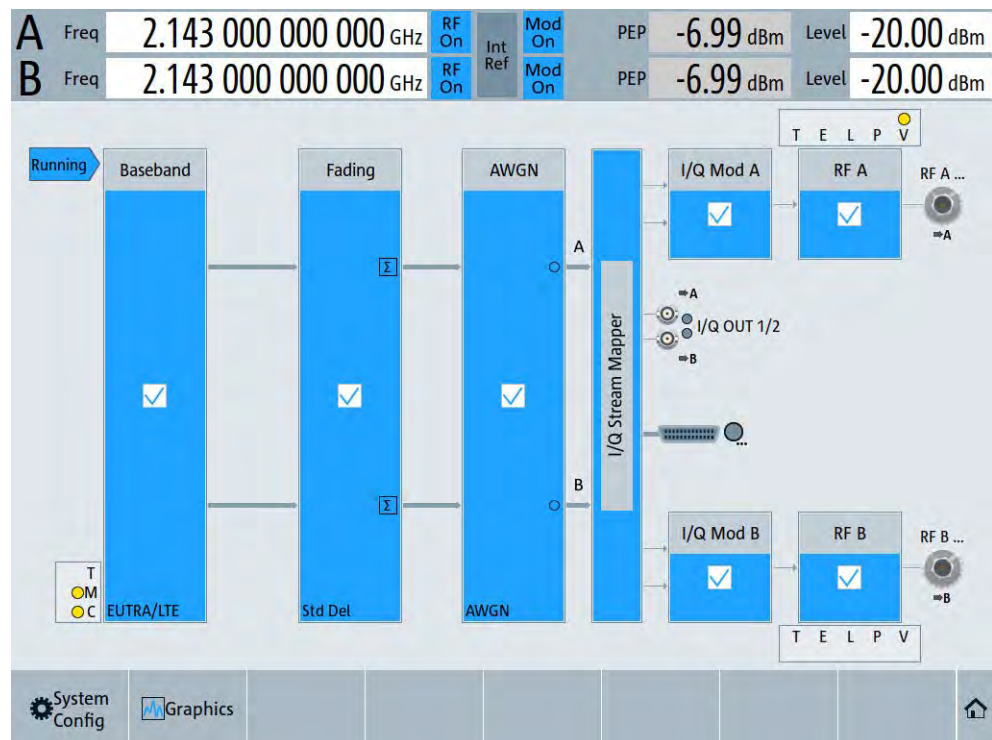

The R&S SMW200A generates a realistic EUTRA/LTE downlink signal with 10 MHz channel bandwidth but without any scheduled data.

For more information, see the "R&S SMW200A EUTRA/LTE" user manual.

### 3.4 System overview

This section helps you to get familiar with the R&S SMW200A. It provides an introduction to the general concept of the instrument with a sample of the possible application fields. This section also introduces the main blocks in the signal generation flow.

For information on how to access functions and interact with the R&S SMW200A, see [Section 3.5, "Operating the instrument"](#), on page 86.

### 3.4.1 Brief concept of the instrument

The R&S SMW200A combines up to two independent signal generators in one instrument and offers unrivaled RF and baseband characteristics. Due to its modularity, the instrument can be optimally adapted to the requirements of different applications. Both RF paths can be equipped with one of the available frequency options with different upper frequency limit. The baseband section of the R&S SMW200A is fully digital. It contains the hardware for generating and processing real-time I/Q signals or generating signals with an arbitrary waveform generator.

#### 3.4.1.1 Signal flow at a glance

The R&S SMW200A is equipped with a large touchscreen that displays a block diagram. The block diagram represents the signal flow and the general stages that the signal generation goes through. Depending on the options the R&S SMW200A is equipped with, the appearance of the block diagram changes.

The following examples do not cover all possible cases but aim to introduce the way the block diagram depicts the installed options.

- An example of a fully equipped wideband baseband instrument (2xR&S SMW-B9, R&S SMW-B13X, 4xR&S SMW-B15, R&S SMW-B1044/-B2044)

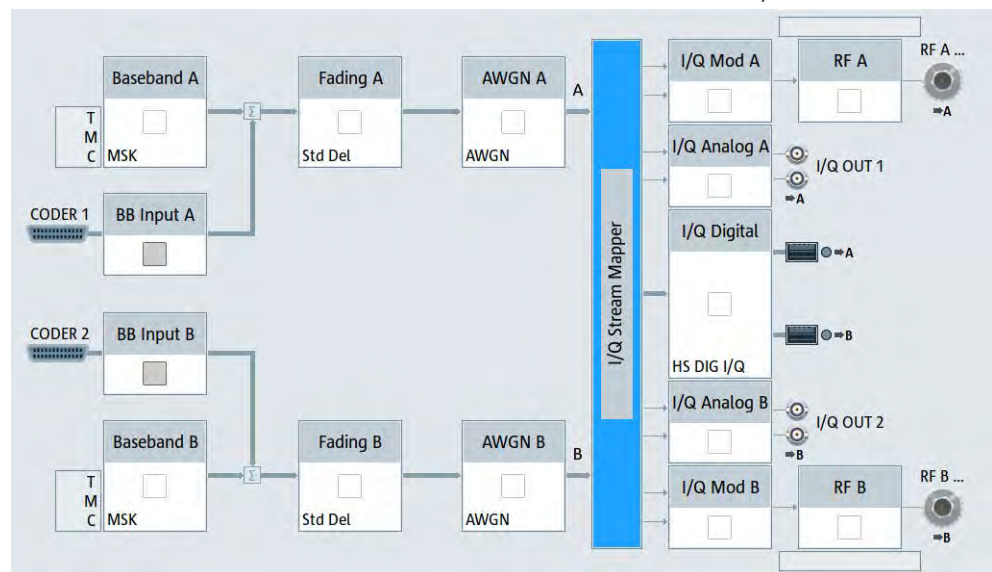

- An example of a base unit, equipped with one signal path (R&S SMW-B10, R&S SMW-B13, and R&S SMW-B1003)

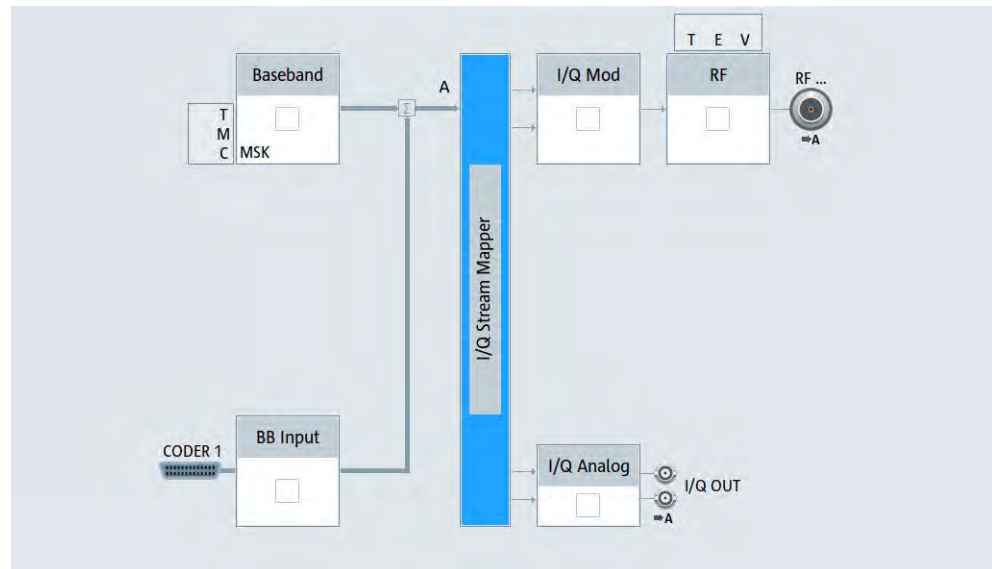

For more examples, see also [Section 3.4.2, "Applications examples of the R&S SMW200A"](#), on page 82.

### Installed options and displayed settings

The table [Table 3-18](#) lists the options to display a functional block in the block diagram for a standard baseband generator R&S SMW-B10 and R&S SMW-B13T.

**Table 3-18: Functional block and required options per functional block (excerpt)**

Functional block	Required option
"Baseband A", "Baseband B"	One or two options R&S SMW-B10
"BB Input A", "BB Input B"	One or two options R&S SMW-B10
"Fading A", "Fading B"	One or two options R&S SMW-B14
"AWGN A", "AWGN B"	One or two options R&S SMW-K62
"I/Q Stream Mapper"	-
"I/Q Mod A", "I/Q Mod B"	For example, options R&S SMW-B1003/-B2003
"I/Q Analog A", "I/Q Analog B"	R&S SMW-B13 or R&S SMW-B13T
"I/Q Digital A", "I/Q Digital B"	One or two options R&S SMW-K18
"RF A", "RF B"	For example, options R&S SMW-B1003/-B2003

For more information, refer to the specifications document.

#### 3.4.1.2 Internal baseband source (Baseband blocks)

The "Baseband" block represents the source of the baseband signals (basebands).

This functional block is the access point to:

- *The internal baseband generator*



The baseband generator contains modules for real-time signal generation (custom digital modulation) and an arbitrary waveform generator (ARB).

One or two baseband generators can be fitted in an R&S SMW200A and operated separately.

- *The available digital standards*  
Generation of digital signals in accordance with the supported standards requires additional software options. For example, option R&S SMW-K55 generates signals according to the EUTRA/LTE standard.
- *The signal routing (in the standard "classic" mode of a standard baseband generator)*  
Signals from the baseband generators can be routed between the available paths, and added (possibly with frequency, phase and power offsets).

#### 3.4.1.3 Digital I/Q input and output (BB Input, I/Q Digital blocks)

Equipped with the required SW and HW options, the R&S SMW200A is able to receive and to output digital baseband signals. A fully equipped standard baseband instrument provides eight configurable digital interfaces. Depending on the configuration, you can use the available digital interfaces for up to six inputs or up to six outputs.

The "BB Input" block opens settings to configure the following:

- *The external digital I/Q signals*  
The external digital I/Q signals are further processed in the baseband section (e.g. fading, addition of noise)
- *The signal routing (in the standard "classic" mode)*  
The external and internal baseband signals can be routed and added (possibly with frequency, phase and power offsets).

The "I/Q Digital" block opens settings to configure the following:

- The digital I/Q output signals
- The digital I/Q impairments

Use the digital baseband inputs and outputs together with other Rohde & Schwarz instruments, like signal generators, signal analyzers or mobile communication tester. A Rohde & Schwarz signal generator, for example, can serve as a digital signal source in a test configuration requiring more than two baseband sources. A test setup with the R&S CMW is suitable for testing under fading conditions.

#### 3.4.1.4 Fading simulator (Fading blocks)

The "Fading" block is displayed only in instruments equipped with the option R&S SMW-B14/-B15, fading simulator. This block controls the fading module and, in standard mode, the signal routing at the output of this module.

The fading simulator functionality enables you to simulate real-time fading effects on the baseband signal. Equipped with the required options, you can simultaneously create up to 20 dynamic fading paths in a SISO mode (single input single output). For MIMO mode, you can create up to 20 paths per MIMO channel. Fading extension options provide even more functionality.

#### 3.4.1.5 Additional white Gaussian noise (AWGN blocks)

Displaying the "AWGN" block requires at least one option R&S SMW-K62. This block controls the additional white Gaussian noise generator (AWGN). An additive white noise is required for measurements of base stations.

#### 3.4.1.6 I/Q stream mapper (I/Q Stream Mapper block)

The "I/Q Stream Mapper" block opens settings to configure the distribution and mapping of the generated I/Q streams. You can route these streams to the RF connectors, the analog I/Q output connectors or to the digital I/Q output connectors.

#### 3.4.1.7 I/Q modulator (I/Q Mod blocks)

The "I/Q Mod" blocks represent the I/Q modulators.

These functional blocks are the access points to:

- The I/Q modulation of the internal baseband signal
- The I/Q modulation of an external analog wideband signal (single ended or differential)
- The analog I/Q impairments

#### 3.4.1.8 Analog I/Q output (I/Q Analog blocks)

The "I/Q Analog" blocks represent the analog I/Q output connectors.

This block is the access point to the settings of:

- The analog I/Q output signals  
The generated signal can be output as a single-ended or differential analog signal.
- The analog I/Q impairments

#### 3.4.1.9 RF and analog modulations (RF blocks)

The "RF" blocks represent the RF settings of the instrument.

This block is the access point to:

- RF frequency and level settings, the reference frequency, local oscillator, user correction, etc.
- The analog modulations
- The list and sweep modes

### 3.4.2 Applications examples of the R&S SMW200A

Due to its modularization, the R&S SMW200A can be optimally adapted to the requirements of different applications:

- Generation of digitally modulated signal

The main field of application of the R&S SMW200A is the generation of digitally modulated signals. The R&S SMW200A generates a digitally modulated signal in several ways: using the internal baseband generator, using the externally applied digital baseband signals or in an analog wideband I/Q operation.

- Generation of test signals for diversity tests and MIMO scenarios  
The R&S SMW200A enables you to generate test signals in a versatile MIMO configuration for which several signal generators were previously required.
- Generation of a wanted signal and an interference signal for receiver tests
- Addition of real-time signals of different standards, for example EUTRA/LTE and 3GPP FDD
- Generation of signals with up to 4.32 GHz signal bandwidth, for example for WLAN IEEE 802.11ay signals
- Generation of fading scenarios, for example for test setups involving R&S SMW200A and R&S CMW

A few examples are given in the following.

### 3.4.2.1 Transmit diversity test (MISO scenario)

The block diagram in this example depicts the generation of a test signal using both internal baseband generators and 1 RF output (RF A).

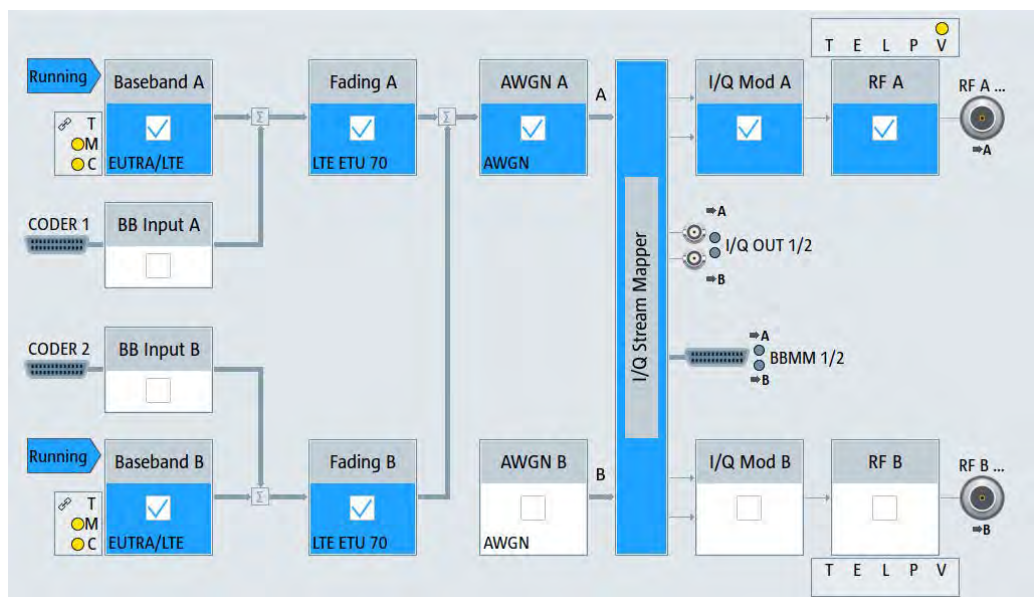

### 3.4.2.2 Receive diversity test (SIMO scenario)

The block diagram in this example depicts the generation of a test signal using one internal baseband generator ("Baseband A") and distributing the signal to both RF outputs.

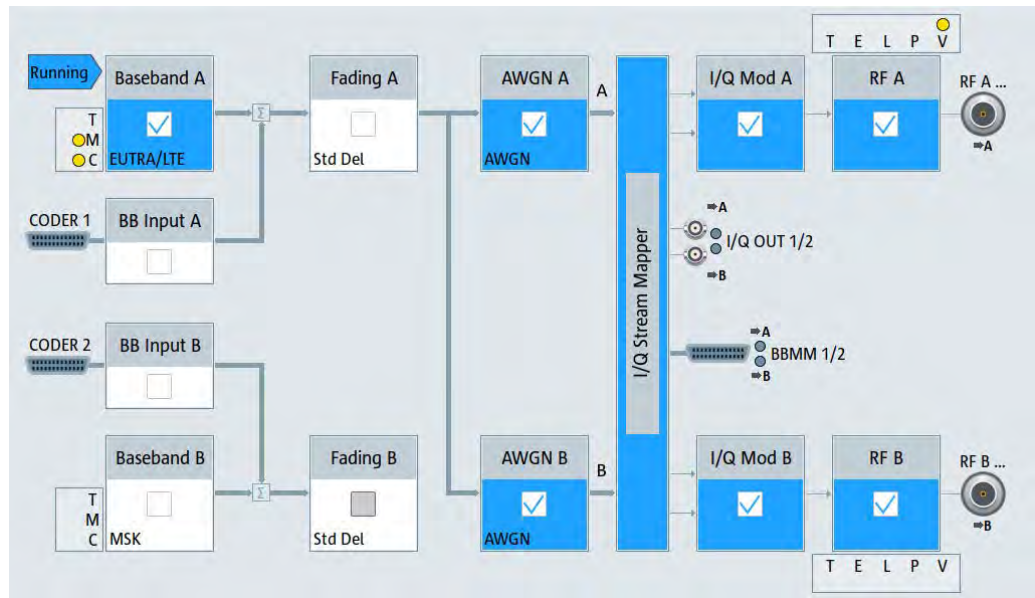

### 3.4.2.3 WCDMA test signal for handover (two cells)

The block diagram in this example depicts the generation of a test signal using both internal baseband generators and both RF outputs, for example for handover tests. The R&S SMW200A acts as two independent generators in one instrument.

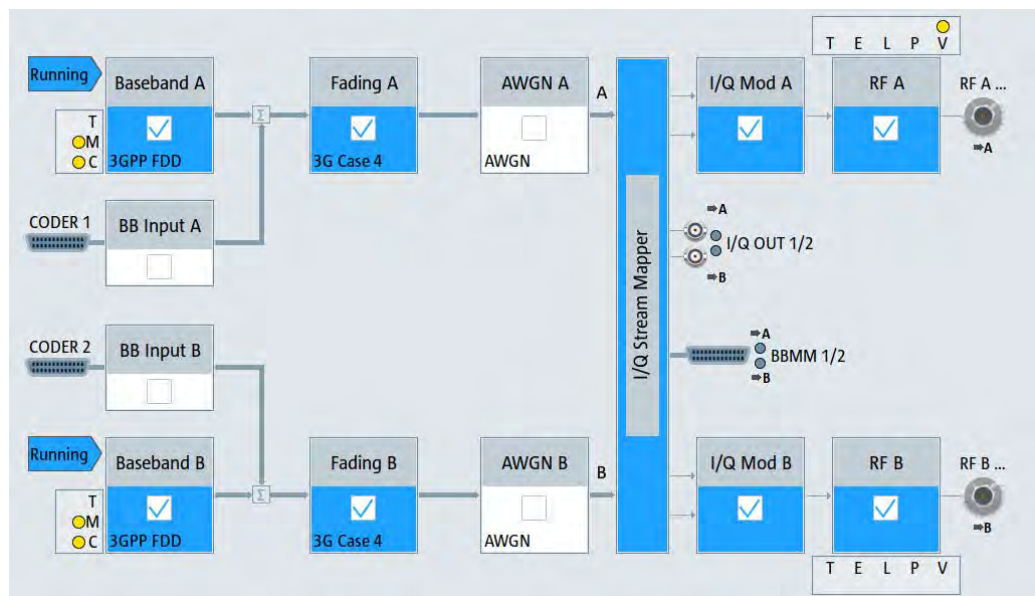

### 3.4.2.4 EUTRA/LTE test signal with 8x2 MIMO

The block diagram in this example depicts the generation of an EUTRA/LTE test signal in a 8x2 MIMO scenario, for example for UE tests. The instrument uses a coupled internal baseband source to generate all required baseband signals.

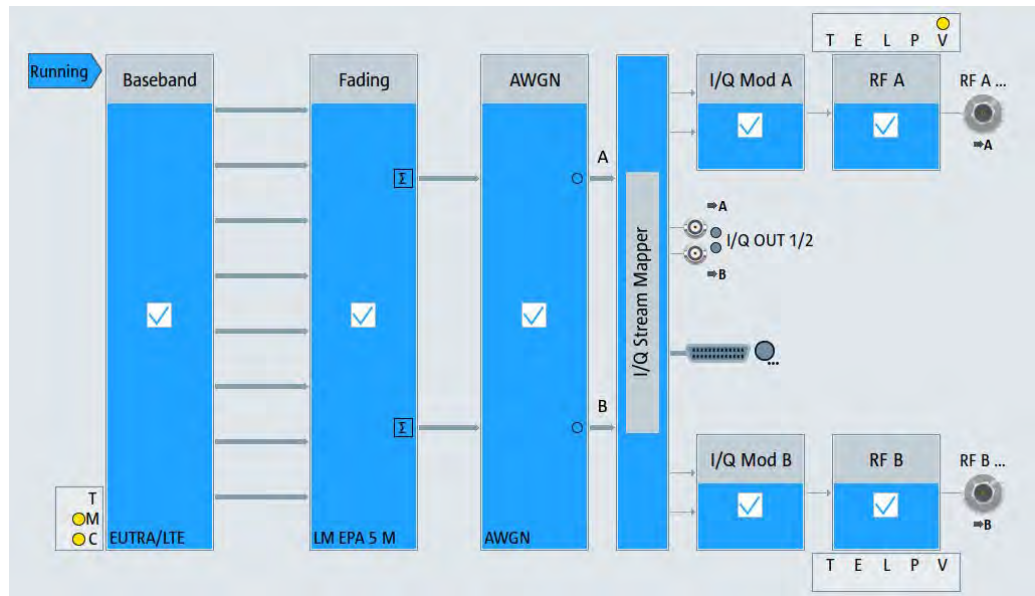

### 3.4.2.5 EUTRA/LTE test signal with CA and 2x2 MIMO

The block diagram in this example depicts the generation of an EUTRA/LTE test signal with carrier aggregation (CA), for example for UE tests. This signal provides two component carriers (intra-band carrier aggregation) and 2x2 MIMO fading for each carrier. The instrument uses a coupled internal baseband source and both RF outputs.

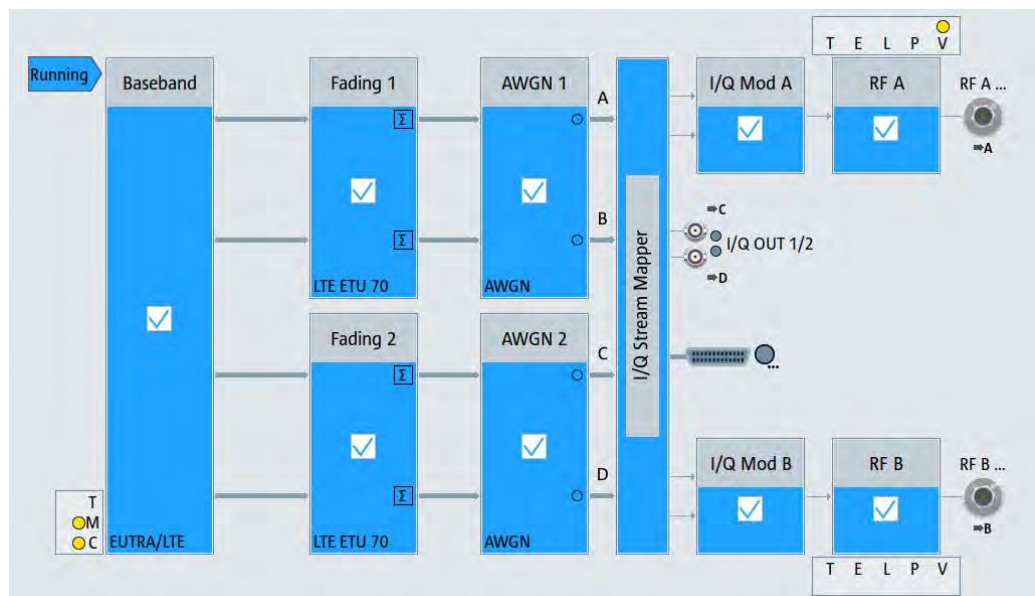

### 3.4.2.6 IEEE 802.11ad/ay wideband test signal

The block diagram in this example depicts the generation of an IEEE 802.11ad/ay test signal with up to 2.16 GHz bandwidth. The instrument uses one internal wideband baseband generator and one RF output.

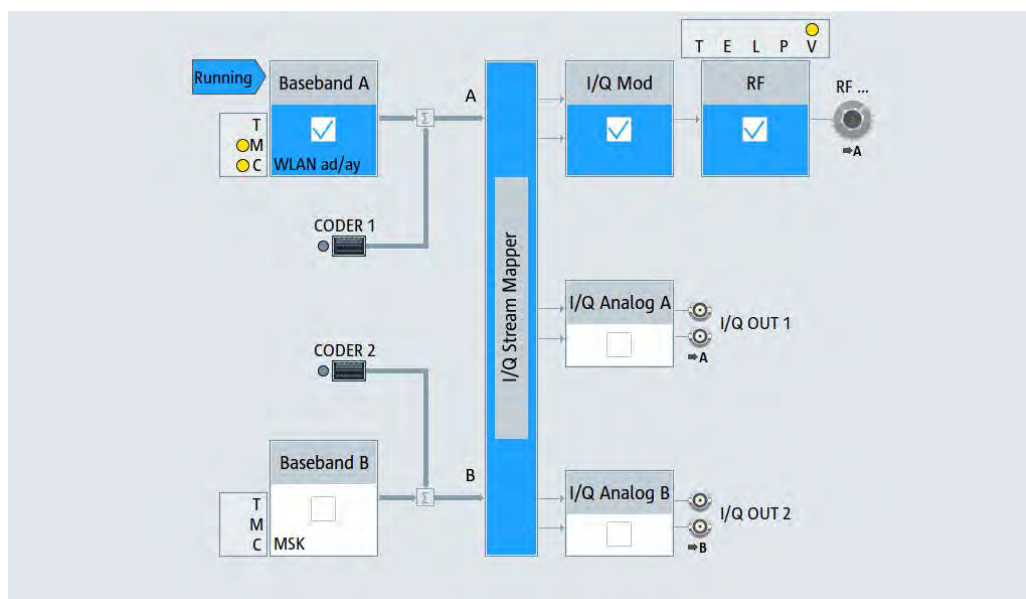

Also, you can generate wider bandwidth signals, for example EDMG carrier signals with a bandwidth of 4.32 GHz. These signals require both wideband baseband generators (2 x R&S SMW-B9) and the bandwidth extension option (R&S SMW-K555).

### 3.5 Operating the instrument

This chapter provides an overview on basic operating tasks. There are three ways to operate the R&S SMW200A.

#### Manual operation

Use the touchscreen, keys and rotary knobs, or an optional mouse and/or keyboard. The principles of manual operation are explained in this section.

#### Remote control

Create programs to automatize repeating settings, tests, and measurements. The instrument is connected to a computer that runs the program.

This way of operation is described in [Section 13.1, "Overview of remote access modes"](#), on page 817.

#### Remote operation

For remote monitoring and operation of the instrument, a VNC server is installed on the R&S SMW200A. You need a LAN connection to the computer, and a VNC client or browser to connect to the instrument.

This way of operation is described in [Section 13.1, "Overview of remote access modes"](#), on page 817.

The following sections show how to operate the instrument manually.

• <a href="#">Means of manual interaction</a> .....	87
• <a href="#">Understanding the display information</a> .....	88
• <a href="#">Accessing the functionality</a> .....	93
• <a href="#">Entering data</a> .....	94
• <a href="#">Undo and redo actions</a> .....	95
• <a href="#">Getting information and help</a> .....	95

### 3.5.1 Means of manual interaction

For the manual interaction with the R&S SMW200A, you have several methods that you can use as an alternative to perform a task:

- **Touchscreen:**  
Touchscreen operation is the most direct way to interact. Almost all control elements and actions on the screen are based on the standard operating system concept. You can tap any user interface element to set parameters in dialog boxes, enter data, scroll within a dialog etc., as if you work with a mouse pointer.  
Tapping the screen works like clicking mouse buttons:
  - Touch quickly = click: Selects a parameter or provokes an action.
  - Touch and hold = right-click: Opens a context-sensitive menu.
  - Touch and drag = drag&drop:  
Moves a window (dialog or graphic) by dragging it to a new position on the screen, or  
Routes a signal by selecting a block and dragging to the destination block, or  
Resizes a window (dialog or graphic) by dragging an edge or a corner of a window to the destination size
  - Touch and swipe = drag: Scrolls through the contents of a display element larger than the screen, e.g. a list or a table.
  - Spread or pinch two fingers = zoom out, zoom in:  
Increases or decreases the size of an area in a graphical display as it works on your cell phone
- **Function keys and rotary knob:**  
The front panel provides nearly all functions and controls to operate the instrument in the classic way, without touchscreen.
- **Optional mouse and/or keyboard:**  
These devices work like known from PCs. The navigation keys on the front panel correspond to the keys on the keyboard.

This manual describes the manual interaction with the instrument via the touchscreen. It mentions the alternative methods using the keys on the instrument or the on-screen keypads if it deviates from the standard operating procedures. The usage of the touchscreen and navigation keys is described in [Section 3.5.3, "Accessing the functionality"](#), on page 93.

Throughout the manual, the term "select" refers to any of the following methods:

- Using a finger on the touchscreen
- Using a mouse pointer in the display

- Using a key on the instrument or on a keyboard

### 3.5.2 Understanding the display information

The block diagram of the R&S SMW200A displays all main settings and generator states, divided into main operation areas.

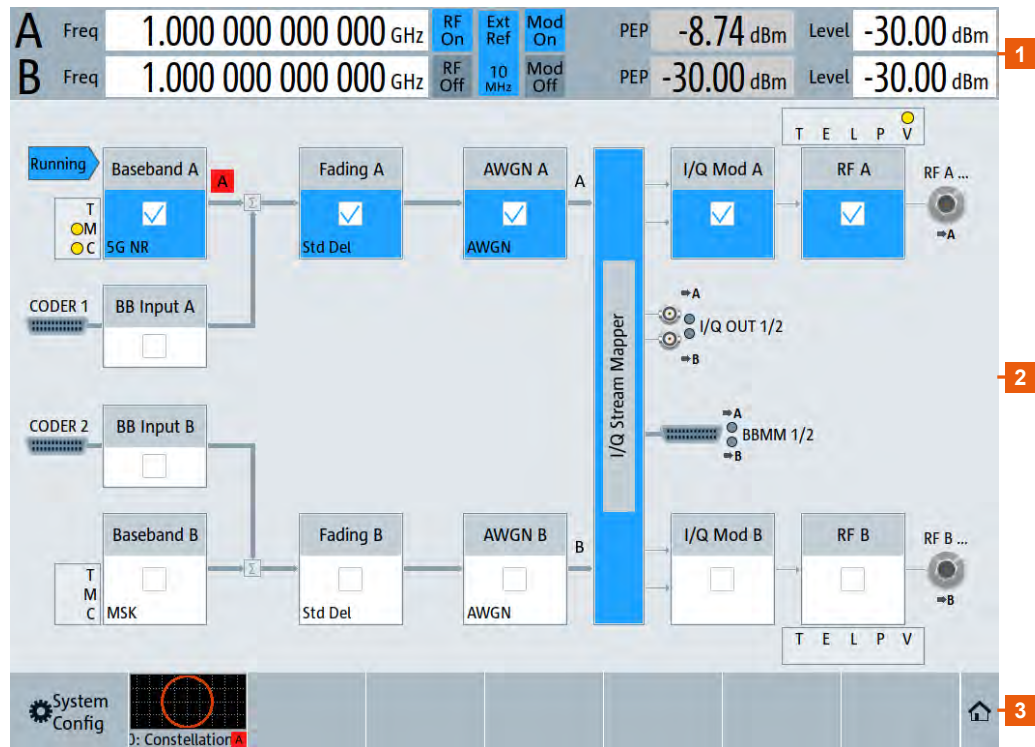

Figure 3-18: Block diagram

- 1 = Status bar
- 2 = Block diagram
- 3 = Taskbar/softkey bar

- [Status bar](#).....88
- [Block diagram](#)..... 89
- [Taskbar](#).....90
- [Additional display characteristics](#)..... 91

#### 3.5.2.1 Status bar

The status bar at the top of the screen indicates the RF frequency and the level of the output signal provided to the DUT. You can set both parameters directly here.

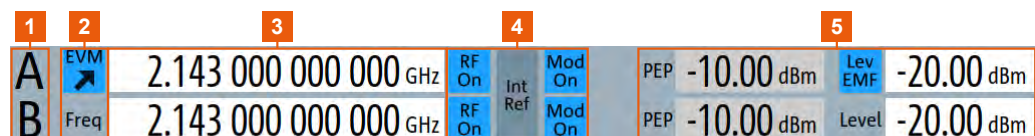



- 1 = Signal path
- 2 = Status buttons and RF frequency display
- 3 = RF frequency values
- 4 = Status buttons
- 5 = RF level display and status buttons

The status buttons indicate key parameters that are set for the output signal. Most of the status buttons are virtual keys that you can use to open a corresponding menu or dialog.

### 3.5.2.2 Block diagram

The block diagram shows the current configuration and the signal flow in the generator with the aid of function blocks, connected by signal lines.

The following figure displays almost all the elements that can appear in the block diagram. However, it does not necessarily represent a useful configuration.

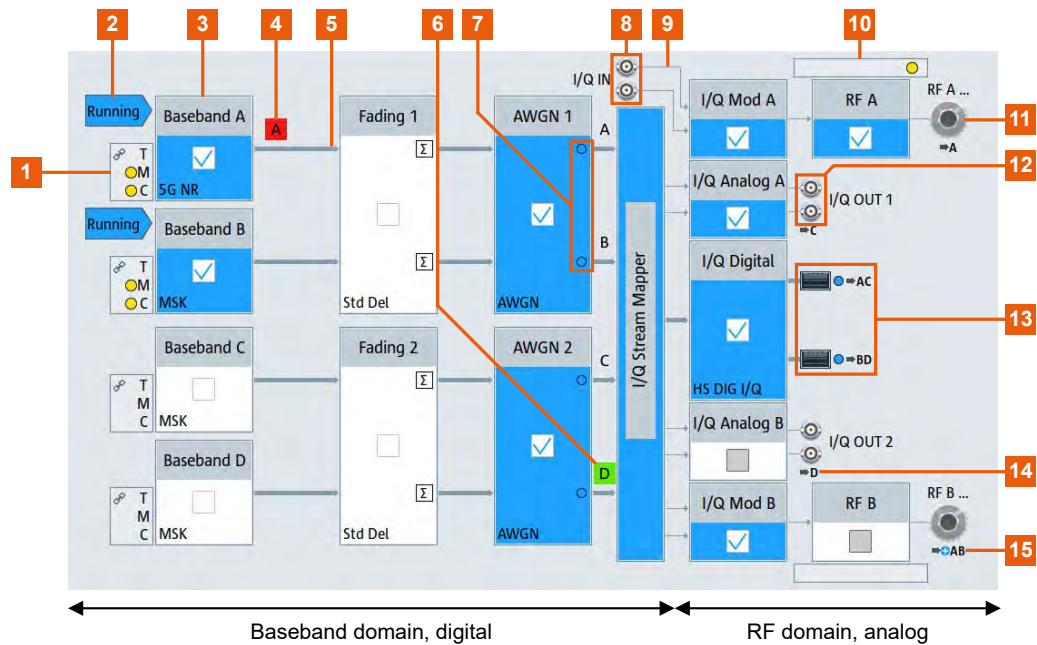

- 1, 10 = Control signal block
- 2 = Status indicator
- 3 = Functional block
- 4, 6 = Graphics indicator
- 5 = Signal line (digital)
- 7 = Stream status indicator (On/Off)
- 8, 11, 12, 13 = Connector icons (RF, analog, digital)
- 9 = Signal line (analog)
- 14, 15 = Stream indicator (Single, Add)

Starting from the left up to the "I/Q Stream Mapper", you can see the functional blocks provided in the baseband domain. After the stream mapper, the analog section contains the digital to analog conversion and modulation to RF.

Legend	Item	Description
1 10	Control signal block	Indicates information on the control signals like signal content, input or output and provides quick access to the corresponding configuration dialog. A dedicated control block is displayed to the left of a baseband block (1) and above/below the RF block (10).
2	Status indicator	Indicates if the signal is running or waiting for a trigger.
3	Functional block	Represents a basic task in signal generation. The push button provides access to any number of associated actions to accomplish the task. "On/Off" (checkbox) and the block label quickly enables the basic task.
4 6	Graphics indicator	Denotes that the signal is displayed graphically: Baseband signal (4), stream signal (6)
5 9	Signal line <ul style="list-style-type: none"> <li>digital</li> <li>analog</li> </ul>	Shows the currently configured signal flow: <ul style="list-style-type: none"> <li>Thick lines represent the digital I/Q streams (5).</li> <li>Thin lines represent the analog signals (9).</li> </ul>
7	Stream status indicators	Show the status of a stream (On/Off)
8 11 12 13	Connector icons	Represent the interfaces for signal input and output: <ul style="list-style-type: none"> <li>Analog I/Q signal connector input (8)</li> <li>RF signal connector output (11)</li> <li>Icons vary depending on the frequency.</li> <li>Analog I/Q signal connector output (12)</li> <li>Digital I/Q signal connector output (13)</li> </ul>
14 15	Stream indicators <ul style="list-style-type: none"> <li>Single</li> <li>Add</li> </ul>	Indicates the output streams that are routed to the corresponding connectors, and the way the streams are internally processed: <ul style="list-style-type: none"> <li>Single: One stream is mapped on the connector (15).</li> <li>Add: Multiple streams are routed to a connector (16).</li> </ul>

### 3.5.2.3 Taskbar

The "Taskbar" contains labeled softkeys and minimized views (thumbnails) of active graphics and dialogs.

Initially, it shows the permanently assigned softkeys. The softkey with the sine wave denotes that no signal is enabled for graphical representation.



Figure 3-19: Taskbar in default state

Whenever you open a settings or graphics dialog, it is automatically assigned to the "Taskbar". The softkeys shown in the following figure represent the variants.

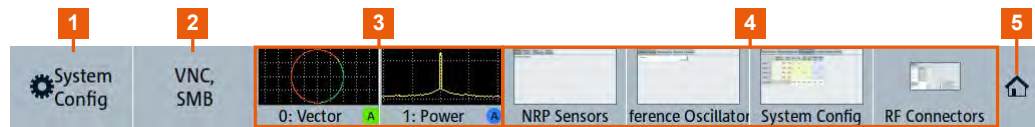

Figure 3-20: Taskbar with thumbnails

- 1 = System configuration
- 2 = Remote control connections
- 3 = Graphics
- 4 = Dialogs
- 5 = Homescreen or more thumbnails

1	System Config	Provides access to general system configurations like setup, display, or remote. The warning symbol signifies a permanent error message. It replaces the default symbol, as shown in <a href="#">Figure 3-19</a> .
2	Remote	Shows the established remote connections when the instrument is remotely controlled. <b>Tip:</b> An indicator in the status bar shows the current remote control status.
3	R&S NRP	Shows a connected external power sensor. If the sensor is active, the softkey background is blue.
4	Graphics	Shows that a signal is represented graphically.
5	Dialogs	Shows a dialog as a thumbnail, the dialog name, and the name of the signal channel.
6	Diagram / more	The diagram icon as shown in <a href="#">Figure 3-19</a> minimizes all dialogs indicated on the screen. The block diagram is in the foreground. The "More" softkey indicates that more dialogs are open than can be displayed in the taskbar. Use this softkey to open a selection list with the remaining active dialogs, and the "Diagram" function.

### 3.5.2.4 Additional display characteristics

The following section provides a short insight on the indication of the screen in general, and significant elements that you see under specific modes, in dialogs or settings.

- **Appearance of active elements**
  - *Active* elements like On/Off switches, state buttons have a **blue** background.
  - *Selected* elements are framed or highlighted **orange**.
  - *Inactive* elements are **gray**.
- **On-screen keypads**

Either a numerical or alphanumerical on-screen keypad appears when you enable an entry field, see [Section 3.5.4, "Entering data"](#), on page 94.
- **Info line**

The "Info line" shows brief status information and error messages. It appears when an event generates a message. If selected, the R&S SMW200A shows information on static errors and the error history.

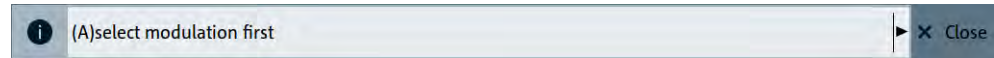

- **Key parameters indicated in tab labels**

Most dialogs are divided into tabs with logically grouped parameters. The tab label expresses the content and can also contain status indicators or the set value of a key parameter.



1, 2 = Status indicators  
3, 4 = Key parameter values

- **Scrollbar handle**

An arrow icon that appears when you touch a scrollbar helps you to scroll in a dialog or list.

- **Progress indicators**

A busy icon indicates a currently running process. If a process takes some time, a progress bar shows the current state.

- **Context-sensitive menus**

Within the entire screen display, including single parameters, you can access context-sensitive menus that provide some additional functions.

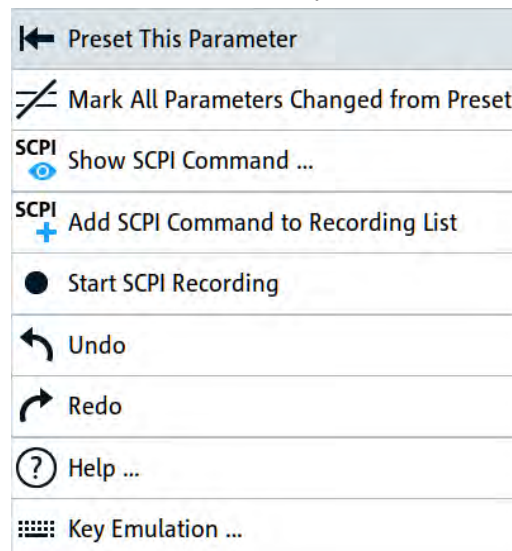

### 3.5.3 Accessing the functionality

All functionalities are provided in dialog boxes as known from computer programs. You can control the instrument intuitively with the touchscreen. This section provides an overview of the accessing methods.

The instrument's functions and settings can be accessed by selecting one of the following elements:

- System and function keys on the front panel of the instrument
- Taskbar/softkeys on the touchscreen
- Context-sensitive menus for specific elements on the touchscreen
- Elements on the status bar in the touchscreen
- Displayed setting on the touchscreen that means block diagram and all settings available in dialogs.

#### To open a dialog box

- ▶ Perform one of the following actions:
  - Select the required block, and then the menu entry.
  - Select the minimized view (thumbnail) on the taskbar.

Some of the utility keys access a dedicated dialog, too.

#### To minimize a dialog box

- ▶ Select the "Minimize" icon in the upper right corner.

#### To close a dialog box

To close a dialog box, you have the same controls as you know from computers or devices with touchscreen.

- ▶ Perform one of the following actions:
  - Select the "Close" icon in the upper right corner.
  - Select the [ESC] key on the front panel.
  - Drag and drop a minimized dialog from the taskbar to the block diagram.

#### To select an option in a dialog box

- ▶ Select the required option.

#### To select an option in a list

If you can select many options, these options are provided in a list. The current selection is shown on the list button.

1. Select in the list.
2. To navigate through the list, try out the following:
  - Using a mouse, scroll in the list to select the required option.
  - Use the rotary knob.
  - Use [ON/OFF TOGGLE] key to select the succeeding option

- Use the front panel keys:
  - a) Select the [Left/Right] arrow keys to navigate to the list button.
  - b) Select the [Enter] key to open the list.
  - c) Select the [Up/Down] keys to navigate to the required option in the list.
  - d) Select the [Enter] key to select the marked option.

### 3.5.4 Entering data

Some parameters have their own key on the front panel. For data input in dialog boxes, the instrument provides on-screen keypads for entering numeric and alphanumeric values. You can always set the parameters via the touchscreen, the front panel or an external keyboard.

#### To enter numeric values with the on-screen keypad

For numeric settings, the instrument displays the numeric keypad. The units specified correspond to the units of the parameter.

1. Enter the numeric value.

**Tip:** For a quick entry, you can enter a value in an exponential representation, for example  $1e7$  for  $10000000$ .

2. Tap the unit button to complete the entry.

The unit is added to the entry.

**Tip:** For a quick unit change, you can enter shortcuts, for example for a frequency value  $1e8h$  for  $100\text{ MHz}$ .

For an overview of shortcuts supported by the R&S SMW200A, see [Section B, "Unit shortcuts"](#), on page 1381.

3. If the parameter does not require a unit, confirm the entered value by pressing "Enter".

#### To enter numeric values with the front panel controls

1. Change the currently used parameter value by using the rotary knob or the [Up/Down] keys.
2. If the parameter does not require a unit, confirm the entered value by pressing the [Enter] key or any of the unit keys.

The instrument highlights the editing line to confirm the entry.

If you edit numeric data in tables, enable edit mode first. Press [Enter] or press the rotary knob.

#### To enter alphanumeric values

If a field requires alphanumeric input, you can use the on-screen keyboard to enter letters and characters including special characters.

**To complete an entry**

- ▶ Press the [Enter] key or the rotary knob.

**To correct an entry**

1. Using the arrow keys, move the cursor to the right of the entry you want to delete.
2. Press the [Backspace] key.
3. Deletes the entry to the left of the cursor.
4. Enter your correction.

**To abort an entry**

- ▶ Press the [ESC] key.  
The dialog box closes without changing the settings.

### 3.5.5 Undo and redo actions

Accessed via the context-sensitive menus, "Undo" allows you to restore one or more actions on the instrument. Depending on the available memory, the "Undo" steps can restore all actions.



"Redo" restores a previously undone action.

### 3.5.6 Getting information and help

In some dialog boxes, graphics are included to explain the way a setting works.

For further information, you can use the following sources:

- Tooltips give the value range of the parameter.
- The context help provides a functional description on a setting.
- The general help explains a dialog box, provides instructions, and general information.
- The tutorials are interactive examples and demonstrations on how to perform specific tasks.

**To access the tutorials**

- ▶ Follow the instructions in [Section 3.5.6.1, "Using the tutorials"](#), on page 97.

**To display context help**

- ▶ To access a help topic, perform one of the following:

- Tap and hold the parameter for which you need information.
- In the opening context menu, tap "Help".
- Tap the parameter.
- Press the [HELP] key.

The "Help" dialog opens. You can browse the help for further information.

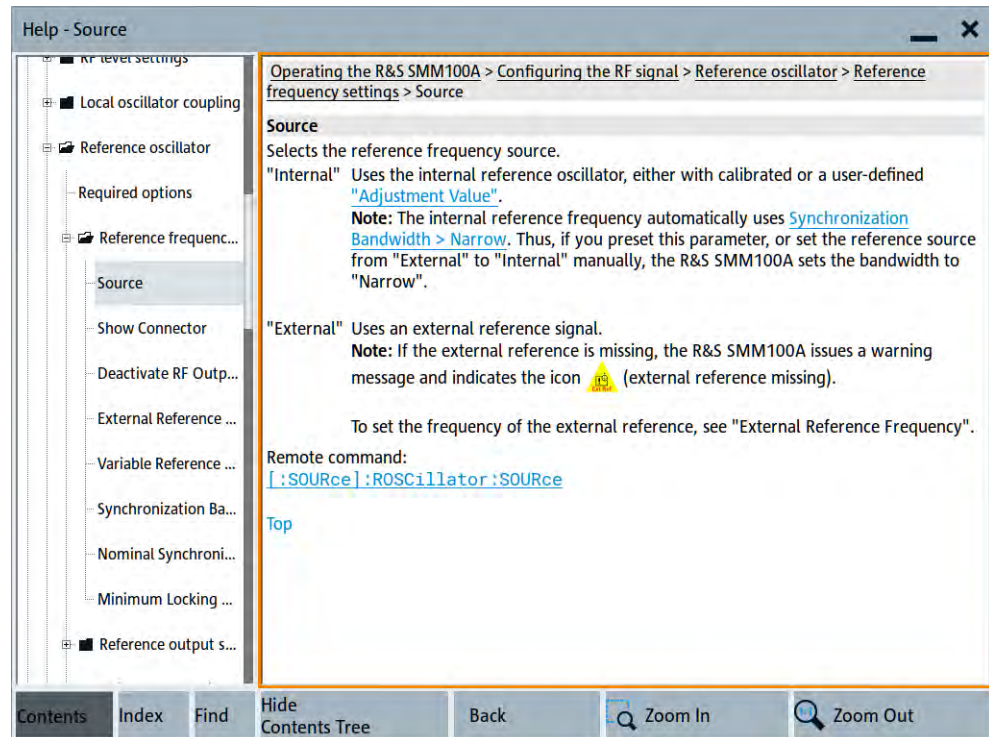

### Contents of the help dialog box

The help dialog box covers two main areas:

- "Contents" - contains a table of help contents
- "Topic" - contains a specific help topic

The help system also provides an "Index" and a "Find" area, and "Zoom" functions that are accessed via the corresponding buttons.

### To open general help

- ▶ Press the yellow [HELP] key on the front panel.

If a dialog box is opened, the help topic for the current tab is shown. Otherwise the "Contents" page appears.

### Navigating in the table of contents and in the help topics

1. To move through the displayed content entries, tap on an entry. Entries with a plus sign contain further entries.
2. To display a help topic, tap on the topic name.



3. To follow a cross-reference, tap on the link text.
4. To return to the previous page, select "Back".  
This function scrolls back all steps that you have performed before.
5. Use the "scroll bars" to shift the visible section of content shown.
6. To maximize the "Topics" area, tap the "Hide Contents Tree" button to hide the contents tree.

### Using the index

1. Select the "Index" button.
2. Enter the first characters of the topic that you are interested in.  
The entries starting with these characters are displayed.
3. Tap on the index entry.  
The corresponding help topic is displayed.

#### 3.5.6.1 Using the tutorials

A set of tutorials is embedded in the software. The tutorials are interactive examples and demonstrations on how to perform specific tasks.

#### To start a tutorial in an interactive step-by-step mode

1. Press the [SETUP] key on the front panel.
2. Scroll-down in the list, tap on the "Help" section to expand it.
3. Tap on "Tutorials".

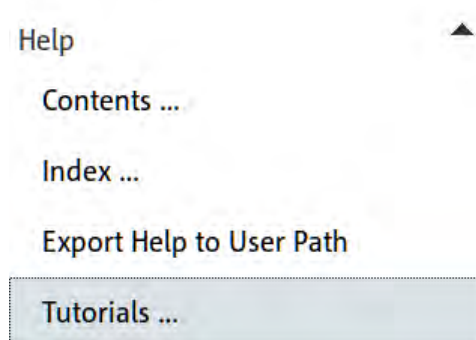

The "Tutorials" dialog opens.

4. Select "File" > "Load Predefined Tutorial".

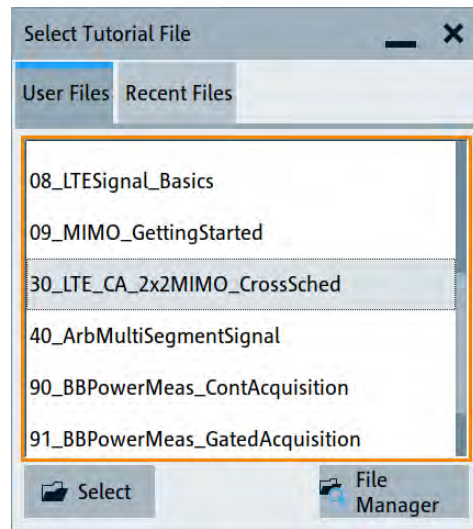

5. Tap on a tutorial from the list.
6. Confirm with "Select".

The preview section displays the content of the file if available.

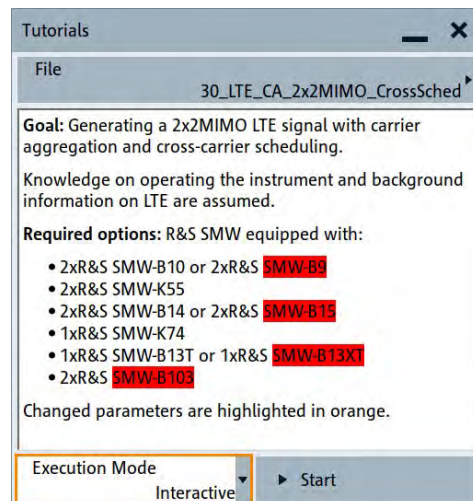

7. Use the default mode that is "Execution Mode" > "Interactive".
8. Tap on the "Start" button.
9. Observe the information displayed in the "Info" line (bottom of the display).

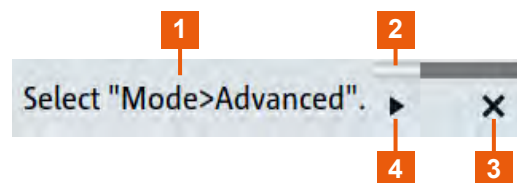

- 1 = Tutorial step description
- 2 = Progress bar
- 4 = "Stop": terminates the tutorial
- 3 = "Next Step": confirms the execution of the tutorial step

10. To execute a subsequent step, select the "Next Step" button.

A blinking cursor indicates the block or parameter affected by the step.



The instrument performs the configurations step by step and expects your confirmation. Dialogs are opened and closed; changed parameters are highlighted in orange.

Additional information is displayed in the "Info" line.

### To stop the tutorial

The demonstration can be terminated at any time.

- ▶ Select the "Stop" button.

The demonstration stops.



You can reopen the "Tutorials" dialog and start another file or exit the tutorial mode.

### To use the demonstration mode

1. Start the tutorial as described in ["To start a tutorial in an interactive step-by-step mode"](#) on page 97.
2. In the "Tutorials" dialog, select "Execution Mode" > "Auto (Looped) 3 sec".

The configurations are performed automatically; your interaction is not required. Dialogs are opened and closed; changed parameters are highlighted in orange. Additional information is displayed in the "Info" line.

See also:

- [Section E, "Available tutorial files"](#), on page 1389
- The application sheet "RS\_SMW\_CreatingTutorials\_AppSheet", available for download from the R&S website, on the R&S SMW200A [product page](#).

## 4 Signal routing and system configuration

The R&S SMW200A provides multiple routing possibilities and simplifies the definition of versatile MIMO configurations.

Provided the instrument is equipped with the required options, R&S SMW200A can:

- Process the internally generated digital baseband signal
- Process an external digital signal
- Generate vector-modulated baseband signals, irrespectively of the signal source
- Impair, add noise, and apply fading to digital baseband signals.

Generally, the processing of the generated baseband signal involves a modulation on the selected radio frequency (RF) and output at the RF connectors. However, the digital baseband signal can also be output directly, or converted and output as an analog I/Q signal.

To support you in your configuration tasks, the R&S SMW200A provides the "System Configuration" dialog. The main focus of this section is the "System Configuration" settings. This section also introduces the concept of the signal routing possibilities and covers the settings provided for the adjustment of the input and output analog and digital signals.

### Instrument equipment

The information in the following sections assumes a fully equipped R&S SMW200A. If your instrument is not equipped with dedicated options, for example, the instrument is equipped with only one signal path or without a fading simulator.

- [Working with the system configuration function](#)..... 100
- [Possible ways to configure the signal flow](#)..... 105
- [Overview of the signals and interfaces](#)..... 108
- [System configuration settings](#)..... 118
- [Signal routing settings](#)..... 147
- [Digital baseband input settings](#)..... 151
- [I/Q digital output settings](#)..... 164
- [I/Q analog output settings](#)..... 176
- [How to connect external instruments and configure the signal flow](#)..... 182

### 4.1 Working with the system configuration function

The R&S SMW200A vector signal generator is an instrument with outstanding characteristics that can serve a wide range of test cases. Irrespective of your current use case, the decision process on how to fulfill the task with the R&S SMW200A and what kind of configurations are necessary, undergoes the same main phases.

The "System Configuration" settings and capabilities support the decision and the configurations in these main phases. It helps you, for instance, to define MIMO configura-

tions, to route the signal through the instrument, and to connect and control external instruments.

### 4.1.1 Configuring the system for your test case

#### Prerequisites

The provided instrument settings help you to decide for your test case and support you to configure connected external instruments. Keep in mind the capability of your instrument to evaluate the type and number of additional instruments that are required in the current test setup.

#### General workflow

The general workflow comprises the main phases listed below. The "System Configuration" helps you in phase 3, 4 and 5.

1. Analyzing the use case/test case and deciding whether the test setup requires external instruments, either as a baseband source or as an RF frontend.  
In general, a test setup that requires more than two receiver antennas requires additional instruments.  
**Tip:** Compare your current test case with the example scenarios listed in [Table 4-1](#). The table provides information on the required fading and baseband configuration, the used baseband source, the required output interfaces, and a summary of required instruments.
2. Connecting and cabling the instruments.  
Typically, all instruments use the same reference frequency signal. Connect these instruments via LAN or USB interfaces to the R&S SMW200A.
3. Configuring the signal flow by selecting the suitable fading and baseband configurations and deciding whether coupled or separate baseband sources are necessary.  
The most powerful way is to rely on the [Fading and baseband configuration settings](#).  
See also [Section 4.2, "Possible ways to configure the signal flow"](#), on page 105.
4. Distributing and mapping the I/Q streams to the required output interfaces.  
See [Section 4.4.2, "I/Q stream mapper settings"](#), on page 127.
5. Establishing connection to the external instruments.  
See [Section 4.4.3, "External RF and I/Q settings"](#), on page 129  
You can also manually configure the correct input and output interfaces the R&S SMW200A expects the signal from or outputs the signal at.  
See [Section 4.3, "Overview of the signals and interfaces"](#), on page 108.
6. Configuring the baseband signal, enabling fading, and defining the signal-to-noise ratio (SNR), if necessary.  
Adjusting the RF frequency and further required settings.

7. Starting the signal generation.

For step-by-step descriptions, see [Section 4.9, "How to connect external instruments and configure the signal flow"](#), on page 182.

## 4.1.2 Test scenario and required system configuration

### Short representations of fading and baseband configurations

Throughout this description, the fading and baseband configurations are represented in a short form that follows the predefined structure

<#Entity>x<#Basebands>x<#Streams> (LxMxN). The last two blocks are identical with the standard convention used to describe a MxN MIMO system.

#### Example:

The abbreviation 1x8x2 is a representation of a one-entity 8x2 MIMO system; a 2x2x2 configuration is a scenario with two entities with a 2x2 MIMO system each.

The information in [Table 4-1](#) provides a cross-reference between a test scenario, the required system configuration at the instrument and the total number of required instruments including additional R&S SMW200A instruments, if needed. R&S SMW200A system configuration includes <#Entity>x<#Basebands>x<#Streams> (LxMxN), the baseband sources ("BB Source Config") and output signals of the R&S SMW200A.

The "Fading/Baseband Config" tab of the "System Configuration" dialog serves the opposite way. The tab provides a short description of the selected configuration including an example.

**Table 4-1: Test scenario overview and system configuration (R&S SMW-B10)**

Test scenario	Description	LxMxN	Baseband sources	Output signals	All instruments
LTE 4x4 MIMO	User equipment (UE) or base station (BS) tests How to: <a href="#">Section 4.9.3, "How to define the MIMO scenario"</a> , on page 185	1x4x4	Coupled sources	<ul style="list-style-type: none"> <li>• RF A, RF B</li> <li>• I/Q 1/2</li> </ul> or <ul style="list-style-type: none"> <li>• RF A, RF B</li> <li>• BBMM 1/2</li> </ul>	<ul style="list-style-type: none"> <li>• 1x R&amp;S SMW200A</li> <li>• 2x R&amp;S SGS</li> </ul> or <ul style="list-style-type: none"> <li>• 1x R&amp;S SMW200A</li> <li>• 2x R&amp;S SGT</li> </ul>
LTE 2x8 MIMO beamforming	TD-LTE BS test, e.g. beamforming tests How to: <a href="#">Section 4.9.8, "How to generate a 2x8 MIMO signal for BS tests"</a> , on page 203	1x2x8	Coupled sources	<ul style="list-style-type: none"> <li>• 2x RF A, 2x RF B</li> <li>• 2x I/Q 1/2</li> </ul> or <ul style="list-style-type: none"> <li>• RF A, RF B</li> <li>• BBMM 1/2</li> <li>• FADER 1/2/3/4</li> </ul>	<ul style="list-style-type: none"> <li>• 2x R&amp;S SMW200A</li> <li>• 4x R&amp;S SGS</li> </ul> or <ul style="list-style-type: none"> <li>• 1x R&amp;S SMW200A</li> <li>• 2x R&amp;S SGT</li> <li>• 4x R&amp;S SGT</li> </ul>
LTE 8x2 MIMO UE tests	TD-LTE UE tests	1x8x2	Coupled sources	RF A, RF B	1x R&S SMW200A

Test scenario	Description	LxMxN	Baseband sources	Output signals	All instruments
LTE 8x8 MIMO	LTE TM9 and TM10 tests with two component carriers and 8x8 MIMO each How to: <a href="#">Section 4.9.9, "How to generate a 8x8 MIMO signal with two R&amp;S SMW200A"</a> , on page 204	1x8x8	Coupled sources	<ul style="list-style-type: none"> <li>2x RF A, 2x RF B</li> <li>2x I/Q 1/2</li> </ul> or <ul style="list-style-type: none"> <li>2x RF A, 2x RF B</li> <li>2x BBMM 1/2</li> </ul>	<ul style="list-style-type: none"> <li>2x R&amp;S SMW200A</li> <li>4x R&amp;S SGS</li> </ul> or <ul style="list-style-type: none"> <li>2x R&amp;S SMW200A</li> <li>4x R&amp;S SGT</li> </ul>
LTE-A carrier aggregation with 2x2 MIMO	UE test with two component carriers (carrier aggregation) and 2x2 MIMO each	2x2x2	Coupled sources	Intra-band <ul style="list-style-type: none"> <li>RF A, RF B</li> </ul> Inter-band 1 <ul style="list-style-type: none"> <li>RF A, RF B</li> <li>I/Q 1/2</li> </ul> Inter-band 2 <ul style="list-style-type: none"> <li>RF A, RF B</li> <li>BBMM 1/2</li> </ul>	Intra-band <ul style="list-style-type: none"> <li>1x R&amp;S SMW200A</li> </ul> Inter-band 1 <ul style="list-style-type: none"> <li>1x R&amp;S SMW200A</li> <li>2x R&amp;S SGS</li> </ul> Inter-band 2 <ul style="list-style-type: none"> <li>1x R&amp;S SMW200A</li> <li>2x R&amp;S SGT</li> </ul>
LTE-A intra-band carrier aggregation with 2x2 MIMO	Test with four component carriers (carrier aggregation) and 2x2 MIMO each	4x2x2	Coupled sources	RF A, RF B	Intra-band <ul style="list-style-type: none"> <li>1x R&amp;S SMW200A</li> </ul> Inter-band <ul style="list-style-type: none"> <li>2x R&amp;S SGT</li> </ul>
LTE-A Rel. 11 felCIC	Further enhanced inter-cell interference coordination (felCIC) tests	3x2x2	Coupled sources per entity	RF A, RF B	1x R&S SMW200A
LTE intra-band carrier aggregation with 4x4 MIMO	Test with two component carriers and 4x4 MIMO each	2x4x4	Coupled sources/ coupled sources per entity	RF A, RF B	1x R&S SMW200A 2x R&S SGT
LTE multi-user	PUCCH test with 4 UEs according to TS 36.141	1x4x2	Separate sources	RF A, RF B	1x R&S SMW200A
WCDMA type 3i	One wanted cell and two interfering cells, each with Rx diversity according to TS 34.121	1x3x2	Separate sources	RF A, RF B	1x R&S SMW200A
DC-DB-HSDPA with 2x2 MIMO	Two WCDMA cells with 2x2 MIMO each	2x2x2	Separate sources	<ul style="list-style-type: none"> <li>RF A, RF B</li> <li>I/Q 1/2</li> </ul> or <ul style="list-style-type: none"> <li>RF A, RF B</li> <li>BBMM 1/2</li> </ul>	<ul style="list-style-type: none"> <li>1x R&amp;S SMW200A</li> <li>2x R&amp;S SGS</li> </ul> or <ul style="list-style-type: none"> <li>1x R&amp;S SMW200A</li> <li>2x R&amp;S SGT</li> </ul>
WLAN 802.11ac with 160 MHz	WLAN 802.11ac with 160 MHz and 4 TX antennas (without dyn. fading)	4x1x1	Coupled sources	<ul style="list-style-type: none"> <li>RF A, RF B</li> <li>I/Q 1/2</li> </ul> or <ul style="list-style-type: none"> <li>RF A, RF B</li> <li>BBMM 1/2</li> </ul>	<ul style="list-style-type: none"> <li>1x R&amp;S SMW200A</li> <li>2x R&amp;S SGS</li> </ul> or <ul style="list-style-type: none"> <li>1x R&amp;S SMW200A</li> <li>2x R&amp;S SGT</li> </ul>
WLAN 802.11ac with 80 MHz	WLAN 802.11ac with 80 MHz and 3x3 MIMO	1x3x3	Coupled sources	<ul style="list-style-type: none"> <li>RF A, RF B</li> <li>I/Q 1/2</li> </ul> or <ul style="list-style-type: none"> <li>RF A, RF B</li> <li>BBMM 1/2</li> </ul>	<ul style="list-style-type: none"> <li>1x R&amp;S SMW200A</li> <li>2x R&amp;S SGS</li> </ul> or <ul style="list-style-type: none"> <li>1x R&amp;S SMW200A</li> <li>2x R&amp;S SGT</li> </ul>

Test scenario	Description	LxMxN	Baseband sources	Output signals	All instruments
WLAN 802.11ad/ay with 1.76 GHz	WLAN 802.11ad/ay at intermediate frequencies (8 GHz to 17 GHz) Requires R&S SMW-B9 and R&S SMW-B1020 or higher.	2x1x1	Separate sources	RF A	1x R&S SMW200A
WLAN 802.11ad/ay with 1.76 GHz	WLAN 802.11ad/ay at 58.3 GHz to 64.8 GHz Requires R&S SMW-B9 and R&S SMW-B1067.	2x1x1	Separate sources	RF A	1x R&S SMW200A
MSR (Multi-Standard Radio)	Multi-Standard Radio with 8 individual carriers (e.g. GSM, WCDMA, LTE, etc.) within one frequency band (without fading)	8x1x1	Coupled sources	RF A	1x R&S SMW200A
WCDMA UE tests	Tests with three WCDMA UEs	3x1x2	Separate sources	<ul style="list-style-type: none"> <li>• RF A, RF B</li> <li>• BBMM Out x</li> </ul> or <ul style="list-style-type: none"> <li>• RF A, RF B</li> <li>• BBMM 1/2</li> <li>• FADER 3/4</li> </ul>	<ul style="list-style-type: none"> <li>• 1x R&amp;S SMW200A</li> <li>• 4x R&amp;S SGT</li> </ul> or <ul style="list-style-type: none"> <li>• 1x R&amp;S SMW200A</li> <li>• 4x R&amp;S SGT</li> </ul>
WCDMA hand-over	Two WCDMA cells	2x1x1	Separate sources	RF A, RF B	1x R&S SMW200A
WCDMA/LTE mixed scenarios	BS/UE tests with LTE 2x2 MIMO and WCDMA 2x2 MIMO	2x2x2	Coupled sources per entity	<ul style="list-style-type: none"> <li>• RF A, RF B</li> <li>• BBMM 1/2</li> </ul>	<ul style="list-style-type: none"> <li>• 1x R&amp;S SMW200A</li> <li>• 2x R&amp;S SGT</li> </ul>
GSM AM suppression tests	Multichannel BS tests	3x1x1	Separate sources	RF A, RF B	1x R&S SMW200A

For a step-by-step description of how to perform the different steps, see [Section 4.9, "How to connect external instruments and configure the signal flow"](#), on page 182.

The table [Table 4-2](#) lists examples of test scenarios that utilize the fading functionality of the instrument.



Table 4-2: Scenarios for signaling tests

Test scenario	Description	LxMxN	Baseband sources	Input/output signals	All instruments
LTE-A carrier aggregation with 2x2 MIMO and signaling	UE test with two component carriers (carrier aggregation) and 2x2 MIMO each  How to: <a href="#">Section 4.9.10, "How to connect an R&amp;S®CMW500 for fading applications"</a> , on page 208	2x2x2	Coupled sources	Input: CODER 1/2 Output: BBMM 1/2	1x R&S CMW 1x R&S SMW200A
LTE 4x4 MIMO with signaling	UE or BS tests with signaling Input signal from R&S CMW required	1x4x4	Coupled sources	Input: CODER 1/2 Output: BBMM 1/2	1x R&S CMW 1x R&S SMW200A
MIMO over-the-air tests	UE MIMO over-the-air tests	2x2	Separated sources	Input: CODER 1/2 Output: BBMM 1/2	1x R&S CMW 1x R&S SMW200A

## 4.2 Possible ways to configure the signal flow

The R&S SMW200A provides different possibilities for configuring the signal flow. This section gives an overview of the available alternatives, starting with the simple manual configuration, to the automatically assisted routing for complex signal scenarios. Select the routing method most fitting to your needs and workflow.

For complex routing scenarios, like MIMO configuration and especially configuration involving several instruments, use the "System Configuration" functionality as the start and central configuration point.

We assume a fully equipped R&S SMW200A with [Standard baseband](#).

### 4.2.1 Using the signal routing settings and the block diagram

The following methods are provided in [Standard mode](#) and are suitable for the configuration of non-MIMO signal routing test scenarios.

#### Signal routing

This method is for a simple signal routing task involving routing and summing of the baseband signals up to the output of the "Fading" block. The signal routing possibilities are grouped in the "Signal Routing" sections of the corresponding block.

The signal routing influences:

- The signal flow of the baseband sources
- The routing of the output fading signal for the non-MIMO cases.

The provided settings are sufficient for standard test configurations with TX or RX diversity measurements with two antennas.

See section [Section 4.5, "Signal routing settings"](#), on page 147, for a detailed description of the provided settings.

### Drag&Drop blocks

Basically, this functionality achieves the same effect as the signal routing settings but extends it. It adds the possibility to route the generated streams to any of the digital and analog output connectors of the instrument. In other words, it covers the complete baseband domain including the functionality of the [I/Q stream mapper](#).

- To route the baseband signal, select the corresponding block ("Baseband A"/"Baseband B" or "BB Input A"). Drag it to the block of the signal, to that you want to route it through, e.g. "Fading A/B". Allowed routing possibilities are highlighted. The block diagram shows the resulting signal flow.
- To map a stream, select the "AWGN" block and drag it to the connector of the stream, at that you want to output the signal, e.g. "BBMM 2". If the associated block is hidden, it unfolds.  
Open the "I/Q Stream Mapper" to verify the routing.
- To break up the routing, perform the reverse operation, i.e. select the "Fading A"/"Fading B" block and drop it to the corresponding "Baseband A"/"Baseband B" or "BB Input A" block.

## 4.2.2 Using the system configuration capabilities

### Fading/Baseband configuration

Another way to configure the signal routing of the baseband signal and the fading block is to use the "System Configuration > Fading/Baseband Configuration" settings. The configuration settings are provided for two modes, for the standard non-MIMO configuration and for the advanced MIMO configuration respectively.

- The "Standard" fading and baseband configuration settings are a more detailed representation of the "Fading > Signal Routing" settings. The dialog provides some additional description, e.g. the common application of the current configuration.
- The "Advanced" fading and baseband configuration is required for the configuration of complex  $L_x M_x N$  MIMO scenarios.

For any allowed system configuration, the R&S SMW200A configures the signal flow **automatically upon just four parameters**:

- Number of entities (users or cells)
- Number of TX and RX antennas
- The decision whether coupled or separated baseband sources are used
- Type of generated signals, analog, digital, or multiplexed digital signals.

In this way, within one dialog you can configure complex configurations with:

- Up to 8 TX or RX antennas
- Up to four standalone 2x2 MIMO systems, e.g. 8x2 MIMO or LTE-A carrier aggregation with 2x2 MIMO
- Up to 8 SISO systems

See also [Table 4-1](#).

For any selected fading and baseband configuration, the dialog displays on-the-fly a simplified preview diagram of the signal routing. The selected configuration is applied after executing the "Apply" function; the configuration influences the signal flow up to the I/Q stream mapper.

See section [Section 4.4, "System configuration settings"](#), on page 118, for a detailed description of the provided settings.

### Coupled or separate baseband sources

To simplify the configuration of the baseband signal in some MIMO test scenarios, you can enable the R&S SMW200A to combine the available resources into a single baseband block. The R&S SMW200A then generates the required number of TX antennas out of it. The configuration of the various TX antennas is performed in a common dialog.

Depending on the selected baseband source, in particular when using coupled or coupled per entity basebands, not all digital standards are available. Coupled mode is supported by the "EUTRA/LTE" and "IEEE802.11 WLAN" digital standards, enabled in the "ARB" and with an external digital baseband signal.

- **Advantages of the coupled baseband sources**

Using coupled baseband sources is advantageous in complex test scenarios and enabled if a scenario requires the signal of more than one cell, TX antenna or entity.

In coupled mode, the instrument takes over the baseband signal configuration, adjusts the settings of all required basebands/entities automatically, and applies suitable trigger settings.

Coupling external digital baseband signals accelerates the configuration and provides a better overview by combining the settings within one central dialog.

- **Separate baseband sources**

Separate baseband sources are required for test scenarios involving the following:

- A mixture of internally generated and externally supplied baseband signals.
- A mixture of internally generated signals according to different digital standards.

### I/Q stream mapper

Irrespectively of the used signal routing method, it is possible to reconfigure the distribution and mapping of the I/Q streams to the output connectors.

Depending on the installed hardware options and the enabled "System Configuration > Fading/Baseband Configuration", up to *eight logical I/Q streams*, stream A to stream H, can be generated. The R&S SMW200A offers a flexible mapping functionality of these streams to the provided output connectors.

By default, the first two streams are mapped to the RF outputs. The stream mapping of all other streams depends on the current configuration, in particular the number of output streams, number of multiple entity systems, whether the fading simulator is bypassed or not. We recommend that you observe the stream mapping before performing further configurations.

See section [Section 4.4.2, "I/Q stream mapper settings"](#), on page 127, for a detailed description of the provided settings.

See also [Figure 4-1](#).

### External RF and I/Q instruments

The MIMO test scenarios with more than two RX antennas require the signal at both RF outputs and up to six additional RF signals. The instrument generates the required signal and routes it to the available output connectors as defined with one of the routing possibilities. Which logical information, i.e. which **stream**, is output at which connector is defined by the "IQ Stream Mapper" (see ["I/Q stream mapper"](#) on page 107).

The I/Q analog and digital output signal has to be processed by an additional instrument. The R&S SMW200A provides all settings required to configure the output connectors, to establish the connections to the connected RF instruments and to control them.

The R&S SMW200A acts as a **primary instrument** and controls setup-related parameters of **secondary instruments**. A secondary instrument constitutes any connected further processing external instrument. Examples are: R&S SGT, R&S SGS (also in combination with R&S SGU), R&S FSW.

Refer to:

- [Section 10.5, "Control and operation of external instruments"](#), on page 696
- [Section 4.4.3, "External RF and I/Q settings"](#), on page 129 for detailed description on the provided settings
- [Section 4.9.6, "How to connect and configure external instruments"](#), on page 189 for step-by-step description on how to connect and configure secondary instruments.

## 4.3 Overview of the signals and interfaces

Designed as a signal generator with various application fields, the R&S SMW200A uses a hardware concept that enables you to define and customize most of the input and output signals and interfaces. Depending on the selected fading and baseband configuration, the digital interfaces can be used as input or output connectors. The different logical settings of the same physical interface are grouped in different dialogs.

### Logical signals, streams and channels

This section provides background information and an introduction to the topics. The description is divided in parts that follow the logical decision process when configuring the instrument. It supports the manual configuration for simple test scenarios.

The settings provided in the "System Configuration" dialog guide you throughout this decision process automatically. For complex routing scenarios, like MIMO configuration and especially configuration involving several instruments, we recommend that you use the ["System Configuration"](#) functionality as a start and central configuration point.

For an overview of the interfaces and their characteristics, see the following sections:

- [Section 4.3.2, "Overview of the baseband signal sources"](#), on page 111
- [Section 4.3.3, "Overview of the baseband and RF output signals"](#), on page 112
- [Section 4.3.5, "Important signal parameters and interface characteristics"](#), on page 114

### 4.3.1 Physical location of the input and output interfaces

This section focuses on the input and output interfaces of the instrument. For a detailed overview of all front and rear panel connectors, see [Section 3.2, "Instrument tour"](#), on page 38.

#### Naming conventions and Show Connector function

The R&S SMW200A is a highly modular instrument. You can install different combinations of hardware and software options on the instrument. To increase the serviceability, the design of the different hardware boards is similar. But the complexity of the boards with its customizable connectors, signal types and signal directions can cause cabling faults and configuration faults. To simplify the cabling and to minimize this error source, it is important to identify the interfaces in any possible hardware and system configuration.

The instrument provides the following two methods for identifying the connectors:

- A connector naming rule that follows the predefined structure  
`<Board Name> <Number>[/<Hs Channel>][ <Direction>]`  
For example, the connector names "CODER 2 IN" or "BBMM 2 OUT".  
The `<Number>/<Hs Channel>` designation applies for the "HS DIG I/Q" connectors, for example "BBMM 1"/"BBMM 2".
- The built-in function "Show" or "Show Connector" indicates the selected connector location at the instrument with a blinking LED.



#### Connector notation synonyms

The descriptions use the short and long notation of the connector names synonymously where relevant, for example "COD 2 IN", "CODER 2 IN" or "Coder 2 IN".

#### Instrument boards and connector location

- The figures [Figure 4-1](#) and [Figure 4-2](#) show the digital interfaces on the rear panel for a fully equipped standard baseband instrument and a wideband baseband instrument. Also, the associated GUI terms are in orange color.



Figure 4-1: Standard baseband instrument rear panel: Digital input and output interfaces



Figure 4-2: Wideband baseband instrument rear panel: Digital input and output interfaces

- The figures Figure 4-3 and Figure 4-4 show the analog output interfaces on the rear panel for a fully equipped standard baseband instrument and a wideband baseband instrument. Also, the associated GUI terms are in orange color.



Figure 4-3: Standard baseband instrument rear panel: Analog output interfaces



Figure 4-4: Wideband baseband instrument rear panel: Analog output interfaces

See also "Input interface for the external digital baseband signal" on page 111 and "Input interface for the external analog signal" on page 112.

### Signal direction at the digital interfaces

The digital connectors "FADER 1" and "FADER 2" serve as input or output connectors. The selected fading and baseband configuration automatically predefines the direction of the required connectors, see "System Configuration LxMxN" on page 122.



If you change these predefined settings, cross-check the direction of the digital interface before you connect an external instrument.

See the following step-by-step instructions:

- ["To find out the correct connector"](#) on page 184 and ["Indication of the digital interface status"](#) on page 111
- ["To find out the connector's direction"](#) on page 184, if you operate the instrument remotely

#### Indication of the digital interface status

A dedicated LED indicates the connector status:

- ● green: an input connector
- ● yellow: an output connector
- ● no light / gray: the connector is not active

### 4.3.2 Overview of the baseband signal sources

The table [Table 4-3](#) provides an overview of the possible input I/Q signals and the input connectors (DIG I/Q or HS DIG I/Q) at the R&S SMW200A. The I/Q modulator can process each of these input signals and output them at the RF output connectors.

**Table 4-3: Physical I/Q input signals and GUI elements**

Input Signal	Input connector	GUI element	Related descriptions
Internal digital	-	"Baseband"	<a href="#">Section 5, "Configuring the internal baseband source"</a> , on page 215
External digital	CODER x FADER x HS DIG I/Q	"BB Input"	<a href="#">Section 4.6, "Digital baseband input settings"</a> , on page 151
External analog wideband	I/Q	"I/Q Mod"	<a href="#">Section 7, "Applying I/Q vector modulation"</a> , on page 458
External differential analog (in the first signal path)	I/Q Bar	"I/Q Mod"	<a href="#">Section 7, "Applying I/Q vector modulation"</a> , on page 458

See also [Section 4.3.4, "Supported digital interfaces and system configuration"](#), on page 113.

#### Input interface for the external digital baseband signal

The available interfaces depend on the installed options:

- *Standard baseband* (R&S SMW-B10)  
As shown in [Table 4-3](#), the instrument is equipped with **up to four digital interfaces (DIG I/Q)**, the CODER x and the FADER x connectors that can be used as **input for digital signals**.
- *Wideband baseband* (R&S SMW-B9)

The instrument provides two digital interfaces (DIG I/Q or CODER x) and two additional **high-speed digital interfaces** (HS DIG I/Q or HS CODER x), that can be used in the same way.



#### **Digital interface disabled in a particular system configuration (R&S SMW-B9)**

The DIG I/Q and the HS DIG I/Q are physically available, but disabled in a particular system configuration. Refer to [Section 4.3.4, "Supported digital interfaces and system configuration"](#), on page 113 for information on whether and which of the digital interfaces can be used.

The DIG I/Q digital interfaces provide direct communication with other Rohde & Schwarz instruments:

- Signal generators
- R&S EX-IQ-BOX external digital signal interface module
- R&S FSW signal and spectrum analyzer in radar echo generation applications
- R&S CMW500 radio communication tester in fading applications

See also:

- [Section 4.9.12, "How to connect an R&S EX-IQ-BOX"](#), on page 212
- [Section 4.9.10, "How to connect an R&S®CMW500 for fading applications"](#), on page 208

#### **Application examples of the external digital baseband signal**

Provided the instrument is equipped with the required options, in particular with at least two coder boards, the externally applied signals can be used for and further processed as follows:

- Used as a standalone baseband source and processed separately, e.g. faded, detuned, or loaded with noise or directly applied to the I/Q modulator
- Used as a user-specific wanted signal or interference signals to the internally generated signals
- In [Standard baseband](#), routed to one or to all the signal paths, added to the internally generated baseband signal possibly also frequency shifted
- Used as a baseband source for digital signals in test setups requiring more than four baseband signals (Tx antennas) or entities

#### **Input interface for the external analog signal**

The R&S SMW200A provides also an input interface for an external analog I/Q signal, a wideband or differential signal. The external signal is fed directly to the I/Q modulator. For a description of the related connectors and settings, see [Section 7, "Applying I/Q vector modulation"](#), on page 458 and [Table 7-1](#).

### **4.3.3 Overview of the baseband and RF output signals**

Usually, the generated baseband signal is modulated on the RF frequency and output at the RF connectors. For MIMO configurations with more than two RX antennas, how-



ever, the two RF output signals are not sufficient. For MIMO configurations, for test setups in which the R&S SMW200A acts as a baseband signal source or as a pure fading simulator, it also provides connectors to output the baseband signal. As shown in [Table 4-4](#), the R&S SMW200A outputs the digitally modulated signal directly or converted to an analog I/Q baseband output signal. The analog baseband signal can be output single-ended or differential (non-inverted). Also, you can generate an RF envelope signal.

The [Table 4-4](#) shows the possible output connectors with the corresponding kind of signal. Which logical information or stream is output at which connector is defined by the "I/Q Stream Mapper", see [Section 4.4.2, "I/Q stream mapper settings"](#), on page 127.

**Table 4-4: Physical output signals and GUI elements**

Output signal	Output connector	GUI element	Related descriptions
RF	RF	"RF"	<a href="#">Section 8, "Configuring the RF signal"</a> , on page 475
Digital I/Q	BBMM x FADER x HS BBMM x	"I/Q Digital" (DIG I/Q or HS DIG I/Q)	<a href="#">Section 4.7, "I/Q digital output settings"</a> , on page 164 See also <a href="#">Section 4.3.4, "Supported digital interfaces and system configuration"</a> , on page 113.
Analog I/Q <ul style="list-style-type: none"> <li>• Single-ended</li> <li>• Differential</li> <li>• RF Envelope</li> </ul>	Analog I/Q <ul style="list-style-type: none"> <li>• I/Q</li> <li>• I/Q Bar</li> <li>• I/I Bar</li> </ul>	"I/Q Analog"	<a href="#">Section 4.8, "I/Q analog output settings"</a> , on page 176

#### 4.3.4 Supported digital interfaces and system configuration

As listed in [Table 4-3](#) and [Table 4-4](#), the available digital interfaces depend on the installed options. Also, the configured system configuration determines which interfaces you can use.

See [table Table 4-5](#) for an overview. Also, the table lists the maximum clock frequency (sample rate) in each of the supported combinations.

**Table 4-5: R&S SMW-B9: System configuration, digital interfaces and maximum sample rate**

"System Config" > Mode	"System Config" > Signal Outputs	Digital	Inputs	Digital	Outputs*
		CODER x	HS CODER x	BBMM x	HS BBMM x
Standard	"Analog only"	-	1.25 GHz	-	-
	"Digital Only (HS)"	-	-	-	1.25 GHz
Advanced	"Analog & Digital"	250 MHz	-	250 MHz	-
	"Digital Only (HS)"	-	-	-	250 MHz
	"Analog & Digital (HS)"	250 MHz	-	-	1 GHz

\*) requires R&S SMW-K19.

### 4.3.5 Important signal parameters and interface characteristics

Correct signal processing of the externally supplied input signals in the instrument and correct processing of the output signal in the next connected instrument require information of signal parameters. These signal parameters are sampling rate, crest factor and signal level, expressed as peak or as RMS level value.

#### Sample rate

The sample rate of the digital input and output signal can be defined manually or automatically retrieved from the input and estimated for the output signal. The bandwidth and thus the sample rate of the digital input signal is not limited by the installed sample rate options.

For more information, refer to the specifications document.

#### Crest factor

According to its definition, the crest factor gives the difference in level between the peak level and RMS level value in dB (see [Figure 4-5](#)).

The R&S SMW200A uses the crest factor to calculate the power levels that is the instrument compensates the RMS levels of the externally supplied signal by the crest factor. For example, the crest factor of the external signal is important for the calculation of the RF output power.

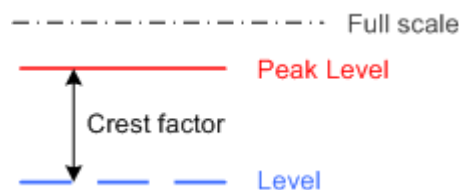

**Figure 4-5: Relation between the level settings**

Test setups often involve an upconverter connected to the I/Q connectors of the generator or feeding of external signal to the digital input of the R&S SMW200A. As a rule, whenever an I/Q signal is transferred between two instruments, *the crest factor and the peak levels of the two involved instruments have to be coordinated*.

To ensure proper signal settings and correct results, check if the peak level values and crest factor values are equal. Equal values hold for the I/Q outputs of the R&S SMW200A and the I/Q inputs of the upconverter are equal.

In the R&S SMW200A, level values are represented as relative to full-scale values (see [Figure 4-5](#)).



### Where to find the necessary values

- Dialog "BB Input"  
See [Section 4.6, "Digital baseband input settings"](#), on page 151
- Dialog "Digital I/Q Out"  
See [Section 4.7, "I/Q digital output settings"](#), on page 164
- Dialog "Analog I/Q Out"  
See [Section 4.8, "I/Q analog output settings"](#), on page 176
- Dialog "Setup > System > Baseband Powers", see [Section 9.2, "Querying baseband power levels"](#), on page 645
- Dialog "Fading > Insertion Loss Config / Coupled Parameters > Insertion Loss"

See user manual R&S®SMW-B14/-K71/-K72/-K73/-K74/-K75/-K820/-K821/-K822/-K823 Fading Simulation.

### Avoiding overflow of the input signal and output signal

Option: R&S SMW-B10

The R&S SMW200A constantly monitors the input and output digital signal and indicates an overflow status.

- Overflow of the **input signal** (crest factor and peak level) is indicated if the entered "Peak Level" (in dBFS) value does not correspond to the real value  
**Tip:** The overflow status is indicated as long as the signal level is not reduced and the peak level value corrected. Trigger "Auto Level Set" to collect the required values and adjusts the settings automatically.
- Overflow of the **output signal** is indicated if the digital signal is clipped, i.e. if the level of the output signal, or the noise level (AWGN) are too high.

#### 4.3.5.1 Specifics of the digital I/Q interfaces

##### Mapping digital channels to the baseband signal path

The external digital signals supplied at the DIG I/Q interfaces of the instrument can contain more than one, possibly even multiplexed, digital channels. The R&S SMW200A processes each of these digital channels as a separate signal.

The external digital signals supplied at the HS DIG I/Q interfaces of the instrument can contain more than one, possibly even multiplexed, digital channels. The R&S SMW200A processes each of these digital channels as a separate signal.

Over the settings provided at the user interface, you can route the available digital channels of each of the digital interface to one of the baseband blocks.



Do not mistake the term *channel* used here with the term [Fading channel](#) or signal path.

For a description of the required settings, see [Connector](#).

### Signal processing prerequisites for external baseband signals

This section focuses on the way that these requirements are fulfilled and explains how the instrument deals with signals deviating from the expected values:

- **Crest factor peak level and RMS level**

These values can be adjusted in one of the following ways:

- Adjusted manually  
If you have knowledge about these values, enter them directly.  
See also "[Crest Factor](#)" on page 157.
- Estimated automatically by the internal measurement function  
Use the function [Auto Level Set](#) to trigger the R&S SMW200A to measure the input signal, estimate the peak level and RMS level and calculate the crest factor out of them.

**Tip:** For a correct signal leveling:

- 1) Enable an appropriate measurement time.
- 2) Execute one measurement for each baseband source.
- 3) Set the measurement period to a time value that is long enough to capture several periods of the input signal.

- Determined automatically  
The R&S SMW200A can receive the values from the connected transmitter. If the external digital signal source is a second Rohde & Schwarz instrument, it signals the peak level and the RMS level of the signal over the digital input interface. To enable the R&S SMW200A to receive these values, enable the parameter "[DIG IQ Auto Setting](#)" on page 156.

In the second automatic way, the R&S SMW200A adjusts the corresponding input fields with the measured/received values. The internal gain control mechanism uses these received values to adjust the input signal gain to achieve an optimal dynamic range.

- **Sample rate**

External input signals with sample rates different than the system clock are resampled, as illustrated on [Figure 4-6](#).

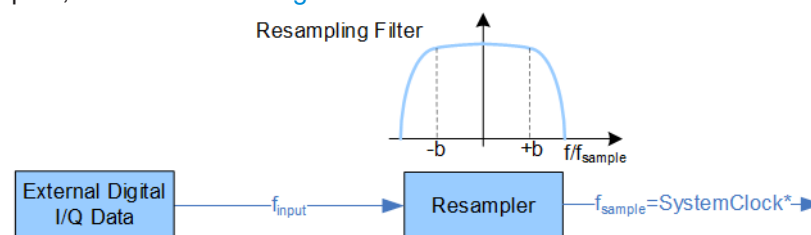

**Figure 4-6: Resampling principle of external digital baseband signals**

\* = Max. sample rate depends on connected device

$f_{input}$  = Max. sample rate

The max. sample rate depends on the installed options:

- The R&S SMW200A can process digital signals with sample rate  $f_{input} = 400$  Hz to 200 MHz.
- The [Wideband baseband](#) version working in standard mode uses, can process wideband digital signals with  $f_{input} \leq 2.4$  GHz.

The internal signal processing in the **Standard baseband** is based on a sample rate with a maximum value ( $f_{\text{sample, max}} = 200 \text{ MHz}$  or  $100 \text{ MHz}$ ) that depends on the capabilities of the connected transmitting/receiving device.

- **Maximum modulation bandwidth**

A baseband signal with a sample rate  $f_{\text{sample}} < f_{\text{sample, max}}$  (i.e. smaller than the used system clock) is interpolated, see [Figure 4-6](#). The resulting modulation bandwidth is calculated as *sample rate \* 0.8*.

With a sample rate  $f_{\text{sample, max}}$  of exactly 200 MHz, the modulation bandwidth in the **Standard baseband** is 160 MHz.



### Estimating or defining the sample rate

The sample rate of the signal at the digital interface can be determined with one of the following methods:

- **Estimated sample rate**

Enable the instrument to evaluate the received I/Q data clock

- **User-defined sample rate**

Provide both the external signal source and the receiving instrument with a common external reference signal and set the sample rate value.

#### 4.3.5.2 Specifics of the analog I/Q interfaces

The R&S SMW200A outputs the digitally modulated signal not only directly but also converted to an analog I/Q baseband output signal. The R&S SMW200A outputs the analog baseband signal single-ended or differential (non-inverted); an RF envelope signal can be generated, too.

#### Differential output signal

The differential output provides symmetrical signals for differential inputs of DUTs without the need of an additional external electric network. To achieve an optimal and balanced operating point of these inputs, ensure the correct adjustment of the used DC voltage ("Bias") and the offset ("Offset") between inverting and non-inverting output.

See also "[Bias \(EMF\)](#)" on page 181 and "[Offset \(EMF\)](#)" on page 181.

#### Maximum overall output voltage

The voltage of the analog output signals is defined as a combination of the output voltage of the I and Q signal components and an optional bias voltage. If you use the differential output, you can also set an offset.

The values of these parameters are interdependent so that the sum of output voltage and bias voltage has an upper limit  $V_{\text{max}}$  as follows:

- Single-ended signal:  $V_p + V_{\text{bias}} \leq 4 \text{ V}$
- Differential signal:  $0.5 \cdot V_p + |V_{\text{bias}}| + 0.5 \cdot V_{\text{offset}} \leq 4 \text{ V}$

Where:

- $V_p$  is the output voltage, see "[I/Q Level Vp \(EMF\)](#)" on page 180.

- $V_{\text{bias}}$  is the bias voltage, see ["Bias \(EMF\)"](#) on page 181.
- $V_{\text{offset}}$  is the offset between inverting and non-inverting output, see ["Offset \(EMF\)"](#) on page 181.

## 4.4 System configuration settings

The "System Configuration" dialog is the central point for the configuration of the signal flow. The provided settings assist you to fulfill your configuration tasks, like changing the selected MIMO mode or support you by connecting new devices to the baseband outputs.

The settings in this dialog comprise the fading configuration, the baseband source configuration, the mapping, and the processing of the generated I/Q streams. From this dialog, you can also control and configure the connections to instruments connected to the RF and I/Q connectors.

For a step-by-step description of how to use the provided settings, see [Section 4.9, "How to connect external instruments and configure the signal flow"](#), on page 182.

### Required options

The equipment layout for the generation of **complex signals** ([Standard baseband](#)) includes:

- 2 options standard baseband generator (R&S SMW-B10)  
(Including digital interfaces CODER 1/2 per R&S SMW-B10)
- Option baseband main module, two I/Q paths to RF (R&S SMW-B13T)
- Up to four options fading simulator (R&S SMW-B14)  
(Including one digital interface FADER 1/2/3/4 per installed option)
- Option MIMO fading (R&S SMW-K74)
- Optional option higher-order MIMO (R&S SMW-K75)
- Optional option multiple entities (R&S SMW-K76)
- Optional option [Slow IQ](#) (R&S SMW-K551)
- Optional option steam extender (R&S SMW-K550)
- Optional option MIMO subsets (R&S SMW-K821)

The equipment layout for the output of **wideband digital I/Q signals** includes:

- 2 options wideband baseband generator (R&S SMW-B9)  
(incl. digital interfaces CODER 1/2 and HS CODER 1/2 and per installed option)
- Option wideband baseband main module, two I/Q paths to RF (R&S SMW-B13XT)
- Up to four options fading simulator (R&S SMW-B15)
- Option wideband digital baseband outputs R&S SMW-K19

For a description of the "Multi-Instrument" settings, see [Section 10.3.1.1, "Multi-instrument settings"](#), on page 665.

**Settings:**

- [Fading and baseband configuration settings](#)..... 119
- [I/Q stream mapper settings](#)..... 127
- [External RF and I/Q settings](#)..... 129
- [External instrument configuration settings](#)..... 136
- [Overview](#)..... 145

**4.4.1 Fading and baseband configuration settings****Access:**

- ▶ Use one of the following:
  - In the taskbar, select "System Config" > "System Configuration" > "Fading/Baseband Config".
  - In the block diagram, select "Fading" > "System Configuration" > "Fading/Baseband Config".
  - In the block diagram, select "I/Q Stream Mapper" > "System Configuration" > "Fading/Baseband Config".
  - On the instrument front panel, press [SETUP].  
Select "System Configuration" > "Fading/Baseband Config".

The dialog comprises the settings required to configure the signal routing up to the "I/Q Stream Mapper". A preview diagram shows a detailed view of the signal processing for the currently selected configuration, together with a short description of the possible application of this configuration.

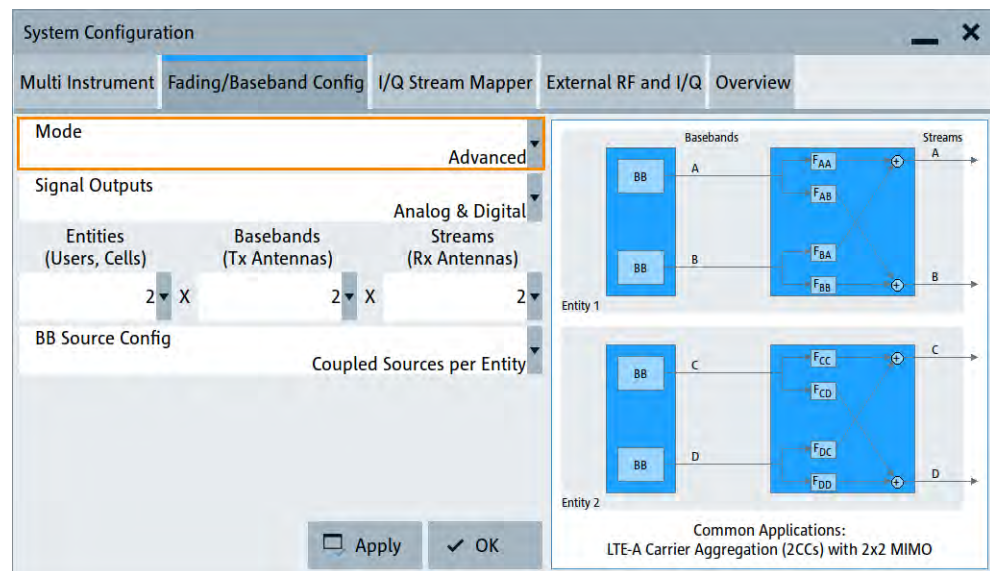

If you are familiar with other Rohde & Schwarz signal generators, like the R&S SMU, you expect that the block diagram displays the signal routing as it is done on the preview diagram. Consider, however, that if in "Fading/Baseband Configuration" > "Mode"

> "Standard" this behavior is assured, for higher MIMO modes in "Mode" > "Advanced" the block diagram is an abstract representation of the configuration.



This section focuses on the settings available in the "System Configuration" dialog. For further details about the fading functionality, refer to the user manual "Fading Simulator".

For step-by-step description on how to use the provided settings, refer to [Section 4.9.3, "How to define the MIMO scenario"](#), on page 185.

### Settings:

Mode.....	120
Signal Outputs.....	121
Signal Routing.....	122
System Configuration LxMxN.....	122
L Entities (Users, Cells).....	123
L Basebands (Tx Antennas).....	123
L Streams (Rx Antennas).....	124
Subset.....	124
BB Bandwidth.....	124
CA Bandwidth.....	125
BB Source Config.....	125
Duplicate Streams.....	125
HS Channels per.....	126
Set to Default.....	126
Apply.....	126
Ok.....	126

### Mode

Selects the system configuration modes.

Select "Apply" to apply settings that are specific to the selected system configuration mode.

"Standard"	<p>Provided for non-MIMO configuration.</p> <p>If <a href="#">Wideband baseband</a> is installed, wideband signals with a bandwidth of up to 2 GHz are generated.</p>
"Advanced"	<p>Depending on the <i>installed hardware and software options</i>, enables the configuration of:</p> <ul style="list-style-type: none"> <li>• Complex MxN MIMO scenarios with up to 8 TX or Rx antennas, e.g. 4x4, 2x8, or 8x2 MIMO</li> <li>• multiple entity scenarios with up to four standalone 2x2 MIMO systems, e.g. 4x2x2 scenarios</li> <li>• Up to 8 SISO systems, e.g. 8x1x1 scenarios</li> </ul> <p>See also:</p> <ul style="list-style-type: none"> <li>• <a href="#">Section 4.9.3, "How to define the MIMO scenario"</a>, on page 185</li> <li>• <a href="#">Section 4.9.8, "How to generate a 2x8 MIMO signal for BS tests"</a>, on page 203</li> <li>• The specifications document</li> </ul>



**"Radar Echo Generation (REG)"**

Requires R&S SMW-K78.

Enables the R&S SMW200A to work as a radar echo generator. The fading simulator is disabled.

See the user manual R&S®SMW-K78 Radar Echo Generation.

**"GNSS Advanced"**

Option: R&S SMW-B9

Transforms the R&S SMW200A to a GNSS simulator. The fading simulator is disabled.

See the user manual R&S®SMW Satellite Navigation.

**"Extended Sequencer Advanced"**

Requires R&S SMW-B15/-K315.

Enables the R&S SMW200A to work in an advanced extended sequencer mode. The fading simulator, the AWGN, the BB input and all baseband digital standards are disabled.

See user manual R&S SMW-K501/-K502/-K503/-K504/-K315 Extended and Real-Time Sequencing, Real-Time Control Interface, Extended Pulse Rate, Permanent Emitters.

**"Bandwidth Extension"**

Requires R&S SMW-B9 and R&S SMW-555.

Enables the R&S SMW200A to generate RF signals with an extended bandwidth. These signals typically have bandwidths above 2.4 GHz.

See the user manual R&S SMW-K555 Bandwidth Extension.

Remote command:

`:SCONfiguration:MODE` on page 975

**Signal Outputs**

Defines whether an analog and digital or digital only signal is generated.

The keyword (HS) indicates that the signal is routed to the HS DIG I/Q connectors. If this keyword is missing, the signal is routed to the DIG I/Q connectors.

Baseband generator	Mode	Signal Outputs	Description	Options
R&S SMW-B10	Standard Advanced	"Analog&Digital"	The instrument generates signals with a high data rate. Generated streams can be mapped to the analog connectors and to the DIG I/Q interfaces.	
	Advanced	"Digital Only"	Baseband signal can only be output as digital signal at the DIG I/Q interfaces. The baseband signal cannot be routed to the RF and I/Q analog output.  Analog signal generation is possible with external analog I/Q signals. Alternatively, you can generate continuous wave signals, analog modulated signals or RF signals in sweep or list mode.	R&S SMW-K18

Baseband generator	Mode	Signal Outputs	Description	Options
	Advanced	"Digital Only Multiplexed"	R&S SMW200A can process up to 4 multiplexed streams received over the same connector.  With options R&S SMW-B10 and R&S SMW-K551, the R&S SMW200A can also generate digital signals with reduced speed, depending on the device connected to the digital I/Q interfaces. The multiplexed streams are then mapped to the digital I/Q interfaces BBMM 1/2; the mapping is fixed.	R&S SMW-K18
R&S SMW-B9	Standard	"Analog Only"	Disables the digital outputs.	
		"Digital Only (HS)"	Works like "Digital Only" in <a href="#">Standard baseband</a> but the baseband signal is output at the HS DIG I/Q interface.	R&S SMW-K19
	Advanced	"Analog&Digital"	Generated streams can be mapped to the analog connectors and to the DIG I/Q interfaces.	
		"Digital Only (HS)"	Works like "Digital Only" in <a href="#">Standard baseband</a> but the baseband signal is output at the HS DIG I/Q interface.	R&S SMW-K19
		"Analog&Digital (HS)"	Generated streams can be mapped to the analog connectors and to the HS DIG I/Q interfaces.	R&S SMW-K19

See user manual R&S SMW-K551 Generation of Digital "Slow IQ" Signals.

See also [Section 4.3.4, "Supported digital interfaces and system configuration"](#), on page 113.

Remote command:

`:SCONfiguration:OUTPut:MODE` on page 976

### Signal Routing

Option: R&S SMW-B10

Defines the signal routing in *non-MIMO Standard mode*. In a fully equipped [Standard baseband](#) instrument, the following configurations are available:

- "A->A, B->B"
- "A->A, B->A"
- "A->B, B->B"
- "A->A and B, A->A and B"
- "B->A and B, B-> (open)"
- "A-> (open), B->A and B"

The preview diagram displays the signal routing for the selected configuration.

Execute "Apply" to trigger the instrument to adopt the current configuration.

Remote command:

`:SCONfiguration:FADing` on page 976

### System Configuration LxMxN

In [Advanced mode](#), the fading and baseband configuration LxMxN is determined by three parameters, "Entities", "BB Signals", and "Streams". The available configurations depend on the installed hardware and software options.

**Note:** The RF outputs are disabled, if you apply new [System Configuration LxMxN](#) and/or change the [BB Source Config](#).

For more information, refer to the specifications document.

### Entities (Users, Cells) ← System Configuration LxMxN

Defines the number of entities to be generated.

An entity is a *self-contained independent system*, consisting of its own baseband part with possible fading simulator and noise generator and an RF part. An example of an entity is a user/mobile station or a cell/base station in one digital standard (e.g. 3GPP FDD, EUTRA/LTE, etc.). The R&S SMW200A can generate the signals of up to 8 entities.

The [Table 4-6](#) shows the interdependency between the number of entities (L), the number of baseband signals (M) and the number of streams (N).

**Table 4-6: Available value ranges and allowed combinations**

Number of entities (L)	Number of basebands (Tx antennas) (M)	Number of streams (Rx antennas) (N)	BB Source Config
1	1 to 4	1 to 4	Separate, coupled
1	8	1, 2	Coupled
1	1, 2	8	Separate, coupled
1	8	8	Coupled
2	1, 2	1 to 4	Separate, Coupled/Coupled per entity
2	1 to 4	1, 2	Coupled/Coupled per entity
3 to 4	1, 2	1, 2	Coupled/Coupled per entity
5 to 8	1	1	Coupled

See also "[To simulate complex MxN MIMO scenarios](#)" on page 185.

**Tip:** Use the "System Configuration" > "Overview" tab to visualize the current stream mapping to the output interfaces.

Remote command:

See [:SCONfiguration:FADing](#) on page 976.

### Basebands (Tx Antennas) ← System Configuration LxMxN

Defines the number of baseband signals or TX antennas to be simulated per entity. If one entity is enabled, the R&S SMW200A can generate the signal of up to 8 TX antennas simultaneously (see [Table 4-6](#)).

Configurations with "BB Signals (Tx Antennas) > 4" are enabled only with internal baseband signal.

**Note:** Error message: "The selected configuration is not fully supported by the current firmware".

Some baseband and fading configurations require that the R&S SMW200A is equipped with hardware and software options or the selected configuration is not yet fully supported.

For more information, refer to the specifications document.

Remote command:

See [:SCONfiguration:FADing](#) on page 976.

### Streams (Rx Antennas) ← System Configuration LxMxN

Defines the number of streams or Rx antennas to be generated per entity. If one entity is enabled, the R&S SMW200A can generate the signal of up to 8 Rx antennas simultaneously (see [Table 4-6](#)).

Remote command:

Via [:SCONfiguration:FADing](#) on page 976

### Subset

Requires an LxMxN configuration "1x8x8" or "1x4x4".

Depending on the installed options, an 1x8x8 MIMO configuration or a 1x4x4 MIMO configuration with wider fading bandwidth can be generated by two R&S SMW200A signal generators or by a single instrument.

- |          |   |
|----------|---|
| "1", "2" | <p>Option: R&amp;S SMW-B14/B15 and R&amp;S SMW-K74/K75 + R&amp;S SMW-K821, in 1x4x4 MIMO case also R&amp;S SMW-K822</p> <p>In a MIMO configuration with two R&amp;S SMW200A signal generators, each of the instruments generates a subset of fading channels. For example, in an 1x8x8 MIMO configuration, 32 out of the total 64 fading channels.</p> <p>This parameter defines which fading channels from the MIMO matrix are calculated by the selected instrument. The "Subset" selected in each of the two connected instrument has to be different.</p> <p>See also <a href="#">Section 4.9.9, "How to generate a 8x8 MIMO signal with two R&amp;S SMW200A"</a>, on page 204.</p> |
| "All"    | <p>Option: R&amp;S SMW-B14/B15 and R&amp;S SMW-K74/K75</p> <p>An 1x8x8 MIMO configuration is generated with a single R&amp;S SMW200A.</p>   |

Remote command:

[:SCONfiguration:MIMO:SUBSet](#) on page 977

### BB Bandwidth

Requires R&S SMW-B15/-K822/-K823.

Sets the baseband signal bandwidth that the fading simulator supports.

The value range and the maximum available bandwidth depend on the installed options and the selected MIMO configuration.

For example:

- In MIMO configurations with fewer than 8 channels, the max. baseband bandwidth is 400 MHz.
- In MIMO configurations with fewer than 4 channels, the max. baseband bandwidth is 800 MHz.

For more information, refer to the specifications document.

Remote command:

[:SCONfiguration:BBBW](#) on page 978

**CA Bandwidth**

Option: R&S SMW-B15/-K822/-K823

Indicates the resulting channel aggregation (CA) bandwidth, calculated based on the MIMO configuration and the "BB Bandwidth".

The "CA Bandwidth" represents the signal bandwidth at the stream mapper.

For more information, refer to the specifications document.

Remote command:

`:SCONfiguration:CABW?` on page 979

**BB Source Config**

Determines whether coupled or separated baseband sources are used (see "[Coupled or separate baseband sources](#)" on page 107).

**Note:** The RF outputs are disabled, if you apply new [System Configuration LxMxN](#) and/or change the [BB Source Config](#).

"Separate Sources"      The signal in each baseband can be and has to be configured separately.

Separated baseband sources are required, whenever the test scenario involves:

- A mixture of internally generated and externally supplied baseband signals
- A mixture of internally generated signals according to different digital standards

"Coupled Sources"

Couples the baseband sources to one common baseband block. All required baseband signals are generated out of the same baseband source. This mode is supported by the "EUTRA/LTE" and "IEEE802.11 WLAN" digital standards, by the "ARB" and by applying external digital baseband signals.

Using coupled baseband sources is advantageous in complex test scenarios. These modes are enabled if a [System Configuration LxMxN](#) with  $L > 1$  and/or  $M > 1$  is selected.

In LxMxN configuration with  $L > 1$ , the baseband sources can also be coupled per entity.

"Coupled Sources per Entity"

Requires  $L > 1$  for the LxMxN configuration. Couples the baseband sources per entity.

Using coupled baseband sources is advantageous in complex test scenarios. These modes are enabled if a [System Configuration LxMxN](#) with  $L > 1$  and/or  $M > 1$  is selected.

Remote command:

`:SCONfiguration:BASEband:SOURce` on page 978

**Duplicate Streams**

Option: R&S SMW-K550

This parameter is enabled in the configurations 3x1x1 and 4x1x1.

In a 3x1x1 configuration, for example, there are 3 basebands and 3 streams per default. The first two basebands can generate signals with real-time data sources.

If "Duplicate Streams" > "On", created is a copy of each stream after baseband / fading block. Generated are 6 streams; 4 of them can use real-time data sources, for example to ensure non-truncated PN sequences.

The pair of streams created out of the same baseband are identical, in terms of content, power level and frequency. The streams are treated as individual streams in terms of adding AWGN and shifting within the available RF bandwidth.

This feature is useful, if your test setup requires a combination of max 4 signals with real-time data source and 4 ARB signals. For example, for performing GSM AM suppression tests according to 3GPP TS 51.021, chapter 8.

See user manual R&S SMW-K550 Stream Extender.

Remote command:

`:SCONfiguration:DUPLICATE[:STReam]` on page 980

### HS Channels per

Option: R&S SMW-B9

Sets the number of channels per digital interface, where the total number of enabled channels on all HS DIG I/Q interfaces must not exceed 8.

Remote command:

`:SCONfiguration:DIQ:BBMM1:CHANnels` on page 979

`:SCONfiguration:DIQ:BBMM2:CHANnels` on page 979

### Set to Default

Presets the signal routing in the baseband section and the fading configuration to the default state.

**Note:** Changing the system configuration triggers an instrument preset.

Remote command:

`:SCONfiguration:PRESet` on page 975

### Apply

Triggers the instrument to adopt the selected configuration.

**Note:** Changing the system configuration triggers an instrument preset.

**Note:** The RF outputs are disabled, if you apply new [System Configuration LxMxN](#) and/or change the [BB Source Config](#).

Remote command:

`:SCONfiguration:APPLY` on page 980

### Ok

Applies the configuration and exits the dialog.

**Note:** Changing the system configuration triggers an instrument preset.

Remote command:

`:SCONfiguration:APPLY` on page 980

### 4.4.2 I/Q stream mapper settings

Access:

- In the block diagram, select "I/Q Stream Mapper".

	Frequency Offs (Hz)	Phase Offs (*)	RF A	RF B	I/Q OUT 1	I/Q OUT 2	BBMM 1	BBMM 2	FAD 3	FAD 4
Stream A	-20 000 000.00	0.00	✓				✓			
Stream B	0.00	0.00		✓				✓		
Stream C	0.00	0.00			✓		✓		✓	
Stream D	-20 000 000.00	0.00				✓		✓		✓
Combination			Single	Single	Single	Single	Add	Add	Single	Single

Figure 4-7: I/Q Stream Mapper settings in a LxMxN configuration with four streams (standard baseband)

The dialog provides the settings for routing of the signal streams to the available output connectors, the analog RF and I/Q output, and the digital I/Q output connectors.

Meaning of the background colors:

- **Yellow:** Streams mapped to the RF, I/Q and the BBMM connectors can be added, possibly also frequency and phase shifted. At the BBMM connectors, streams can also be output multiplexed.
- **Gray:** The stream mapping to the FADER connectors is fixed. Only single streams can be mapped; frequency offset cannot be applied. If connect and control external instruments by the R&S SMW200A, the configured frequency offset applies to the RF signal of these instruments.

The settings are displayed in form of a stream matrix, where:

- The number of rows is equal to the number of the generated streams ("System Configuration > Fading/Baseband Configuration > Advanced Mode" and selected **Entities (Users, Cells)\*Streams (Rx Antennas)**)
- The column display only the available digital output interfaces ("System Configuration > External RF and I/Q > Direction > Out").

#### Settings:

$f_{\text{offset}}$ , MHz.....	127
Phase Offset.....	128
Map Stream X to Connector.....	128
Combination Mode.....	129

#### $f_{\text{offset}}$ , MHz

Option: R&S SMW-B9 - available if "Signal Outputs = Analog Only"

Sets an absolute frequency offset; streams routed to the RF, I/Q and BBMM connectors are shifted in the frequency domain.

Frequency offset is also applied to R&S SMBV and R&S SGT instruments connected to the FADER outputs.

**Tip:** Use this parameter:

- To shift the used frequency band in the RF frequency section without modifying the RF settings
- To separate streams in the frequency domain, if these streams are added and routed to the same output connector.

**Note:** The parameters "Baseband Offset" and "Frequency Offset" have different impact.

Both parameters shift the signal in the frequency domain, but only the  $f_{\text{offset}}$  affects the calculation of the "Doppler Shift".

If the fading simulator is used, do not apply a "Baseband Offset" but do use the "Frequency Offset" instead.

The value range depends on the following:

- Installed options (e.g. baseband generator and baseband extensions)
- "System Config > Fading/Baseband Config" > [Mode](#)
- "System Config > Fading/Baseband Config" > [Signal Outputs](#)

For more information, refer to the specifications document.

See also:

- "Fading Simulation" user manual, description of the parameter "Dedicated Frequency".
- "[Combination Mode](#)" on page 129.

Remote command:

[:SCONfiguration:OUTPut:MAPPING:STReam<st>:FOFFset](#) on page 981

### Phase Offset

Option: R&S SMW-B9 - available if "Signal Outputs = Analog Only"

Sets the phase offset of the corresponding stream.

Remote command:

[:SCONfiguration:OUTPut:MAPPING:STReam<st>:POFFset](#) on page 982

### Map Stream X to Connector

The mapping of the generated streams to the output connectors is represented as a stream matrix. A blue circle at a matrix element routes the selected stream to the corresponding connector.

To map more than one stream to an output connector, enable the [Combination Mode](#).

The stream mapping to the FADER connectors is fixed.

Remote command:

[:SCONfiguration:OUTPut:MAPPING:RF<ch>:STReam<st>:STATe](#) on page 981

[:SCONfiguration:OUTPut:MAPPING:IQOutput<ch>:STReam<st>:STATe](#)

on page 981

[:SCONfiguration:OUTPut:MAPPING:BBMM<ch>:STReam<st>:STATe](#)

on page 981



[:SCONfiguration:OUTPut:MAPPING:FADer<ch>:STReam<st>:STATe](#)

on page 981

[:SCONfiguration:OUTPut:MAPPING:BBMM<ch>:CHANnel<di>:STReam<st>:](#)

[STATe](#) on page 981

### Combination Mode

Defines the way that the streams are internally processed if multiple streams are routed to the same physical connector.

**Tip:** Use the parameter  $f_{\text{offset}}$ , MHz to shift the frequency bands of the streams in the frequency domain.

- "Single" One stream can be routed to several connectors but only one stream can be mapped on each connector.
- "Add" If you route more than one stream to the same RF, I/Q or BBMM connector, they are added equally weighted.
- "Mux" Option: R&S SMW-K18  
Enables stream multiplexing at the digital connectors. The exact parameters are defined in the "Digital I/Q Output" dialog.  
**Tip:** This mode is useful to output the generated signals of a higher-order MIMO configuration at less digital connectors. The connected instrument must support stream multiplexing.  
See [Section 4.7, "I/Q digital output settings"](#), on page 164

Remote command:

[:SCONfiguration:OUTPut:MAPPING:RF<ch>:MODE](#) on page 981

[:SCONfiguration:OUTPut:MAPPING:IQOutput<ch>:MODE](#) on page 981

[:SCONfiguration:OUTPut:MAPPING:BBMM<ch>:MODE](#) on page 981

[:SCONfiguration:OUTPut:MAPPING:FADer<ch>:MODE](#) on page 981

## 4.4.3 External RF and I/Q settings

A fully equipped R&S SMW200A can deliver up to 8 independent I/Q streams but can modulate only two of them to the RF domain using the internal RF paths. The remaining streams can be output at the analog or digital I/Q interfaces and led to the connected external RF signal generators.

### Prerequisites for connections to external instruments

Connecting external instruments to the R&S SMW200A requires the following signals and connections.

Signal	Interface	Remark
Control	LAN or USB	The control connection is enabled.
Input Output	Analog I/Q or digital I/Q Analog I/Q, digital I/Q or RF	The physical input signal or output signal is present at the interface.
Reference	Reference input or output	The external instrument and the R&S SMW200A have a common reference frequency signal.

### Accessing the external RF and I/Q settings

- ▶ On the taskbar, select "System Config" > "System Configuration" > "External RF and I/Q".

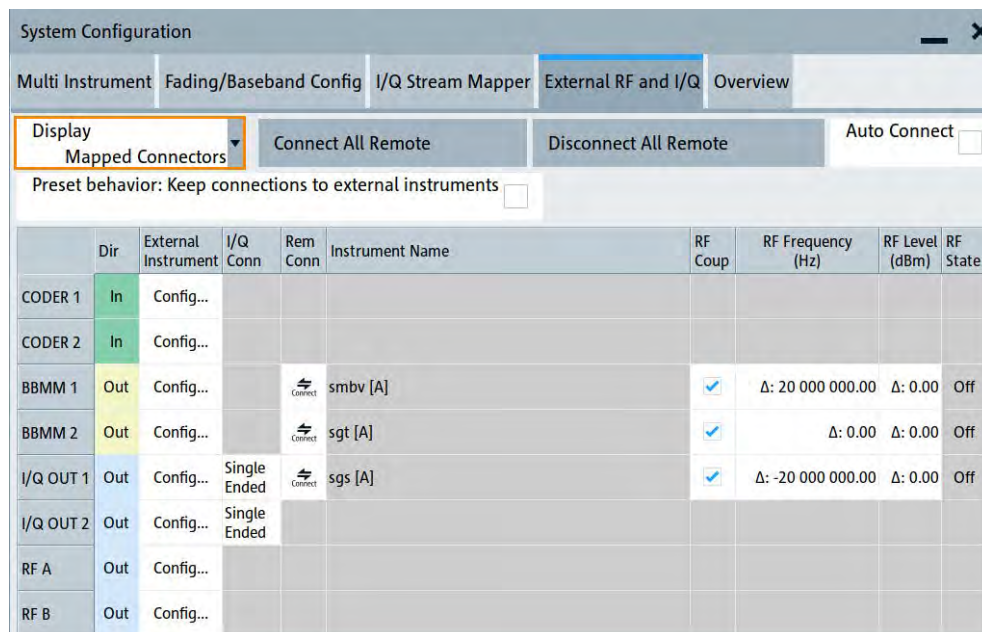

The dialog provides an overview of all available I/Q input and output connectors and comprises the settings necessary to establish the connection to the external instruments. Displayed is an overview of the currently connected external instruments together with relevant information like the connection status and the RF level and frequency that these external instruments use.

The dialog provides access to some additional short information on each of the connected instruments. It also provides a show connector function for an easy localization of the selected connector on the instrument front or rear panel.

For step-by-step instructions, see the following sections:

- [Section 4.9.5, "How to cable the instruments in MIMO test setups"](#), on page 188
- [Section 4.9.6, "How to connect and configure external instruments"](#), on page 189

#### Settings:

Display.....	131
Auto Connect.....	131
Connect/Disconnect All Remote.....	131
Preset behavior: Keep connections to external instruments.....	132
Connector Name.....	132
Direction.....	132
External Instrument.....	133
I/Q Connection.....	133
Remote Connection Status.....	133
Instrument Name.....	134

RF Couple.....	134
(Delta) RF Frequency/ RF Level.....	135
RF State.....	135

### Display

Filters the displayed connectors upon one of the following criteria:

"All Connectors"

No filter is applied.

"Mapped Connectors"

Displayed are only the connectors to which a stream is mapped.  
See "[Map Stream X to Connector](#)" on page 128.

**Note:** To prevent faults, use this filter before you further configure the external instruments.

"Input Connectors"/"Output Connectors"

Filters the display according to the connector direction.

Remote command:

`:SCONfiguration:EXTernal:DISPlay` on page 984

### Auto Connect

If enabled, the instrument automatically detects connected external instruments and establishes the required connection.

If the "Auto Connect" > "Off", however, after a R&S SMW200A startup you have to revise the test setup and perform the following:

- Check whether the necessary connections between the R&S SMW200A and the external instruments are still existing.
- Prove that the remote control of the particular instruments is required.
- Select "Connect All Remote" or "Disconnect All Remote".

Remote command:

`:SCONfiguration:EXTernal:ACONnect` on page 985

### Connect/Disconnect All Remote

Triggers the instrument to:

- Establish the remote connections to all configured external instruments.
- Terminate all existing remote connections.  
The external instruments are not removed from the list of external instruments.  
Only the remote connection status changes.

You can toggle the remote connection status with the parameter "Rem Conn".

**Note:** Disconnecting the remote connection to an R&S SZU presets several RF parameters of the R&S SMW200A to their default value.

This preset applies in particular to the RF frequency and RF level; the RF output is deactivated.

#### Note:

External instruments connected to the R&S SMW200A are preset (`:DEVice:PRESet`) whenever:

- The connection to the external instrument is established or terminated ("Connect/Disconnect All Remote" or "Rem. Conn > On/Off")
- The R&S SMW200A is preset ([PRESET]).

To ensure that the remote connections to the external instruments will be automatically established after instrument's start-up or a reboot, enable "Auto Connect > On".

See also:

- [Section 4.9.5, "How to cable the instruments in MIMO test setups"](#), on page 188
- [Section 4.9.6, "How to connect and configure external instruments"](#), on page 189.

Remote command:

`:SCONfiguration:EXTernal:REMOte:CONNect[:ALL]` on page 985

`:SCONfiguration:EXTernal:REMOte:DISConnect[:ALL]` on page 985

#### Preset behavior: Keep connections to external instruments

Sets the effect of R&S SMW200A preset ([PRESET] or \*RST) on the following:

- The connection status between the instrument and the connected external instruments.
- The R&S SMW200A itself and the preset values.
- The connected instruments.

"Preset behavior..."	Off	On
R&S SMW200A and preset values	Standard R&S SMW200A preset See <a href="#">Table 11-1</a> .	Depends on the connected external instrument: <ul style="list-style-type: none"> <li>• R&amp;S SZU RF = 60 GHz RF level = -30 dB RF &gt; Off</li> <li>• Otherwise, standard R&amp;S SMW200A preset. For example, RF = 1 GHz</li> </ul> Excluded from preset: <ul style="list-style-type: none"> <li>• "I/Q Output Type" <a href="#">See also</a></li> </ul>
Connection status	Terminated ("Disconnect All Remote")	Unchanged
Connected instruments	External instrument preset ( <code>:DEVIce:PRESet</code> )	External instrument preset

Remote command:

`:SCONfiguration:EXTernal:PBEHaviour` on page 985

#### Connector Name

Displays the connector name.

The dialog lists the connectors that are required for the current fading and baseband configuration.

See also:

- [Section 4.3.1, "Physical location of the input and output interfaces"](#), on page 109
- [Section 4.4.1, "Fading and baseband configuration settings"](#), on page 119
- [Section 4.3.4, "Supported digital interfaces and system configuration"](#), on page 113

Remote command:

Via keyword in the SCPI syntax, e.g. `IQOutput`

#### Direction

Displays the connector direction. Also the signal type (analog or digital) is color coded.

The availability of the connector depends on the connector state in the "I/Q Stream Mapper" dialog.

Remote command:

:SCONfiguration:EXTernal:CODer<ch>:DIRection? on page 986  
 :SCONfiguration:EXTernal:FADer<ch>:DIRection? on page 986  
 :SCONfiguration:EXTernal:BBMM<ch>:DIRection? on page 986  
 :SCONfiguration:EXTernal:IQOutput<ch>:DIRection? on page 986  
 :SCONfiguration:EXTernal:RF<ch>:DIRection? on page 986

### External Instrument

Opens a dialog with settings to establish the connection to the external instrument for the selected signal path.

See [Section 4.4.4, "External instrument configuration settings"](#), on page 136.

See also ["Prerequisites for connections to external instruments"](#) on page 129.



See also:

- [Section 4.9.5, "How to cable the instruments in MIMO test setups"](#), on page 188
- [Section 4.9.6, "How to connect and configure external instruments"](#), on page 189.

### I/Q Connection

Depends on the interface type:

- Analog I/Q interfaces:  
Selects the type of the I/Q output signal
- Digital I/Q interfaces:  
Indicates the status of the I/Q connection of the digital interfaces.  
The indication includes a status LED and an icon, where the icon depends on the connector (DIG I/Q or HS DIG I/Q) used.

Indication	Designation
 green LED and an icon	The DIG I/Q/HS DIG I/Q interface is used as an <b>input</b> connector
 yellow LED and an icon	The DIG I/Q/HS DIG I/Q interface is used as an <b>output</b> connector
 icon without an LED	An external instrument is connected to the DIG I/Q interface, but no direction is specified
No icon displayed	No connection
"Single Ended"/"Differential"	Selects the type of the I/Q output signal at the I/Q output connector Works like the parameter <a href="#">"I/Q Output Type"</a> on page 140.

Remote command:

:SCONfiguration:EXTernal:CODer<ch>:IQConnection:STATe? on page 987  
 :SCONfiguration:EXTernal:FADer<ch>:IQConnection:STATe? on page 987  
 :SCONfiguration:EXTernal:BBMM<ch>:IQConnection:STATe? on page 987

### Remote Connection Status

Indicates the status of the remote connection. Click the status indicator to toggle the remote connection status.

**Note:**

External instruments connected to the R&S SMW200A are preset (:DEvice:PRESet) whenever:

- The connection to the external instrument is established or terminated ("Connect/Disconnect All Remote" or "Rem. Conn > On/Off")
- The R&S SMW200A is preset ([PRESET]).

**Note:** An active "Rem. Conn." and an "RF State" > "On" do not mean that an I/Q stream is mapped to this connector.

Use the "System Configuration > External Rf and I/Q > Display > Mapped Connectors" filter to list only the connectors with a mapped I/Q stream.

Remote command:

:SCONfiguration:EXTernal:CODer<ch>:RCONnection:STATe? on page 987

:SCONfiguration:EXTernal:CODer<ch>:REMOte:DISConnect on page 994

:SCONfiguration:EXTernal:CODer<ch>:REMOte:INFO? on page 993

:SCONfiguration:EXTernal:FADer<ch>:RCONnection:STATe? on page 987

:SCONfiguration:EXTernal:FADer<ch>:REMOte:DISConnect on page 994

:SCONfiguration:EXTernal:FADer<ch>:REMOte:INFO? on page 993

:SCONfiguration:EXTernal:BBMM<ch>:RCONnection:STATe? on page 987

:SCONfiguration:EXTernal:BBMM<ch>:REMOte:DISConnect on page 994

:SCONfiguration:EXTernal:BBMM<ch>:REMOte:INFO? on page 993

:SCONfiguration:EXTernal:IQOutput<ch>:RCONnection:STATe?

on page 987

:SCONfiguration:EXTernal:IQOutput<ch>:REMOte:DISConnect

on page 994

:SCONfiguration:EXTernal:IQOutput<ch>:REMOte:INFO? on page 994

:SCONfiguration:EXTernal:RF<ch>:RCONnection:STATe? on page 987

:SCONfiguration:EXTernal:RF<ch>:REMOte:DISConnect on page 994

:SCONfiguration:EXTernal:RF<ch>:REMOte:INFO? on page 994

### Instrument Name

Displays useful information on the connected external instrument, like the instrument designation and the RF path the RF settings are coupled to.

Remote command:

:SCONfiguration:EXTernal:CODer<ch>:INAME? on page 987

:SCONfiguration:EXTernal:CODer<ch>:REMOte:INFO? on page 993

:SCONfiguration:EXTernal:FADer<ch>:INAME? on page 987

:SCONfiguration:EXTernal:FADer<ch>:REMOte:INFO? on page 993

:SCONfiguration:EXTernal:BBMM<ch>:INAME? on page 987

:SCONfiguration:EXTernal:BBMM<ch>:REMOte:INFO? on page 993

:SCONfiguration:EXTernal:IQOutput<ch>:INAME? on page 987

:SCONfiguration:EXTernal:IQOutput<ch>:REMOte:INFO? on page 994

:SCONfiguration:EXTernal:RF<ch>:INAME? on page 987

:SCONfiguration:EXTernal:RF<ch>:REMOte:INFO? on page 994

### RF Couple

If enabled, this parameter couples all major RF settings (like the "RF Frequency", the "RF Level" and the "RF State") of the external instrument to the R&S SMW200A.

The R&S SMW200A acts as a primary instrument. Connected external instruments synchronize their settings and the RF output state to the R&S SMW200A. You can apply delta frequency and level offset to the signal.

Remote command:

:SCONfiguration:EXTernal:FADer<ch>:RF:COUPling on page 988  
 :SCONfiguration:EXTernal:BBMM<ch>:RF:COUPling on page 988  
 :SCONfiguration:EXTernal:IQOutput<ch>:RF:COUPling on page 988  
 :SCONfiguration:EXTernal:RF<ch>:RF:COUPling on page 988

### (Delta) RF Frequency/ RF Level

In uncoupled mode, sets the RF frequency and RF level of the external instrument.

With enabled "RF Coupled" parameter, applies a frequency and level offset. The RF frequency of the external instrument is calculated as follows:

$$RF_{ExtInstr} = RF_{Instrument} + \Delta_{Freq}$$

Both the RF frequency and the RF frequency offset are applied at the external instrument.

Remote command:

:SCONfiguration:EXTernal:FADer<ch>:RF:FREQuency on page 988  
 :SCONfiguration:EXTernal:FADer<ch>:RF:FREQuency:OFFSet on page 988  
 :SCONfiguration:EXTernal:FADer<ch>:RF:POWer on page 989  
 :SCONfiguration:EXTernal:FADer<ch>:RF:POWer:OFFSet on page 989  
 :SCONfiguration:EXTernal:BBMM<ch>:RF:FREQuency on page 988  
 :SCONfiguration:EXTernal:BBMM<ch>:RF:FREQuency:OFFSet on page 988  
 :SCONfiguration:EXTernal:BBMM<ch>:RF:POWer on page 989  
 :SCONfiguration:EXTernal:BBMM<ch>:RF:POWer:OFFSet on page 989  
 :SCONfiguration:EXTernal:IQOutput<ch>:RF:FREQuency on page 988  
 :SCONfiguration:EXTernal:IQOutput<ch>:RF:FREQuency:OFFSet on page 988  
 :SCONfiguration:EXTernal:IQOutput<ch>:RF:POWer on page 989  
 :SCONfiguration:EXTernal:IQOutput<ch>:RF:POWer:OFFSet on page 989  
 :SCONfiguration:EXTernal:RF<ch>:RF:FREQuency on page 988  
 :SCONfiguration:EXTernal:RF<ch>:RF:FREQuency:OFFSet on page 988  
 :SCONfiguration:EXTernal:RF<ch>:RF:POWer on page 989  
 :SCONfiguration:EXTernal:RF<ch>:RF:POWer:OFFSet on page 989

### RF State

With enabled "RF Coupled" parameter, displays the RF output state of the connected external instrument. The parameter is coupled to the state of the RF output of the R&S SMW200A.

In uncoupled mode, enables/disables the RF output in the external instrument.

Remote command:

:SCONfiguration:EXTernal:FADer<ch>:RF:STATe on page 990  
 :SCONfiguration:EXTernal:BBMM<ch>:IQConnection:STATe? on page 987  
 :SCONfiguration:EXTernal:IQOutput<ch>:RF:STATe on page 990  
 :SCONfiguration:EXTernal:RF<ch>:RF:STATe on page 990

#### 4.4.4 External instrument configuration settings

Access:

1. On the taskbar, select "System Config" > "System Configuration".
2. Select "External RF and I/Q" > "External Instrument" > "Config...".

The dialog provides settings to configure the connection to the external instrument and to control the external instrument. Also you can find out the related connector at the R&S SMW200A.

Settings:

- [Remote instrument settings](#)..... 136
- [Remote control settings](#)..... 142
- [Show connector](#)..... 144
- [Connections settings](#)..... 144

##### 4.4.4.1 Remote instrument settings

Access:

1. Select "External RF and I/Q" > "External Instrument" > "Config...".
2. Select "Remote Instrument".

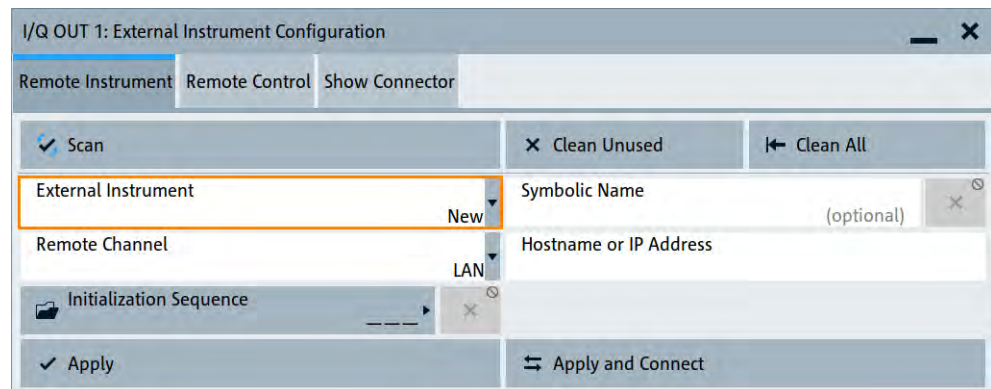

The tab provides settings to configure the connection settings of the remote instrument.

Settings:

- [Detect](#)..... 137
- [Scan](#)..... 137
- [Clean Unused/Clean All](#)..... 137
- [External Instrument](#)..... 138
- [Set Symbolic Name](#)..... 138
- [Remote Channel](#)..... 138



Remote Channel.....	139
Hostname or IP Address.....	139
Device ID.....	139
RF Path.....	140
I/Q Output Type.....	140
Frontend Configuration.....	140
Initialization Sequence.....	141
Remove Initialization Sequence.....	141
Apply.....	141
Apply and Connect.....	142

### Detect

Requires an external instrument connected to the digital I/Q interface of the R&S SMW200A.

Searches for these external instruments via the LAN or USB control interface. If detected, the "External Instrument" selection lists the external instrument including its configuration for the remote control connection.

**Note:** The first initialization of a connection to an external instrument can last several minutes. During the initialization procedure, you cannot search for the external instrument.

Remote command:

`:SCONfiguration:EXTernal:CODer<ch>:REMote:DETECT?` on page 992

`:SCONfiguration:EXTernal:FADer<ch>:REMote:DETECT?` on page 992

`:SCONfiguration:EXTernal:BBMM<ch>:REMote:DETECT?` on page 992

### Scan

Searches for external instruments via the remote control interface, for example, via the LAN interface. If detected, the "External Instrument" selection lists the external instrument including its configuration for the remote control connection.

The R&S SMW200A can search, for example, the following instruments:

R&S SMW, R&S SMM100A, R&S SMBV100B, R&S SMCV100B, R&S SGS, R&S SGT or external frontends

**Note:** The scan function searches throughout the entire network and can last several minutes.

The first initialization of a connection to an external instrument can last several minutes. During the initialization procedure, you cannot search for the external instrument.

Remote command:

`:SCONfiguration:EXTernal:REMote:SCAN` on page 990

`:SCONfiguration:EXTernal:REMote:SCAN:STATE?` on page 990

### Clean Unused/Clean All

Removes partly or fully the configuration of external instruments the R&S SMW200A controls via the LAN interface.

This function does not affect USB control connections.

**"Clean Unused"**

Removes external instrument configurations from unused LAN connections. The configurations for used LAN connections remain. These connections are the enabled and configured control connections. Also, this function allows you to update the external instruments list for a new pool of valid instruments.

Remote command:

`:SCONfiguration:EXTernal:REMote:PURGe` on page 995

**"Clean All"**

Disconnects and removes all connections of configured external instruments. Also removes all instruments from the list of external instruments.

Remote command:

`:SCONfiguration:EXTernal:REMote:CLEan` on page 995

**External Instrument**

Lists all available instruments, found by the [Scan](#) function.

To connect an external instrument, use one of the following:

- Enable "Select Instrument > New" and configure the settings manually
- Select "Select Instrument", navigate through the pool of available instruments, and select the required. The required settings are retrieved and updated automatically.

Select "None" to disable the connection.

Execute "Apply" to confirm the settings.

Remote command:

`:SCONfiguration:EXTernal:REMote:LIST?` on page 991

`:SCONfiguration:EXTernal:REMote:ADD` on page 991

`:SCONfiguration:EXTernal:CODer<ch>:REMote:ISElect` on page 992

`:SCONfiguration:EXTernal:FADer<ch>:REMote:ISElect` on page 992

`:SCONfiguration:EXTernal:BBMM<ch>:REMote:ISElect` on page 992

`:SCONfiguration:EXTernal:IQOutput<ch>:REMote:ISElect` on page 992

`:SCONfiguration:EXTernal:RF<ch>:REMote:ISElect` on page 992

**Set Symbolic Name**

Sets the alias name of the instrument.

Remote command:

`:SCONfiguration:EXTernal:REMote:ADD` on page 991

`:SCONfiguration:EXTernal:CODer<ch>:REMote:INFO?` on page 993

`:SCONfiguration:EXTernal:FADer<ch>:REMote:INFO?` on page 993

`:SCONfiguration:EXTernal:CODer<ch>:REMote:INFO?` on page 993

`:SCONfiguration:EXTernal:IQOutput<ch>:REMote:INFO?` on page 994

`:SCONfiguration:EXTernal:RF<ch>:REMote:INFO?` on page 994

**Remote Channel**

Displays or selects the remote or hardware channel for control of the external instrument.

"LAN" Control via the LAN interface.

"USB" Control via the USB interface.

**"Frontend Connection"**

Fixed remote channel for control of external frontends via the LAN interface.

**Remote command:**

`:SCONfiguration:EXTernal:REMote:ADD` on page 991  
`:SCONfiguration:EXTernal:CODer<ch>:REMote:INFO?` on page 993  
`:SCONfiguration:EXTernal:FADer<ch>:REMote:INFO?` on page 993  
`:SCONfiguration:EXTernal:CODer<ch>:REMote:INFO?` on page 993  
`:SCONfiguration:EXTernal:IQOutput<ch>:REMote:INFO?` on page 994  
`:SCONfiguration:EXTernal:RF<ch>:REMote:INFO?` on page 994  
`:SCONfiguration:EXTernal:RF<ch>:REMote:INFO?` on page 994

**Remote Channel**

Displays or selects the remote or hardware channel for control of the external instrument.

"LAN" Control via the LAN interface.

"USB" Control via the USB interface.

**"Frontend Connection"**

Fixed remote channel for control of external frontends via the LAN interface.

**Remote command:**

`:SCONfiguration:EXTernal:REMote:ADD` on page 991  
`:SCONfiguration:EXTernal:CODer<ch>:REMote:INFO?` on page 993  
`:SCONfiguration:EXTernal:FADer<ch>:REMote:INFO?` on page 993  
`:SCONfiguration:EXTernal:CODer<ch>:REMote:INFO?` on page 993  
`:SCONfiguration:EXTernal:IQOutput<ch>:REMote:INFO?` on page 994  
`:SCONfiguration:EXTernal:RF<ch>:REMote:INFO?` on page 994  
`:SCONfiguration:EXTernal:RF<ch>:REMote:INFO?` on page 994

**Hostname or IP Address**

Displays or sets the hostname or IP address of the connected external instrument.

See also "[Prerequisites for connections to external instruments](#)" on page 129.

**Remote command:**

`:SCONfiguration:EXTernal:REMote:ADD` on page 991  
`:SCONfiguration:EXTernal:CODer<ch>:REMote:INFO?` on page 993  
`:SCONfiguration:EXTernal:FADer<ch>:REMote:INFO?` on page 993  
`:SCONfiguration:EXTernal:CODer<ch>:REMote:INFO?` on page 993  
`:SCONfiguration:EXTernal:IQOutput<ch>:REMote:INFO?` on page 994  
`:SCONfiguration:EXTernal:RF<ch>:REMote:INFO?` on page 994

**Device ID**

Sets/displays the device identifier that is a unique string with the following structure:

`<frontend type>-<serial number>`

For a defined "External Instrument", the information is read out automatically.

Remote command:

`:SCONfiguration:EXTernal:REMOte:ADD` on page 991

`:SCONfiguration:EXTernal:RF<ch>:REMOte:INFO?` on page 994

### RF Path

In a two-path instrument, determines the RF output to be used.

Remote command:

`:SCONfiguration:EXTernal:REMOte:ADD` on page 991

`:SCONfiguration:EXTernal:CODer<ch>:REMOte:INFO?` on page 993

`:SCONfiguration:EXTernal:FADer<ch>:REMOte:INFO?` on page 993

`:SCONfiguration:EXTernal:CODer<ch>:REMOte:INFO?` on page 993

`:SCONfiguration:EXTernal:IQOutput<ch>:REMOte:INFO?` on page 994

`:SCONfiguration:EXTernal:RF<ch>:REMOte:INFO?` on page 994

### I/Q Output Type

Selects the type of output signal.

The parameters in the "I/Q Analog Outputs" dialog depend on the selected output mode.

- "Single-Ended"
- If "RF Envelope" > "Off", uses a single-ended output at the I/Q connectors.  
Option: R&S SMW-B9: the signal from "I/Q Analog B" is output at the I Bar connectors.  
See [Figure 4-3](#) and [Figure 4-4](#).
  - If "RF Envelope" > "On", the envelope signal is output at the I connectors.

You can define a bias between the output signal and the ground.

- "Differential"
- Option: R&S SMW-B10 and R&S SMW-K16  
Or R&S SMW-B9 and R&S SMW-K17.
- If "RF Envelope" > "Off", the analog I/Q signal components are output at the I/Q and I/Q Bar connectors.  
See [Figure 4-3](#) and [Figure 4-4](#).  
Option: R&S SMW-B9: the differential signal output can be activated in "I/Q Analog A" block only. Single-ended and differential signals cannot be output simultaneously.
  - If "RF Envelope" > "On", the inverted envelope signal  $\bar{E}$  is output at the I Bar connectors.

Remote command:

`[ :SOURce<hw> ] :IQ:OUTPut [ :ANALog ] :TYPE` on page 1215

### Frontend Configuration

Requires R&S SMW-K553.

Accesses the "RF Frontend" dialog to configure settings of the connected external frontend.

For more information, see the document "R&S SMW-K553 Frontend Control User Manual".

**Initialization Sequence**

Accesses the standard "File Select" dialog for loading an existing initialization file (extension \*.iec).

When you establish the connection to an external instrument ("Rem Conn" is active), the R&S SMW200A performs the following:

- Sends the command `:DEVIce:PRESet`
- Sends the content of the initialization sequence file to reconfigure the external instrument

If necessary, perform further settings and configuration of the external instruments.

**Tip:** Try out also the following:

- Send individual SCPI commands or a sequence of SCPI commands to the connected instruments or define your own initialization sequence and load the file  
See ["To create a remote control sequence or modify the initialization sequence"](#) on page 194
- If you are configuring the R&S SMW200A remotely from a controller, try out to remote control the connected R&S SGS/R&S SGT via the R&S SMW200A.  
See:
  - [Example "Controlling multiple instruments with the same application program"](#) on page 969
  - [Example "Connecting an external instrument and sending SCPI commands"](#) on page 971

Remote command:

`:SCONfiguration:EXTernal:REMote:INITialization:CATalog?`

on page 994

`:SCONfiguration:EXTernal:CODer<ch>:REMote:INITialization:FILE`

on page 995

`:SCONfiguration:EXTernal:FADer<ch>:REMote:INITialization:FILE`

on page 995

`:SCONfiguration:EXTernal:BBMM<ch>:REMote:INITialization:FILE`

on page 995

`:SCONfiguration:EXTernal:IQOutput<ch>:REMote:INITialization:FILE`

on page 995

`:SCONfiguration:EXTernal:RF<ch>:REMote:INITialization:FILE`

on page 995

**Remove Initialization Sequence**

Deletes the loaded sequence.

**Apply**

Confirms the settings and displays the external instrument in the "External RF and I/Q" dialog.

Remote command:

`:SCONfiguration:EXTernal:CODer<ch>:REMote:ISElect` on page 992

`:SCONfiguration:EXTernal:FADer<ch>:REMote:ISElect` on page 992

`:SCONfiguration:EXTernal:BBMM<ch>:REMote:ISElect` on page 992

`:SCONfiguration:EXTernal:IQOutput<ch>:REMote:ISElect` on page 992

`:SCONfiguration:EXTernal:RF<ch>:REMote:ISElect` on page 992

### Apply and Connect

Confirms the settings and triggers the connection establishment. In the connected instruments, the status of this active remote connection is displayed by the "Remote" indication.

Remote command:

:SCONfiguration:EXTernal:CODer<ch>:REMote:ISElect on page 992  
 :SCONfiguration:EXTernal:CODer<ch>:REMote:CONNECT on page 993  
 :SCONfiguration:EXTernal:FADer<ch>:REMote:ISElect on page 992  
 :SCONfiguration:EXTernal:FADer<ch>:REMote:CONNECT on page 993  
 :SCONfiguration:EXTernal:BBMM<ch>:REMote:ISElect on page 992  
 :SCONfiguration:EXTernal:BBMM<ch>:REMote:CONNECT on page 993  
 :SCONfiguration:EXTernal:IQOutput<ch>:REMote:ISElect on page 992  
 :SCONfiguration:EXTernal:IQOutput<ch>:REMote:CONNECT on page 993  
 :SCONfiguration:EXTernal:RF<ch>:REMote:ISElect on page 992  
 :SCONfiguration:EXTernal:RF<ch>:REMote:CONNECT on page 993

#### 4.4.4.2 Remote control settings

Access:

1. Select "External RF and I/Q" > "External Instrument" > "Config..."
2. Select "Remote Control".

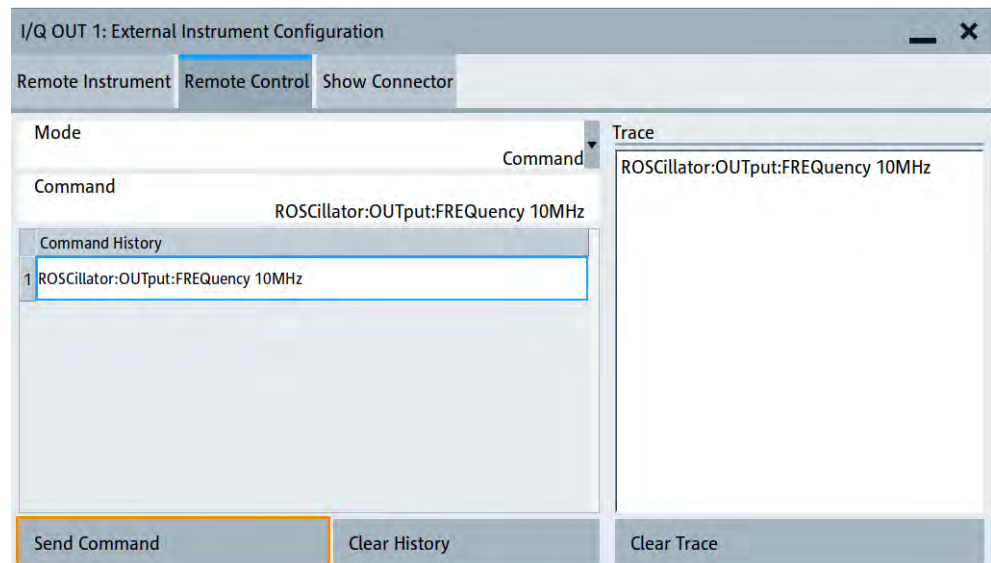

In this dialog, you can send individual SCPI commands or a sequence of SCPI commands to the connected instruments.

The sent commands and their results are displayed in the "Command Trace" field, as long as the trace is not deleted "Clear Trace". The sent commands are also listed in the "History" list. As long as this history list is not deleted ("Clear History"), you can select a command from the list and send it again.

See also:

- ["To create a remote control sequence or modify the initialization sequence"](#) on page 194
- [Example "Controlling multiple instruments with the same application program"](#) on page 969.

### Settings:

<a href="#">Mode</a> .....	143
<a href="#">Command/Send Command</a> .....	143
<a href="#">File/Command Sequence/Send Sequence</a> .....	143
<a href="#">Command History/Clear History</a> .....	143
<a href="#">Trace/Clear Trace</a> .....	144

### Mode

You can send a single command ("Command") or a command sequence ("Sequence") to the connected instrument.

### Command/Send Command

Entry field for the SCPI commands.

You can enter a new command or select a previously sent command from the "History".

If the remote connection is active, select "Send Command" to execute the command.

Remote command:

- [:SCONfiguration:EXTernal:CODer<ch>:REMote:SEND](#) on page 995
- [:SCONfiguration:EXTernal:BBMM<ch>:REMote:SEND](#) on page 995
- [:SCONfiguration:EXTernal:FADer<ch>:REMote:SEND](#) on page 995
- [:SCONfiguration:EXTernal:IQOutput<ch>:REMote:SEND](#) on page 995
- [:SCONfiguration:EXTernal:RF<ch>:REMote:SEND](#) on page 995

### File/Command Sequence/Send Sequence

Opens the standard "File Select" dialog for loading of user-defined files with extension \*.iec.

The provided navigation possibilities in the dialog are self-explanatory.

When a file is selected, its name and content are displayed, and the first command is selected. You can send the commands one by one ("Send Command") or send the entire sequence at once ("Send Sequence").

After a command is sent, the next command from the sequence is selected.

See also:

- ["To create a remote control sequence or modify the initialization sequence"](#) on page 194
- ["Initialization Sequence"](#) on page 141
- [Section 11.5.1, "File select settings"](#), on page 714.

### Command History/Clear History

List of the sent commands.

As long as this history list is not cleared ("Clear History"), you can select a command from the list and send it again.

#### Trace/Clear Trace

List of the sent commands and their results, where the results are displayed in blue color.

To delete the trace, select "Clear Trace".

#### 4.4.4.3 Show connector

Access:

1. Select "Taskbar > System Config > System Configuration > External RF and I/Q".
2. Navigate to the required connector.  
Select "External Instruments > Config ...".
3. In the "<Dig. Conn. Name>: External Instrument Configuration" dialog, select "Show Connector".

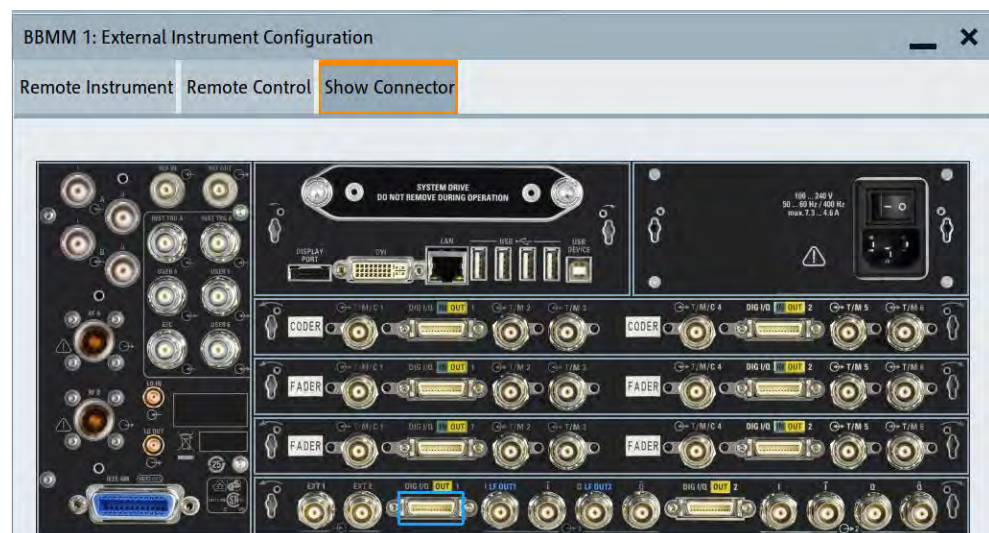

The dialog displays the location of the selected connector.

The "Show Connector" function triggers the instrument to identify the connector on the rear panel. The LED next to the selected connector blinks.

See also [Section 4.3.1, "Physical location of the input and output interfaces"](#), on page 109.

#### 4.4.4.4 Connections settings

Displaying the settings requires an enabled control connection between an R&S SZU and the R&S SMW200A, see ["To connect and configure an R&S SZU"](#) on page 195.



Access:

1. Select "External RF and I/Q" > "I/Q OUT x" > "External Instrument" > "Config...".
2. In the "I/Q OUT x: External Instrument Configuration" dialog, select "Connections".

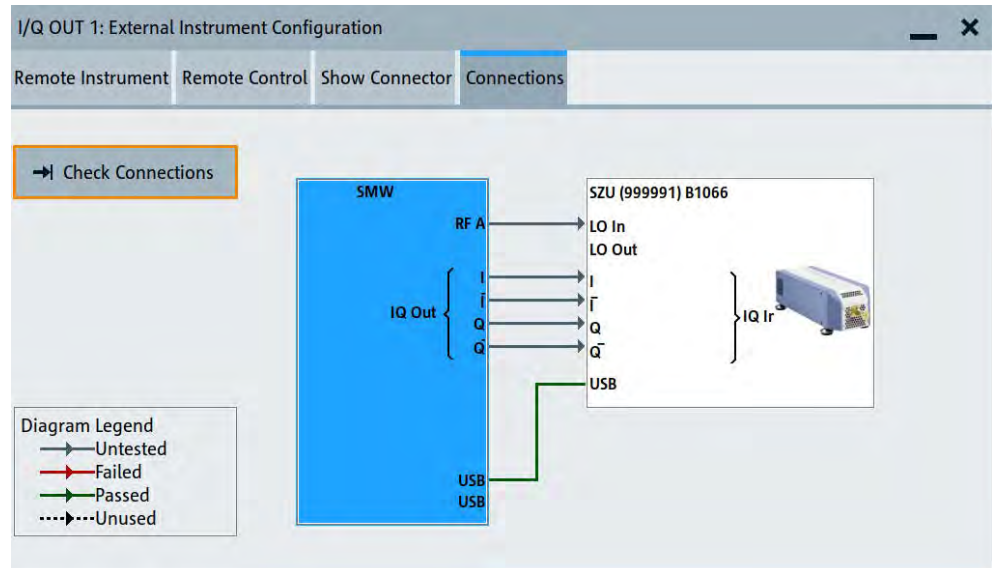

The dialog is a graphical representation of the required connections and their status. The connection status indication is color coded.

The dialog shows information on the following:

- Connection check status
- Signal connections status
- Remote control connections status

### Settings:

#### Check Connections

Triggers a check of all connections between the R&S SZU and the R&S SMW200A.

Remote command:

`:SCONfiguration:EXTernal:IQOutput<ch>:CONNECTIONS:CHECK?`

on page 996

## 4.4.5 Overview

Access:

- ▶ Select "System Configuration" > "Overview".

The overview tab shows information on the following:

- Current stream mapping to the output interfaces, see [Section 4.4.2, "I/Q stream mapper settings"](#), on page 127.
- Connected controller (external PC).

- Connections for remote control of connected external I/Q and RF devices, see [Section 4.4.3, "External RF and I/Q settings"](#), on page 129
- Input and output signals, like:
  - LO coupling or used external reference frequency.
  - Connected external baseband source to the digital input interface.

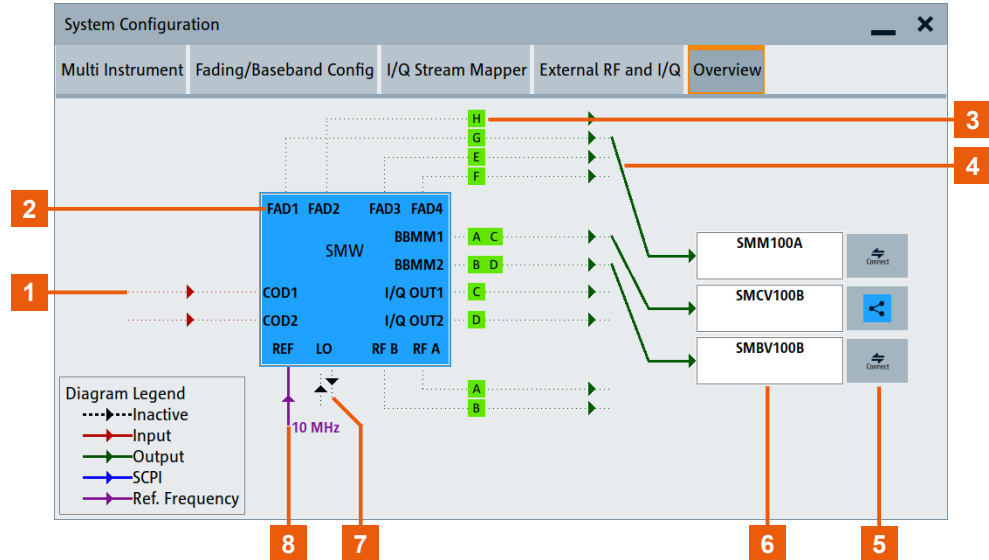

- 1 = Inactive I/Q input signals at the COD1/COD2 interfaces
- 2 = Interface at the R&S SMW200A for signal input or signal output
- 3 = Signal stream "H" and signal direction
- 4 = Active I/Q output signal path "G" routed to an external instrument
- 5 = Remote connection state of the external instrument
- 6 = Configured external instrument with its symbolic name
- 7 = Inactive input signal and output signal of a local oscillator (LO)
- 8 = Active external reference frequency input signal

Compare the overview representation with the example configuration in [External RF and I/Q settings](#).

### Hotspots for fast access to the required settings

Several of the displayed elements are hotspots. Select one of the elements listed in [Table 4-7](#) to access the related dialog.

**Table 4-7: Overview dialog hotspots**

GUI element	Dialog	Related description
"COD1"/"COD2" or the associated stream	"Baseband Input Settings"	See <a href="#">Section 4.6, "Digital baseband input settings"</a> , on page 151
"I/Q OUT1"/"I/Q OUT2" or the associated stream	"I/Q Analog Outputs"	See <a href="#">Section 4.8, "I/Q analog output settings"</a> , on page 176
"BBMM1"/"BBMM2" "FAD3"/"FAD4" or the associated stream	"I/Q Digital Outputs"	See <a href="#">Section 4.7, "I/Q digital output settings"</a> , on page 164

GUI element	Dialog	Related description
"FAD1"/"FAD2" or the associated stream	Depends on the current configuration and whether the digital interface acts as input or as output:  "Baseband Input Settings"  "I/Q Digital Outputs"	See <a href="#">Section 4.6, "Digital baseband input settings"</a> , on page 151  See <a href="#">Section 4.7, "I/Q digital output settings"</a> , on page 164
"RF A"/"RF B" or the associated stream	"I/Q Modulator"	See <a href="#">Section 7.4, "I/Q modulator settings"</a> , on page 466
Icon of a connected external instrument	"External Instrument Configuration"	See <a href="#">Section 4.4.4, "External instrument configuration settings"</a> , on page 136
"REF"	"Reference Frequency"	See <a href="#">Section 8.8, "Reference oscillator"</a> , on page 491.
"LO"	"LO Coupling"	See <a href="#">Section 8.9, "Local oscillator coupling"</a> , on page 500

## 4.5 Signal routing settings

### Required options

- 2 options Standard Baseband Generator (R&S SMW-B10)

### Signal routing in standard mode

In [Standard mode](#), the signal routing settings are a routing possibility suitable for straightforward non-MIMO configurations. If you are familiar with other Rohde & Schwarz signal generators, e.g. the R&S SMU or R&S AMU, these settings provide a convenient way to configure the signal flow. Consider, however, that the number of the possible configurations is rather limited. To experience the whole routing performance of the instrument, use the more advanced configurations (see [Section 4.4, "System configuration settings"](#), on page 118).



### Other possibilities to configure the signal flow

The "Signal Routing" settings are just one of several methods that you can use to configure the signal flow and route the signal throughout the instrument. Refer to [Section 4.2, "Possible ways to configure the signal flow"](#), on page 105 for an overview of all other ways and their common application fields.

In the default state of the instrument, i.e. in **"System Configuration > Mode = Standard"**, the baseband internal and external signals can be routed as defined in the [Table 4-8](#).

As shown in the table:

- The internal baseband signal can be introduced into path A, path B or both

- The external baseband signal of the first input module "BB Input A" can be fed into path A, path B or both
- The second baseband input module "BB Input B" is firmly connected to signal path B
- If internal signals from one path or two-paths are generated at the same time, all signals in each path are summed.

**Table 4-8: Possible baseband signal routing combinations (default instrument state)**

Block in the block diagram	To path A	To path B	To path A and B
"Baseband A"	X	X	X
"Baseband B"	X	X	X
"BB Input A"	X	X	X
"BB Input B"		X	



### "Signal Routing" and "System Configuration"

The signal routing settings are enabled for the following configurations:

- "System Configuration > Mode = Standard"
- "System Configuration > Mode = Advanced" with maximum two "Separate Baseband Sources", e.g. in 1x2x2, 2x1x1 or 2x1x2 configurations  
See also ["Short representations of fading and baseband configurations"](#) on page 102.

For an overview of the signal routing possibilities of the faded baseband signal, refer to [Section 4.4.1, "Fading and baseband configuration settings"](#), on page 119.

**Example: Baseband and fading signal routing in standard mode**

The Figure 4-8 shows an example of the signal flow for the following signal routing settings:

- "Baseband A" > "Signal Routing" > "route to path A and B"
- "Baseband B" > "Signal Routing" > "route to path A and B"
- "BB Input A" > "Signal Routing" > "route to path A and B"
- "BB Input B" > "Signal Routing" > "route to path B"
- "Fading" > "System Configuration" > "Mode" = "Standard" > "System Configuration" > "A to A and B, B to A and B"

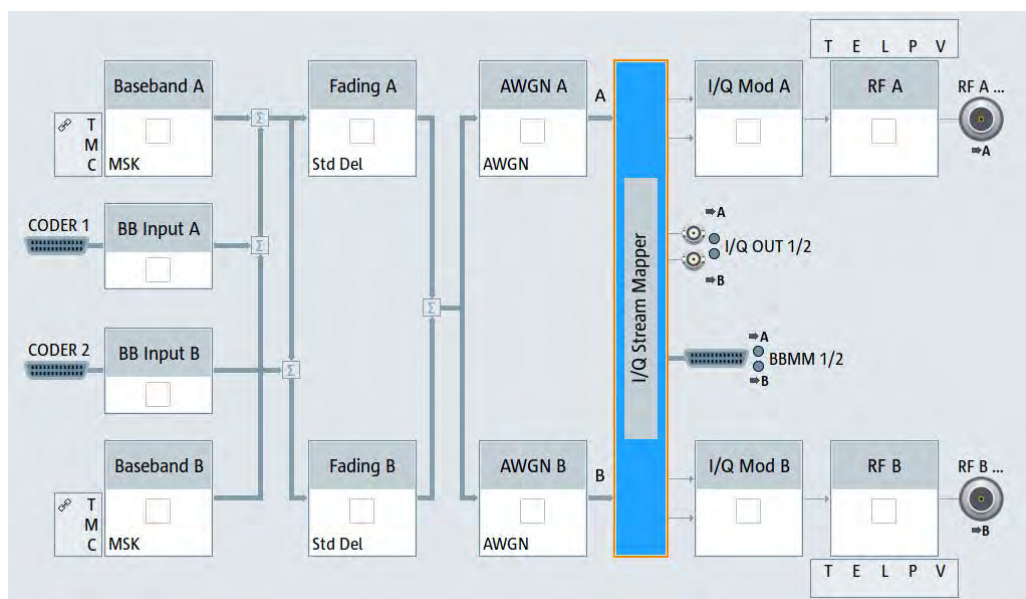

Figure 4-8: Example: Baseband and fading signal routing in standard mode

**Example: Routing the signal of baseband A to the RF B output**

The Figure 4-9 shows an example of the signal flow for the following settings:

- "IQ Stream Mapper" > "Stream A to RF B"
- "Baseband A" > "State" > "On"
- "RF B" > "State" > "On"

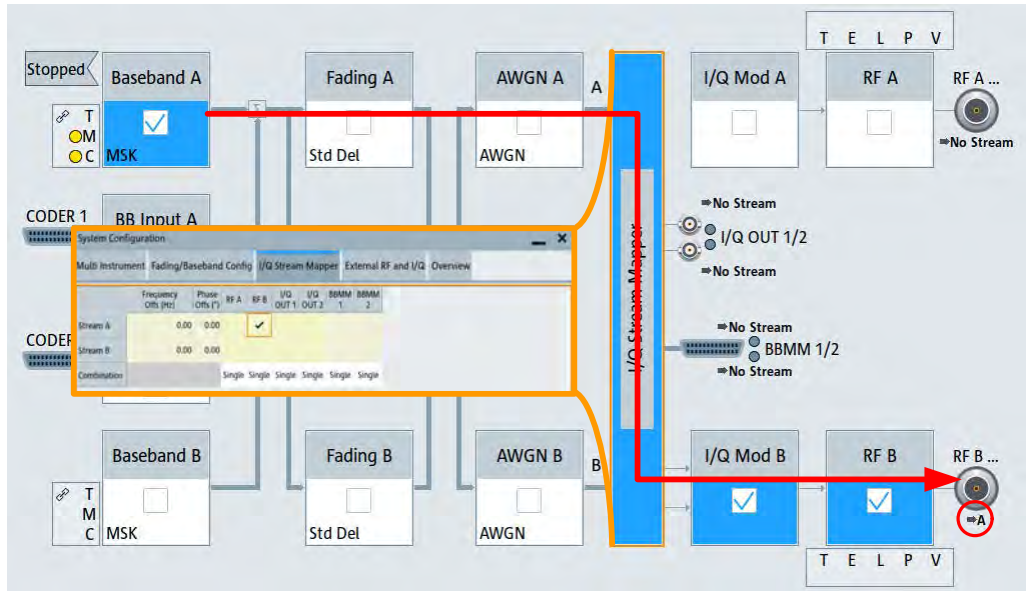
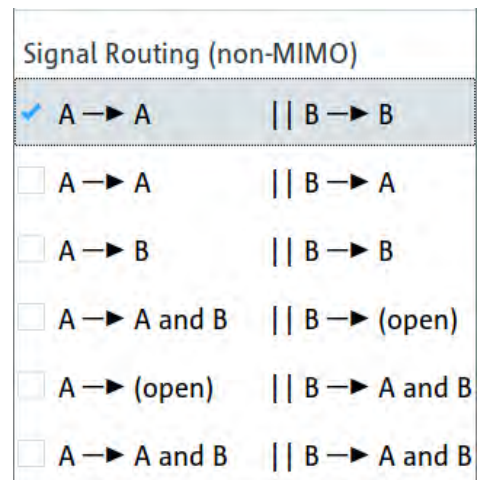
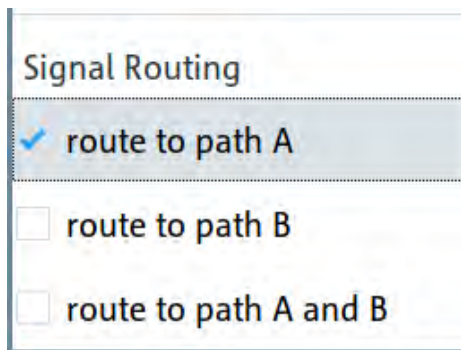

Figure 4-9: Example: Routing the signal of baseband A to the RF B output

**Accessing signal routing settings**

- ▶ Select one of the following:
  - Select "Baseband A"/"Baseband B" > "Signal Routing".
  - Select "BB Input A"/"BB Input B" > "Signal Routing".
  - Select "Fading" > "Signal Routing (non-MIMO)".



**Settings:****Signal Routing**

Requires R&S SMW-B10.

Defines the way the baseband signal (internally generated or externally provided) is routed in the instrument. When routing more than one signal to the same path, the signals are summed.

"route to path A"

The internal or external baseband signal is routed to path A.

"route to path B"

The internal or external baseband signal is routed to path B.

"route to path A and B"

The internal or external baseband signal is routed to both paths.

Remote command:

[ :SOURce<hw> ] :BB:ROUTe on page 1059

[ :SOURce<hw> ] :BBIN:ROUTe on page 1059

## 4.6 Digital baseband input settings

The R&S SMW200A provides interfaces to feed an **external digital baseband signal** into the signal path.

**Required Options**

The equipment layout for applying an external baseband signal includes:

- Option standard or wideband baseband generator (R&S SMW-B10/-B9) per signal path (including one digital interface per installed option)
- Optional, option fading simulator (R&S SMW-B14) (including one digital interface per installed option)
- Optional, option customized digital input (R&S SMW-K556) per R&S SMW-B9 for input of wideband I/Q signals with configurable sample rate.

For more information, refer to the specifications document.

The remote commands required to define these settings are described in [Section 14.19.3, "SOURce:BBIN subsystem"](#), on page 1026.

- [Baseband input settings in the standard baseband generator](#)..... 151
- [Baseband input settings in the wideband baseband generator](#)..... 158

### 4.6.1 Baseband input settings in the standard baseband generator

Option: R&S SMW-B10

### To access and configure the "Baseband Input Settings" (Standard baseband instrument)

The **"BB Input"** block provides access to the settings for signal routing, frequency offset and path gain, and to the available configuration parameters of the external signal.

The digital baseband input interfaces **DIG I/Q** are located on the R&S SMW200A rear panel, see [Section 4.3.1, "Physical location of the input and output interfaces"](#), on page 109.

In the default instrument state, the block diagram displays the connector in an unfolded state. The digital input interfaces are inactive (gray LEDs).

1. To display the "BB Input" block, select the symbol "CODER 1/2".

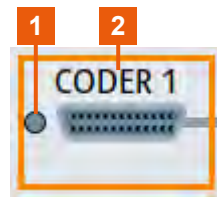
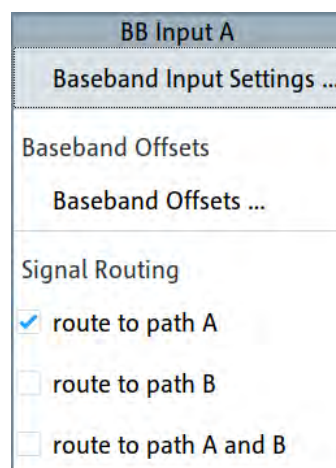

Figure 4-10: Representation of the digital baseband input interface DIG I/Q

1 = Digital input interface state: gray = inactive; blue = active  
2 = Connector name

2. To access the routing settings, select "BB Input" > "Signal Routing".  
See [Section 4, "Signal routing and system configuration"](#), on page 100.
3. To access the frequency offset and path gain settings, select "BB Input" > "Baseband Offsets".  
See [Section 5.14, "Shifting the baseband signal"](#), on page 418.
4. To access the dialog box for configuring the external signal input depending on the current "System Configuration" > "Fading/Baseband Config", select "BB Input" > "Baseband Input Settings".





The "Baseband Input Settings" dialog provides settings necessary to define the used connector, and to adjust the signal parameters, like the sample rate and the baseband input level.

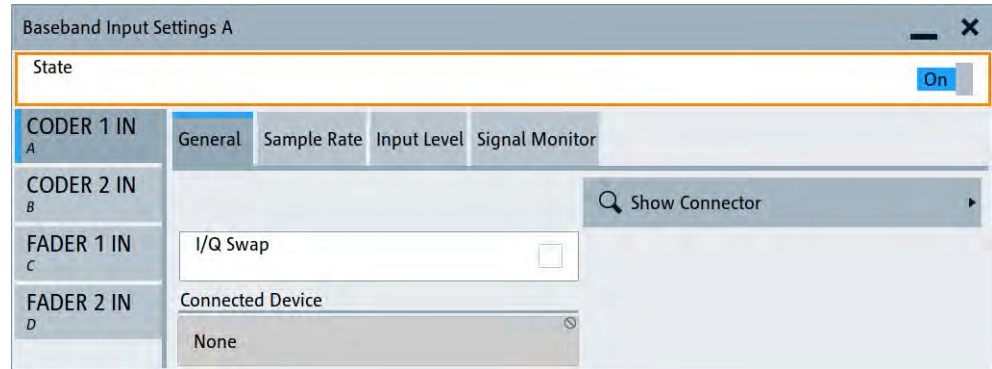

Figure 4-11: Baseband input settings in 1x4x4 configuration (standard baseband)

If the current instrument configuration uses **Coupled sources**, the dialog consists of **up to four side tabs**, whereas the number of tabs corresponds to the number of selected **Basebands (Tx Antennas)**. The tab name displays the baseband that the settings are related to and the connector the digital input signal is provided at.

- To enable the input signal, select "BB Input" > "On".

#### Settings:

- [General settings](#)..... 153
- [Sample rate settings](#)..... 154
- [Input level settings](#)..... 156
- [Signal monitor settings](#)..... 157

#### 4.6.1.1 General settings

Option: R&S SMW-B10

Access:

- ▶ Select "BB Input" > "Digital I/Q In" > "Baseband Input Settings".

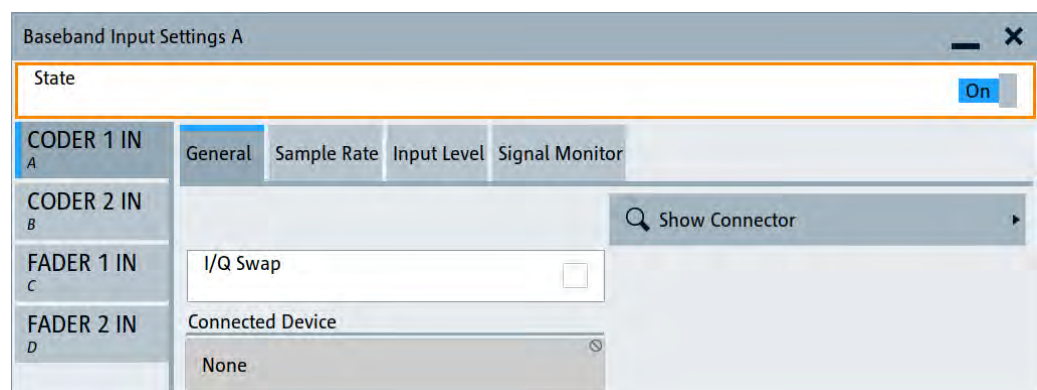

**Settings:**

State.....	154
Connector.....	154
I/Q Swap.....	154
Connected Device.....	154

**State**

Enables the feeding of the selected external digital signals into the baseband.

Remote command:

[ :SOURce<hw> ] :BBIN:STATe on page 1028

**Connector**

Defines the connector used as an external signal source.

Available are all digital input connectors, as defined with "System Configuration" > "External RF and I/Q" > "Direction" > "Input". See "[Direction](#)" on page 132.

"FADER 1 IN"/"FADER 2 IN"

Option: R&S SMW-B14

Remote command:

[ :SOURce<hw> ] :BBIN:DIGital:SOURce on page 1028

**I/Q Swap**

Option: R&S SMW-B10

Activates swapping of the I and Q signal components, see "[I/Q Swap](#)" on page 468.

**Tip:** The I/Q swap is required in test setups, like for example, if an external CDMA2000® or 1xEV-DO signal is added to an internally generated baseband signal.

See also:

- Description "CDMA2000® incl. EV-DV Digital Standard for R&S SMW200A"
- Description "1xEV-DO Rev. A, Rev. B Digital Standard for R&S SMW200A"

Remote command:

[ :SOURce<hw> ] :BBIN:IQSWap [ :STATe ] on page 1031

**Connected Device**

If the connection to the external device is properly established and signal transmission is active, this parameter displays information on the instrument connected to the DIG I/Q interface:

- Name, serial number and port of the connected instrument
- The transmitter sample rate, if supported by the transmitter

"None" indicates that no device is connected.

Remote command:

[ :SOURce<hw> ] :BBIN:CDEvice? on page 1029

**4.6.1.2 Sample rate settings**

Option: R&S SMW-B10

Access:

- ▶ Select "BB Input" > "Digital I/Q In" > "Baseband Input Settings" > "Sample Rate".

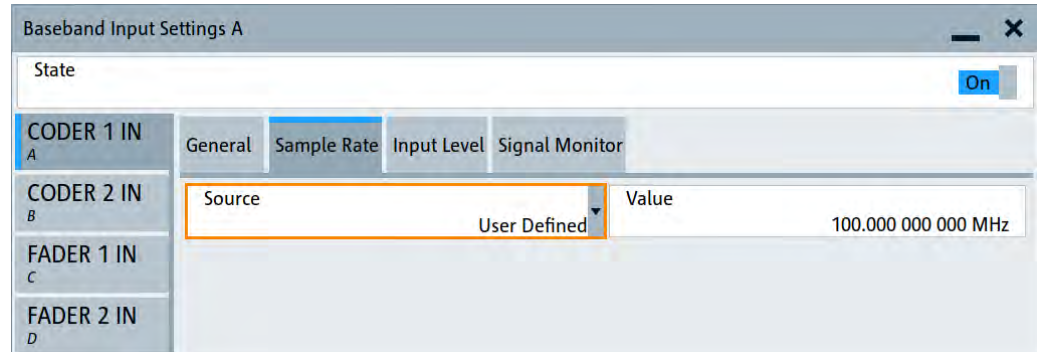

### Settings:

Sample Rate Source.....	155
Sample Rate Value.....	156

### Sample Rate Source

Selects whether the sample rate is estimated based on the digital input signal or is a manually entered value.

(See also [Section 4.3.5, "Important signal parameters and interface characteristics"](#), on page 114).

"Digital I/Q In"

For CODER connectors:

Estimates the sample rate based on the applied I/Q data clock and displays the resulting value in the value field. The I/Q data clock signal is fed via the DIG I/Q input.

**Note:** Estimation works best if the sample rate is close to the user-defined value.

"HS Digital I/Q In"

Option: R&S SMW-B9

Estimates the sample rate value based on the information transmitted by the transmitter.

Resulting value per channel is displayed by the parameter [Sample Rate](#).

"User Defined" The sample rate is as defined the entry field value.

**Note:** An I/Q data clock is not necessary but the external signal source (typically a second Rohde & Schwarz Instrument). Also, the signal source instrument and the signal sink instrument receiving have to use common external reference signal.

Remote command:

[ :SOURce<hw> ] :BBIN:SRATe:SOURce on page 1032

**Sample Rate Value**

For DIG I/Q connectors, sets the sample rate of the external digital baseband input signal.

The max. sample rate depends on the connected transmitting device.

Remote command:

[ :SOURce<hw> ] :BBIN:SRATe [ :ACTual ] on page 1033

**4.6.1.3 Input level settings**

Option: R&S SMW-B10

Access:

► Select "BB Input" > "Digital I/Q In" > "Baseband Input Settings" > "Input Level".

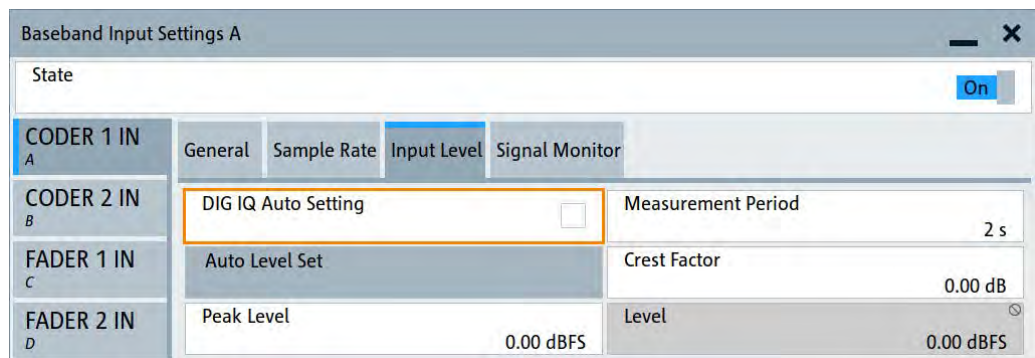
**Settings:**

DIG IQ Auto Setting.....	156
Measurement Period.....	156
Auto Level Set.....	157
Crest Factor.....	157
Peak Level.....	157
Level.....	157

**DIG IQ Auto Setting**

Activates an automatic adjustment of the baseband input signal.

The R&S SMW200A receives peak level, level and crest factor values directly from the connected transmitter and recognizes changes automatically.

Remote command:

[ :SOURce<hw> ] :BBIN:DIGital:ASETting:STATe on page 1033

**Measurement Period**

For CODER connectors:

Sets the recording duration for measuring the baseband input signal by "Auto Level Set".

**Note:** For accurate level measurements, set the measurement period to a time value that is long enough to capture several periods of the input signal.

Remote command:

[\[:SOURce<hw>\]:BBIN:MPERiod](#) on page 1033

#### Auto Level Set

For CODER connectors:

Starts measuring the input signal for estimating the crest factor, the peak level, and the Relevel of the input signal.

See also ["Signal processing prerequisites for external baseband signals"](#) on page 116.

Remote command:

[\[:SOURce<hw>\]:BBIN:ALEVel:EXECute](#) on page 1034

#### Crest Factor

Indicates the crest factor of the external baseband signal.

See also [Section 4.3.5, "Important signal parameters and interface characteristics"](#), on page 114.

Remote command:

[\[:SOURce<hw>\]:BBIN:POWer:CFACTOR](#) on page 1034

#### Peak Level

Indicates the peak level of the external baseband signal relative to full scale of 0.5 V (in terms of dB full scale).

See also [Section 4.3.5, "Important signal parameters and interface characteristics"](#), on page 114.

Remote command:

[\[:SOURce<hw>\]:BBIN:POWer:PEAK](#) on page 1034

#### Level

Indicates the estimated RMS level acquired with "Auto Level Set".

Remote command:

[\[:SOURce<hw>\]:BBIN:POWer:RMS?](#) on page 1035

#### 4.6.1.4 Signal monitor settings

Option: R&S SMW-B10

Access:

- ▶ Select "BB Input" > "Digital I/Q In" > "Baseband Input Settings" > "Signal Monitor".

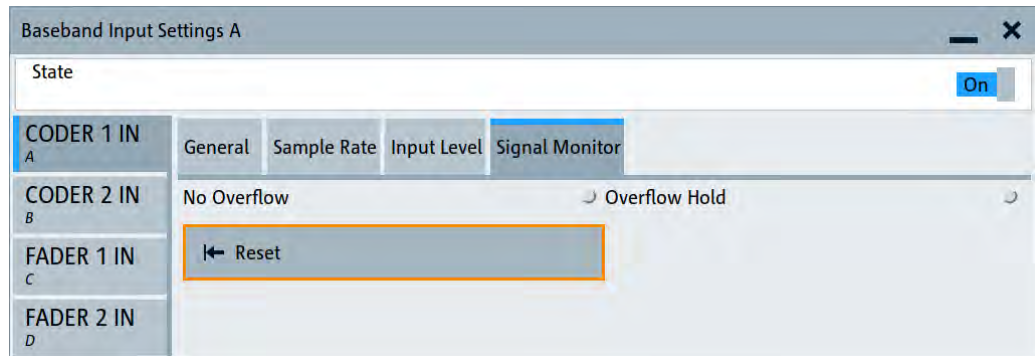
**Settings:**

[Signal Monitoring](#)..... 158

**Signal Monitoring**

The R&S SMW200A monitors constantly the input signal (crest factor and peak level) and indicates an overflow status, if the selected "Peak Level" (in dB full scale) value does not correspond with the real value.

**Note:** The overflow status is indicated as long as the "Peak Level" value is not corrected.

To avoid overflow effects, enable automatic measurement with the "Auto Level Set" function.

**"Overflow/No Overflow"**

Indicates whether the input is overloaded or not. An additional indication is displayed in the block diagram close to the corresponding connector.

Remote command:

[\[:SOURce<hw>\]:BBIN:OLOad:STATE?](#) on page 1035

**"Overflow Hold"**

Indicates an overload since the last reset for evaluating the measurement.

To reset the state, use one of the following:

- Select "Reset"
- Start a new measurement with the "Auto Level Set" function
- Change the value of one of the monitored parameters.

Remote command:

[\[:SOURce<hw>\]:BBIN:OLOad:HOLD:STATE?](#) on page 1035

**"Reset"**

Resets the "Overload Hold" indication.

Remote command:

[\[:SOURce<hw>\]:BBIN:OLOad:HOLD:STATE?](#) on page 1035

**4.6.2 Baseband input settings in the wideband baseband generator**

Option: R&S SMW-B9

### To access and configure the "Baseband Input" settings

The "BB Input" block provides access to the settings for frequency offset and path gain, and to the available configuration parameters of the external signal.

The digital baseband input interfaces **HS DIG I/Q** are located on the R&S SMW200A rear panel, see [Section 4.3.1, "Physical location of the input and output interfaces"](#), on page 109.

In the default instrument state, the block diagram displays the connector in an unfolded state. The digital input interfaces are inactive (gray LEDs).

1. To display the "BB Input" block, select the symbol "CODER 1"/"CODER 2".

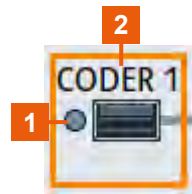
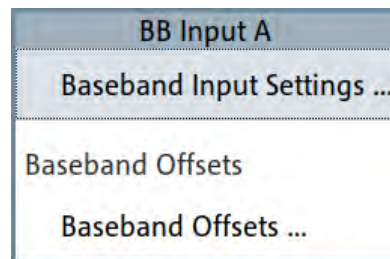

Figure 4-12: Representation of the digital baseband input interface HS DIG I/Q

1 = Digital input interface state: gray = inactive; blue = active  
2 = Connector name

2. To access the dialog box for configuring the external signal input depending on the current "System Configuration" > "Fading/Baseband Config", select "BB Input" > "Baseband Input Settings".



The dialog provides settings necessary to define the used connector, and to configure signal parameters, like the sample rate and the baseband input level.

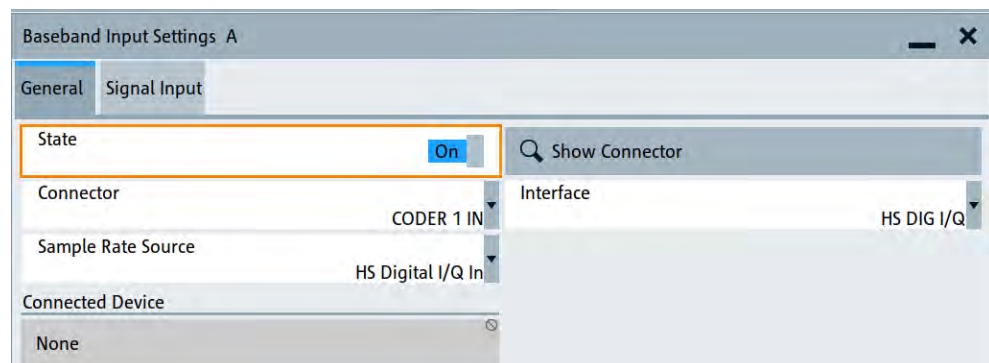

In this dialog, you access the **settings the HS DIG I/Q connector**. You recognize the type of connector that is active by the used **connector icon**.

3. To set the input connector, select "BB Input" > "Interface" > "HS DIG I/Q".
4. To enable the input signal, set "Baseband Input Settings" > "State" > "On".

**Settings:**

- [General settings](#)..... 160
- [Signal input settings](#)..... 162

**4.6.2.1 General settings**

Access:

1. Select "BB Input" > "Digital I/Q In" > "Baseband Input Settings".
2. Select "BB Input" > "Interface" > "HS DIG I/Q"

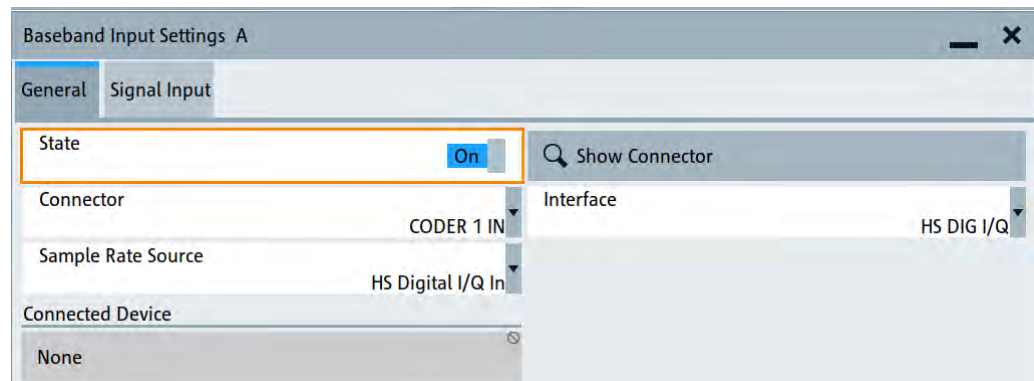
**Settings:**

- [State](#)..... 160
- [Connector](#)..... 160
- [Interface](#)..... 161
- [Sample Rate Source](#)..... 161
- [Connected Device](#)..... 161

**State**

Enables the feeding of the selected external digital signals into the baseband.

Remote command:

[ :SOURce<hw> ] :BBIN:STATe on page 1028

**Connector**

Defines the connector used as an external signal source.

Available are all digital input connectors, as defined with "System Configuration" > "External RF and I/Q" > "Direction" > "Input". See "[Direction](#)" on page 132.

"FADER 1 IN"/"FADER 2 IN"

Option: R&S SMW-B14



Remote command:

[\[:SOURce<hw>\]:BBIN:DIGital:SOURce](#) on page 1028

### Interface

Option: R&S SMW-B9

Sets which of the digital interfaces is used, the DIG I/Q or the HS DIG I/Q.

Remote command:

[\[:SOURce<hw>\]:BBIN:DIGital:INTerface](#) on page 1029

### Sample Rate Source

Selects whether the sample rate is estimated based on the digital input signal or is a manually entered value.

(See also [Section 4.3.5, "Important signal parameters and interface characteristics"](#), on page 114).

"Digital I/Q In"

For CODER connectors:

Estimates the sample rate based on the applied I/Q data clock and displays the resulting value in the value field. The I/Q data clock signal is fed via the DIG I/Q input.

**Note:** Estimation works best if the sample rate is close to the user-defined value.

"HS Digital I/Q In"

Option: R&S SMW-B9

Estimates the sample rate value based on the information transmitted by the transmitter.

Resulting value per channel is displayed by the parameter [Sample Rate](#).

"User Defined" The sample rate is as defined the entry field value.

**Note:** An I/Q data clock is not necessary but the external signal source (typically a second Rohde & Schwarz Instrument). Also, the signal source instrument and the signal sink instrument receiving have to use common external reference signal.

Remote command:

[\[:SOURce<hw>\]:BBIN:SRATe:SOURce](#) on page 1032

### Connected Device

If the connection to the external device is properly established and signal transmission is active, this parameter displays information on the instrument connected to the DIG I/Q interface:

- Name, serial number and port of the connected instrument
- The transmitter sample rate, if supported by the transmitter

"None" indicates that no device is connected.

Remote command:

[\[:SOURce<hw>\]:BBIN:CDEvice?](#) on page 1029

4.6.2.2 Signal input settings

Access:

1. Select "BB Input" > "Digital I/Q In" > "Baseband Input Settings".
2. Select "Interface" > "HS DIG I/Q".
3. Select "Signal Input".

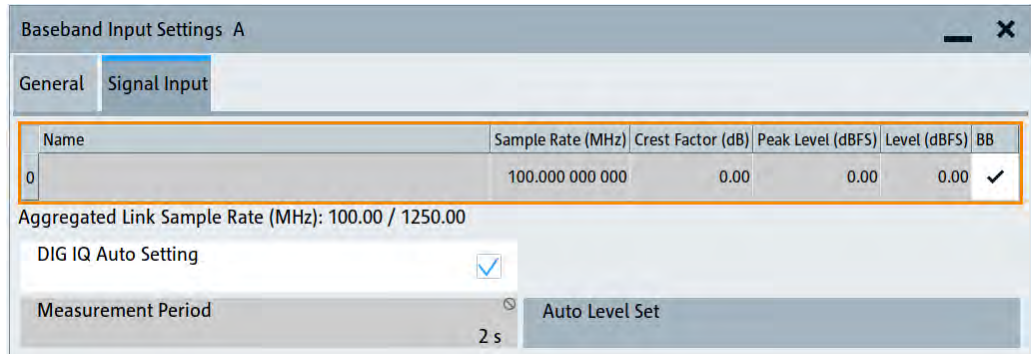

Figure 4-13: Signal Input settings in wideband baseband with separate BB sources

Settings:

Channel Table..... 162

- L Number..... 162
- L Name..... 162
- L Sample Rate..... 163
- L Crest Factor..... 163
- L Peak Level..... 163
- L Level..... 163
- L BB..... 163

Aggregated Link Sample Rate..... 163

DIG IQ Auto Setting..... 163

Measurement Period..... 164

Auto Level Set..... 164

**Channel Table**

Displays information on the up to 8 digital channels per HS DIG I/Q interface:

**Number ← Channel Table**

Subsequent number.

**Name ← Channel Table**

Channel indication, set by the transmitter.

Remote command:

[ :SOURce<hw> ] :BBIN:CHANnel<ch0>:NAME on page 1029

**Sample Rate ← Channel Table**

Displays the used sample rate per channel.

Setting the sample rate requires R&S SMW-K556.

For information on the maximum sample rate and the aggregated link sample rate, see ["Aggregated Link Sample Rate"](#) on page 163.

Remote command:

`[ :SOURce<hw> ] :BBIN:CHANnel<ch0>:SRATe` on page 1031

**Crest Factor ← Channel Table**

If [DIG IQ Auto Setting](#) > "Off", sets the crest factor per channel.

Remote command:

`[ :SOURce<hw> ] :BBIN:CHANnel<ch0>:POWER:CFACtor` on page 1030

**Peak Level ← Channel Table**

If [DIG IQ Auto Setting](#) > "Off", sets the peak level per channel. The value is set as attenuation in digital baseband domain.

Remote command:

`[ :SOURce<hw> ] :BBIN:CHANnel<ch0>:POWER:PEAK` on page 1030

**Level ← Channel Table**

Indicates the level, set automatically depending on the selected peak level and crest factor.

Remote command:

`[ :SOURce<hw> ] :BBIN:CHANnel<ch0>:POWER:RMS` on page 1030

**BB ← Channel Table**

Activates the channel.

You can only activate one channel at a time. Toggle the state of the channel to test all channels one after another.

Remote command:

`[ :SOURce<hw> ] :BBIN:CHANnel<ch0>:BB:STATe` on page 1029

**Aggregated Link Sample Rate**

Indicates the aggregated sample rate and the maximum sample rate, where:

- The aggregated sample rate is the sum of the sample rates of all active channels. It cannot exceed the maximum sample rate.
- The R&S SMW200A supports two standard max. sample rate values. This parameter indicates the currently selected one, where the max. sample rate is selected depending on the capabilities of the transmitter/receiver.

For more information, refer to the specifications document.

Remote command:

`[ :SOURce<hw> ] :BBIN:SRATe:SUM?` on page 1032

`[ :SOURce<hw> ] :BBIN:SRATe:MAX?` on page 1032

**DIG IQ Auto Setting**

Activates an automatic adjustment of the baseband input signal.

The R&S SMW200A receives peak level, level and crest factor values directly from the connected transmitter and recognizes changes automatically.

Remote command:

[\[:SOURCE<hw>\]:BBIN:DIGital:ASETting:STATe](#) on page 1033

#### Measurement Period

For CODER connectors:

Sets the recording duration for measuring the baseband input signal by "Auto Level Set".

**Note:** For accurate level measurements, set the measurement period to a time value that is long enough to capture several periods of the input signal.

Remote command:

[\[:SOURCE<hw>\]:BBIN:MPERiod](#) on page 1033

#### Auto Level Set

For CODER connectors:

Starts measuring the input signal for estimating the crest factor, the peak level, and the Level of the input signal.

See also "[Signal processing prerequisites for external baseband signals](#)" on page 116.

Remote command:

[\[:SOURCE<hw>\]:BBIN:ALEVel:EXECute](#) on page 1034

## 4.7 I/Q digital output settings

### Required Options

The equipment layout for output of digital I/Q signal ([Standard baseband](#)) includes:

- Option standard baseband generator (R&S SMW-B10) per signal path (incl. one digital interface DIG I/Q per installed option) and option standard baseband main module, one/two I/Q paths to RF (R&S SMW-B13/-B13T)
- Up to two options digital baseband output (R&S SMW-K18) per required output
- Up to four options fading simulator (R&S SMW-B14) (incl. one digital interface DIG I/Q per installed option)

The equipment layout for the output of digital I/Q ([Wideband baseband](#)) includes:

- 2 options wideband baseband generator (R&S SMW-B9) (incl. digital interfaces DIG I/Q 1/2 and HS DIG I/Q 1/2 and per installed option)
- Option wideband baseband main module, two I/Q paths to RF (R&S SMW-B13XT)
- Up to four options fading simulator (R&S SMW-B15) (incl. one digital interface DIG I/Q per installed option)
- Up to two options wideband digital baseband outputs R&S SMW-K19

For more information, refer to the specifications document.

### To access and configure the "I/Q Digital Output" settings in "System Configuration > Mode > Standard"

The digital output connectors are located on the R&S SMW200A rear panel, see [Section 4.3.1, "Physical location of the input and output interfaces"](#), on page 109.

In the default instrument state ([Standard mode](#)), the block diagram displays the BBMM connectors in a folded state. The digital output interfaces are inactive (gray LEDs).

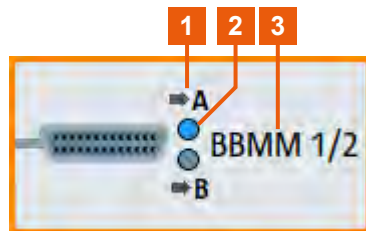

**Figure 4-14: Representation of the digital output interface DIG I/Q in standard mode**

- 1 = mapped I/Q stream
- 2 = digital output interface state: gray = inactive; blue = active
- 3 = digital output connector name

1. Select the "BBMM 1/2" symbol to unfold the "I/Q Digital" block.
2. In [Wideband baseband](#) instrument, you access the settings of both, the DIG I/Q and the HS DIG I/Q connectors in the same manner. You recognize the type of connector that is active by the used connector icon.  
To change the output connector, select "System Config > Signal Outputs" = **"Analog & Digital (HS) or Digital Only (HS)"**.
3. To route or reroute the I/Q streams to the digital outputs, select the "I/Q Stream Mapper" block.
4. To enable the baseband signal at the digital outputs, select "Block Diagram > I/Q Digital A or B > I/Q Digital > On".
5. To access the dialog box for configuring the digital output signal, select "I/Q Digital > I/Q Digital Outputs".

### To access and configure the "I/Q Digital Output" settings in "System Configuration > Mode > Advanced"

The digital output connectors are located on the R&S SMW200A rear panel, see [Figure 4-1](#).

In [Advanced mode](#), the block diagram displays all digital output interfaces as one common connector symbol in folded state. The digital output interfaces are inactive (gray LED).

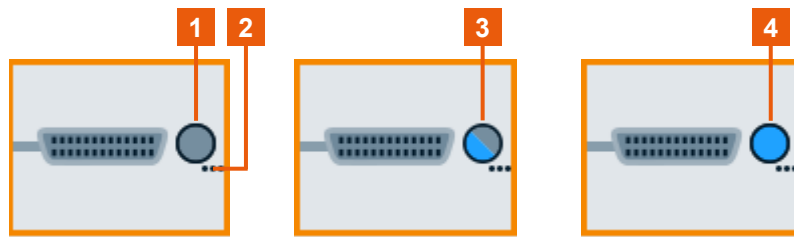

Figure 4-15: Folded view of digital output interface DIG I/Q in advanced mode

- 1 = digital output interface state: grey = all inactive
- 2 = more settings indication; select to unfold detailed information
- 3 = digital output interface state: half grey/blue = one interface active and one interface inactive
- 4 = digital output interface state: blue = all active

1. Select the connector icon to unfold the settings.

The unfolded view displays more information on mapped streams and configured connectors.

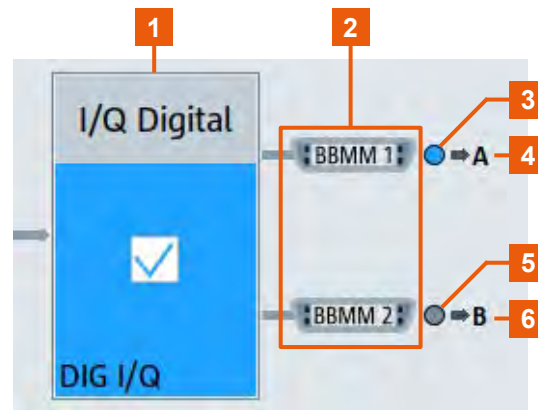

Figure 4-16: Unfolded view of digital output interface DIG I/Q in advanced mode

- 1 = I/Q digital output state: gray = inactive; blue = active
- 2 = digital connector name
- 3, 5 = digital output interface state: gray = inactive; blue = active
- 4, 6 = mapped I/Q streams

The indication and access to the settings of the HS DIG I/Q interfaces follow the same principle. Merely the connector indication changes.

**Note:** The number of the displayed digital output interfaces corresponds to the number of enabled [Streams \(Rx Antennas\)](#) in the "System Configuration > Fading/Baseband Configuration" dialog.

2. To route or reroute the I/Q streams to the digital outputs, select the "I/Q Stream Mapper" block.
3. To enable the baseband signal at the digital outputs, select "Block Diagram > I/Q Digital > I/Q Digital > On".
4. To access the dialog box for configuring the digital output signal, select "I/Q Digital > I/Q Digital Outputs".

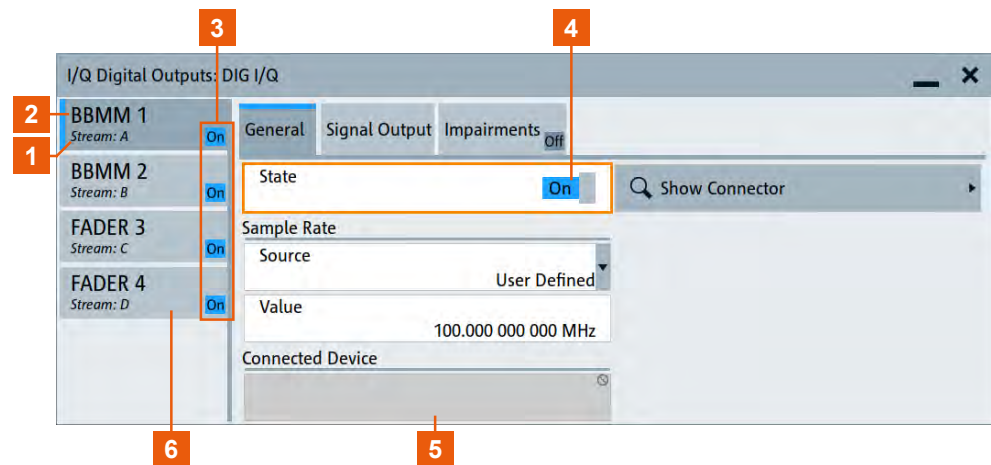

**Figure 4-17: I/Q digital outputs: Understanding the displayed information (standard baseband)**

- 1 = Mapped I/Q streams
- 2 = Digital output interface name
- 3, 4 = State of the I/Q digital output interface
- 5 = Indicates the connected instrument and digital interface
- 6 = Side tabs: one tab per digital output

Using the "I/Q Stream Mapper" you defined which stream is routed to which output connector. The settings provided in the "I/Q Digital Outputs" dialog enable you to define how each stream is output at the digital output interface, for example digitally impaired or not.

If an R&S SGT is connected to the DIG I/Q digital interface, digital impairments like for example intended I/Q delays are applied in the connected instrument.

Refer to [Section 6.4, "Impairing the signal"](#), on page 449 for description of the impairments functionality.

In **Advanced mode**, the dialog consists of more than one tabs on the side, whereas the number of tabs corresponds to the number of available digital output interfaces. The tab name displays the output interface the settings are related to and an overview information on the streams mapped to the particular connector.

5. To configure the connected external instruments, use the "System Config > System Configuration > External RF and I/Q" dialog.

### 4.7.1 General settings

Access:

- ▶ Select "I/Q Digital" > "I/Q Digital Outputs".

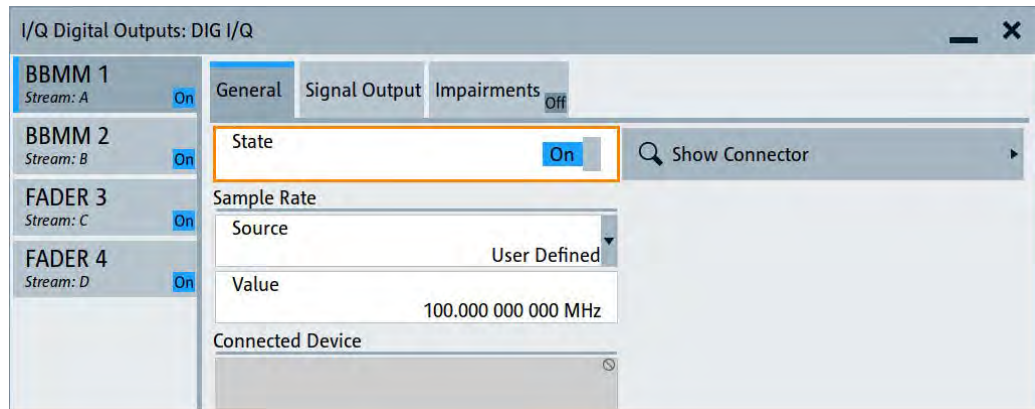

If an R&S SGT is connected to the DIG I/Q interface of the R&S SMW200A, several parameters set automatically.

### Settings:

State.....	168
Show Connector.....	168
Sample Rate.....	168
L Slow IQ State.....	168
L Common to all Channels.....	169
L Source.....	169
L Value.....	169
Connected Device.....	169

### State

Enables the digital I/Q output.

Remote command:

`[ :SOURce ] : IQ : OUTPut : DIGital : BBMM <ch> : STATE` on page 1219

`[ :SOURce ] : IQ : OUTPut : DIGital : FADer <ch> : STATE` on page 1219



### Show Connector

Accesses a dialog that displays the physical location of the selected connector on the front/rear panel of the instrument.

A blinking LED on the front/rear panel indicates the selected connector, too (see [Section 12.2.2.4, "Status indicators"](#), on page 746).

### Sample Rate

Comprises the sample rate parameters:

#### Slow IQ State ← Sample Rate

Option: R&S SMW-K551

If "Digital Only" or "Digital Only Multiplexed" signals are generated, this parameter shows whether a "Sample Clock Request" is enabled in the connected R&S EX-IQ-Box.



All digital outputs must work in the same mode, that is with "Slow IQ = On" or "Slow IQ = Off". You can change the state of any one of the outputs; the state of the other is set automatically.

Remote command:

`[ :SOURce ] :IQ:OUTPut:DIGital:BBMM<ch>:SLOW:STATe` on page 1220

#### Common to all Channels ← Sample Rate

Option: R&S SMW-B9/-K19

If enabled, the same sample rate value is applied to all channels, see [Section 4.7.2, "Channels settings"](#), on page 170.

#### Source ← Sample Rate

For DIG I/Q interfaces, selects whether the sample rate is estimated based on the digital signal or a manually entered value.

"User Defined" Enables you to define the sample rate in the entry field value. An I/Q data clock is not necessary.

"Digital I/Q Out"

Option: R&S SMW-B10

Estimates the sample rate based on the applied I/Q data clock and displays the resulting value in the "Value" field.

Remote command:

`[ :SOURce ] :IQ:OUTPut:DIGital:BBMM<ch>:SRATe:SOURce` on page 1220

`[ :SOURce ] :IQ:OUTPut:DIGital:FADer<ch>:SRATe:SOURce` on page 1220

#### Value ← Sample Rate

Sets/displays the sample rate of the digital I/Q output signal. The maximal sample rate depends on the connected receiving device.

If "Common to all Channels > On" is used, the same all digital channels are sampled with the same rate.

Remote command:

`[ :SOURce ] :IQ:OUTPut:DIGital:BBMM<ch>:SRATe` on page 1221

`[ :SOURce ] :IQ:OUTPut:DIGital:FADer<ch>:SRATe` on page 1221

#### Connected Device

If the connection to the external device is properly established and signal transmission is active, this parameter displays information on the instrument connected to the DIG I/Q interface:

- Name, serial number and port of the connected instrument
- The transmitter sample rate, if supported by the transmitter

"None" indicates that no device is connected.

Remote command:

`[ :SOURce ] :IQ:OUTPut:DIGital:BBMM<ch>:CDEvice?` on page 1222

`[ :SOURce ] :IQ:OUTPut:DIGital:FADer<ch>:CDEvice?` on page 1222

## 4.7.2 Channels settings

Option: R&S SMW-B9/-K19

Access:

1. Select "System Config" > "Fading/Baseband Config".
2. Select "Signal Outputs" > "Digital Only (HS)".
3. Set the number of channels per HS DIG I/Q interface, where the total number of channels on all interfaces cannot exceed eight.  
For example, for "HS Channels per > BBMM1", set "Channels" = "4".
4. Select "I/Q Digital > I/Q Digital Settings > Channels".

Name	Stream	Sample Rate (MHz)	Peak Level (dBFS)	Level (dBFS)	Active	
0	BBMM1_CH0	A	250.000 000 000	0.00	0.00	✓
1	BBMM1_CH1	B	250.000 000 000	0.00	0.00	
2	BBMM1_CH2	C	250.000 000 000	0.00	0.00	✓
3	BBMM1_CH3	D	250.000 000 000	0.00	0.00	✓

Aggregated Link Sample Rate (MHz): 750.00 / 1250.00

The dialog consists of two tabs on the side, of per digital output interface HS DIG I/Q. The tab name displays the output interface the settings are related to and an overview information on the streams mapped to the particular connector.

The channels are displayed in table form, where the number of rows corresponds to the number of channels per interface as set with the parameter **HS Channels per BBMMx**.

### Number

Subsequent number.

### Name

Sets the name of the channel of the used interface.

The default channels naming syntax is <interface name>\_CH<channel number> but you can change it if necessary.

Remote command:

`[ :SOURce ] :IQ:OUTPut:DIGital:BBMM<ch>:CHANnel<st0>:NAME` on page 1225

### Stream

Indicates the streams that are routed to the channel.

To change the routing, use the "I/Q Stream Mapper".

**Sample Rate**

Sets the sample rate per channel.

- If [Common to all Channels](#) > "Off", you can set the sample rate per channel individually.
- If [Common to all Channels](#) > "On", the value resembles the value set with the parameter [Value](#).

For information on the max. sample rate and the aggregated sample rate, depending on the number of active channels, observe the indication [Aggregated Link Sample Rate](#).

**Tip:** For tests at max. sample rate, set the sample rate per channel to the max. value and activate the channels one by one subsequently.

See also [Section 4.3.4, "Supported digital interfaces and system configuration"](#), on page 113.

Remote command:

```
[ :SOURce ] : IQ : OUTPut : DIGital : BBMM < ch > : CHANnel < st0 > : SRATe
on page 1226
```

**Peak Level**

Setting this parameter requires "Set Level Via > Peak Level".

Sets the peak level of the output signal relative to full scale of 0.5 V (in terms of dB full scale).

Option: R&S SMW-B9/-K19

Parameter is read-only in the configuration "Mode > Advanced" and "Signal Outputs > Analog&Digital".

Remote command:

For the output signal at the DIG I/Q interfaces:

```
[ :SOURce ] : IQ : OUTPut : DIGital : BBMM < ch > : POWer : PEP on page 1222
```

```
[ :SOURce ] : IQ : OUTPut : DIGital : FADer < ch > : POWer : PEP on page 1222
```

For the output signal of a channel of the HS DIG I/Q interfaces:

```
[ :SOURce ] : IQ : OUTPut : DIGital : BBMM < ch > : CHANnel < st0 > : POWer : PEP
on page 1222
```

**Level**

Setting this parameter requires "Set Level Via > Level".

Sets the RMS level of the output signal relative to full scale of 0.5 V (in terms of dB full scale).

Parameter is read-only in the following configurations:

- Option: R&S SMW-B10/-K18  
"Signal Outputs > Digital Only Multiplexed"
- Option: R&S SMW-B9/-K19  
"Mode > Advanced" and "Signal Outputs > Analog&Digital"

Remote command:

For the output signal at the DIG I/Q interfaces:

```
[ :SOURce ] : IQ : OUTPut : DIGital : BBMM < ch > : POWer : LEVel on page 1223
```

```
[ :SOURce ] : IQ : OUTPut : DIGital : FADer < ch > : POWer : LEVel on page 1223
```

For the output signal of a channel of the HS DIG I/Q interfaces:

`[ :SOURce ] : IQ : OUTPut : DIGital : BBMM <ch> : CHANnel <st0> : POWer : LEVel`  
on page 1223

### Active

Activates the channel.

Remote command:

`[ :SOURce ] : IQ : OUTPut : DIGital : BBMM <ch> : CHANnel <st0> : STATe`  
on page 1227

### Aggregated Link Sample Rate

Indicates the aggregated sample rate and the maximum sample rate, where:

- The aggregated sample rate is the sum of the sample rates of all active channels. It cannot exceed the maximum sample rate.
- The R&S SMW200A supports two standard max. sample rate values. This parameter indicates the currently selected one, where the max. sample rate is selected depending on the capabilities of the transmitter/receiver.

For more information, refer to the specifications document.

Remote command:

`[ :SOURce ] : IQ : OUTPut : DIGital : BBMM <ch> : SRATe : SUM?` on page 1227

`[ :SOURce ] : IQ : OUTPut : DIGital : BBMM <ch> : SRATe : MAX?` on page 1227

## 4.7.3 Signal output settings

Access:

- ▶ Select "I/Q Digital > I/Q Digital Settings > Signal Output".

"User Variation" and "Group Delay Compensation" settings are not available, if:

- R&S SGT is connected to the DIG I/Q interface of the R&S SMW200A
- "Signal Outputs > Digital Only (HS)"

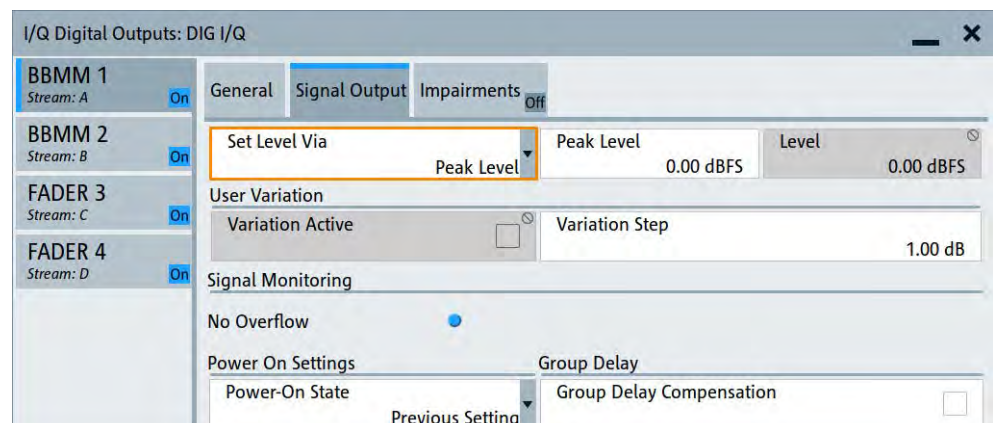

**Settings:**

Signal output level settings.....	173
L Set Level Via.....	173
L Peak Level.....	173
L Level.....	173
User Variation.....	174
Signal Monitoring.....	174
Power-On State.....	175
Group Delay Compensation.....	175

**Signal output level settings**

Comprises the level settings of the digital IQ output signal. The signal level is expressed as a peak or RMS level value.

If R&S SGT is connected to the DIG I/Q interface of the R&S SMW200A, the level parameters are set automatically.

**Note:** The "Level" display always refers to both signal components, i.e.  $SQR(I^2+Q^2)$ .

**Set Level Via ← Signal output level settings**

Selects whether the signal level is expressed as a peak or as RMS level value.

Parameter is read-only in the following configurations:

- Option: R&S SMW-B10/-K18  
"Signal Outputs > Digital Only Multiplexed"
- Option: R&S SMW-B9/-K19  
"Mode > Advanced" and "Signal Outputs > Analog&Digital"

Remote command:

[\[:SOURce\]:IQ:OUTPut:DIGital:BBMM<ch>:POWer:VIA](#) on page 1222

[\[:SOURce\]:IQ:OUTPut:DIGital:FADer<ch>:POWer:VIA](#) on page 1222

**Peak Level ← Signal output level settings**

Setting this parameter requires "Set Level Via > Peak Level".

Sets the peak level of the output signal relative to full scale of 0.5 V (in terms of dB full scale).

Option: R&S SMW-B9/-K19

Parameter is read-only in the configuration "Mode > Advanced" and "Signal Outputs > Analog&Digital".

Remote command:

For the output signal at the DIG I/Q interfaces:

[\[:SOURce\]:IQ:OUTPut:DIGital:BBMM<ch>:POWer:PEP](#) on page 1222

[\[:SOURce\]:IQ:OUTPut:DIGital:FADer<ch>:POWer:PEP](#) on page 1222

For the output signal of a channel of the HS DIG I/Q interfaces:

[\[:SOURce\]:IQ:OUTPut:DIGital:BBMM<ch>:CHANnel<st0>:POWer:PEP](#)  
on page 1222

**Level ← Signal output level settings**

Setting this parameter requires "Set Level Via > Level".

Sets the RMS level of the output signal relative to full scale of 0.5 V (in terms of dB full scale).

Parameter is read-only in the following configurations:

- Option: R&S SMW-B10/-K18  
"Signal Outputs > Digital Only Multiplexed"
- Option: R&S SMW-B9/-K19  
"Mode > Advanced" and "Signal Outputs > Analog&Digital"

Remote command:

For the output signal at the DIG I/Q interfaces:

`[ :SOURce ] : IQ : OUTPut : DIGital : BBMM < ch > : POWer : LEVel` on page 1223

`[ :SOURce ] : IQ : OUTPut : DIGital : FADer < ch > : POWer : LEVel` on page 1223

For the output signal of a channel of the HS DIG I/Q interfaces:

`[ :SOURce ] : IQ : OUTPut : DIGital : BBMM < ch > : CHANnel < st 0 > : POWer : LEVel`  
on page 1223

### User Variation

If the rotary knob is used to adjust the level values, the step width can be defined. The configured step width applies with activated variation.

"User Variation" is disabled, if R&S SGT is connected to the DIG I/Q interface of the R&S SMW200A.

"Variation Active"

Enables the user-defined step width.

Remote command:

`[ :SOURce ] : IQ : OUTPut : DIGital : BBMM < ch > : POWer : STEP :  
MODE` on page 1223

`[ :SOURce ] : IQ : OUTPut : DIGital : FADer < ch > : POWer : STEP :  
MODE` on page 1223

"Variation Step"

Sets the user defined step width.

Remote command:

`[ :SOURce ] : IQ : OUTPut : DIGital : BBMM < ch > : POWer : STEP [ :  
INCRement ]` on page 1224

`[ :SOURce ] : IQ : OUTPut : DIGital : FADer < ch > : POWer : STEP [ :  
INCRement ]` on page 1224

### Signal Monitoring

Option: R&S SMW-B10

If the digital interface is active ("General > State > On"), the R&S SMW200A monitors constantly the output signal and indicates overflow, if the digital signal is clipped. Overload can occur if the level of the output signal, or the noise level (AWGN) are too high.

**"Overflow/No Overflow"**

Indicates whether the I/Q output signal is clipped or not. An additional indication is displayed in the block diagram close to the corresponding connector.

Remote command:

`[ :SOURce ] : IQ : OUTPut : DIGital : BBMM < ch > : OFLow : STATE ?`

on page 1224

`[ :SOURce ] : IQ : OUTPut : DIGital : FADer < ch > : OFLow : STATE ?`

on page 1224

**"Overflow Hold"**

Indicates an overload since last reset for evaluating the measurement.

To reset the state, perform one of the following:

- Select "Reset".
- Start a new signal generation.
- Change the output level.

Remote command:

`[ :SOURce ] : IQ : OUTPut : DIGital : BBMM < ch > : OFLow : HOLD : STATE ?` on page 1225

`[ :SOURce ] : IQ : OUTPut : DIGital : FADer < ch > : OFLow : HOLD : STATE ?` on page 1225

**"Reset"**

Resets the "Overload Hold" indication.

Remote command:

`[ :SOURce ] : IQ : OUTPut : DIGital : BBMM < ch > : OFLow : HOLD : RESet` on page 1224

`[ :SOURce ] : IQ : OUTPut : DIGital : FADer < ch > : OFLow : HOLD : RESet` on page 1224

**Power-On State**

Selects the state which the I/Q digital output connectors DIG I/Q are to resume after the instrument is switched on.

"I/Q Out Off" On power-on, the output is deactivated.

**"Previous Setting"**

Resumes the state that was active before the last switch off.

Remote command:

`[ :SOURce ] : IQ : OUTPut : DIGital : BBMM < ch > : PON` on page 1220

`[ :SOURce ] : IQ : OUTPut : DIGital : FADer < ch > : PON` on page 1220

**Group Delay Compensation**

(enabled for the BBMM connectors and connected R&S EX-IQ-BOX)

If you evaluate digital signals, enable this parameter so that the instrument compensates the group delay response of the internal digital filters.

Remote command:

`[ :SOURce ] : IQ : OUTPut : DIGital : BBMM < ch > : GDElay : CState` on page 1224

## 4.8 I/Q analog output settings

### Required Options

The equipment layout for output of analog I/Q signal includes:

- Option Standard Baseband Generator (R&S SMW-B10) per signal path and Option Baseband main module, one/two I/Q paths to RF (R&S SMW-B13/-B13T) Incl. output the baseband signal at the single-ended outputs
- Option Differential Analog I/Q Outputs (R&S SMW-K16) per signal path

Or

- Option Wideband Baseband Generator (R&S SMW-B9) per signal path and Option Wideband baseband main module two I/Q paths to RF (R&S SMW-B13XT) Incl. output the baseband signal at the single-ended outputs
- Option Wideband Differential Analog I/Q Outputs (R&S SMW-K17)  
One differential output; differential and single-ended signals cannot be output at the same time.

### Access

The analog output connectors I/Q x are located on the R&S SMW200A rear panel, see [Figure 4-3](#).

The block diagram displays the "I/Q OUT 1/2" connector in a folded state. The analog output connectors are inactive (gray LEDs).

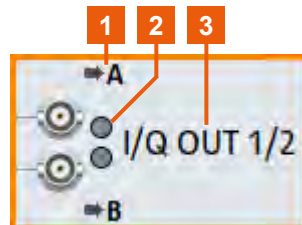

**Figure 4-18: Representation of the analog output interface**

1 = mapped I/Q stream

2 = analog output interface state: gray = inactive; blue = active

3 = analog output connector name

### To access and configure the "I/Q Analog Output" settings

1. Select the "I/Q OUT 1/2" symbol to unfold the "I/Q Analog" block.
2. To (re) route the signal to the analog outputs, select the "I/Q Stream Mapper" block.
3. To enable the baseband signal at the analog outputs, select "Block Diagram > I/Q Analog A or B > I/Q Analog On".
4. To access the dialog box for configuring the analog output signal, select "I/Q Analog > I/Q Analog Settings > General".



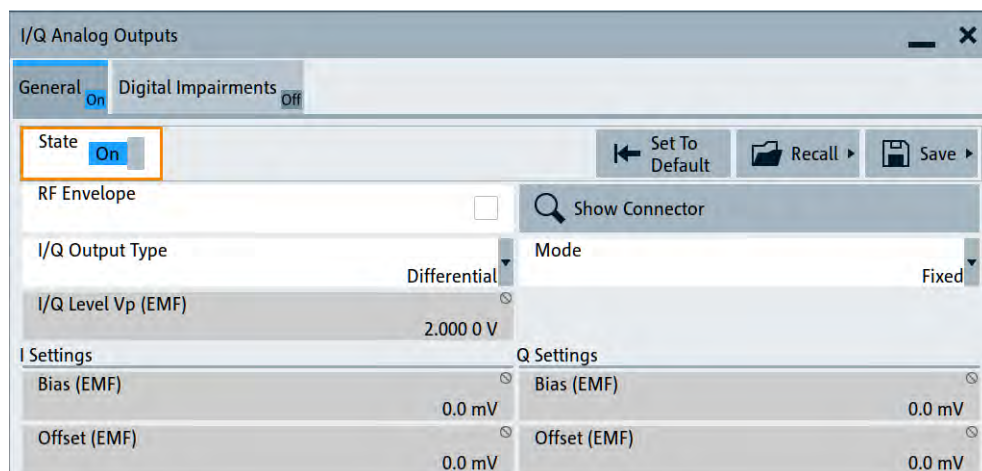

The dialog comprises the settings for selecting the analog output signal type (single-ended or differential), enabling and generating an RF envelope signal, and adding digital impairments to the signal.

- To configure connected external instruments, use the "System Config > System Configuration > External RF and I/Q" dialog.

The parameters defining the voltage level of the output signal are interdependent. Consider the limits listed in ["Maximum overall output voltage"](#) on page 117.

### Maximum overall output voltage

The voltage of the analog output signals is defined as a combination of the output voltage of the I and Q signal components and an optional bias voltage. If you use the differential output, you can also set an offset.

The values of these parameters are interdependent so that the sum of output voltage and bias voltage has an upper limit  $V_{\max}$  as follows:

- Single-ended signal:  $V_p + V_{\text{bias}} \leq 4 \text{ V}$
- Differential signal:  $0.5 \cdot V_p + |V_{\text{bias}}| + 0.5 \cdot V_{\text{offset}} \leq 4 \text{ V}$

Where:

- $V_p$  is the output voltage, see ["I/Q Level Vp \(EMF\)"](#) on page 180.
- $V_{\text{bias}}$  is the bias voltage, see ["Bias \(EMF\)"](#) on page 181.
- $V_{\text{offset}}$  is the offset between inverting and non-inverting output, see ["Offset \(EMF\)"](#) on page 181.

For more information, refer to the specifications document.

### Related settings

- See [Section 4.8.1, "General analog I/Q output settings"](#), on page 178
- See [Section 6.4, "Impairing the signal"](#), on page 449.

See the user manual R&S SMW-K540, R&S SMW-K541 Envelope Tracking and AM/AM, AM/PM Predistortion.

### 4.8.1 General analog I/Q output settings

Access:

- ▶ Select "I/Q Analog" > "I/Q Analog Outputs" > "General".

For impairments settings, see [Section 6.4, "Impairing the signal"](#), on page 449.

#### Settings:

State.....	178
Set To Default.....	178
Save/Recall.....	179
RF Envelope.....	179
Show Connector.....	179
I/Q Output Type.....	179
Mode.....	180
I/Q Level Vp (EMF).....	180
Couple I/Q Bias.....	180
Bias (EMF).....	181
Offset (EMF).....	181

#### State

Enables the analog I/Q signal output at the "I/Q" or "I/Q Bar" connectors. By default, these output connectors are disabled.

Remote command:

[ :SOURce<hw> ] : IQ:OUTPut : ANALog : STATe on page 1213

#### Set To Default

Calls the default settings. The values of the main parameters are listed in the following table.

Parameter	Value
"State"	Not affected by a preset
"RF Envelope"	Off
"I/Q Output Type"	Single Ended Not affected by a preset, if you have connected external instruments and "Pre-set behavior: Keep connections to external instruments" > "On".
"I/Q Level Vp (EMF)"	1 V
"Bias (EMF)"	0 mV

Remote command:

[ :SOURce<hw> ] : IQ:OUTPut [ :ANALog ] : PRESet on page 1214

**Save/Recall**

Opens the "Save/Recall" dialog that is the standard instrument function for saving and recalling the complete dialog-related settings in a file. The provided navigation possibilities in the dialog are self-explanatory.

The settings are saved in a file with a predefined extension. You can define the file-name and the directory, in that you want to save the file.

See also [Section 11.4, "Saving and recalling settings"](#), on page 708.

Remote command:

`[ :SOURce<hw> ] :IQ:OUTPut [ :ANALog ] :SETTing:CATalog?` on page 1214

`[ :SOURce<hw> ] :IQ:OUTPut [ :ANALog ] :SETTing:STORe` on page 1214

`[ :SOURce<hw> ] :IQ:OUTPut [ :ANALog ] :SETTing:LOAD` on page 1214

`[ :SOURce<hw> ] :IQ:OUTPut [ :ANALog ] :SETTing:DELete` on page 1215

**RF Envelope**

Requires R&S SMW-K540.

Enables the output of a control signal that follows the RF envelope. This control signal is provided for power amplifiers envelope tracking testing. The signal is output at the I/Bar connectors.

The envelope tracking (ET) is a method used by modern power amplifiers (PA) to improve their efficiency, especially when amplifying high crest factor RF signals. With envelope tracking, the PA estimates, i.e. "tracks", the RF signal and varies the supply voltage at the end-amplifying stage synchronous to the changes in the RF signal.

See the user manual R&S SMW-K540, R&S SMW-K541 Envelope Tracking and AM/AM, AM/PM Predistortion.

Remote command:

`[ :SOURce<hw> ] :IQ:OUTPut [ :ANALog ] :ENVelope:STATe`

**Show Connector**

Accesses a dialog that displays the physical location of the selected connector on the front/rear panel of the instrument.

A blinking LED on the front/rear panel indicates the selected connector, too (see [Section 12.2.2.4, "Status indicators"](#), on page 746).

**I/Q Output Type**

Selects the type of output signal.

The parameters in the "I/Q Analog Outputs" dialog depend on the selected output mode.

- "Single-Ended"
- If "RF Envelope" > "Off", uses a single-ended output at the I/Q connectors.  
Option: R&S SMW-B9: the signal from "I/Q Analog B" is output at the I Bar connectors.  
See [Figure 4-3](#) and [Figure 4-4](#).
  - If "RF Envelope" > "On", the envelope signal is output at the I connectors.

You can define a bias between the output signal and the ground.

- "Differential" Option: R&S SMW-B10 and R&S SMW-K16  
Or R&S SMW-B9 and R&S SMW-K17.
- If "RF Envelope" > "Off", the analog I/Q signal components are output at the I/Q and I/Q Bar connectors.  
See [Figure 4-3](#) and [Figure 4-4](#).  
Option: R&S SMW-B9: the differential signal output can be activated in "I/Q Analog A" block only. Single-ended and differential signals cannot be output simultaneously.
  - If "RF Envelope" > "On", the inverted envelope signal  $\bar{E}$  is output at the I Bar connectors.

Remote command:

`[ :SOURce<hw> ] :IQ:OUTPut [ :ANALog ] :TYPE` on page 1215

### Mode

Selects fixed mode or variable mode for the power levels at the I/Q outputs.

Option: R&S SMW-B9: both paths use the same mode.

- "Fixed" The power levels of the I/Q signal components are fixed, see table [Table 4-9](#).

**Table 4-9: Fixed mode I/Q output power levels**

"I/Q Output Type"	"I/Q Level Vp (EMF)"	"Bias (EMF)"	"Offset (EMF)"
Single ended	1.0 V	I: 0.0 mV Q: 0.0 mV	-
Differential	2.0 V	I: 0.0 mV Q: 0.0 mV	I: 0.0 mV Q: 0.0 mV

- "Variable" Requires R&S SMW-K16 or R&S SMW-K17.  
Enables individual power level settings of the I/Q signal components.

For more information, refer to the specifications document.

Remote command:

`[ :SOURce<hw> ] :IQ:OUTPut [ :ANALog ] :MODE` on page 1215

### I/Q Level Vp (EMF)

Displays or sets the output voltage for the I and Q signal components. Setting requires "Mode" > "Variable".

To keep the I/Q analog output power levels below the maximum input power level at your DUT, see ["Maximum overall output voltage"](#) on page 117.

Remote command:

`[ :SOURce<hw> ] :IQ:OUTPut :LEVel` on page 1215

### Couple I/Q Bias

Requires "Mode" > "Variable".

If enabled, couples the bias setting of the I signal and the Q signal component. The bias of the I signal component is configurable, the bias of the Q signal component updates automatically to the same value.

For R&S SMW-B9 instruments, coupling is always enabled.

Remote command:

`[ :SOURce<hw> ] :IQ:OUTPut [ :ANALog ] :BIAS:COUPling [ :STATe ]` on page 1216

### Bias (EMF)

Displays or sets the bias DC voltage. This bias is superimposed upon the I or Q signal.

Setting requires "Mode" > "Variable".

For R&S SMW-B9 instruments, both paths use the same bias value.

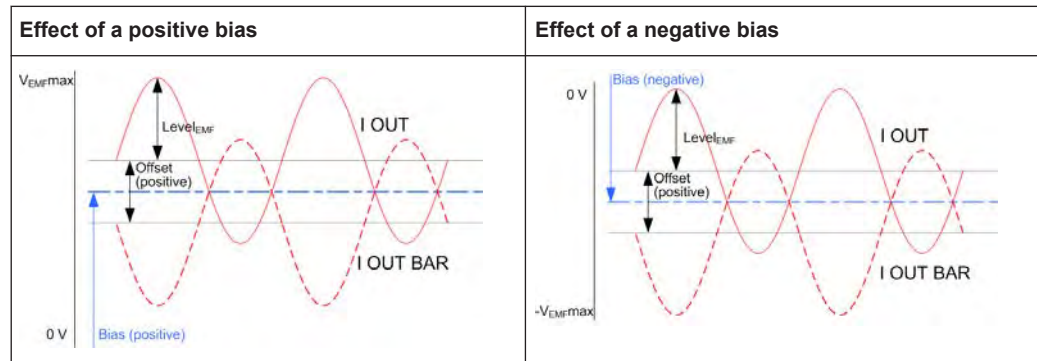

In "Single Ended" mode, this parameter is the bias between the I/Q output signal and the ground. Use this bias, for example, to define the operating point of a DUT.

To keep the I/Q analog output power levels below the maximum input power level at your DUT, see "[Maximum overall output voltage](#)" on page 117.

Remote command:

`[ :SOURce<hw> ] :IQ:OUTPut [ :ANALog ] :BIAS:I` on page 1216

`[ :SOURce<hw> ] :IQ:OUTPut [ :ANALog ] :BIAS:Q` on page 1216

### Offset (EMF)

Requires "I/Q Output Type" > "Differential".

Displays or sets the offset between the inverting and the non-inverting output. Setting requires "Mode" > "Variable".

Sets an offset between the inverting and the non-inverting output.

To keep the I/Q analog output power levels below the maximum input power level at your DUT, see "[Maximum overall output voltage](#)" on page 117.

The selected offset is set half in the positive and half in the negative direction.

How to connect external instruments and configure the signal flow

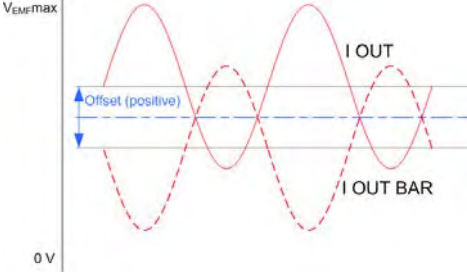
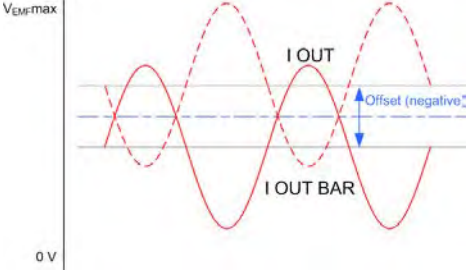
Effect of a positive offset	Effect of a negative offset
	
<p>A positive offset is set with half of the value in the positive direction at the non-inverting outputs, in the negative direction at the inverting outputs.</p>	<p>A negative offset is set with half of the value in the negative direction at the non-inverting outputs, in the positive direction at the inverting outputs.</p>

#### Example: Effect of a positive offset on the I signal component

"I Offset" = 100.0 mV

The offsets applied on the two output connectors are as follows:

- +50.0 mV at the positive signal output
- -50.0 mV at the inverted signal output

Remote command:

`[ :SOURce<hw> ] :IQ:OUTPut [ :ANALog ] :OFFSet:I` on page 1217

`[ :SOURce<hw> ] :IQ:OUTPut [ :ANALog ] :OFFSet:Q` on page 1217

## 4.9 How to connect external instruments and configure the signal flow

This section gives examples on the following topics:

- How to select the required system configuration and to configure the signal flow through the instrument
- How to connect external instruments to the R&S SMW200A and how to configure them
- How to define the input and output signals.

### General workflow

The general workflow described in "[General workflow](#)" on page 101. The [Figure 4-19](#) is a graphical representation of this workflow.

The graphic depicts the main phases for connecting and configuring the R&S SMW200A and the external instruments. This illustration is a simplified diagram that *highlights* the configuration stages performed in the "System Configuration" dialog.

For relevant information on the configuration of the baseband source signal or using the fading simulator and the AWGN generator, see:

- [Section 5, "Configuring the internal baseband source"](#), on page 215

How to connect external instruments and configure the signal flow

- [Section 4.6, "Digital baseband input settings"](#), on page 151
- user manual "Fading Simulator"

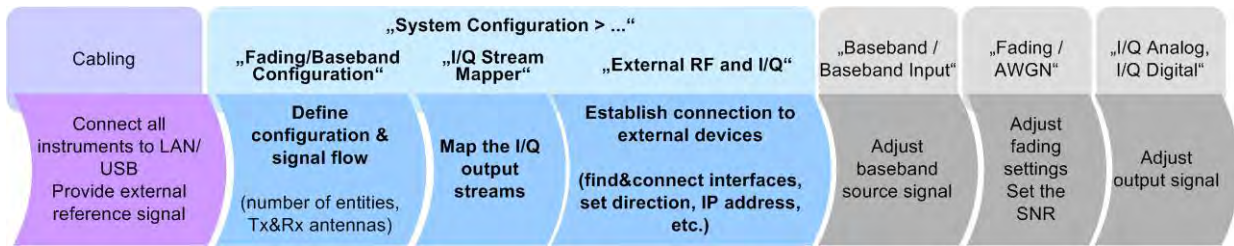

**Figure 4-19: General configuration stages and the steps performed in the System Configuration dialog**

The illustration depicts the steps in general and is intended to explain the configuration in principle.

For a step-by-step description of how to perform the different steps, see:

- [Finding out the suitable configuration for your test situation](#)..... 183
- [How to find out where the input/output interface is located](#)..... 184
- [How to define the MIMO scenario](#)..... 185
- [How to route the I/Q streams to the output interfaces](#)..... 187
- [How to cable the instruments in MIMO test setups](#)..... 188
- [How to connect and configure external instruments](#)..... 189
- [Connecting to HS DIG I/Q interfaces](#)..... 197
- [How to generate a 2x8 MIMO signal for BS tests](#)..... 203
- [How to generate a 8x8 MIMO signal with two R&S SMW200A](#)..... 204
- [How to connect an R&S®CMW500 for fading applications](#)..... 208
- [How to apply an external digital baseband signal](#)..... 210
- [How to connect an R&S EX-IQ-BOX](#)..... 212

#### 4.9.1 Finding out the suitable configuration for your test situation

For conceptual information on the workflow, refer to "[General workflow](#)" on page 101.

1. Select a system configuration form the test cases listed in [Table 4-1](#).  
The table provides a cross-reference between a test scenario and the required configuration.
2. Select "Taskbar > System Configuration > Fading/Baseband Settings":
  - Follow the instructions in "[To simulate complex MxN MIMO scenarios](#)" on page 185.
  - Observe the preview diagram in the "Fading/Baseband Settings" dialog.

This diagram provides a short description and an example of the common application or test scenario of the selected configuration.

For description of the further steps, see:

- [Section 4.9.3, "How to define the MIMO scenario"](#), on page 185

How to connect external instruments and configure the signal flow

- [Section 4.9.4, "How to route the I/Q streams to the output interfaces"](#), on page 187

See also:

- [Section 4.9.5, "How to cable the instruments in MIMO test setups"](#), on page 188
- [Section 4.9.6, "How to connect and configure external instruments"](#), on page 189

## 4.9.2 How to find out where the input/output interface is located

See:

- ["To find out the correct connector"](#) on page 184
- ["To find out the connector's direction"](#) on page 184

### To find out the correct connector

1. Select "Taskbar > System Configuration > External RF and I/Q".
2. In the overview table, navigate to the connector to that you want to connect an external instrument (e.g. "BBMM 1").
3. Select "External Instruments" > "Config".
4. In the "External Instrument Configuration" dialog, select "Show Connector".

A blinking LED on the rear of the instrument indicates the position of the connector.

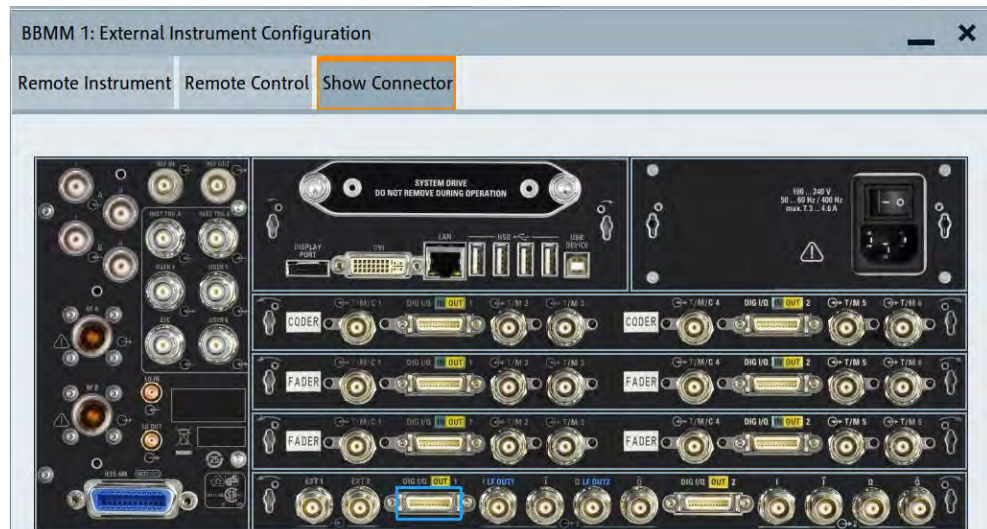

**Tip:** Cross-check whether this digital interface is defined as input or output, before you connect the external instrument.

### To find out the connector's direction

The directions of the digital interfaces at the FADER boards are configurable parameter. Depending on the test setup, each of these connectors can serve as an input or an output connector but not at the same time.



To find out the currently selected connector's direction and the currently defined connectors, proceed as follows:

1. Select "Taskbar > System Configuration > External RF and I/Q".
2. In the overview table, navigate to the required connector.  
Observe the value of the parameter "Direction".

### 4.9.3 How to define the MIMO scenario

See:

- ["To simulate complex MxN MIMO scenarios"](#) on page 185
- ["To define the baseband signal"](#) on page 186

#### To simulate complex MxN MIMO scenarios

The configuration of complex MIMO scenarios undergoes the same steps. We use the configuration of a 1x4x4 MIMO scenario with coupled sources as example to explain the principle.

See also [Section 4.9.1, "Finding out the suitable configuration for your test situation"](#), on page 183.

Proceed as follows:

1. To access the "Fading/Baseband Configuration" settings, use one of the following:
  - Select "Taskbar > System Config > System Configuration"
  - Select "Block Diagram > I/Q Stream Mapper > System Configuration > Fading/Baseband Configuration"
  - Select "Block Diagram > Fading > MIMO > System Configuration".

The "Fading/Baseband Configuration" settings are divided into two modes, the standard mode for more simple non-MIMO configurations and the advanced mode for complex MxN MIMO setups.

2. In the "Fading/Baseband Configuration" tab, enable "Mode > Advanced".  
Set the required configuration.
  - a) Define the number of "Entities"
  - b) Define the number of "BB Signals (Tx Antennas)" and "Streams (Rx Antennas)"

**Tip:** Use the provided preview diagram and description to simplify the decision process.

3. If necessary, adjust the "Baseband Source Configuration".  
For example, to enable the instrument to calculate the required signals and streams out of one baseband signal source, select "BB Source Config > Coupled Sources"

How to connect external instruments and configure the signal flow

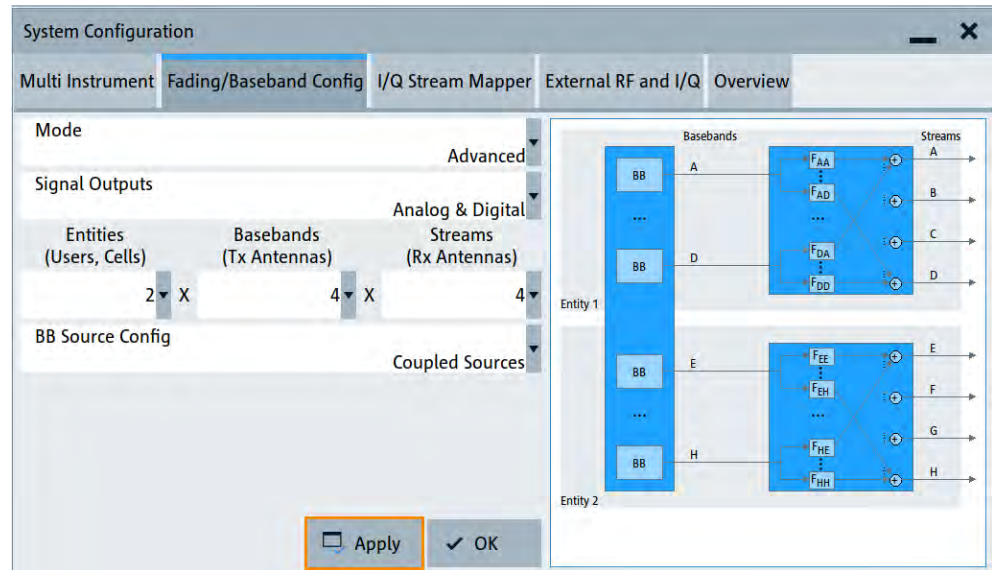

Figure 4-20: Fading/Baseband Config 1x4x4 and coupled baseband sources

- Execute "Apply" to trigger the instrument to adopt the signal routing.  
The block diagram displays the configured signal routing.

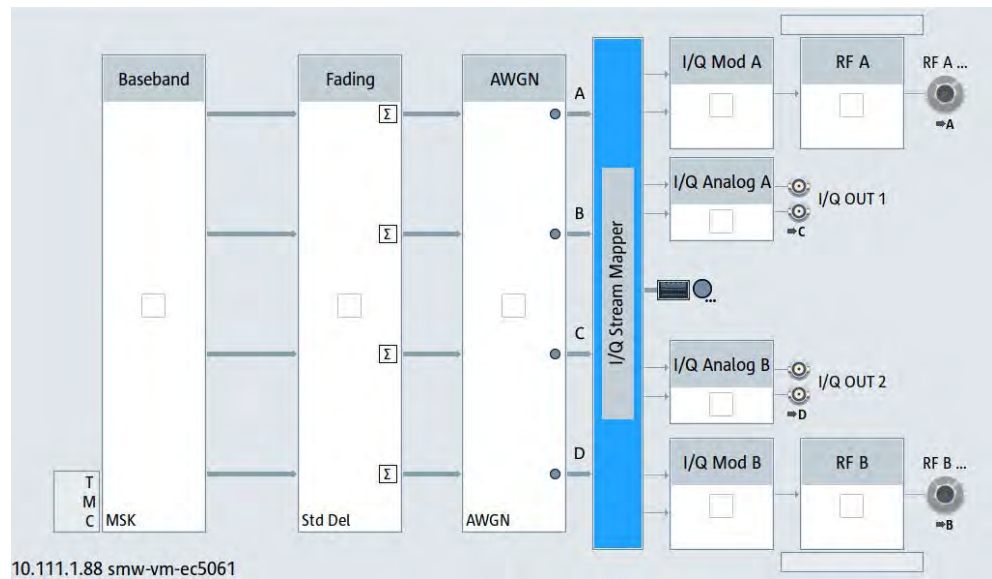

Figure 4-21: Signal routing example (Fading and Baseband Configuration > 1x4x4 and Coupled Baseband Sources)

### To define the baseband signal

To generate an EUTRA/LTE signal, use the following general steps:

- Select "Baseband > EUTRA/LTE".
- Configure the settings as required.  
For example, enable "EUTRA/LTE > Link Direction > Downlink".

How to connect external instruments and configure the signal flow

Select a "DL Test Model > E-TM1.1 5MHz"

3. Select "EUTRA/LTE > State > On" to enable signal generation.
4. In the status bar, select "Frequency A = Frequency B = 2.1432 GHz" and "Lev A = Lev B = -60 dBm".
5. Select "RF A > On" and "RF B > On".

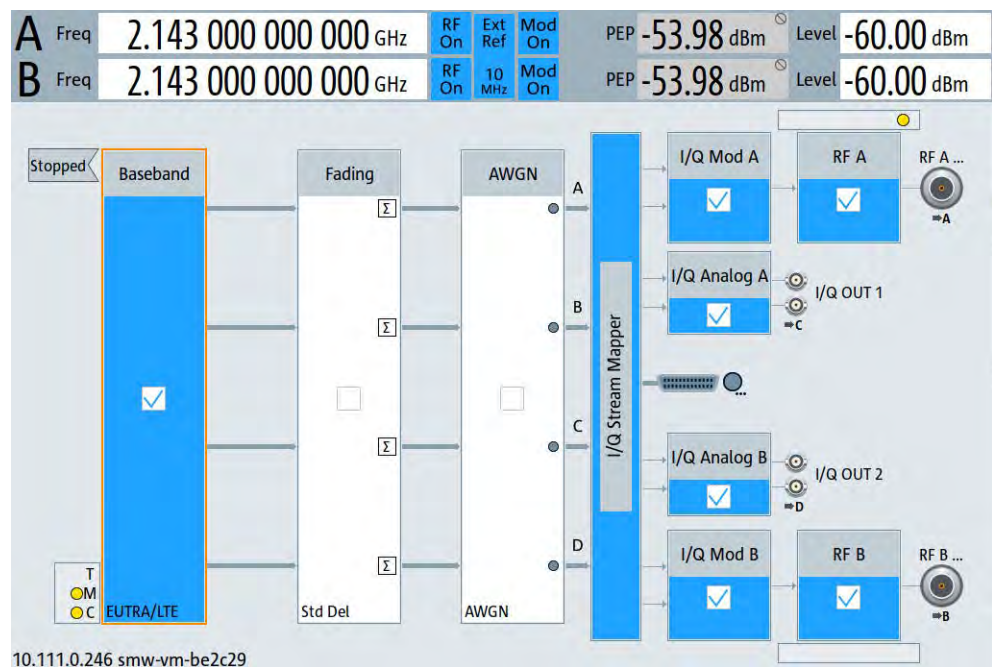

#### 4.9.4 How to route the I/Q streams to the output interfaces

This example shows how to enable the instrument to output the EUTRA/LTE 1x4x4 MIMO signal at both RF outputs and both I/Q analog outputs.

1. Select "Block Diagram > I/Q Stream Mapper".
2. In the I/Q stream mapper matrix, tap on a crossing cell to enable the routing of the selected stream to the corresponding connector.  
For example, enable "Stream A > RF A", "Stream B > RF B", "Stream C > I/Q OUT 1" and "Stream D > I/Q OUT 2".

How to connect external instruments and configure the signal flow

**Tip:** To route more streams to one output connector, in the "I/Q Stream Mapper" dialog and for the particular connector, select "Combination> Add" and select the streams to be routed to it.

	Frequency Offs (Hz)	Phase Offs (°)	RF A	RF B	I/Q OUT 1	I/Q OUT 2	BBMM 1	BBMM 2	FAD 3	FAD 4
Stream A	-20 000 000.00	0.00	✓				✓			
Stream B	0.00	0.00		✓				✓		
Stream C	0.00	0.00			✓		✓		✓	
Stream D	-20 000 000.00	0.00				✓		✓		✓
Combination			Single	Single	Single	Single	Add	Add	Single	Single

#### 4.9.5 How to cable the instruments in MIMO test setups

The MxN MIMO test setups with more than two Rx antennas ( $N > 2$ ) require the signal of at least three antennas. The R&S SMW200A generates the required signal and outputs two of the antennas signals at the RF outputs. The others signals can be routed to the provided analog and digital I/Q connectors and then processed by a connected instrument, like an RF frontend. Several RF frontend instruments can serve as extended RFs for the R&S SMW200A, for example R&S SGS, or R&S SGT.

The [Figure 4-22](#) shows a 1x4x4 MIMO test setup with two R&S SGS connected to the analog I/Q outputs of the R&S SMW200A.

For information on how to connect instruments to the DIG I/Q interfaces, see [Figure 4-24](#).

How to connect external instruments and configure the signal flow

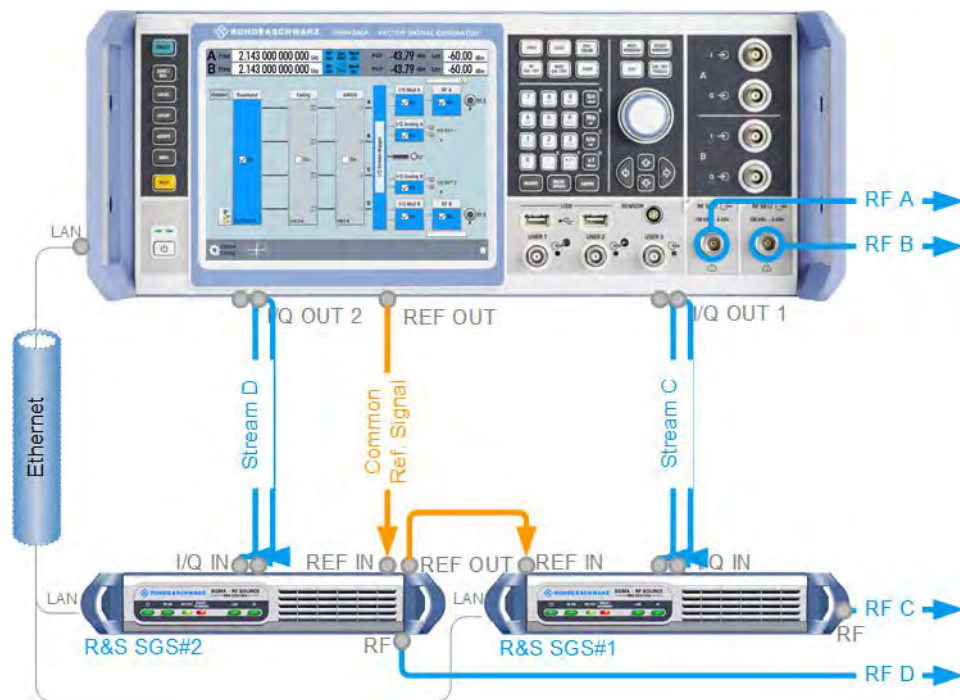

**Figure 4-22: Example of test setup: 1x4x4 MIMO with R&S SMW200A and 2xR&S SGS connected to the I/Q OUT 1/2.**

Blue circle = front panel connector  
 Gray circle = rear panel connector

Refer to "[To connect instruments to the I/Q analog interface](#)" on page 189 for a description of how to configure the R&S SMW200A.

#### 4.9.6 How to connect and configure external instruments

See:

- "[To connect instruments to the I/Q analog interface](#)" on page 189
- "[To connect instruments to the I/Q digital interface](#)" on page 192
- "[To connect and configure an R&S SZU](#)" on page 195
- "[To create a remote control sequence or modify the initialization sequence](#)" on page 194

You have already selected a MIMO scenario and have mapped the I/Q stream to the output interfaces, see:

- "[To simulate complex MxN MIMO scenarios](#)" on page 185
- [Section 4.9.4, "How to route the I/Q streams to the output interfaces"](#), on page 187

##### To connect instruments to the I/Q analog interface

In this example, we assume a "Fading/Baseband Configuration > 1x4x4 MIMO" and the following stream mapping: Stream A and stream B are output at RF A and B; stream C and D at I/Q OUT x respectively.

The test setup uses the analog I/Q outputs and requires two additional instruments, 2xR&S SGS (see [Figure 4-22](#)). To connect and configure each of the R&S SGS to the I/Q output interfaces, proceed as follows:

1. Perform one of the following:
  - Connect the R&S SMW200A and the external instruments to the LAN
  - Connect the external instruments to the USB connector of the R&S SMW200A.
2. Supply all instruments with common frequency reference signal:
  - Use an external common frequency source.
  - Distribute the reference frequency of the R&S SMW200A to the external instruments.

See [Section 8.8, "Reference oscillator"](#), on page 491.

3. Connect the external instruments to the I/Q connectors of the R&S SMW200A with suitable cables.

See also ["To find out the correct connector"](#) on page 184.

4. Select "Block Diagram > I/Q OUT 1/2" to unfold the "I/Q Analog" block

**Note:**

Per default, the analog I/Q outputs are disabled.

5. Select "I/Q Analog > State > On", to enable the analog I/Q outputs with their default settings.
6. Open the "Taskbar > System Config > System Configuration > External RF and I/Q" dialog.  
Select "I/Q OUT1 > External Instrument > Config".
7. In the "I/Q OUT 1: External Instrument Configuration" dialog, select "Detect".

The R&S SMW200A searches through the LAN and the USB connections and updates the dialogs with the retrieved information, like "IP Address", or "Instrument Name".

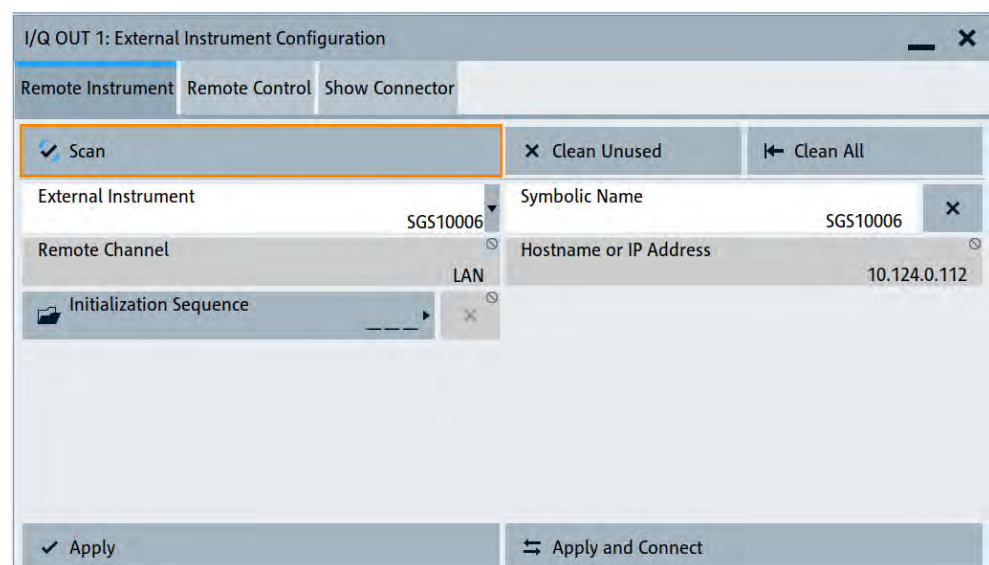

8. Select "Apply".

The "System Config > System Configuration > External RF und I/Q" dialog displays the settings of the connected external instrument.

9. You can disable "RF Couple" state and adjusts the RF settings manually.  
In a MIMO setup however, it is useful to use the coupled settings, because a MIMO setup typically requires the same RF frequency at all antennas.
10. Perform the previous steps to connect and configure the second R&S SGS.
11. Select "I/Q OUT 1 > External Instrument > Config".
  - a) Select "Remote Config > Initialization Sequence".
  - b) Load a file with file extension \*.iec.

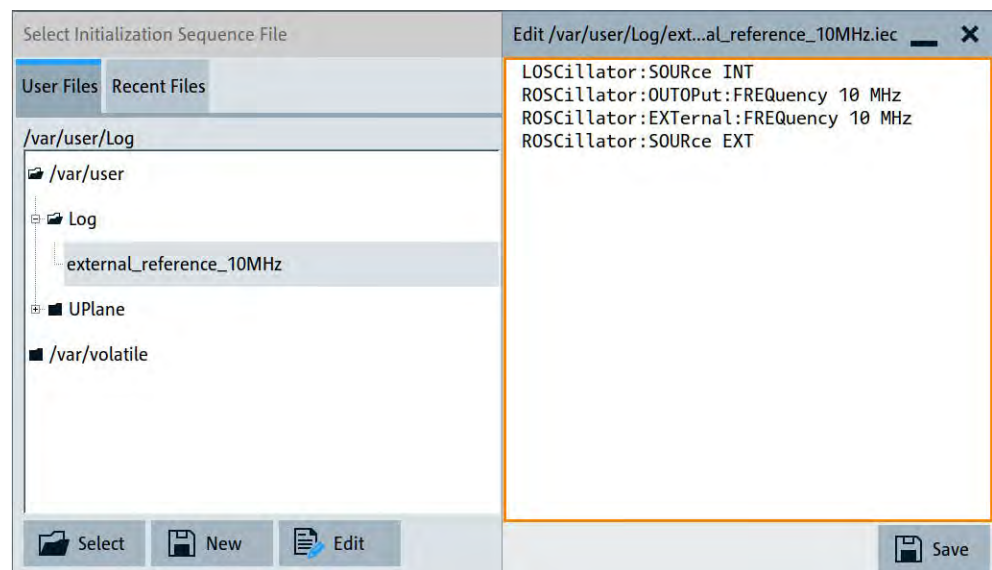

**Tip:** Try out also ["To create a remote control sequence or modify the initialization sequence"](#) on page 194.

12. In the "System Config > System Configuration > External RF und I/Q" dialog, select the "I/Q OUT 1 > Rem Conn" icon to toggle the state.

How to connect external instruments and configure the signal flow

This action establishes the remote connection to the instrument.

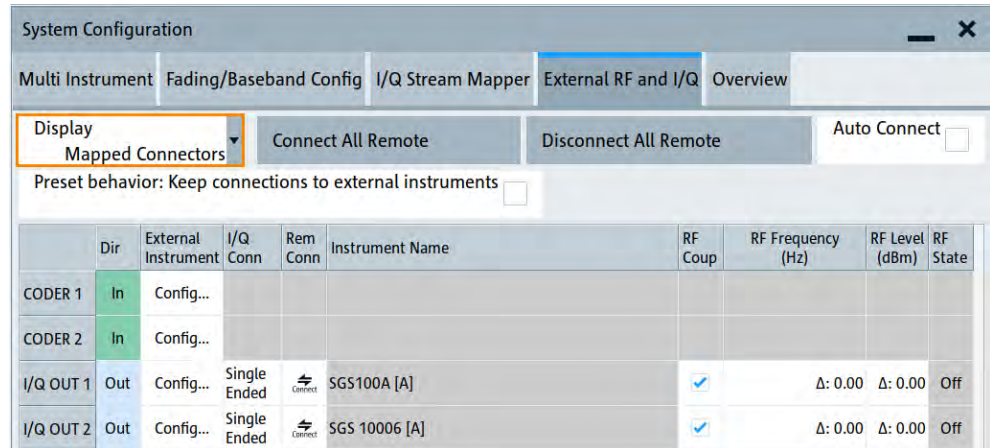

**Figure 4-23: Example: Connecting external instruments to the I/Q OUT 1/2 of the R&S SMW200A (2xR&S SGS)**

The R&S SMW200A:

- Sends a `:DEV: PRES` command to the connected external instrument
- Triggers the external instrument to execute the configuration defined in the initialization sequence file
- Adjusts the RF settings of the external instrument, e.g. applies the same RF frequency at both RF outputs and at the RF outputs of the external instruments.

### To connect instruments to the I/Q digital interface

In this example, we assume a "Fading/Baseband Configuration > 1x4x4 MIMO" scenario and the following stream mapping: Stream A and stream B are output at RF A and B; stream C and D at the BBMM interfaces.

The test setup uses the digital I/Q outputs and requires two additional instruments, for example 2xR&S SGT.

1. Connect two R&S SGT to the BBMM interfaces.  
See [Figure 4-24](#).



How to connect external instruments and configure the signal flow

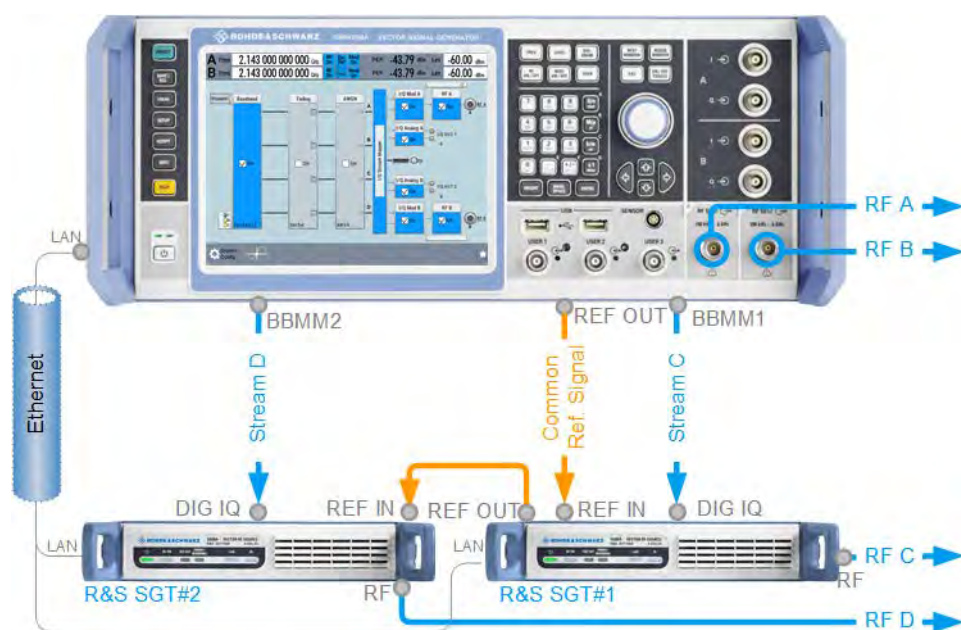

**Figure 4-24:** Example of test setup: 1x4x4 MIMO with R&S SMW200A and 2xR&S SGT connected to the BBMM1/2.

Blue circle = front panel connector  
 Gray circle = rear panel connector

2. Follow the steps described in "To connect instruments to the I/Q analog interface" on page 189.
  - a) In the "System Config > System Configuration > External RF und I/Q", enable "Auto Connect > On".
  - b) Use the example initialization file shown in "To connect instruments to the I/Q analog interface" on page 189.

The "System Configuration > External RF and I/Q" dialog confirms a correct and successful configuration by the active "Rem Conn" status and active "I/Q Conn" status indication.

How to connect external instruments and configure the signal flow

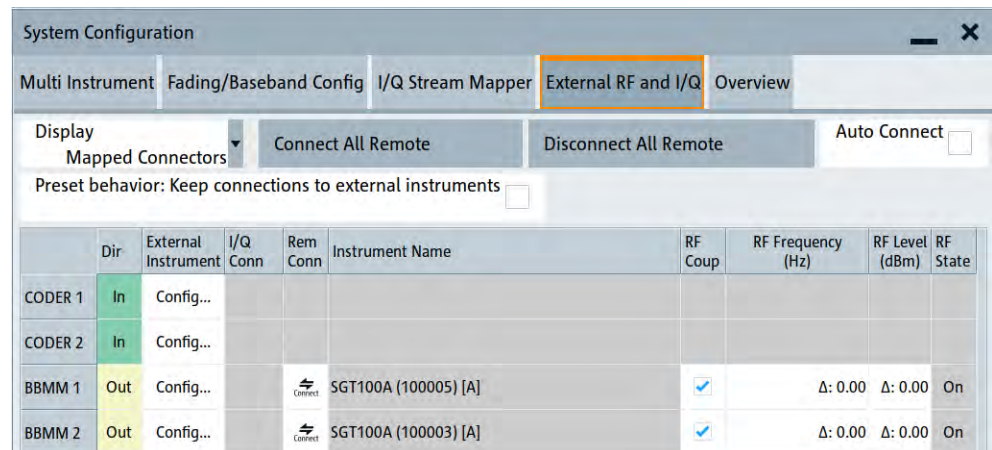

Figure 4-25: Example: Connecting external instruments to the BBMM 1/2 of the R&S SMW200A (2xR&S SGT)

- In the block diagram, select "I/Q Digital".

The dialog confirms the selected configuration. The settings are retrieved and set to fit to the connected R&S SGT.

#### To create a remote control sequence or modify the initialization sequence

You have connected and configured external instruments to the R&S SMW200A as described in ["To connect instruments to the I/Q analog interface"](#) on page 189.

To create a SCPI sequence or your own initialization sequence and send it to an R&S SGS connected to the I/Q interface, proceed as follows:

- On a remote computer, open the notepad or other similar tool.  
Write a sequence of SCPI commands.
- Store the SCPI sequence in a file with file extension `*.iec`.
- Use one of the standard file transfer methods to transfer the file to the user directory `/usb/` of the R&S SMW200A.  
See [Section 11.9, "Transferring files from and to the instrument"](#), on page 725.
- Select "System Config > System Configuration > External RF und I/Q".
- Select "I/Q OUT 1 > External Instrument > Config"
- Select "External Instrument Configuration > Remote Control":
  - Select "Mode > Sequence".
  - Select "File".
  - In the user directory `/usb/`, select the `*.iec` file.
  - Select "Send Sequence".
- Alternatives:
  - Select "External Instrument Configuration > Initialization Sequence".
  - Select "Initialization Sequence".
  - In the user directory `/usb/`, select the `*.iec` file.

See also:

- [Example "Controlling multiple instruments with the same application program"](#) on page 969
- [Example "Connecting an external instrument and sending SCPI commands"](#) on page 971

### To connect and configure an R&S SZU

The following example assumes a differential I/Q connection between the R&S SZU and R&S SMW200A, equipped with wideband baseband generator (R&S SMW-B9). The R&S SZU is connected to RF A.

For more information on the R&S SZU, see the SZU100A Getting Started manual at [www.rohde-schwarz.com/manual/szu100a](http://www.rohde-schwarz.com/manual/szu100a).

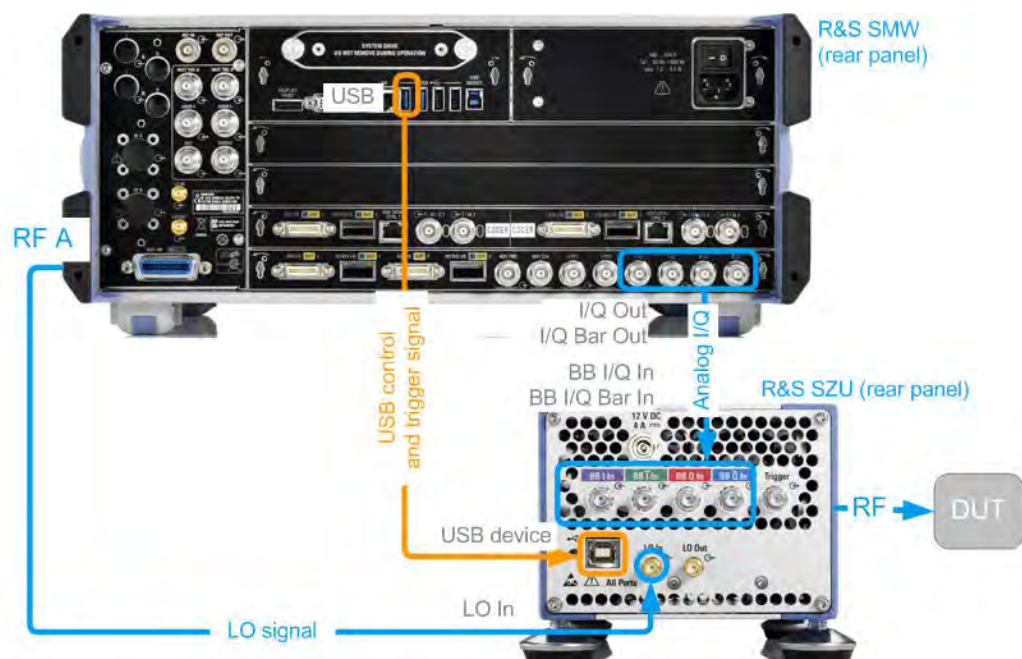

**Figure 4-26: Test setup: 1xR&S SMW200A (R&S SMW-B9) and 1xR&S SZU connected (rear panels)**

RF A	= R&S SMW200A front panel connector
RF	= RF signal at the R&S SZU output (front panel connector)
I/Q, I/Q Bar Out	= Differential analog I/Q outputs
BB I/Q, BB I/Q Bar In	= Differential analog I/Q inputs
USB	= USB control signal for the USB connector of the R&S SMW200A to the USB Device connector of R&S SZU

To connect and configure the R&S SZU to the R&S SMW200A, proceed as follows:

1. Use the cables supplied with the R&S SZU.
2. Connect the R&S SZU to the I/Q and I/Q Bar output connectors of the R&S SMW200A.
3. Connect the RF A output to the LO IN of the R&S SZU.

4. Connect a USB cable to the USB connector and the USB Device connector of R&S SZU.
5. Connect the R&S SZU to the power supply.  
**Note:** Make sure that you keep the warm-up time.
6. At the R&S SMW200A, open the "Taskbar > System Config > System Configuration > External RF und I/Q" dialog.
7. Select "I/Q OUT1 > External Instrument > Config".  
The R&S SMW200A detects the R&S SZU automatically.
8. In the "External Instrument Configuration" dialog, select "External Instrument > SZU (<Serial Number>)".  
Set "I/Q Output Type > Differential".

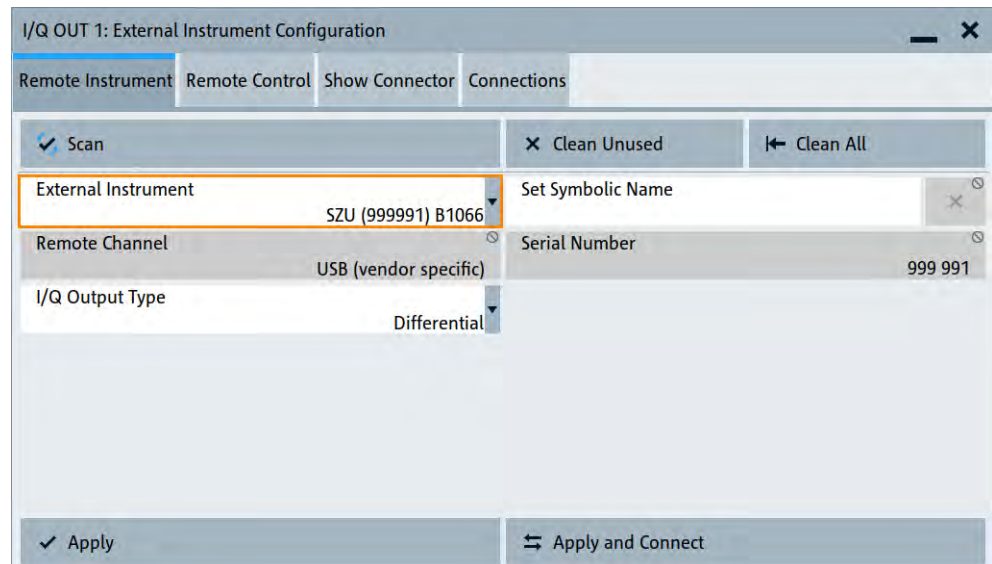

9. Select "Apply".  
The "System Config > System Configuration > External RF und I/Q" dialog displays the settings of the connected external instrument.
10. In the "External RF und I/Q", select "Auto Connect > On".  
Select "Preset behavior: Keep connections to external instruments > On".
11. Open the "External Instrument Configuration > Connections" dialog.  
Select "Check Connections".  
Observe the connection status indications.  
The green color indicates that the required physical connections are in operation.
12. Before connecting the DUT, perform an internal adjustment.
  - a) In the block diagram, select "RF > On".
  - b) Proceed as described in the R&S SZU user manual, chapter "Running internal adjustments".**Note:** You can skip the internal adjustments, if already done.

But if you change the "I/Q Output Type > Differential to Single Ended", or vice versa, the R&S SMW200A issues the following warning message:

"SZU settings conflict: At least one adjustment is done in another mode than the SZU is currently set to (single-ended / differential). Accuracy may be affected!"

13. When internal adjustments finish, select "RF" > "Off".
14. Connect the R&S SZU to the DUT.
15. In the block diagram, select "RF" > "On".

The R&S SMW200A performs the following:

- Retrieves the R&S SZU calibration data.
- Indicates the connected R&S SZU in the block diagram.
- Sets the output signal level and frequency to the default values of the R&S SZU and indicates the value in the status bar.

#### 4.9.7 Connecting to HS DIG I/Q interfaces

In a multi-instrument setup, you can use the R&S SMW200A as a primary instrument and connect secondary instruments to the HS DIG I/Q connectors of the R&S SMW200A. For example, for performance testing, an nx4 MIMO configuration of a 5G NR signal in the frequency band above 6 GHz.

##### To connect to the R&S SMW200A

1. Connect all connections between the R&S SMW200A and the external instruments as in the table below.

**Table 4-10: Signals and connections for R&S SMCV100B as secondary instruments**

Signal	R&S SMW200A	R&S SMCV100B 1	R&S SMCV100B 2
I/Q 1	HS DIG I/Q 1 ("BBMM 1")	Dig. IQ HS 1	-
I/Q 2	HS DIG I/Q 2 ("BBMM 2")	-	Dig. IQ HS 1
Sync/Trigger 1	ADV TRG	User 2	-
Sync/Trigger 2	ADV TRG	-	User 2
Reference 1	REF OUT	Ref In	
Reference 1	-	Ref Out	Ref In
Control	LAN	LAN	LAN

How to connect external instruments and configure the signal flow

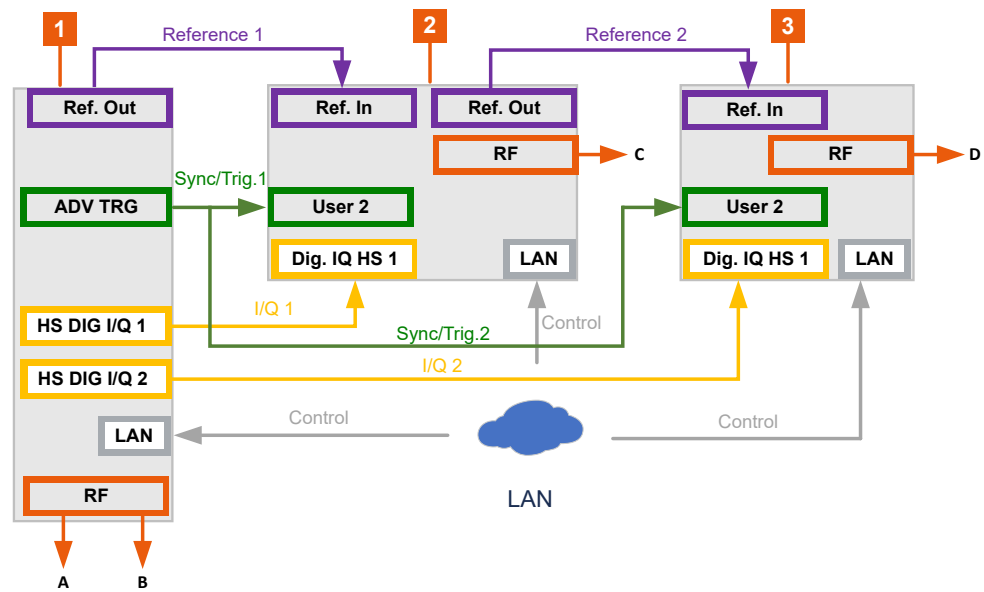

- 1 = R&S SMW200A (primary instrument)
- 2 = R&S SMCV100B 1 (secondary instrument)
- 3 = R&S SMCV100B 2 (secondary instrument)

**Table 4-11: Signals and connections for R&S SMW200A/ R&S SMM100A as secondary instruments**

Signal	R&S SMW200A	R&S SMW200A / R&S SMM100A 1	R&S SMW200A / R&S SMM100A 2
I/Q 1	HS DIG I/Q 1 ("BBMM 1")	HS DIG I/Q 1	-
I/Q 2	HS DIG I/Q 2 ("BBMM 2")	-	HS DIG I/Q 1
Sync/Trigger 1	ADV TRG	ADV CLK	-
Sync/Trigger 2	ADV TRG	-	ADV CLK
Reference 1	REF OUT	REF IN	-
Reference 2	-	REF OUT	REF IN
Control	LAN	LAN	LAN

How to connect external instruments and configure the signal flow

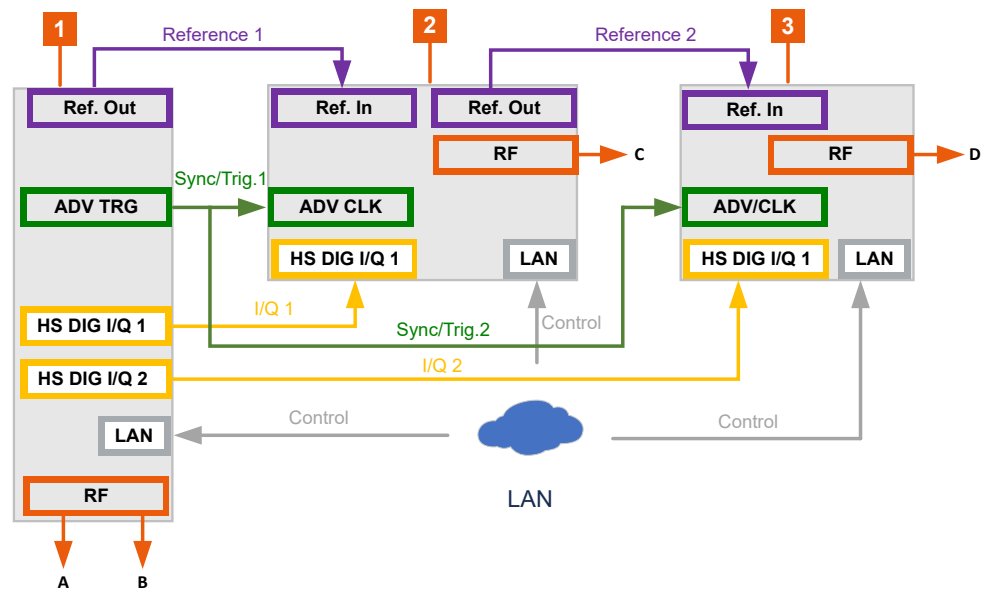

- 1 = R&S SMW200A (primary instrument)  
 2 = R&S SMW200A 1/R&S SMM100A 1 (secondary instrument)  
 3 = R&S SMW200A 2/R&S SMM100A 2 (secondary instrument)

**Note:** Avoid unnecessary cable length and branching points. Use cables of the same length and type for all connections between the primary instrument and the secondary instruments and between secondary instruments.

2. Connect the R&S SMW200A and the external instruments to the same LAN.  
See also ["To find out the correct connector"](#) on page 184.
3. Supply all instruments with a common frequency reference signal:
  - a) On the primary instrument R&S SMW200A, select "RF" > "Reference Frequency" > "Source" > "Internal".  
See [Section 8.8, "Reference oscillator"](#), on page 491.
  - b) On the secondary instruments, select "Reference Frequency" > "Source" > "External".  
For details on how to set the reference frequency of the secondary instrument, see the respective user manual.

#### 4.9.7.1 Configuring the primary instrument

This chapter describes the configuration of the primary instrument exemplary for a setup with R&S SMCV100B as secondary instrument. When using other products as a secondary instrument, the configuration of the primary instrument is analogous.

##### To configure the R&S SMW200A as primary instrument

1. Select "System Config" > "System Configuration" > "Fading/Baseband Config":
  - a) Select "Mode" > "Advanced".
  - b) Select "Signal Outputs" > "Analog & Digital (HS)".

- c) Click "Apply".
2. Select "System Configuration" > "I/Q Stream Mapper".
3. In the "I/Q Stream Mapper" tab, route the I/Q streams to the output connectors:
  - "Stream A": "RF A"
  - "Stream B": "RF B"
  - "Stream C": "BBMM 1"
  - "Stream D": "BBMM 2"
4. Select "System Configuration" > "Multi Instrument".
5. Select "Common Trigger" > "Multi Instrument Trigger" > "Primary".
6. Select "State" > "On".

See also [Section 10.3.1, "Connecting multiple instruments in primary-secondary instrument mode"](#), on page 664 and [Section 10.3.1.1, "Multi-instrument settings"](#), on page 665.

#### To establish a connection to the secondary instrument

1. Select "System Configuration" > "External RF and I/Q".
  - a) Select "BBMM 1" > "External Instrument" > "Config".
  - b) Select "External Instrument" > "SMCV100B".
  - c) If the selection does not list your instrument, click "Scan".  
The scanning procedure checks the interface for connected external instruments.
  - d) Click "Apply and Connect".
  - e) Follow the same procedure for configuring the external instrument on "BBMM 2".
2. Check the status of the remote connection in the "Rem Conn" column.

Multi Instrument										
Fading/Baseband Config			I/Q Stream Mapper			External RF and I/Q		Overview		
Display		Mapped Connectors		Connect All Remote		Disconnect All Remote		Auto Connect <input type="checkbox"/>		
Preset behavior: Keep connections to external instruments <input type="checkbox"/>										
	Dir	External Instrument	I/Q Conn	Rem Conn	Instrument Name	RF Coup	RF Frequency (Hz)	RF Level (dBm)	RF State	
CODER 1	In	Config...								
CODER 2	In	Config...								
BBMM 1	Out	Config...			smcvb	<input checked="" type="checkbox"/>	Δ: 0.00	Δ: 0.00	On	
BBMM 2	Out	Config...								
I/Q OUT 1	Out	Config...	Single Ended							
I/Q OUT 2	Out	Config...	Single Ended							
RF A	Out	Config...								



### To configure the baseband trigger signal

Configure the baseband signal as required for the particular test setup, for example:

1. Select "Baseband" > "5G NR/Sidelink".
2. Configure the trigger signal:
  - a) Select "Trigger In" > "Mode" > "Armed Retrigger".
  - b) Select "Source" > "External Global Trigger 1".
  - c) Enable "Sync. Output To Ext. Trigger".

Synchronization couples the trigger parameters of all basebands. Once you enable baseband signal generation, these baseband signals use a common trigger signal.

### Enabling RF signal generation for all instruments

- ▶ To enable RF signal generation, select "RF" > "On".

Enabling the RF output of the primary instrument R&S SMW200A automatically enables the RF output of the secondary instruments R&S SMCV100B in the setup.

#### 4.9.7.2 Checking the secondary instrument

The primary instrument controls the secondary instruments. It configures the secondary instrument via a remote connection.

The following step-by-step instruction provides an exemplary setup with the R&S SMCV100B as a secondary instrument. For other secondary instrument, the configuration is analogous.

1. Check the block diagram of the secondary instrument after the primary instrument established the remote connection.

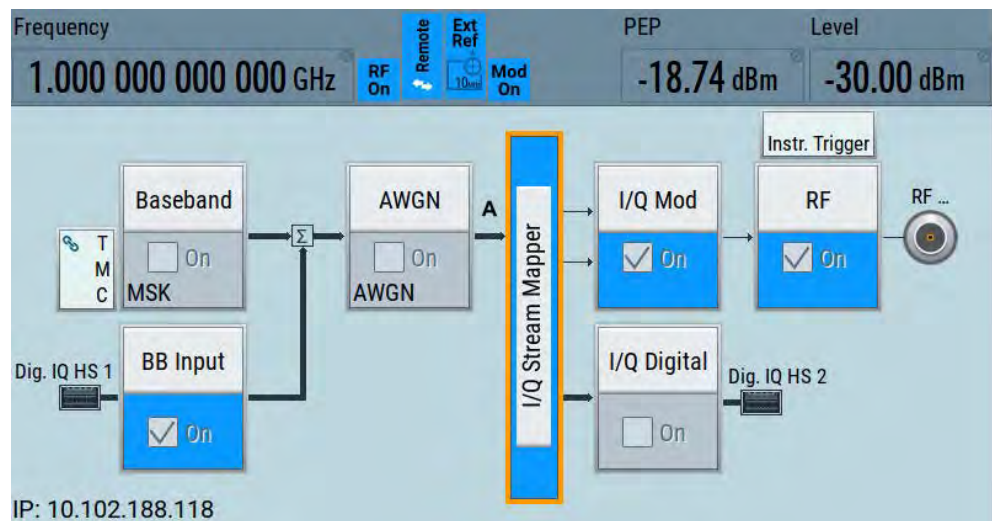

See "To establish a connection to the secondary instrument" on page 200.

2. Select "BB Input" > "Baseband Input Settings".

How to connect external instruments and configure the signal flow

The secondary instrument displays connection settings and the connected primary instrument.

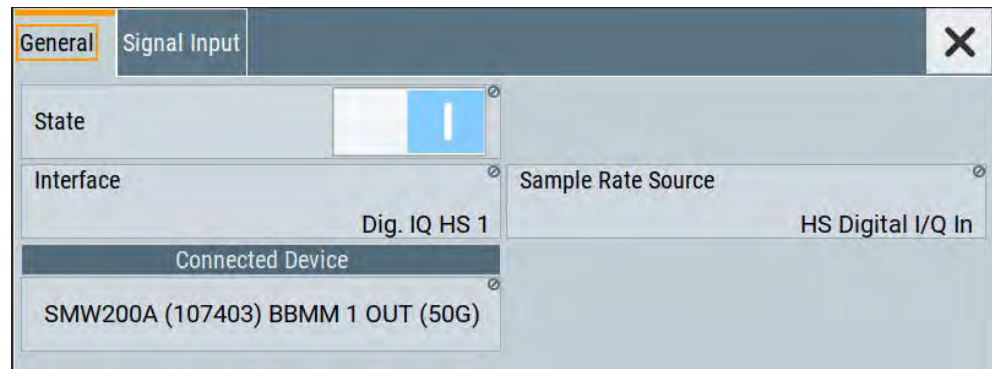

- In the block diagram, select "System Configuration" > "Multi Instrument".

The secondary instrument displays an enabled multi-instrument state and its use as a secondary instrument.

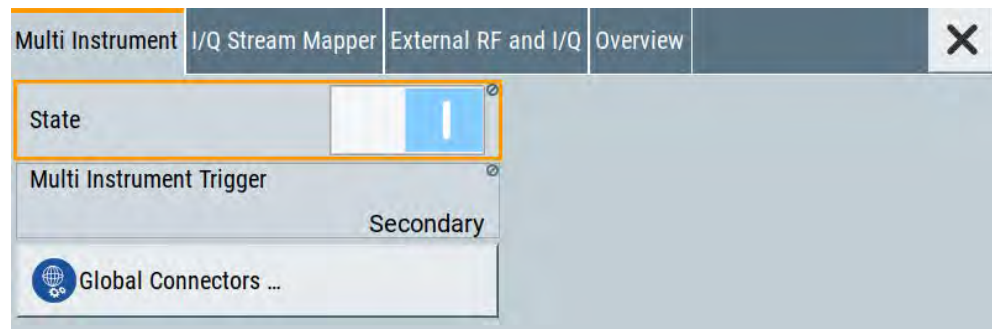

- Select "System Configuration" > "External RF and I/Q".

The secondary instrument displays an enabled connection to the primary instrument via the QSFP+ interfaces.

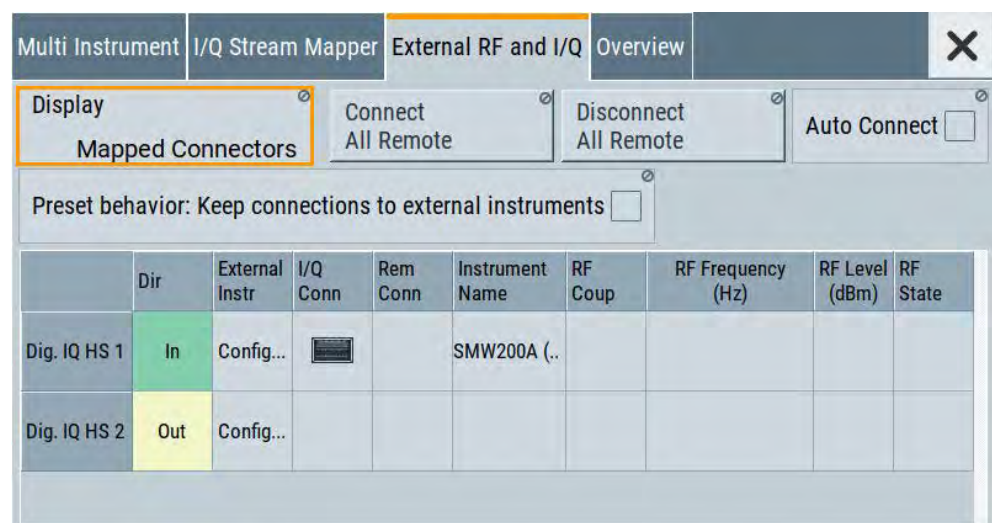

### 4.9.8 How to generate a 2x8 MIMO signal for BS tests

Refer to [Table 4-1](#) to find out the suitable system configuration and the required additional instruments for this particular test.

There are two suitable test setups:

- A test setup with one R&S SMW200A and six R&S SGT  
See "[Test setup with R&S SMW200A and 6xR&S SGT](#)" on page 203
- A test setup with multiplexed digital output signals

See user manual R&S SMW-K551 Generation of Digital "Slow IQ" Signals.

#### Test setup with R&S SMW200A and 6xR&S SGT

This test setup is a logical extension of the 1x4x4 test case.

Follow the instructions provided in the sections listed below but connect six R&S SGT instruments instead:

1. Connect all 8 instruments to a LAN.
2. Connect the six R&S SGT to the DIG I/Q interfaces of the R&S SMW200A (see [Figure 4-24](#) for explanation of the principle)
3. Distribute the *internal reference frequency* of R&S SMW200A to the other instruments.  
Connect the instruments in a daisy chain.
4. Perform the configurations described in:
  - [Section 4.9.3, "How to define the MIMO scenario"](#), on page 185
  - [Section 4.9.4, "How to route the I/Q streams to the output interfaces"](#), on page 187
  - ["To connect instruments to the I/Q digital interface"](#) on page 192
5. If the test setup requires a beamformed signal, **couple the local oscillators (LO) of all instruments**:
  - Activate the local oscillator of the R&S SMW200A.
  - Distribute the *LO signal* to the other instruments (instead of the reference frequency):

How to connect external instruments and configure the signal flow

- a) In the R&S SMW200A, select "RF > Reference Frequency/LO Coupling".  
 Select "LO Coupling Mode > A Internal& A->B Coupled".  
 Set "Out State > B On".

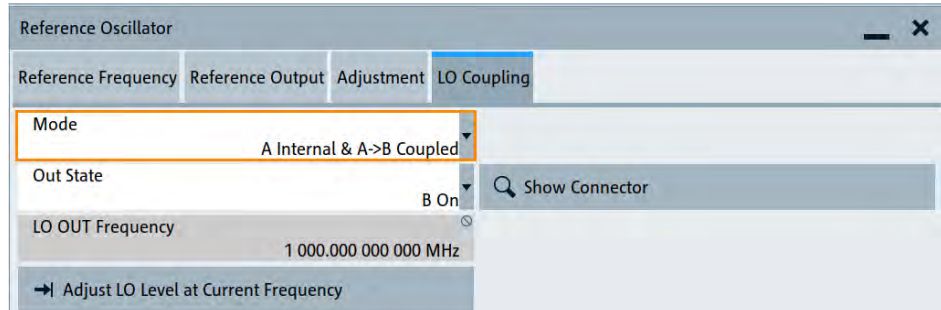

- See also "[To configure LO coupling with cascaded instruments](#)" on page 505.  
 b) Disconnect the cable from the REF OUT connector.  
 Connect it to the LO OUT connector of the R&S SMW200A.

The connected instruments are reconfigured automatically so that they use the supplied local oscillator signal.

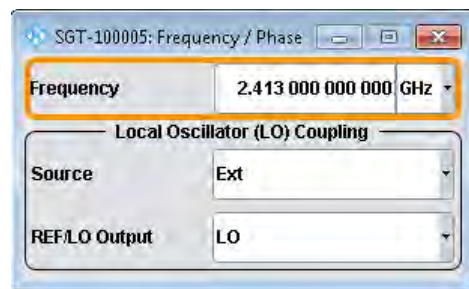

Figure 4-27: Example: Automatically configured settings in the connected external instrument

All connected instruments generate signals with the same RF frequency.

#### 4.9.9 How to generate a 8x8 MIMO signal with two R&S SMW200A

Option: R&S SMW-K821

Refer to [Table 4-1](#) to find out the suitable system configuration and the required additional instruments for this particular test.

This test setup requires two R&S SMW200As and four R&S SGS or four R&S SGT.

The 8x8 MIMO test setups require the signal of 8 Rx antennas and 64 fading channels. The R&S SMW200A calculates 32 fading channels but considers the correlation of all 64 channels. The instrument outputs four streams simultaneously. Two of the streams are output at the RF outputs. The other two streams can be routed to the analog and digital I/Q connectors and processed by a further processing instrument. (See [Section 4.9.5, "How to cable the instruments in MIMO test setups"](#), on page 188).

How to connect external instruments and configure the signal flow

A second R&S SMW200A is required to generate the **second subset of fading channels and streams**. Logically, for the processing of two of the four streams, two additional further processing instruments are required, too.

### Example of test setup

Figure 4-28 shows an 8x8 MIMO test setup with two R&S SMW200A and four R&S SGT connected to the digital I/Q outputs of the R&S SMW200A. You can use four R&S SGS instead, too.

In this example, we distribute the trigger signal generated by R&S SMW200A#1 to **trigger both instruments simultaneously**. You can trigger both instruments also with a common external trigger signal. If the latter is the case, consider to adapt the trigger connections and settings.

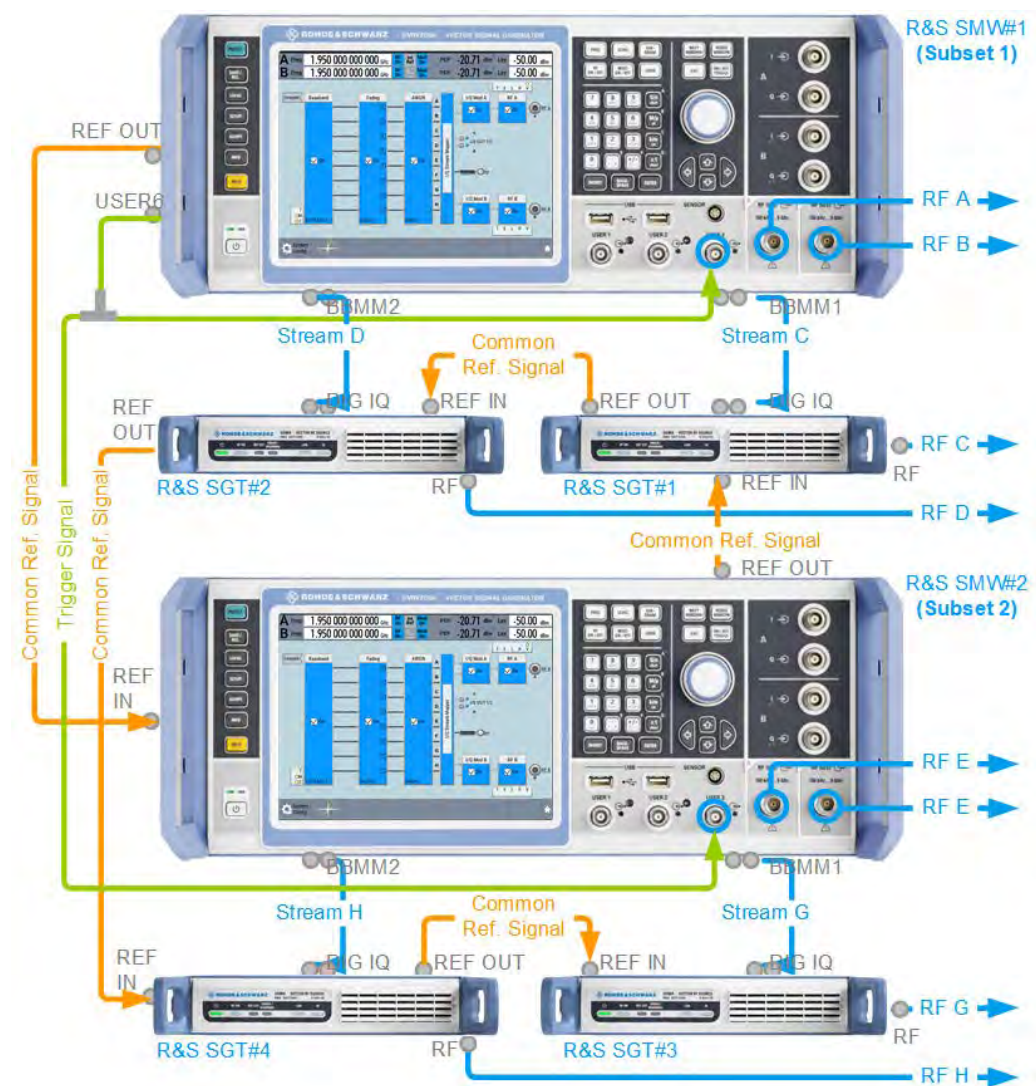

Figure 4-28: Example of test setup\*: 8x8 MIMO with 2xR&S SMW200A and 4xR&S SGT

blue circle = front panel connector

gray circle = rear panel connector

\* = To simplify the diagram, it does not show the LAN/USB connections between the instruments

### Workflow overview

1. Cabling  
See ["To cable the instruments"](#) on page 206.
2. Configuring the first R&S SMW200A  
See ["To configure the R&S SMW200A that simulates the first subset"](#) on page 207.
3. Configuring the second R&S SMW200A  
See ["To configure the R&S SMW200A that simulates the second subset"](#) on page 208.
4. Starting signal generation  
See ["To start signal generation"](#) on page 208

### To cable the instruments

Refer to [Figure 4-28](#) for illustration the required connections. The test setup does not show the LAN connections.

1. Connect all six instruments to a LAN.
2. Use suitable connecting cables.  
The connecting cables must have the same length and type, applies for the following connections:
  - REF OUT to REF IN
  - BBMM1/2 to DIG IQ
  - USER6 to both USER3 connectors
  - RF outputs to DUT
3. Avoid unnecessary cable lengths and branching points.
4. Provide the instruments with common reference frequency signal.  
In this test setup, the internal reference frequency of R&S SMW200A#1 is distributed to the other instruments. The instruments are connected in a daisy chain.
5. Use a T-connector to distribute the trigger signal generated by R&S SMW200A#1 and to trigger both instruments simultaneously:
  - a) Connect the instruments in a **star network**, concerning the trigger signal
  - b) Connect the USER 6 output of the R&S SMW200A#1 to the USER 3 input of R&S SMW200A#2 and the R&S SMW200A#1 itself.

In this test setup, the instruments are triggered by the trigger signal of the first one. For more information, see [Section 10.3.3, "Triggering several instruments with a common trigger signal"](#), on page 678.
6. Connect the external instruments to the digital I and Q connectors (BBMM 1 and 2) of the R&S SMW200A.

**Tip:** See also ["To find out the correct connector"](#) on page 184.

**To configure the R&S SMW200A that simulates the first subset**

1. Select "System Configuration".
2. Configure the following:
  - a) A 1x8x8 MIMO scenario with coupled sources.  
See ["To simulate complex MxN MIMO scenarios"](#) on page 185.
  - b) **"Subset = 1"**
  - c) Map the I/Q streams to the output interfaces as follows: Stream A and B to RF A and B; stream C and D to BBMM 1/2 respectively.  
See [Section 4.9.4, "How to route the I/Q streams to the output interfaces"](#), on page 187
3. Set "System Config. > Setup > Global Connectors" > **"User 6 > Direction = Output"**.  
Set **"User 6 > Signal = Manual Trigger"**.
4. Define the baseband signal, for example an LTE 8x8 MIMO signal. Alternatively, load 8 waveforms in the ARB generator.  
See also ["To define the baseband signal"](#) on page 186
5. For the selected baseband signal, configure the trigger settings:
  - a) Enable "Baseband > EUTRA/LTE > Trigger > Trigger Mode" > **"Armed Retrigger"**.
  - b) Select **"Trigger Source > Ext. Global Trigger 1"**.
  - c) Select "Sync Output to Ext. Trigger > On".

Per default, the "Ext. Global Trigger 1" signal is expected at **USER3**.
6. Select "Fading > Fading Settings":
  - a) Select "Restart" > **"Restart Mode > Baseband Trigger"**.
  - b) Configure the settings as required.  
The 8x8 MIMO configuration generates 64 correlated channels. Predefined channel models do not exist.
  - c) Select "Fading > State > On".
7. Select "Frequency = 1.95 GHz" and "Level = -50 dBm"
8. Configure each of the R&S SGT as described in ["To connect instruments to the I/Q analog interface"](#) on page 189.
9. Press the [SAVE/RCL] key to save the instrument setup, for example as `8x8_subset1.savrcltxt` file.

The RF outputs are active, the fading simulator is enabled but not running, the baseband generator is not active. The whole system is triggered jointly, as described in ["To start signal generation"](#) on page 208.

**To configure the R&S SMW200A that simulates the second subset**

1. Transfer the save/recall file (8x8\_subset1.savrc1.txt) to R&S SMW200A#2.
2. At the R&S SMW200A#2, press the [SAVE/RCL] key to load the file.

See also the following:

- [Section 11.9, "Transferring files from and to the instrument"](#), on page 725
- Application sheet RS SMW Fast Data Alignment on the R&S SMW200A product page.

3. Select "System Configuration" > "**Subset = 2**".
4. In the status bar, select the icon "Int. Ref".
5. Select "Reference Frequency" > "Source" > "External".
6. For the selected baseband signal, select "Baseband" > "EUTRA/LTE" > "Trigger".
7. Observe the settings.

We use the configuration from the first instrument, hence "**Trigger Source = External Global Trigger 1**" is selected. The R&S SMW200A expects the "Global Trigger 1" signal at the **USER3** connector.

8. Select "System Configuration" > "External RF and I/Q".
9. Select "Connect" for both external instruments.

The RF outputs are active, the fading simulator is enabled but not running, the baseband generator is not active. The whole system is triggered jointly, as described in "[To start signal generation](#)" on page 208.

**To start signal generation**

1. In **R&S SMW200A#2**, select "Baseband > On".
2. In the R&S SMW200A#1, select "Baseband > On".
3. To trigger the signal generation in both instruments from R&S SMW200A#1, select "**Global Connectors > Execute Trigger**".

The baseband generators and the fading simulators in both instruments start simultaneously.

**4.9.10 How to connect an R&S®CMW500 for fading applications**

Option: R&S SMW-B10 and R&S SMW-B14

You can use R&S SMW200A to superimpose fading on the baseband signal generated by an R&S®CMW500. The R&S SMW200A must be connected to the digital I/Q interface of the R&S®CMW500.

The [Table 4-12](#) lists the stream mapping for this configuration; the table entries show the stream to interface mapping in the order the related boards are on the instrument's rear panel.



Table 4-12: Overview of the stream mapping

Digital interface	Direction	Stream	Digital interface	Direction	Stream
CODER1	Input	Stream to Baseband A	CODER2	Input	Stream to Baseband B
FADER 1	Input	Stream to Baseband C	FADER 2	Input	Stream to Baseband D
FADER 3	Output	Stream C	FADER 4	Output	Stream D
BBMM 1	Output	Stream A	BBMM 2	Output	Stream B

The Figure 4-29 shows a 1x2x2 MIMO setup with two downlink paths using the connectors DIG IQ 1 to 4 of the R&S®CMW500. In this example, the R&S SMW200A is synchronized to a 10 MHz reference signal provided by the R&S®CMW500. The R&S®CMW500 also provides the R&S SMW200A with its trigger signal.

All connections between R&S SMW200A and the R&S®CMW500 are established via the rear panels of the instruments.

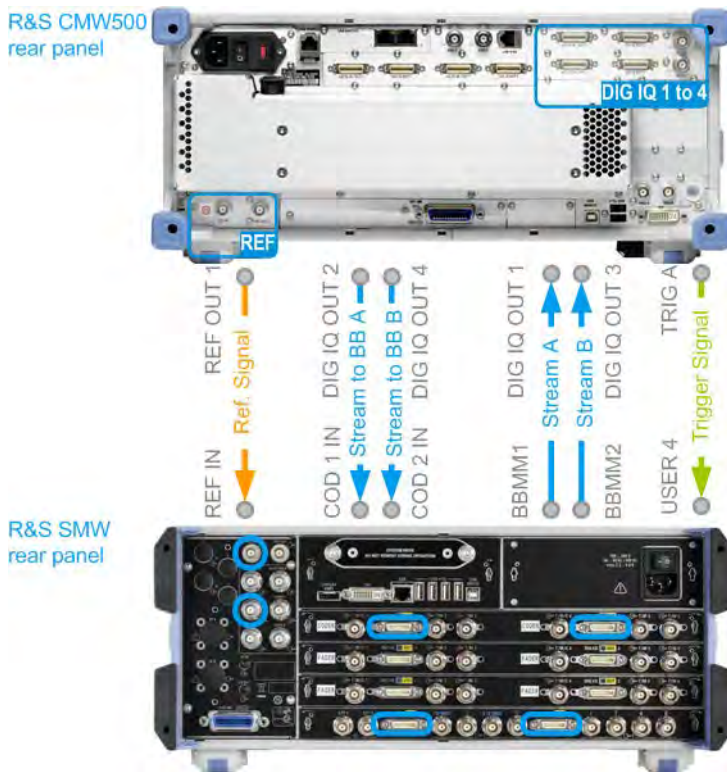

Figure 4-29: Example of test setup: 1x2x2 MIMO with 1xR&S SMW200A and 1xR&S CMW500 connected to the DIG I/Q interfaces

### 4.9.11 How to apply an external digital baseband signal

See:

- "To provide an external digital signal to the instrument" on page 210
- "To apply an external analog signal directly to the I/Q modulator" on page 211
- "To apply an external differential analog signal directly to the I/Q modulator" on page 212

#### To provide an external digital signal to the instrument

Option: R&S SMW-B10



A digital signal must be provided. The instrument displays an error message if no signal is applied at the digital input connector.

The external signal source, typically a second Rohde & Schwarz instrument, and the receiving instrument have to be synchronized, i.e. they have to use a common reference signal.

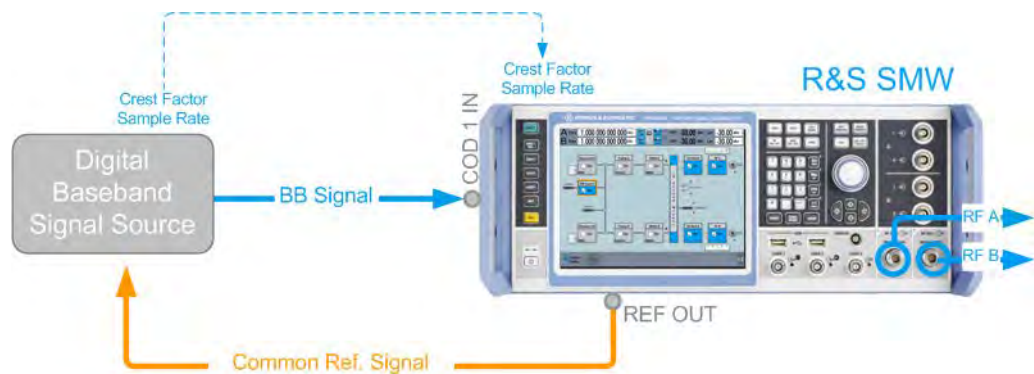

Figure 4-30: Example of test setup (simplified, standard baseband)

The procedure describes the configuration in the *default state of the instrument*, i.e. "System Config > Fading/Baseband Configuration > Mode > Standard".

1. Connect the external digital signal source to one of the digital input interfaces of the instrument, e.g. the CODER1.
2. If the "BB Input" block is not displayed in the block diagram, select the input symbol "CODER 1".
3. Select "BB Input > Signal Routing".  
Adjust the required signal switching.
4. Select "BB Input > Baseband Offsets".  
Adjust the frequency offset and the path gain settings, if necessary.
5. In the "Baseband Input Settings > Sample Rate" dialog, adjust the sample rate source and value.

How to connect external instruments and configure the signal flow

6. In the "Baseband Input Settings > Input Level Settings" dialog adjust the "Crest Factor", "Peak Level" and "Level" values of the external input signal in one of the following ways:
  - a) Find out these values.
  - b) Enter them manually.
  - c) Set appropriate "Measurement Period" and trigger "Auto Level Set".  
To ensure accurate level measurements, select a measurement period that is long enough to capture several periods of the input signal.
  - d) Enable "DIG IQ Auto Settings"  
The R&S SMW200A receives peak level, level and crest factor values directly from the connected transmitter and recognizes changes automatically.

Based on these values, the internal gain control adjusts the input signal gain to achieve an optimal dynamic range.

**Tip:** Achieving correct signal leveling with external baseband signals requires one measurement per each baseband source with an appropriate measurement time. Perform the same steps in the other basebands, if an external digital signal is fed to the other digital input connectors.
7. In the "Baseband Input Settings" dialog, configure the other settings as required.
8. Select "Baseband Input Settings > General > State > On" to enable the processing of the external digital signal.
9. Open "Baseband Input Settings > Signal Monitoring" and monitor the signal overflow status.

#### To apply an external analog signal directly to the I/Q modulator

Fed the external analog wideband signal at the I/Q input connectors (see [Table 4-3](#)). The signal is used as an input signal for the I/Q modulator.



Figure 4-31: Example of test setup (simplified)

1. To configure the input signal source of the I/Q modulator, select "I/Q Mod > I/Q Mod In > Analog Wideband I/Q In".
2. To access the dialog box for configuring the I/Q modulator settings, select "I/Q Mod > I/Q Settings > I/Q Modulator".

Refer to [Section 7, "Applying I/Q vector modulation"](#), on page 458 for a description of the settings.

3. In the "I/Q Modulator" dialog, select "General > Analog Wideband I/Q Input > Crest Factor".  
Adjust the crest factor and gain values.
4. To impair the analog signal, adjust the "I/Q Modulator > Impairments" settings (see also [Section 6.4, "Impairing the signal"](#), on page 449).
5. Select "I/Q Mod > On" or "I/Q Mod > I/Q Modulator > General > State > On" to enable the processing of the external analog signal.

#### To apply an external differential analog signal directly to the I/Q modulator

1. Select "I/Q Mod > I/Q Settings > Source > Differential Analog I/Q Input".
2. Follow the steps described in ["To apply an external analog signal directly to the I/Q modulator"](#) on page 211.

### 4.9.12 How to connect an R&S EX-IQ-BOX

Option: R&S SMW-B10

Transmission of digital I/Q signals to a DUT requires that the signals are adjusted to the type of interface, including its physical properties, and to the corresponding transmission protocol. While Rohde & Schwarz instruments generally communicate via a proprietary transmission protocol that is based on LVDS, many different interfaces and communication protocols have evolved in digital I/Q transmission.

To meet many of these variants in a convenient way, you can use the R&S EX-IQ-BOX as a downstream converter. The R&S EX-IQ-BOX is a configurable digital interface module, designed to convert digital I/Q signals of the Rohde & Schwarz instruments into *user defined* or *standardized* signal formats. The R&S EX-IQ-BOX uses breakout boards for signal conversion. These boards adjust the signal physically.

See:

- ["Basic test setup with the R&S EX-IQ-BOX"](#) on page 212
- ["To set up the R&S EX-IQ-BOX and R&S DigIConf"](#) on page 213
- ["To connect an R&S EX-IQ-BOX operating in transmitter mode to the instrument"](#) on page 213

#### Basic test setup with the R&S EX-IQ-BOX

The [Figure 4-32](#) shows the cabling of a basic test setup with the R&S SMW200A, a connected R&S EX-IQ-BOX and a DUT. The R&S EX-IQ-BOX is configured via USB by the digital interface configuration software R&S DigIConf, running on a PC. The R&S EX-IQ-BOX operates in transmitter mode from the R&S SMW200A to the DUT.

How to connect external instruments and configure the signal flow

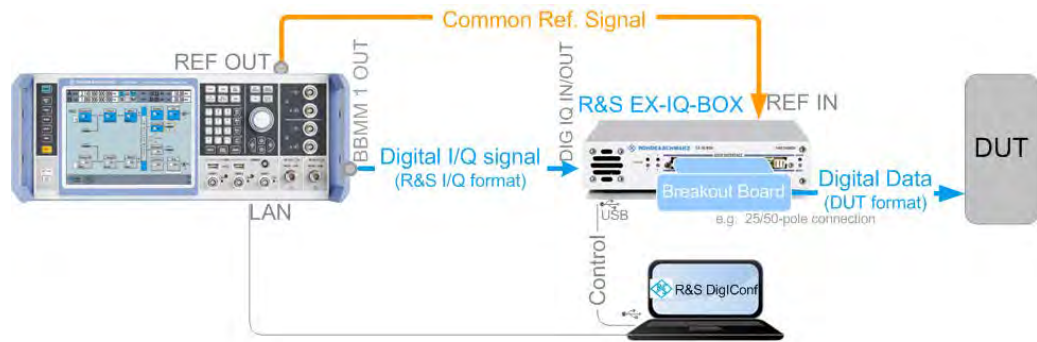

Figure 4-32: Basic test setup with R&S SMW200A and an R&S EX-IQ-BOX operating in transmitter mode



This section describes how to configure a basic setup with the R&S SMW200A and R&S EX-IQ-BOX, including the cabling, installing the configuration software, and connecting the instruments.

For more information, refer to the R&S EX-IQ-BOX Operating Manual.

#### To set up the R&S EX-IQ-BOX and R&S DigiConf

1. Disconnect all R&S EX-IQ-BOX instruments from controller PC.
2. Download the setup file `DigIConf_x.xx.xxx.exe` from the R&S website: [www.rohde-schwarz.com/product/EX-IQ-Box.html](http://www.rohde-schwarz.com/product/EX-IQ-Box.html)
3. Install the configuration software R&S DigiConf on the controller PC.
4. Plug the required breakout board to the user interface of the R&S EX-IQ-BOX.
5. Connect the R&S EX-IQ-BOX to the AC supply.
6. Connect the USB cable between the USB IN of the R&S EX-IQ-BOX and the PC.
7. Start R&S DigiConf.

The application starts. The main view of R&S DigiConf shows the connected R&S EX-IQ-BOX.

#### To connect an R&S EX-IQ-BOX operating in transmitter mode to the instrument

1. Connect the required cable to the DIG I/Q IN connector of the R&S EX-IQ-BOX to the BBMM1 connector of the R&S SMW200A.  
See [Figure 4-32](#).

The R&S SMW200A recognizes this external digital signal interface module automatically and indicates a labeled symbol of the R&S EX-IQ-BOX at the "Block Diagram > I/Q Digital" block.

R&S DigiConf also indicates a separate function block with information on the R&S SMW200A, the currently used interfaces, and the signal flow.

2. Select "Block Diagram > I/Q Digital > Sample Rate > Source > Digital IQ IN".

3. Adjust further required settings.
4. To access information on the recognized R&S EX-IQ-BOX components, select "Setup > Hardware Config > Baseband Assembly".  
For more information, refer to the R&S EX-IQ-BOX Operating Manual.



See user manual R&S SMW-K551 Generation of Digital "Slow IQ" Signals.

## 5 Configuring the internal baseband source

The R&S SMW200A is a vector signal generator with internal signal generation and real-time functionality and with integrated arbitrary waveform generator.

The instrument enables you to generate various digital modulation signals in accordance with the definitions in the corresponding specifications or with user-definable characteristics. Signals are generated in realtime or played from a data store with external and internal data. The instrument provides an interface for the loading of externally computed modulation signals in form of waveform files.

This section covers the following topics:

- [Overview of the signal generation modes](#).....215
- [Standard or wideband baseband generator](#).....216
- [Accessing the functions in the baseband domain](#).....218
- [Generating signals according to digital standards](#)..... 219
- [Common characteristics of the baseband domain](#).....223
- [Generating custom digital modulation signals](#).....266
- [Using the arbitrary waveform generator \(ARB\)](#).....302
- [Generating notched signals](#).....353
- [Reducing the crest factor](#).....360
- [Generating multi-segment waveform files](#).....360
- [Generating multicarrier waveform signals](#).....391
- [Generating multicarrier continuous wave signals](#).....408
- [Generating a linear slope ramp waveform](#).....418
- [Shifting the baseband signal](#).....418

### 5.1 Overview of the signal generation modes

The R&S SMW200A can generate the signal in the following ways:

- [Generating digital standard signals](#)
- [Generating a real-time signal](#)
- [Playing a waveform](#)

#### Generating digital standard signals

Provided the instrument is equipped with the required digital standard options, the instrument can generate digital standards in accordance with the corresponding specifications.

The required options are specified in the description of the respective digital standard (see the corresponding user manual).

See also [Section 5.4, "Generating signals according to digital standards"](#), on page 219.

### Generating a real-time signal

- While utilizing the *internal* signal generator, the R&S SMW200A generates the digital modulation signals with user-definable characteristics in real time.  
See also [Section 5.6, "Generating custom digital modulation signals"](#), on page 266.
- If the required options are installed, *externally supplied real-time* baseband signals can be added to the internally generated signals.  
See also [Section 4.6, "Digital baseband input settings"](#), on page 151.

### Playing a waveform

The R&S SMW200A is equipped with an arbitrary waveform generator (ARB) used to generate test signals and to process waveform files. Waveforms are files with settings provided for repeatable tests with the same test signal. Irrespectively of the way these waveform files are generated, they are always played from the instrument. That is, the signal calculation is performed in advance and the instrument reacts as a player.

- Externally computed waveform files can be loaded in the instrument over the LAN, USB, or the GPIB interface.  
Create waveforms, for example, with the signal generation software R&S WinIQ-SIM2 or the R&S®Pulse Sequencer software.
- The instrument provides different functions to generate waveforms *internally*.
  - Some of the digital standards firmware options provide the possibility to store the current signal settings into a waveform file. These waveform files can be loaded in and processed as multi-carrier or multi-segment signal by the ARB generator.  
See also [Section 5.7, "Using the arbitrary waveform generator \(ARB\)"](#), on page 302.
  - Multi-carrier waveforms consisting of carriers modulated by different baseband signals can be configured and created internally. Such multi-carrier waveform files are required to simulate complex multi-carrier scenarios with different baseband signals, e.g. CDMA2000, 3GPP FDD, or signals in accordance with the LTE-Advanced specifications.  
See also [Section 5.11, "Generating multicarrier waveform signals"](#), on page 391.
  - Provided the instrument is equipped with the corresponding option, it is also possible to generate multi-carrier waveforms consisting of unmodulated carriers  
See also [Section 5.12, "Generating multicarrier continuous wave signals"](#), on page 408.

## 5.2 Standard or wideband baseband generator

The R&S SMW200A can be equipped with a standard or with a dedicated wideband baseband section.



- The term **standard baseband** instrument describes R&S SMW200A equipped with at least option Baseband Generator R&S SMW-B10 and baseband main module (R&S SMW-B13/B13T).
- The term **wideband baseband** instrument describes R&S SMW200A equipped with at least option Wideband Baseband Generator R&S SMW-B9 and Wideband baseband main module (R&S SMW-B13XT).

If fully equipped, the R&S SMW200A with standard baseband generates signals with up to 160 MHz bandwidth and modulates them on up to 40 GHz.

The fully equipped wideband baseband generator extends the internal RF modulation bandwidth to 2 GHz. With this option, the R&S SMW200A generates wideband vector modulated signals with up to 40 GHz carrier frequency using a single device.

### Standard baseband versus wideband baseband

The R&S SMW200A can be equipped with a standard or with a wideband internal baseband generator. Regarding the RF performance, both generators offer similar characteristics.

The choice which baseband generator to use, depends merely on the application:

- The **standard baseband** generator is the best choice in applications that require multichannel, MIMO or MSR scenarios.  
You find an insight of possible test scenarios in [Section 4.1.2, "Test scenario and required system configuration"](#), on page 102.
- The **wideband generator** offers an internal modulation bandwidth of 2 GHz. With its leading-edge baseband capabilities, it is designed for demanding wideband signal simulations.

See [Table 5-1](#) for an overview of the major characteristics of the R&S SMW200A.

*Table 5-1: R&S SMW200A with standard or wideband generator: Overview of the main characteristics*

Characteristics	Standard baseband	Wideband generator
Max signal bandwidth	160 MHz	2 GHz
Max RF frequency	67 GHz	67 GHz
Max baseband frequency offset	±80 MHz	±1 GHz
Signal generation mode	Real time and ARB	Real time and ARB
Max ARB waveform length	1 Gsample	2 Gsample
Max clock rate	200 MHz	2.4 GHz
Internal frequency response compensation	Yes	Yes
Multichannel and MIMO configurations	Yes	No

For more information, refer to the specifications document.

### Main application fields of R&S SMW200A equipped with standard generator

- Complex multichannel scenarios
- Versatile MIMO configurations

- MSR or LTE-Advanced applications
- Fading and noise simulation
- Wireless communications applications
- Radar and satellite applications
- Beamforming applications

#### Main application fields of R&S SMW200A equipped with wideband generator

- Wideband receiver testing
- Single box solution for coexistence testing with LTE
- Next generation of mobile communication signals, like 5G waveforms
- IEEE 802.11ad signals generation at IF frequency
- Aerospace and defense applications
- Advanced receiver testing of wideband radar modules
- Multicarrier signal with a bandwidth of up to 2 GHz
- Wideband signals also in the microwave range

#### Where to find related information

This description assumes a fully equipped [Standard baseband](#) R&S SMW200A, so that we can explain all instrument concepts and show the possible configuration and settings. If a particular function requires a special option, this option is stated in the list of the required options.

If your instrument is equipped with [Wideband baseband](#) generator, some sections of this description are not relevant. Refer to the list of required options in the corresponding section to check if the description applies in your case.

Note that the values ranges in the remote control commands correspond to a [Standard baseband](#) instrument.

## 5.3 Accessing the functions in the baseband domain



1. In the block diagram, select the "Baseband" block.
2. Navigate through the context menu.



The "Baseband" block provides all functions and settings to configure the baseband signal. The functions and settings include all generation modes as described in the [Section 5.1, "Overview of the signal generation modes"](#), on page 215.

3. By default, baseband signal generation is off.  
To activate the baseband generator, in the block diagram, select the "Baseband" block and set "Baseband > On".

A short designation indicates the digital standard or modulation currently selected. The designation "Digital I/Q In" indicates that the instrument uses the external digital baseband signal, see [Section 4.6, "Digital baseband input settings"](#), on page 151.

For information, see:

- [Section 5.6, "Generating custom digital modulation signals"](#), on page 266
- [Section 5.7, "Using the arbitrary waveform generator \(ARB\)"](#), on page 302
- [Section 5.12, "Generating multicarrier continuous wave signals"](#), on page 408
- The description of the digital standards
- [Section 5.14, "Shifting the baseband signal"](#), on page 418

## 5.4 Generating signals according to digital standards

The R&S SMW200A generates digital signals in accordance with the specifications of the main communication and radio standards only if the corresponding firmware options are installed.

This section lists the supported standard-compliant digital signals that run on the **standard baseband** or **wideband baseband** generator.

The following standards do not run on the **wideband baseband** generator (option R&S SMW-B9):

- "IEEE 802.16 WiMAX™" on page 222
- "NFC/EMV" on page 223

### **GSM/EDGE, EDGE Evolution**

This digital standard requires an instrument equipped with the GSM/EDGE and EDGE Evolution options R&S SMW-K40/-K41.

The GSM/EDGE, EDGE Evolution options provide functionality to generate signals in accordance with the GSM/EDGE standard. GSM/EDGE signals comprise GMSK and 8PSK modulation and higher order modulations that are in accordance with the EDGE Evolution standard.

For details, see the R&S SMW200A GSM/EDGE user manual.

### **Bluetooth® BR/EDR/LE/Channel Sounding**

This digital standard requires an instrument equipped with the Bluetooth® options R&S SMW-K60/-K117/-K178.

The Bluetooth® options provide functionality to generate signals in accordance with the Bluetooth® core specification for Bluetooth® Classic and Bluetooth® 5.x Low Energy operation. For the latest version, see the latest Bluetooth® core specification document.

For details, see the R&S SMW200A Bluetooth® Signal Generation user manual.

### **TETRA Release 2**

This digital standard requires an instrument equipped with the TETRA Release 2 option R&S SMW-K68.

The TETRA Release 2 option provides functionality to generate signals in accordance with the standard Terrestrial Trunked Radio Release 2 (TETRA2).

For details, see the R&S SMW200A TETRA Release 2 user manual.

### **LoRa**

This digital standard requires an instrument equipped with the LoRa option R&S SMW-K131.

The LoRa option provides functionality to generate signals in accordance with the Semtech Corporation, Camarillo California, USA proprietary standard.

For details, see the R&S SMW200A LoRa user manual.

### **3GPP FDD incl. enhanced MS/BS tests, HSPA, HSPA+**

This digital standard requires an instrument equipped with the 3GPP FDD incl. enhanced MS/BS tests, HSPA, HSPA+ options R&S SMW-K42/-K83.

These options provide functionality to generate signals in accordance with the WCDMA standard 3GPP FDD.

For details, see the R&S SMW200A 3GPP FDD user manual.

### **CDMA2000®**

This digital standard requires an instrument equipped with the CDMA2000 option R&S SMW-K46.

The CDMA2000 option provides functionality to generate signals in accordance with the CDMA2000 standard 3GPP2 C.S0002-C, version 1.0 (release C).

For details, see the R&S SMW200A CDMA2000 user manual.

### **TD-SCDMA and TD-SCDMA enhanced features**

This digital standard requires an instrument equipped with the TD-SCDMA and TD-SCDMA enhanced features options R&S SMW-K50/-K51.

The TD-SCDMA options provide functionality to generate signals in accordance with the TD-SCDMA (3GPP TDD LCR) standard.

For details, see the R&S SMW200A TD-SCDMA user manual.

### **1xEV-DO Rev. A and Rev. B**

This digital standard requires an instrument equipped with the 1xEV-DO Rev. A and Rev. B options R&S SMW-K47/-K87.

The 1xEV-DO options provide functionality to generate signals in accordance with the CDMA2000 1xEV-DO (Evolution-Data Optimized), Rev. A and Rev. B standard.

For details, see the R&S SMW200A 1xEV-DO Rev. A Rev. B user manual.

### **IEEE 802.11a/b/g/n/p/j, IEEE 802.11ac, IEEE 802.11ax, IEEE 802.11be**

These digital standards require an instrument equipped with the WLAN options R&S SMW-K54/-K86/-K142/-K147.

These options provide functionality to generate signals in accordance with the WLAN standards IEEE 802.11a/b/g/n/ac/p/j/ax/be.

For details, see the R&S SMW200A IEEE 802.11 WLAN user manual.

### **IEEE 802.11ad, IEEE 802.11ay**

These digital standards require an instrument equipped with a wideband baseband generator option R&S SMW-B9, IEEE 802.11ad option R&S SMW-K141 and the IEEE 802.11ay option R&S SMW-K177.

These options provide functionality to generate signals in accordance with the WLAN standards IEEE 802.11ad and IEEE 802.11ay.

For details, see the R&S SMW200A IEEE 802.11ad/ay user manual.

### **HRP UWB 802.15.4**

This functionality requires an instrument equipped with the HRP UWB 802.15.4 option R&S SMW-K149.

This option provides functionality to generate signals in accordance with the HRP UWB standard.

For details, see the R&S SMW200A HRP UWB 802.15.4 user manual.

### **EUTRA/LTE Rel. 8, Rel. 9, Rel. 10, Rel. 11, Rel. 12, Rel. 13/14, Cellular IoT, incl. Enhancements**

This digital standard requires an instrument equipped with the EUTRA/LTE options R&S SMW-K55/-K69/-K81/-K84/-K85/-K112/-K113/-K115/-K119/-K143.

These options provide functionality to generate signals in accordance with the 3GPP standard EUTRA/LTE Rel. 8, Rel. 9, Rel. 10, Rel. 11, Rel. 12 and Rel. 13/14.

### **5G NR**

This functionality requires an instrument equipped with the 5G NR option R&S SMW-K144.

This option provides functionality to generate signals in accordance with the 3GPP standard release 17.

For details, see the R&S SMW200A 5G NR user manual.

### **Verizon 5GTF**

This digital standard requires an instrument equipped with the Verizon 5GTF option R&S SMW-K118.

This option provides functionality to generate signals based on the Verizon 5G open trial specifications <http://5gtf.org/>.

For details, see the R&S SMW200A Verizon 5GTF user manual.

### **OFDM Signal Generation**

This functionality requires an instrument equipped with the OFDM Signal Generation option R&S SMW-K114.

This option provides functionality to generate OFDM signals and signals according to predefined OFDM modulation schemes.

For details, see the R&S SMW200A OFDM Signal Generation user manual.

### **IEEE 802.16 WiMAX™**

This digital standard requires an instrument equipped with the IEEE 802.16 WiMAX option R&S SMW-K49.

The IEEE 802.16 WiMAX option provides functionality to generate signals in accordance with the IEEE 802.16 standard WiMAX.

For details, see the R&S SMW200A WiMAX user manual.

### **OneWeb**

This functionality generates signals based on the OneWeb specification.

For details, see the R&S SMW200A OneWeb user manual.

### GNSS

These digital standards require an instrument equipped with the GNSS options R&S SMW-B9F/-K44/-K66/-K94/-K97/-K98/-K106/-K107/-K108/-K109/- K122/-K123/-K128/-K129/-K132/-K134/-K135/-K136/-K137/-K138/-K139.

The GNSS options provide functionality to generate signals in accordance with satellite navigation standards and to turn the R&S SMW200A into a GNSS simulator.

For details, see the R&S SMW200A Satellite Navigation user manual.

### GBAS

This digital standard requires an instrument equipped with the option R&S SMW-K111.

The GBAS option provides functionality to generate signals in accordance with the Ground-Based Augmentation System (GBAS) standard.

For details, see the R&S SMW200A GBAS user manual.

### DVB-H/T, DVB-S2/S2X, DVB-RCS2

This digital standard requires an instrument equipped with the DVB options R&S SMW-K52/-K116/-K169/-K176.

The DVB options provide functionality to generate signals in accordance with the digital video broadcasting standards DVB-H, DVB-S2/S2X/S2X-E and DVB-RCS2.

For details, see the R&S SMW200A Digital Video Broadcasting Options user manual.

### NFC/EMV

This digital standard requires an instrument equipped with the NFC/EMV option R&S SMW-K89.

The NFC/EVM option provides functionality to generate signals in accordance with the short-range wireless connectivity technology NFC-A/B/F and the EMV standard.

For details, see the R&S SMW200ANFC A/B/F user manual.

## 5.5 Common characteristics of the baseband domain

This chapter describes characteristics that are common to many baseband signal generation tasks. These characteristics are independent from the selected baseband signal source, for example, the selected digital standard.

For specific signal generation tasks, there can be specific settings that can deviate from common baseband signal generation settings. For example, a specific signal generation task is to generate a signal according to a digital standard.

### 5.5.1 About common baseband characteristics

This section provides general information on common baseband signals including signal sources and signal types, modulation types and coding schemes and baseband filtering and clipping.

#### Signal sources

In the baseband domain, you can generate internal signals or input external signal. Control signals however are always generated internally.

Depending on the current configuration, the internally generated data and marker signals are output on one or several connectors. The output capabilities of the instrument and the required connectors are configurable.

#### Signal types

For the generation of modulation signals, the instrument uses the following input signals:

- ["Internal modulation data"](#) on page 225
- ["External modulation data"](#) on page 226
- [Section 5.5.1.3, "About control signals"](#), on page 229

See also [Section 12.2, "Configuring local and global connectors"](#), on page 742.

This section describes common characteristics of the signals used for generating the baseband signal for all standards. Common characteristics do not depend on the generation mode.

The selection in the dialogs at any given time depends on the parameter and standard concerned. It is clear from the selection list offered in the dialog. Some parameters are therefore not available in certain cases. Characteristics specific to particular standards are described in the corresponding user manual.

- [About data signals](#).....224
- [About clock signals](#)..... 227
- [About control signals](#).....229
- [About marker signals](#)..... 231
- [About trigger signals](#)..... 235
- [Supported modulation signals](#).....245
- [Supported coding schemes](#).....246
- [Supported baseband filters](#)..... 247
- [Methods for optimizing the crest factor](#)..... 249

#### 5.5.1.1 About data signals

For the generation of modulation signals, the instrument uses the following input signals:

- ["Internal modulation data"](#) on page 225
- ["External modulation data"](#) on page 226
- [Section 5.5.1.3, "About control signals"](#), on page 229



### Internal modulation data

The R&S SMW200A uses the following internal modulation data sources:

- Data lists**  
 Data lists are externally or internally created binary lists with modulation data. The instrument provides a standard file select function for loading of existing data lists, creating internally new data lists or editing an existing one. Internally, data lists are created in the dedicated "Data List" editor (see [Section 5.6.3.7, "Data list editor"](#), on page 282). A separate file is created for each list and saved on the instrument's internal memory (hard disk). The filename is user-defined; the file extension is \*.dm\_iqd.  
 The maximum length of a data list is determined by the size of the data list memory. There is no restriction on the number of lists that can be saved.  
 Settings for file handling, like transferring external data lists to the instrument, or renaming of folders and files, are accessed via the standard "File Manger" function. (See also [Section 11, "File and data management"](#), on page 699).
- Data patterns**  
 Simple data patterns such as binary 0 ("All 0") strings or 1 ("All 1") strings or variable bit strings with a maximum length of 64 bits can be used as internal modulation data.
- PRBS data**  
 The PRBS generators deliver pseudo random binary sequences of differing length and duration. They are known as maximum length sequences. PRBS sequences are generated with the aid of ring shift registers with feedback points determined by the polynomial.  
 The pseudo-random sequence from a PRBS generator is uniquely defined by the register number and the feedback. The [Table 5-2](#) describes the available PRBS generators.  
 For PRBS15 and PRBS23, a CCITT V.52-compliant data inversion is performed in the feedback path automatically.

For more information, refer to the specifications document.

**Table 5-2: Overview of PRBS generators**

PRBS generator	Sequence length /bit	Feedback to	GUI selection
9-bit	$2^9 - 1 = 511$	Registers 4, 0	"PRBS 9"/"PN9"
11-bit	$2^{11} - 1 = 2047$	Registers 2, 0	"PRBS 11"/"PN11"
15-bit	$2^{15} - 1 = 32767$	Registers 1, 0	"PRBS 15"/"PN15"
16-bit	$2^{16} - 1 = 65535$	Registers 5, 3, 2, 0	"PRBS 16"/"PN16"
20-bit	$2^{20} - 1 = 1048575$	Registers 3, 0	"PRBS 20"/"PN20"
21-bit	$2^{21} - 1 = 2097151$	Registers 2, 0	"PRBS 21"/"PN21"
23-bit	$2^{23} - 1 = 8388607$	Registers 5, 0	"PRBS 23"/"PN23"

**Example:**

By way of example, the diagram on [A 9-bit PRBS generator](#) shows a 9-bit generator with feedback to registers 4 and 0 (output). The generated serial data is converted internally, e.g 2 Bit/Symbol if QPSK is used.

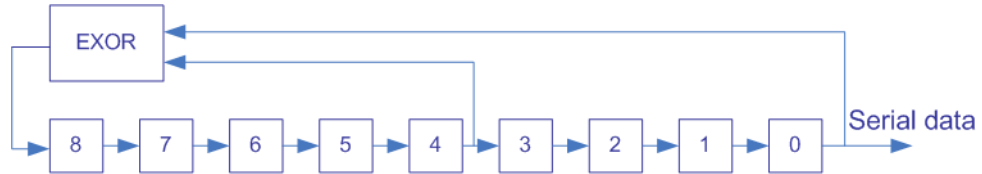

**Figure 5-1: A 9-bit PRBS generator**

Related settings:

- [Section 5.6.3.3, "Data source settings"](#), on page 270
- [Section 5.6.3.7, "Data list editor"](#), on page 282
- [Section 5.6.3.8, "Control and marker lists editor"](#), on page 284
- "Data Source" selection in the dialogs of the firmware options

**External modulation data**

Option:

- R&S SMW-B10
- R&S SMW-B9, only in "System Config > Mode > Advanced".

The R&S SMW200A can generate a custom digitally modulated signal from an external serial data source.

For proper synchronization, the R&S SMW200A requires a reference (external) symbol clock signal to generate a bit clock out of it. The active edge of both, the symbol clock and the bit clock, is configurable. Positive and negative timing deviations between the clock and the data signals are indicated and automatically corrected.

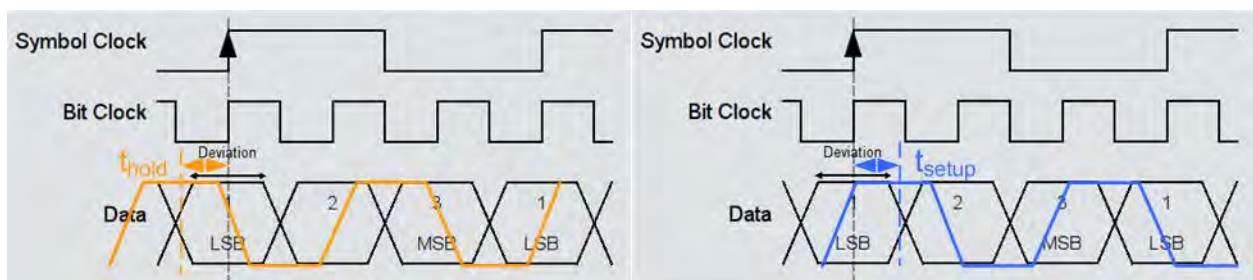

**Figure 5-2: Timing deviations ( $t_{\text{hold}}$  and  $t_{\text{setup}}$ ) between the clock and the data signals**

$t_{\text{hold}}$  = "Timing Deviation < 0": data signal is received ahead of the clock signal. Data is held and output synchronous to the clock signal.

$t_{\text{setup}}$  = "Timing Deviation > 0": the clock signal is received ahead of the data signal; the processing is held until the data is received

See also ["Synchronizing data signals and clock signals"](#) on page 229.

Supply the external data signal and in R&S SMW200A equipped with standard baseband the external clock signal via the connectors listed in:

- [Table 5-3](#)
- R&S SMW-B10: [Table 5-5](#)

**Table 5-3: Input connectors for the external serial data**

Baseband generator	Connector	Location	GUI selection
Standard (R&S SMW-B10)	T/M 2 T/M 5	Local connector on the coder board	To configure the connector: <ul style="list-style-type: none"> <li>• "Custom. Dig. Mod &gt; Clock Settings &gt; Local Connectors &gt; Direction &gt; Input"</li> <li>• "Custom. Dig. Mod &gt; Clock Settings &gt; Local Connectors &gt; Signal &gt; Data"</li> </ul> To enable the data source: <ul style="list-style-type: none"> <li>• "Custom. Dig. Mod &gt; Data Source &gt; Data Source &gt; External Serial"</li> </ul>
Wideband (R&S SMW-B9)	T/M 2	Local connector on the coder board	Connector configuration is not required. This signal is the default one, if "Custom. Dig. Mod > Data Source > Data Source > External Serial".

The instrument can process the external serial data in the least significant bit (LSB first) or in the most significant bit (MSB first) orders.

For more information, refer to the specifications document.

Related settings: "[Settings for Data Source > External](#)" on page 273.

### 5.5.1.2 About clock signals

The instrument requires an internal or an external clock reference for generating the timing pulse:

- **Internal clock reference**  
The instrument uses its internal clock reference.  
The internally generated symbol clock signal can be output at the local T/M/C connectors. The [Table 5-4](#) gives an overview.

**Table 5-4: Output connectors for the reference clock signal**

Baseband generator	Connector	Location	GUI selection
Standard (R&S SMW-B10)	T/M/C	Local connectors on each board	To configure the connector: <ul style="list-style-type: none"> <li>"Custom. Dig. Mod/Digital Standard &gt; Clock Settings &gt; Local Connectors &gt; Direction &gt; Output"</li> <li>"Custom. Dig. Mod/Digital Standard &gt; Clock Settings &gt; Local Connectors &gt; Signal &gt; Symbol Clock"</li> </ul> To enable the clock source: <ul style="list-style-type: none"> <li>"Custom. Dig. Mod/Digital Standard &gt; Clock Settings &gt; Clock Source &gt; Internal"</li> </ul>
Wideband (R&S SMW-B9)	T/M/C	Local connector on the coder board	Connector configuration is not required.  This signal is the default one, if "Custom. Dig. Mod > Data Source > Data Source > External Serial".

- **External clock reference**

Supply the external clock via the connectors listed in [Table 5-5](#).

**Table 5-5: Input connectors for the external reference clock signal**

Connector	Location	GUI selection
T/M/C	Local connector on each coder board	To configure the connector: <ul style="list-style-type: none"> <li>"Custom. Dig. Mod/Digital Standard &gt; Clock Settings &gt; Local Connectors &gt; Direction &gt; Input"</li> <li>"Custom. Dig. Mod/Digital Standard &gt; Clock Settings &gt; Local Connectors &gt; Signal &gt; Clock"</li> </ul> To enable the clock source: <ul style="list-style-type: none"> <li>"Custom. Dig. Mod/Digital Standard &gt; Clock Settings &gt; Clock Source &gt; External Local Clock"</li> </ul>



The signals provided at the global and local connector are configurable. However, there is a limitation on the number and the type of signals that are configured simultaneously, see [Section 12.2.2.5, "Internal resources for the trigger, marker, clock and control signals"](#), on page 747.

### Internal and external clock synchronization

When the external clock reference is selected, the internal clock is synchronized to it. Internally, the instrument interprets the rising edge as the active edge. The active edge of the external clock signal is configurable ("Local Connector Settings > Clock Input Slope"). The active rising edge of the internal clock is synchronized with either the rising or the falling edge of the external clock reference.



### Proper synchronization

The correct synchronization of the clock synthesizer requires that a special procedure is maintained. Refer to ["To apply an external clock signal"](#) on page 288 for a description of the required steps.

### Synchronizing data signals and clock signals

When selecting data signals and clock signals, the following modes are possible:

- External clock and internal data  
The modulation data is generated internally. The clock synchronization can be based on the rising edge or the falling edge according to the configuration. See also "[Internal modulation data](#)" on page 225.
- Internal clock and internal data  
The synchronization is always based on the positive edge of the clock.
- External or internal clock and external serial data  
The clock synchronization can be based on the rising or falling edge of the internal clock, and of the external symbol clock.  
From the externally supplied symbol clock, the instrument generates the bit clock. It uses the bit clock for reading the serial data. The active edge of the bit clock is configurable.  
See also "[External modulation data](#)" on page 226.  
If the internal clock is used, always connect the R&S SMW200A and the instrument acting as a data source to a common reference frequency.

Related settings:

- [Section 5.5.2.3, "Clock settings"](#), on page 259
- [Section 12.2, "Configuring local and global connectors"](#), on page 742
- Clock settings in the dialogs of the firmware options

For more information, refer to the specifications document.

#### 5.5.1.3 About control signals

The following control signals are processed in the R&S SMW200A:

- "Burst Gate" for power ramping
- "Level Attenuation" for power ramping
- "CW/Mod" for controlling the CW (continuous wave) mode

A dedicated internal "Control Data Editor" is provided for defining the control signals. Refer to [Section 5.6.3.8, "Control and marker lists editor"](#), on page 284 for a description on the provided settings.

#### Continuous wave mode

The "CW" signal turns off digital modulation. The signal is output in unmodulated form.

The CW/Mod control signal is generated internally and is output at one of the T/M connectors.

#### Power ramping and level attenuation

The R&S SMW200A uses the two control signals "Burst Gate" and "Lev\_Att" to trigger the power ramping and level attenuation functions.

The instrument internally generates control signals as configured in [Section 5.6.3.8, "Control and marker lists editor"](#), on page 284; the signals can be output on the T/M connectors.

- *Burst gate control signal*  
The "Burst Gate" signal is a rectangular pulse signal with variable low and high periods. Signal generation is restricted to the gate high periods. If the power ramping function is enabled, each transition between two gate periods of the "Burst Gate" signal triggers the generation of a ramp. Further settings define the form and the steepness of this ramp, see ["Impact of the power ramping settings on the generated signal"](#) on page 230.
- *Level attenuation control signal*  
The "Lev\_Att" signal is a rectangular pulse signal with variable low and high periods. Level attenuation is applied, if the "Lev\_Att" signal is high. If level attenuation is enabled, the modulation signal level is attenuated by a defined value.

Related settings:

- [Section 5.6.3.6, "Power ramp control settings"](#), on page 280



#### Possible applications

- Use the "Level Attenuation" function to simulate radio stations located at various distances.
- Use the "Power Ramp" function if it is necessary to control the RF output signal envelope synchronously, e.g. by the generation of TDMA signals.

Both the GSM/EDGE and the TD-SCDMA firmware options are equipped with embedded power ramping function. In the GSM/EDGE standard for example, a maximum of 7 different level attenuation values can be defined and allocated separately to the 8 slots independently of one another.

#### Impact of the power ramping settings on the generated signal

The [Figure 5-3](#) explains the power ramping function in principle. The "Burst Gate" signal defines the start of the rising and falling edges of the envelope of the output signal, and the "Lev Att" signal defines the start and end of level attenuation. The signal level during the attenuation period is a configurable value.

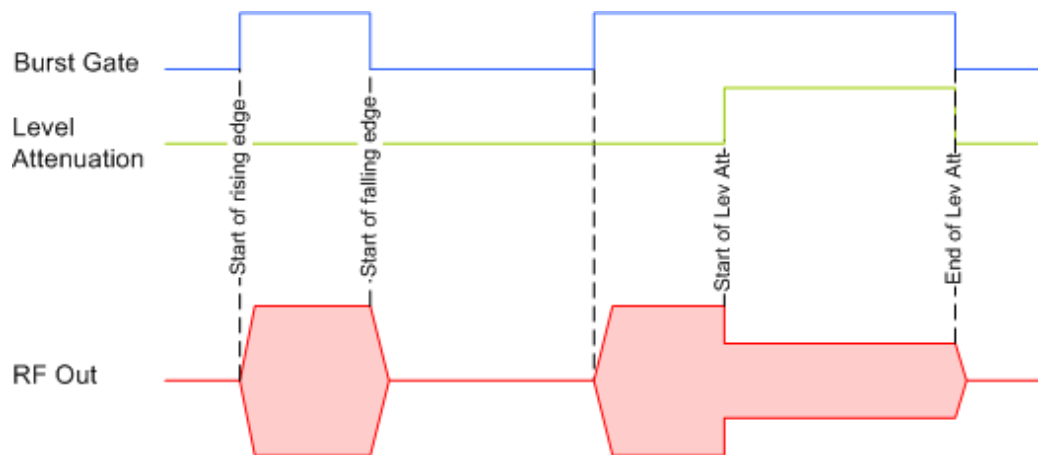

Figure 5-3: Signal behavior when power ramping and level attenuation are enabled

Several parameters are provided for precise definition of the form and the steepness of ramp. The Figure 5-4 depicts the impact of the provided settings.

- Ramp function: defines the shape of the rising and falling edges
- Ramp time: defines the duration of the rising and the falling ramp
- Rise/fall delay: offsets the falling edge of the envelope at the beginning/end of a burst

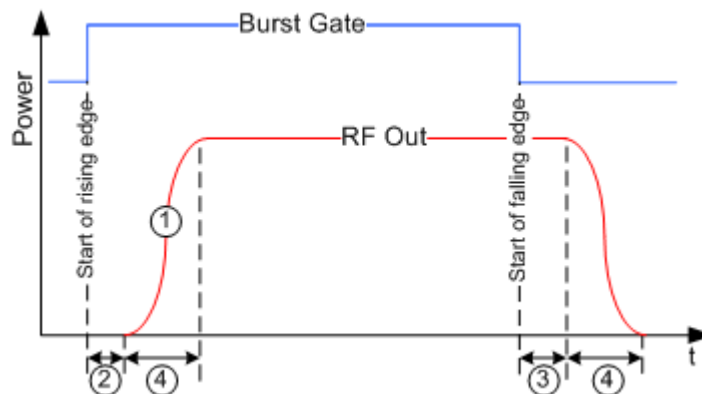

Figure 5-4: Impact of the ramp settings

- 1 = "Ramp Function"  
 2, 3 = "Rise Delay", "Fall Delay"  
 4 = "Ramp Time"

#### 5.5.1.4 About marker signals

The R&S SMW200A can add additional signals to the generated signal. Marker signals (or markers) are digital signals to synchronize external devices to the generated data stream. For example, with suitable marker settings, you can select a slot clock or frame clock, or mark the start of a particular modulation symbol.

### Number of marker signals and marker output

Three marker output signals are available in each baseband. All marker signals can be output at the provided connectors but not always at the same time (see [Section 12.2.2.5, "Internal resources for the trigger, marker, clock and control signals"](#), on page 747). The mapping of the marker output signal to the output connector is configurable.

**Table 5-6: Mapping of the marker signals to the output connectors**

Baseband generator	Baseband	Marker	Connector type	Connector name	Connector direction
Standard (R&S SMW-B10)	Baseband A/B/C/D	Marker 1, 2 and 3	Local connector	T/M	Output
			Global connectors	USER x	Output
Wideband (R&S SMW-B9)	Baseband A	Marker 1, 2	Local connector	T/M1/2	Output
	Baseband B	Marker 1, 2	Local connector	T/M1/2	Output
	Baseband A/B	Marker 1, 2 and 3	Global connectors	USER x	Output

### Related settings

- [Section 5.5.2.2, "Marker settings"](#), on page 258
- [Section 12.2, "Configuring local and global connectors"](#), on page 742
- Marker settings in the dialogs of the firmware options

### Marker modes

The marker mode is a characteristic for the shape and the periodicity of the marker. The R&S SMW200A provides several different modes to define different marker signals. Most of them are specific for each of the firmware options. This section focuses only on the general marker signals.

The marker mode is a characteristic for the shape and the periodicity of the marker. The R&S SMW200A provides several different modes to define different marker signals that are described in the following sections.

Generally, the marker signal can change from "On" (high) to "Off" (low) state or vice versa after some period of time. The instrument provides various ways to describe the marker signal. Use the method that best suits your needs.

### Marker mode restart

The generated marker signal is a single "On" pulse. The rising edge of this pulse is generated at the signal generation start and at each subsequent signal restart time. This marker can be used to monitor the effects of the selected trigger, e.g. trigger causing restarts of the signal generation.



**Marker mode pulse**

Periodic marker with consecutive on periods and off periods of equal length. The first on period starts at the beginning of the first generated sample/symbol. The marker frequency is defined by a "Divider". The frequency is derived as follows:

<Frequency> = "Symbol Rate"/"Sample Rate" / "Divider", respectively.

<Frequency> = "Sampling Frequency" / "Divider".

**Example:**

"Symbol Rate" = "1 Msym/s", "Divider" = "2"

The marker frequency is 500 kHz, corresponding to a marker period of 2 us. Each on and off period has a length of 1 us, corresponding to one symbol period. With a divider of 4 (6, 8 ...), the length of each on and off period is increased to 2 (3, 4, ...) symbol periods.

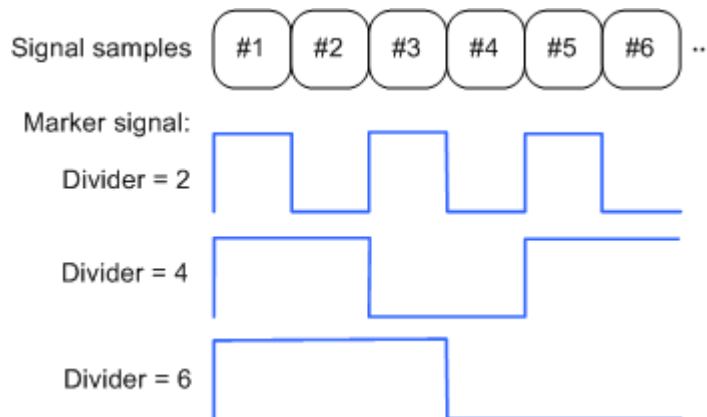
**Marker mode pattern**

Periodic marker where each period is defined by a bit pattern with a maximum length of 64 bits. A "1" ("0") in the pattern denotes an on (off) signal segment with a duration of one sample/symbol period.

**Example:**

In the following example, the marker signal is defined by a pattern 100100....

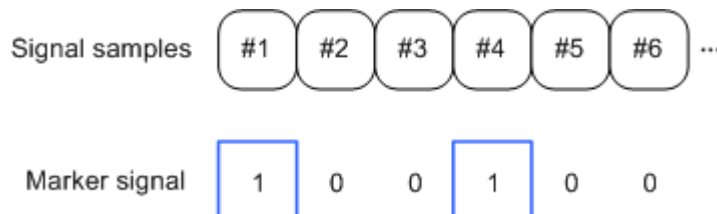
**Marker mode On/Off Ratio**

Similar to "Pulse" but with independent lengths of the on periods and off periods. The length of the periods is entered as several symbols/sample periods.

**Example:**

In the following example, the marker signal is defined by an "On Time" = "1 sym" and "Off Time" = "2 sym".

**Marker mode CList**

The instrument generates a marker signal that is defined in the selected control list. The R&S SMW200A provides a graphical interface for convenient definition of control signals among others also for the marker signals.

**Marker minimum duration**

The period length of several marker signals is specified as several symbols/sample, in one of the two ways: directly or as a mathematical function, where the marker period length is derived from other marker parameters. (See "[Marker modes](#)" on page 232)

Irrespectively of the way it is defined, if the [Wideband baseband](#) is used, the duration of the shortest marker period length is a value that depends on used sample or symbol rate. The possible sample or symbol rates in turn depend on the installed options, see [Table 5-7](#).

**Table 5-7: Minimum marker duration at the T/M connectors, depending on the System Config > Mode**

Sample rate or symbol rate	Minimum marker duration, Samples/symbols "System Config > Mode = Standard"	Minimum marker duration, Samples/symbols "System Config > Mode = Advanced"	Required options
≤ 400 MHz	1	1	R&S SMW-B9
> 400 MHz	8	1	R&S SMW-B9 and R&S SMW-K527

**Table 5-8: Minimum marker duration at the USER x connectors, depending on the System Config > Mode**

Sample rate or symbol rate	Minimum marker duration, Samples/symbols "System Config > Mode = Standard"	Minimum marker duration, Samples/symbols "System Config > Mode = Advanced"	Required options
≤ 300 MHz	1	1	R&S SMW-B9
300 MHz to 600 MHz	2	1	R&S SMW-B9
600 MHz to 1200 MHz	4	1	R&S SMW-B9 and R&S SMW-K527
1200 MHz to 2400 MHz	8	1	R&S SMW-B9 and R&S SMW-K527

The dependencies in [Table 5-7](#) apply to the following marker modes and in all firmware options:

- "Pattern"
- "On/Off Ratio"
- "Pulse"
- "Period"
- "User Defined"

### Delaying marker signals

In all the examples listed in ["Marker modes"](#) on page 232, the marker starts at the beginning of the first generated sample/symbol (sample/symbol no. 1). It is possible though to delay the start of the marker by an integer number of symbol periods or sample periods.

#### 5.5.1.5 About trigger signals

The R&S SMW200A provides several trigger modes, different trigger sources, and some additional trigger settings to suppress or delay the trigger events. This section provides an overview of the provided baseband trigger settings and the impact of the trigger settings on the signal generation.

The current signal generation status ("Running" or "Stopped") is continuously displayed in the corresponding dialog, indicated in the header of the tab and in the block diagram of the instrument. This indication is important when an external trigger is applied.

For information on the trigger signals used in the RF domain, see [Section 8.10.1, "Signal generation and triggering in the sweep and list modes"](#), on page 511.

### Trigger

The trigger signals are internally generated or externally supplied signals which start signal generation at a particular point in time. However, signal generation can also take place without triggering. In this case, the signal generation starts immediately after the modulation is enabled.

### Trigger event

A trigger event is caused by the received trigger signal. Another possibility to provoke a trigger event is to execute the trigger manually. The "Arm" function stops the signal generation until a following trigger event occurs.

- [Trigger sources](#)..... 236
- [About trigger modes](#).....237
- [Impact of additional trigger settings](#)..... 240
- [Receiving and providing trigger signals](#)..... 243

### Trigger sources

The provided trigger sources are divided into two main groups, internally generated or externally supplied trigger signals.

- Internal ("Internal" and "Internal Baseband A/B")  
Internal trigger signals are generated by the instrument itself and can be used independently per baseband or routed from one to the other. This feature is useful, if the signal generation start in the basebands has to be synchronized.
- External ("External Global Trigger 1/2", "External Local Trigger", "External Local Clock")  
External trigger signal is generated by an external trigger source.
  - An external *local* trigger/clock signal is dedicated to the baseband board this signal is supplied at.  
(That is, the board the local T/M/C connector is located at).  
An external *local* trigger/clock signal can be internally routed and used for synchronous triggering of all other basebands.
  - An external *global* trigger signal can be supplied to one or simultaneously to all the basebands. The latter possibility is the useful, if common triggering of all basebands and synchronous generation start are required.

The instrument expects the trigger signal at one of the T/M/C or USER x connectors. Refer to [Section 12.2, "Configuring local and global connectors"](#), on page 742 for information on how to configure the required settings; see also [Figure 12-1](#).

- External ("Baseband Sync In")  
Option: R&S SMW-B9  
In primary-secondary instrument mode, secondary instruments are triggered by the active edge of the synchronization signal.  
This trigger source is selected automatically and cannot be changed.  
See [Section 10.3.1, "Connecting multiple instruments in primary-secondary instrument mode"](#), on page 664.



The trigger mode setting, the selection of the trigger source and the setting of a delay and trigger suppression in the case of external triggering are carried out independently for each of the basebands or, if there is coupled trigger settings, jointly for all basebands.

However, the polarity and impedance characteristics of the external signals supplied at the USER connectors are identical for all basebands using this signal.

A signal which marks the trigger event can be output at the T/M/C connectors.

Related settings:

- [Section 5.5.2.1, "Trigger settings"](#), on page 252
- [Section 12.2, "Configuring local and global connectors"](#), on page 742
- Trigger settings in the dialogs of the firmware options

### About trigger modes

A trigger event defines the signal generation and depends on the trigger mode. The [Table 5-9](#) provides an overview of the trigger modes and their impact on the signal generation start.

**Table 5-9: Impact of the trigger events on the generated signal**

"Trigger Mode"	Signal generation mode <sup>1)</sup>	1st Trigger event "Exec. Trigger" or "External" trigger signal	Subsequent trigger event "Exec. Trigger" or "External" trigger signal	Trigger event "Arm"
"Auto" See <a href="#">Figure 5-6</a>	Continuous	-	-	-
"Retrigger" See <a href="#">Figure 5-7</a>	Continuous	Initial start	Restart	-
"Armed_auto" See <a href="#">Figure 5-8</a>	Continuous	Initial start	Restart (only after previous "Arm")	Stop
"Armed_retrigger" See <a href="#">Figure 5-9</a>	Continuous	Initial start	Restart	Stop
"Single" See <a href="#">Figure 5-5</a>	Single length determined by "Trigger Signal Duration"	Initial start	Restart	-

<sup>1)</sup> the instrument generates a continuous signal or a single signal.

- Single signal generation means that the signal generation stops after one cycle. That is, after the signal with signal length determined by the "Trigger Signal Duration" has been generated.
- Continuous transmission means that the signal is generated repeatedly without delay and until the data generation is stopped explicitly. However, any parameter change within the processing chain (baseband, fading simulator, or stream mapping) causes a signal generation restart.

The following is a list of the trigger modes together with their short description. An example of their impact on the generated signal is given. The provided examples are intended to show the triggering mechanism in principle. To simplify the description, an internal trigger event ("Execute Trigger") is used. An external trigger event has the same effect on the signal generation. In the examples on the figures below, the instrument's processing time is ignored.

- Single  
The instrument starts the signal generation only when a trigger event occurs. The signal is generated once. Its signal length is set with the parameter "Trigger Signal Duration".  
Every subsequent trigger event causes a restart.

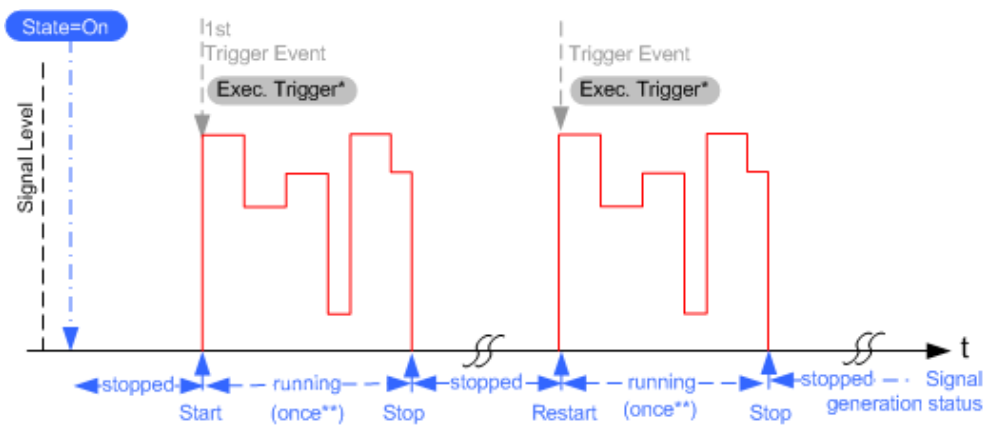

Figure 5-5: Trigger mode single

\* = Internal trigger event (to simplify the description)

\*\* = The signal is generated once to the length specified with "Trigger Signal Duration"

- Auto

In auto trigger mode, the instrument generates a continuous signal.

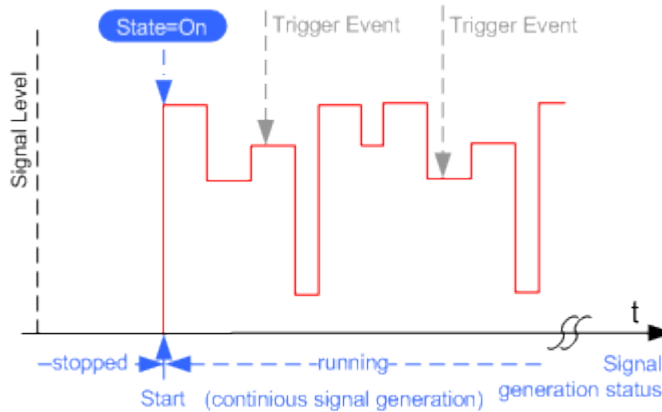
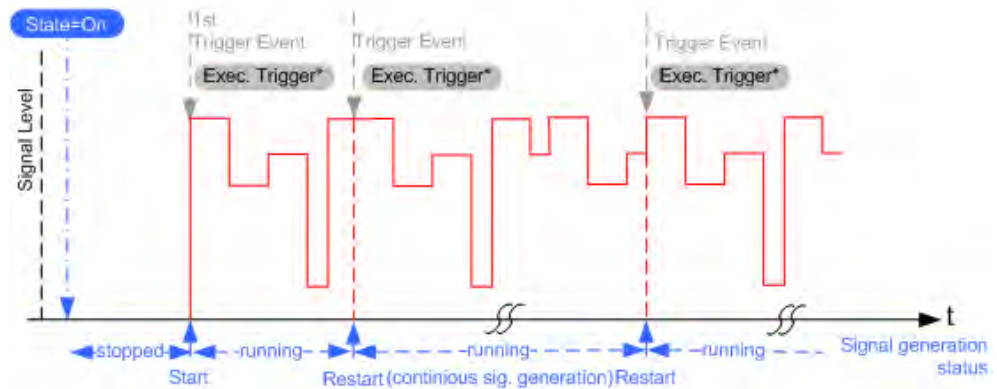

Figure 5-6: Trigger mode auto

- Retrigger

The instrument generates a continuous signal. With enabled retrigger, a new trigger event aborts the current generation cycle and restarts the signal generation from the beginning.



**Figure 5-7: Trigger mode retrigger**

\* = Internal trigger event (to simplify the description)

Compare the shape and the length of the red curve in single mode and in retrigger mode. The first part of the curve in retrigger mode is shorter. The signal generation is interrupted due to the subsequent trigger event.

- **Armed auto**

The instrument starts the signal generation only when a trigger event occurs and then generates a continuous signal. An "Arm" stops signal generation. A subsequent trigger event causes a restart of the signal generation.

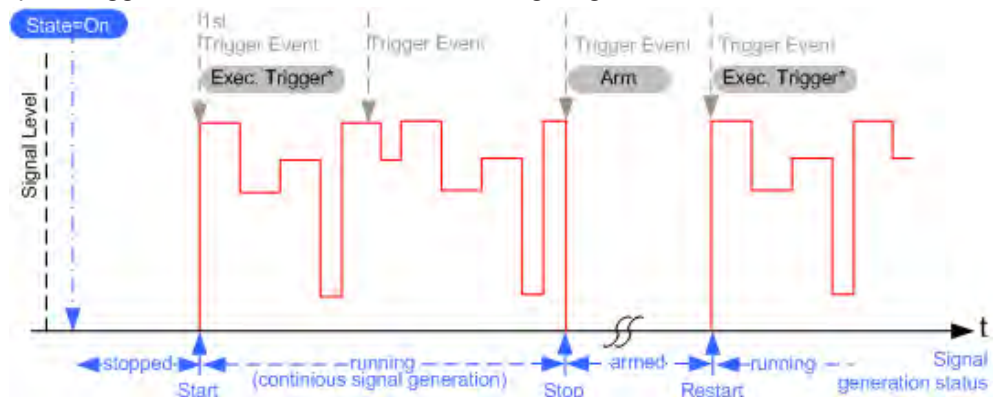

**Figure 5-8: Trigger mode armed auto**

\* = Internal trigger event (to simplify the description)

- **Armed retrigger**

The instrument starts the signal generation only when a trigger event occurs and then generates a continuous signal. Every subsequent trigger event causes a restart of the signal generation.

An "Arm" stops the signal generation. A subsequent trigger event causes a restart.

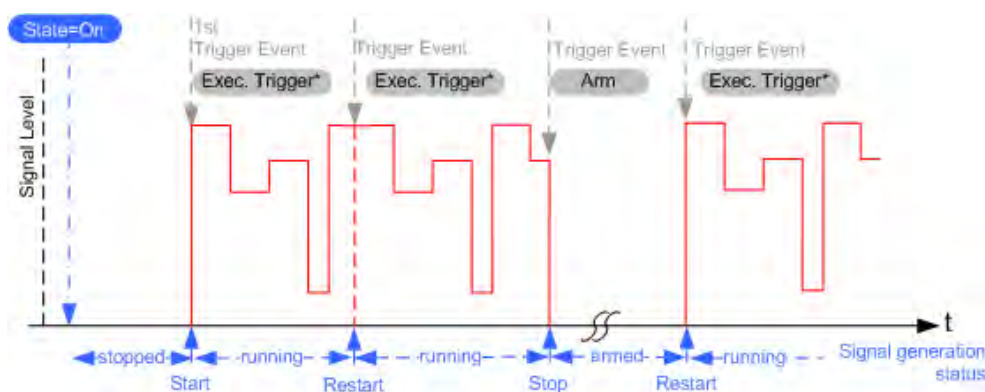

Figure 5-9: Trigger mode armed retrigger

\* = Internal trigger event (to simplify the description)

### Impact of additional trigger settings

The R&S SMW200A provides a set of settings to configure the behavior upon receiving of a trigger signal. For example:

- Suppressing trigger events
- Delaying the instrument's response on trigger events
- Adjusting the signal calculation start time in relation to the trigger event.

### Avoiding accidental trigger events

The following trigger settings enhance the flexibility of the trigger system and can help to avoid accidental trigger events.

- "Threshold Trigger Input"  
Defines the voltage level of the trigger signal where the R&S SMW200A generates a trigger event. Trigger signals below the trigger threshold are ignored.
- "Trigger Input Slope"  
Specifies the edge (rising or falling edge) of the trigger signal that is to provide the trigger event.
- "Impedance Trigger Input"  
Specifies the input impedance of the trigger signal.

### Starting the signal generation with the first sample

By default, the instrument starts the signal calculation simultaneously with the receiving of the external trigger event. Because of the signal propagation time and the instrument's processing time, the first samples are cut off and no signal is output.

This default behavior, however, can cause problems if short signal sequences are generated. To overcome this problem, the instrument provides the special parameter "Sync. Output to (External) Trigger". If this parameter is disabled, the signal output begins after elapsing of the processing time and starts with sample 0. That is, the complete signal is output (compare both figures in [Table 5-10](#)).

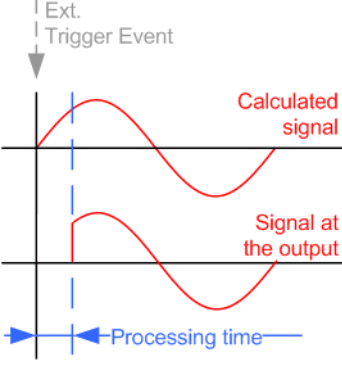
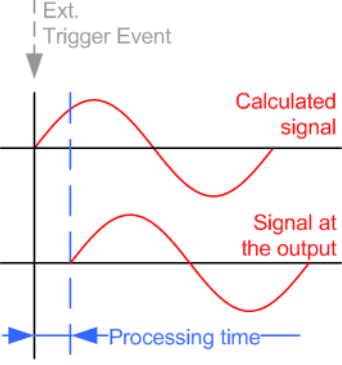

Table 5-10: Impact of the parameter Sync. Output to (External) Trigger

"Sync. Output to (External) Trigger = On"	"Sync. Output to (External) Trigger = Off"
 <p data-bbox="403 745 906 999">           Suitable for long signal sequences            The output signal is synchronous to the trigger event after elapsing of the internal processing time.            In primary-secondary instrument mode, this setting ensures that once achieved, synchronization is not lost if the baseband signal sample rate changes.            See also <a href="#">Section 10.3.1.2, "Connecting and configuring primary-secondary instruments"</a>, on page 667.         </p>	 <p data-bbox="924 745 1426 999">           Suitable for triggering of short signal sequences with signal duration comparable with the processing time of the instrument         </p>

### Suppressing and delaying trigger events

The main focus of the following features is the mobile communication standards.

- "(External) Trigger Delay"
 

You can apply a definable number of symbols to delay the **start** trigger event of an externally supplied or routed from the other path trigger signals

This feature is useful to:

  - Simulate the time delay between a base station signal and a user equipment signal, for example during base station tests
  - Compensate for known propagation delays or a timing offset in the test setups
  - Enable a time delay between the generated baseband signals
- "(External) Trigger Inhibit"
 

You can suppress the effect of a restarted trigger signal in the "Retrigger" trigger mode for a definable number of symbols.

During base station tests, for example, this feature enables the trigger suppression for a definable number of frames and yet the signal can still be generated synchronously. In each frame, the base station generates a trigger event that restarts the signal generation every time but for the suppression.

#### Example:

A trigger delay of 1000 samples means that after a trigger event, any subsequent trigger signal is ignored for the space of 1000 samples.

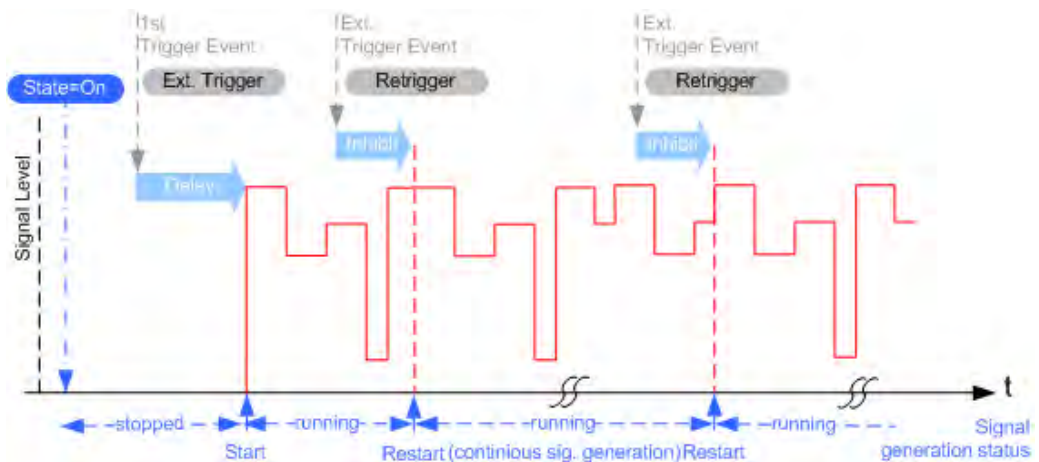

Figure 5-10: Trigger delay and trigger inhibit in trigger mode retrigger

### To set delay and inhibit values

Trigger delay and inhibit values are expressed in the units of the generated signal, e.g. in samples or symbols. You can also define the exact delay or inhibit period as a time value, e.g. in seconds.

Trigger delay values  $t_{\text{delay}}$  depend on the instrument hardware. The table illustrates an exemplary instrument configuration and related  $t_{\text{delay}}$  values in samples (or symbols) and in seconds.

Option	Max. $r_s$ / MHz	$t_{\text{delay}}$ / samples	$t_{\text{delay}}$ / s
R&S SMW-B10	200	0 to 2147483647	0 to depends on sample rate

For more information, refer to the specifications document.

### Example: ARB clock frequency and trigger delay

This example describes an ARB signal with 1 MHz clock frequency. It illustrates the relation between the ARB clock frequency and the configurable trigger delay.

The relation applies for any external triggering and triggering via the other signal paths.

1. Select "Baseband" > "ARB" > "Clock Frequency" = "1 MHz".
2. Configure an external, for example, for an armed auto trigger mode.
  - a) Select "ARB" > "Trigger In" > "Mode" > "Armed Auto"
  - b) Select "Source" > "External Global Trigger 1".
  - c) Select "External Delay Unit" > "Samples".
  - d) Set "External Delay" = "100 Samples".

The parameter "Actual External Delay" = "100 us" displays the actual delay in time units.

External Delay Unit	Sample	Processing Time	—
External Delay	100.00 Samples	Actual External Delay	100.000 0 µs

3. Set the delay in time units.

- a) Select "External Delay Unit" > "Time".
- b) Select "Specified External Delay" > "10 µs".

The "Actual External Delay" changes to 10 us.

External Delay Unit	Time	Processing Time	—
Specified External Delay	100.000 0 µs	Actual External Delay	100.000 0 µs

4. To check again the delay in samples, select "External Delay Unit" > "Samples".

The external delay and actual delay is 10 samples.

External Delay Unit	Sample	Processing Time	—
External Delay	10.00 Samples	Actual External Delay	10.000 0 µs

### Receiving and providing trigger signals

In test setups that combine the signal of two or more instruments and/or basebands it is often required that:

- The signal generation starts at a defined moment
- The signal generation starts simultaneously (or with an exactly defined delay) in:
  - All involved instruments
  - All basebands of the same R&S SMW200A

The generation of simultaneous baseband signals within the same instrument requires a common trigger event to define the signal generation start. This section explains how the R&S SMW200A supports you to achieve this requirement.

For information on simultaneous signal generation start in multiple instruments, see [Section 10.3, "Generating time-aligned baseband signals"](#), on page 664.

### Simultaneous signal generation start in all basebands

The R&S SMW200A supports you to trigger all basebands simultaneously in the following cases:

- In system configuration with [Coupled sources](#)  
See ["Coupled or separate baseband sources"](#) on page 107
- In a configuration that involves signal routing with signal addition, like:
  - Any [MIMO](#) configuration  
See [Section 4.2.2, "Using the system configuration capabilities"](#), on page 106
  - Routing and summing of [Baseband](#) or [Stream](#) signals before and after the "Fading" blocks  
See [Section 4.2.1, "Using the signal routing settings and the block diagram"](#), on page 105

- Routing and summing of **Streams** in the "I/Q Stream Mapper"  
See "[I/Q stream mapper](#)" on page 107
- In instruments equipped with 2xR&S SMW200A-B10, 1xR&S SMW200A-B14 and R&S SMW200A-B13T.
- In primary-secondary instrument mode  
See [Section 10.3.1, "Connecting multiple instruments in primary-secondary instrument mode"](#), on page 664.

To enable simultaneous signal generation in all basebands in any of these cases, the R&S SMW200A couples automatically the trigger settings in all available basebands. It is sufficient to adjust the trigger settings, like trigger source and trigger mode **in one of the basebands**; the R&S SMW200A applies them automatically to all other. An arm or a restart trigger event applies to all basebands, too. You can still apply different delay to each of the triggers individually.

### Example:

This example shows schematically the distribution of the trigger signal in an instrument with the following configuration:

- "System Configuration > Entity = 1", 4x4 MIMO configuration (1x4x4) and "Baseband Source Config > Separate".
- "Baseband A > ... > Trigger In > Trigger Source > Ext. Global Trigger 1"  
Each of the "Baseband B/C/D" adopts the same trigger source automatically.

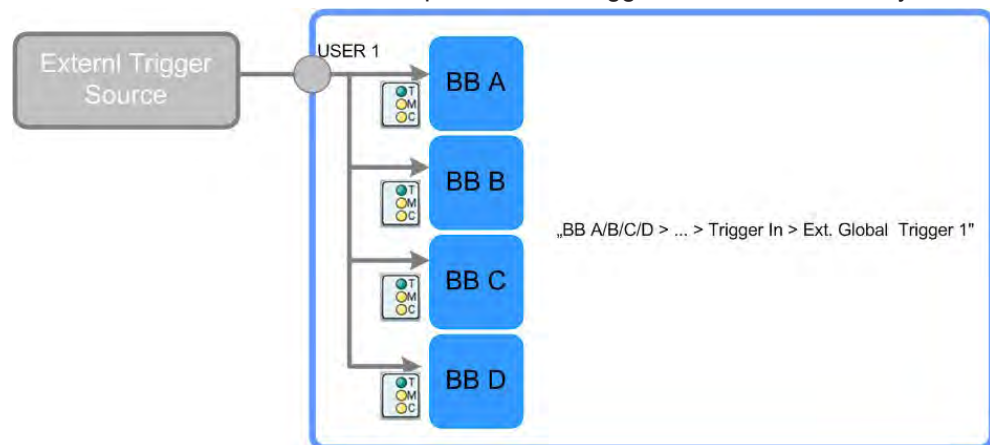

*Figure 5-11: Distribution of the external trigger signal in the coupled trigger settings mode*

- "Baseband A > ... > Trigger In > Trigger Mode > Retrigger"  
The "Baseband B/C/D" adopt the same trigger mode automatically.

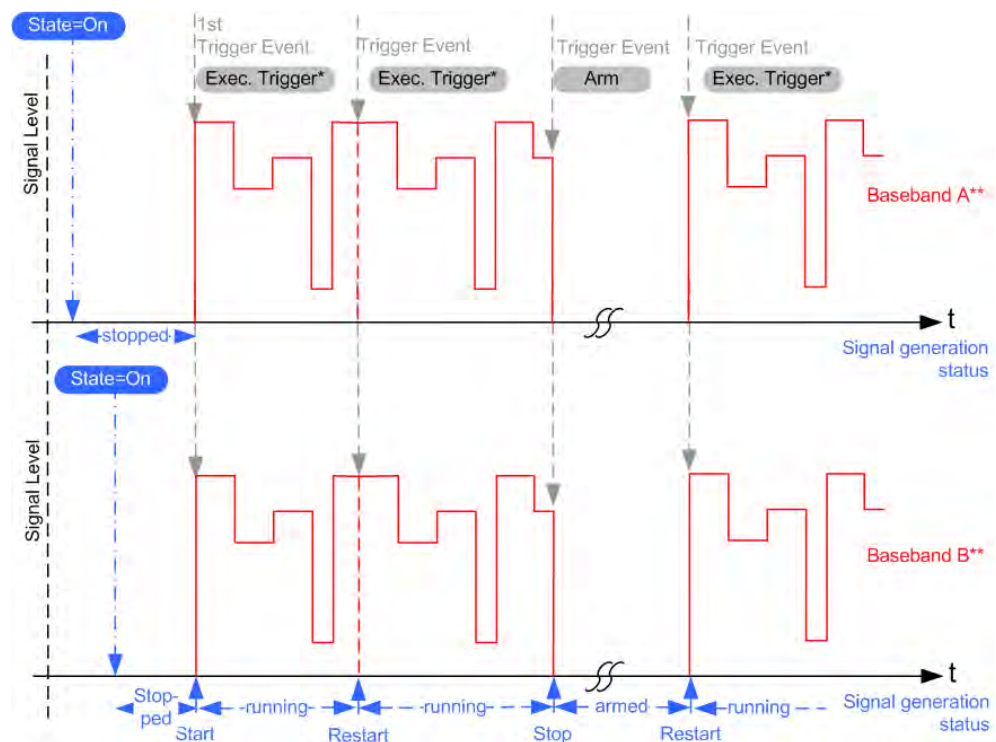

Figure 5-12: Simultaneous triggering of two basebands in coupled trigger settings mode

\*\* = This example assumes identical basebands and shows only the first two of them

The signal generation starts simultaneously in all basebands but you can still delay the basebands compared to each other.

Some test setups require the signal of two or more baseband sources but do not have a coupled trigger setting. In this case, trigger the baseband sources from a common trigger source. Use, for example, an external trigger source or to distribute the internal trigger signal of one of the basebands to the other.

For a step-by-step description, see [Section 5.5.3, "Triggering with a common signal"](#), on page 261.

### 5.5.1.6 Supported modulation signals

The R&S SMW200A supports a range of predefined digital and analog modulation signals. This section focuses on the possibility to digitally modulate the baseband signal.

The analog modulation methods provided for shifting the frequency bandwidth of the RF signal are described in [Section 8.11, "Analog modulations"](#), on page 546.

In communication techniques, commonly used digital modulation schemes are based on keying. From the several existing keying techniques, this instrument supports ASK (amplitude shift keying), FSK (frequency shift keying), PSK (phase shift keying), and QAM (quadrature amplitude modulation).

The digital modulation procedure is described by mapping. That is, by the assignment of I and Q values (PSK and QAM) or frequency shifts (FSK) to every modulation sym-

bol. The resulting modulated signal is graphically represented by a constellation diagram, in that each possible symbol is represented by a discrete point on a complex plane. The number of bits per symbol is a modulation parameter. The exact position of the symbols on the constellation diagram is determined by the used coding scheme. You can also change the symbol position by applying rotation.

Most of the provided modulation schemes are implemented according to a communication standard. The QAM procedures 16QAM, 32QAM, 64QAM, for instance, have been produced in accordance with ETSI standard ETS 300429 for digital video broadcasting (DVB). The QAM procedures 256QAM and 1024QAM are not specified in this standard, but have been produced according to the same basic principles.

For all FSK procedures, you can set the symbol rate  $f_{\text{SYMB}}$  up to a maximum value. The frequency deviation (FSK deviation) of the MSK modulation is permanently set to  $\frac{1}{4}$  of the symbol rate. Also a variable FSK modulation with definable deviation per symbol is available and for even greater flexibility. A user-defined modulation mapping can be applied, see ["User mapping"](#) on page 246.

For more information, refer to the specifications document.

### User mapping

A user-defined modulation-mapping file can also be selected as a modulation-mapping source. Valid files have the extension `*.vam` and can be created with the Rohde & Schwarz software tool-mapping wizard. The mapping wizard "mapwiz" is a tool from Rohde & Schwarz designed for editing modulation schemes (for example QPSK, 32QAM).

The main purpose of "mapwiz" is the assignment of logical symbol numbers to constellation points and the selection of modulation-specific parameters. Also, the tool supports the creation of nearly any arbitrarily chosen constellation diagram. The output of "mapwiz" is a mapping file (`*.vam`) that can be imported into a R&S SMW200A. The program was developed on a 32-bit Microsoft Windows platform under MATLAB.

For more information, see "Introduction to "mapwiz" Mapping Editor" at the Rohde & Schwarz webpage.

The remote commands required to define the modulation settings are described in [Section 14.19.5.2, "SOURCE:BB:DM subsystem"](#), on page 1060.

Related settings:

- [Section 5.6.3.4, "Modulation settings"](#), on page 276

#### 5.5.1.7 Supported coding schemes

Coding is a technique used to improve the signal properties and signal reception and is required only when using some types of modulation. In general, the coding schemes are applied before modulation. The modulation symbols are coded directly before I and Q values or frequency shifts are assigned. The applied coding is directly related to the selected modulation methods. The relation implies that coding schemes are not freely combinable with the modulation methods.

See section [Section 5.6.5.1, "Default settings and predefined configurations"](#), on page 292 for an overview on the available coding combinations. This section also defines the modulation formats for which the various coding procedures can be used.

Related settings:

- ["Coding"](#) on page 270

### 5.5.1.8 Supported baseband filters

In the wireless transmission technique, filters are applied to shape the baseband signal before it is modulated on the RF. The selected baseband filter type and shape affect the output stream, especially while generating broadband signals. If the filter is too narrow, it cuts the signal. If the filter is too wide, the signal could be distorted by some unwanted signals.

To fulfill wide range of requirements, the R&S SMW200A offers a wide selection of predefined baseband filters. The predefined filters are designed for the special spectrum characteristics of the different communication standards. However, depending on the selected filter form one or more filter parameters are provided for even more precise adjustment of the filter characteristic. You can select, for example, steeper edges or change the transition bandwidth. For more information on the provided settings, see ["Impact of the filter parameters"](#) on page 248.

The selection of user-defined filters offers even more flexibility. Use these filters if you need to filter with filters of complex or proprietary form are required. For more information, refer to ["User filter"](#) on page 247.

#### Predefined baseband filters

See [Section 5.6.5.3, "Predefined baseband filters"](#), on page 297 for an overview of available baseband filters.

#### User filter

The user filter file must have an extension `*.vaf` and can be created with the Rohde & Schwarz software tool filter wizard.

The filter wizard (filtwiz) is a tool from Rohde & Schwarz designed for creating filter files that can be imported on a R&S SMW200A. Its main purpose is the conversion of user-defined finite impulse response (FIR) filters into the filter format (`*.vaf`). Beyond this filt wiz provides designs for standard filters, e.g. root raised cosine (RRC), Gaussian.

The program was developed on a 32-bit Microsoft Windows platform under MATLAB.

For more information, see "Introduction to "filtwiz" Filter Editor" at the Rohde & Schwarz webpage.

The remote commands required to define the filter settings are described in [Section 14.19.5.2, "SOURCE:BB:DM subsystem"](#), on page 1060 and the corresponding section in the user manual of each firmware option.

Related settings:

- [Section 5.6.3.5, "Filter settings"](#), on page 278

- Filter settings in the dialogs of the firmware options

### Impact of the filter parameters

The following is a simple description of the filter parameters and the way they affect the main filter characteristics. Changing filter parameters is an effective way to ensure that the entire bandwidth of the desired signal is allowed to pass and adjust the filter form to reach the spectrum mask requirements.

### Cut Off Frequency

The cut-off frequency or corner frequency is a filter characteristic that defines the frequency at the 3 dB down point. This frequency is bound to the transition band; here the filter characteristic changes form the passband to the stopband, where the signal is suppressed.

### Rolloff Factor

The rolloff factor is a measure for the excess bandwidth compared to the ideal bandwidth of a "brick like" filter. The roll off factor affects the steepness of the filter flanks. A "Rolloff Factor" = 0 would result in the steepest theoretically possible flanks ; values near to 1 make the flanks more flat.

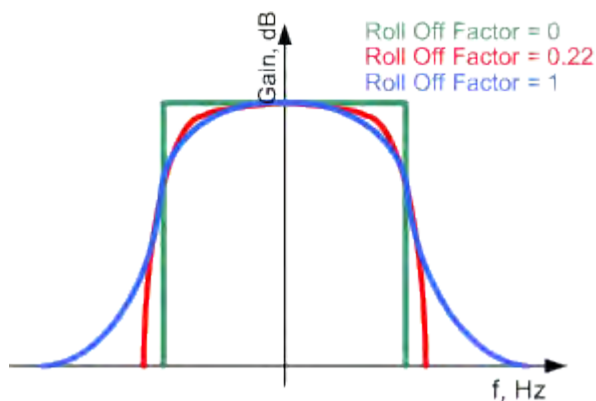

### Passband

The passband describes the frequency span that the filter passes unchanged. The total passband of a filter is given as follows:

$$\text{Bandwidth} = (1 + \text{"Roll Off Factor"}) * \text{"Symbol Rate"}$$

### Cut Off Frequency Shift

The "Cut Off Frequency Shift" affects the cut-off frequency in the way that the filter flanks are "moved" and the passband increases by "Cut Off Frequency Shift"\*"Sample Rate":

$$\text{Cut Off Frequency} = (1 + \text{"Cut Off Frequency Shift"}) * \text{"Sample Rate"}$$



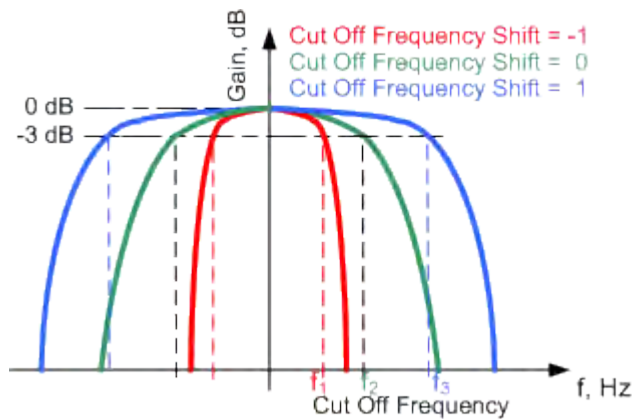

- A "Cut Off Frequency Shift" = -1 results in a very narrow-band filter
- Increasing the value up to 1 makes the filter more broad-band
- By "Cut Off Frequency Shift" = 0, the -3 dB point is at the frequency determined by the half of the selected "Sample Rate".

#### 5.5.1.9 Methods for optimizing the crest factor

Communication standards utilizing higher-order modulation techniques or using multiple carriers and complex signals consisting of the signals of more than one digital standard can feature a high crest factor. The signals of some digital standards can have high crest factors also particularly with many channels and long sequences.

##### About the crest factor

The crest factor represents the ratio of the peak voltage value to the RMS voltage value, i.e. the peak to average ratio (PAR). The higher the crest factor and the resulting dynamics of a signal, the greater the requirement for a power amplifier fed by the signal to be linear.

A high crest factor arises, for example, when in a multicarrier signal the carriers feature an identical start phase. Multicarrier signals imply periodically superimposed signals with high peak voltages in relation to the RMS voltage values.

High crest factors entail two basic problems:

- The nonlinearity of the power amplifier (compression) causes intermodulation which expands the spectrum (spectral regrowth).
- Since the level of the D/A converter is relative to the maximum value, the average value is converted with a relatively low resolution. This low resolution leads to a high quantization noise.

Both effects increase the adjacent-channel power.

##### Direct crest factor reduction

At the individual signal generation stages, the R&S SMW200A offers different direct approaches to reduce the crest factor. While the corresponding parameters are enabled, the implemented algorithms ensure minimizing the crest factor or achieving of predefined target crest factor by applying of automatic settings. Methods of reducing

the crest factor differ regarding both the optimization achievable and the time required for computation.

The provided crest factor reduction methods include:

- Internal calculation of optimized carrier phases for the individual carriers in a multi-carrier signal
- Automatic calculation of the carrier start phases in a multi-carrier continuous wave signal

### Applying clipping and filtering

Another common and simple approach for achieving a lower PAR is the combination of clipping and filtering. In several of the firmware options, like 3GPP FDD or CDMA2000, the instrument provides baseband clipping. Also, you can select the baseband filter and adjust the filter characteristics.

- Clipping is a method that applies a wanted distortion to the signal, see [Example "Vector clipping and crest factor"](#) on page 250. This method includes specifying a level limit, finding out the signal peaks and clipping off the peaks that exceed the limit. The level limit is a percentage of the highest peak value. Clipping does not influence the spectrum but the error vector magnitude (EVM) increases.

The instrument offers two clipping modes:

- Vector clipping:  $|I + q|$

The clipping limit is related to the amplitude  $|I + q|$ . This mode maps the I and Q components together and retains the angle between the vectors.

- Scalar clipping  $|I| + |q|$

The clipping limit is related to the absolute maximum of all the I and Q values  $|I| + |q|$ . This mode maps the I and Q components separately, the angle changes between the vectors.

Signal clipping not only changes the peak value but also the average value and the effect on the crest factor is unpredictable.

- Filtering is a method after clipping. The filters are able to filter out the distortion.

### Example: Vector clipping and crest factor

The following figures display constellation diagrams that demonstrate the effect of the clipping on the crest factor for typical scenarios.

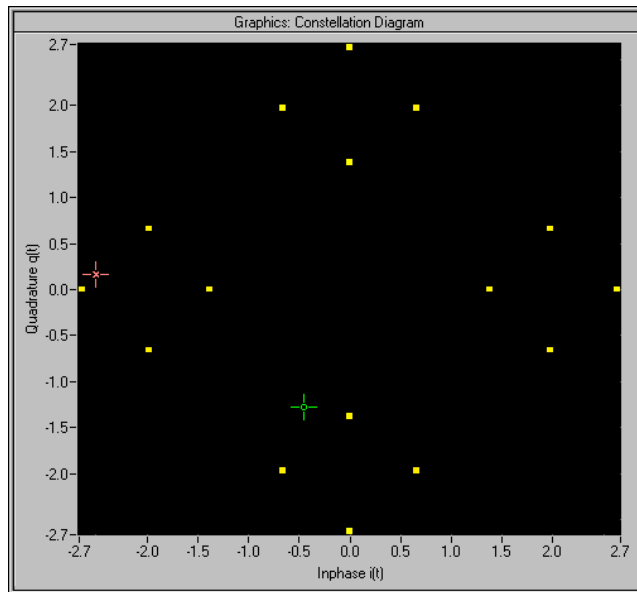

Figure 5-13: I/Q constellation without clipping

The clipping mode in figure Figure 5-14 is vector  $|I + q|$  mode and the I/Q signal configuration has two active channels. The circle visualizes the changed constellation points.

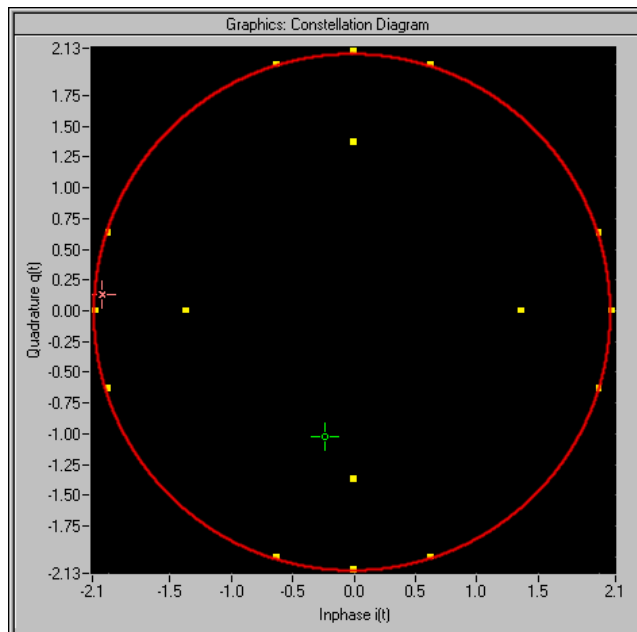

Figure 5-14: I/Q constellation with vector clipping and clipping level 80 %

## 5.5.2 Common baseband settings

The main baseband dialog for a digital standard follows a repeating dialog structure including the tabs "General", "Trigger In", "Marker" and "Clock".

The "General" tab comprises the primary settings of the standard, the functions for storing and recalling settings. It also provides access to further functions and dialogs, like the "Filter" settings.

The "Trigger In", "Marker" and "Clock" tabs comprise the settings related to the corresponding function.

In the following, we use the "Custom Digital Mod" dialog to explain the provided common settings. The related remote control commands are listed in the order "Custom Digital Mod", "ARB", "Multi Carrier CW".

### About trigger marker clock signals

For background information on these signals, see the following sections:

- [Section 5.5.1.5, "About trigger signals"](#), on page 235
- [Section 5.5.1.4, "About marker signals"](#), on page 231
- [Section 5.5.1.2, "About clock signals"](#), on page 227

#### Settings:

- [Trigger settings](#)..... 252
- [Marker settings](#)..... 258
- [Clock settings](#)..... 259
- [Local and global connectors settings](#)..... 261

### 5.5.2.1 Trigger settings

Access:

- ▶ Select "Baseband" > "Custom Digital Mod" > "Trigger In".

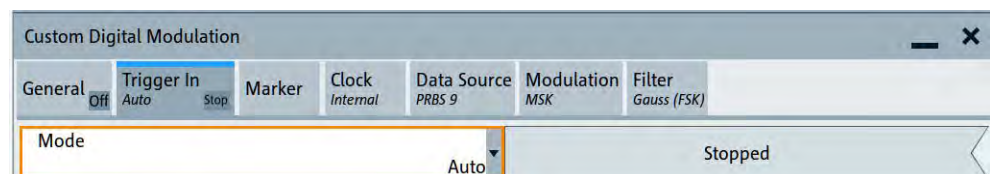

This tab provides settings to select and configure the trigger, like trigger source, trigger mode and trigger delays, and to arm or trigger an internal trigger manually. The header of the tab displays the status of the trigger signal and trigger mode. As in the tabs "Marker" and "Clock", this tab also provides access to the settings of the related connectors.

#### Routing and activating a trigger signal

1. Define the effect of a trigger event and the trigger signal source.
  - a) Select "Trigger In" > "Mode".
  - b) Select "Trigger In" > "Source".
2. For external trigger signals, define the connector for signal input. See [Section 5.5.2.4, "Local and global connectors settings"](#), on page 261.

You can map trigger signals to one or more USER x or T/M connectors.

Local and global connectors settings allow you to configure the signal mapping, the polarity, the trigger threshold and the input impedance of the input connectors.

3. Activate baseband signal generation. In the block diagram, set "Baseband" > "On".  
The R&S SMW200A starts baseband signal generation after the configured trigger event.

### About baseband trigger signals

This section focuses on the available settings.

For detailed information, see [Section 5.5.1, "About common baseband characteristics"](#), on page 224.

#### Settings:

<a href="#">Trigger settings common to all basebands</a> .....	253
<a href="#">Mode</a> .....	253
<a href="#">Running/Stopped</a> .....	254
<a href="#">Time Based Trigger</a> .....	254
<a href="#">Trigger Time</a> .....	254
<a href="#">Arm</a> .....	255
<a href="#">Execute Trigger</a> .....	255
<a href="#">Source</a> .....	255
<a href="#">Sync. Output to Ext. Trigger/Sync. Output to Trigger</a> .....	256
<a href="#">External Inhibit/Trigger Inhibit</a> .....	256
<a href="#">(External) Delay Unit</a> .....	256
<a href="#">(Specified) External Delay/(Specified) Trigger Delay</a> .....	257
<a href="#">Actual Trigger Delay/Actual External Delay</a> .....	257
<a href="#">Signal Duration</a> .....	257

### Trigger settings common to all basebands

To enable simultaneous signal generation in all basebands, the R&S SMW200A couples the trigger settings in the available basebands in any instrument's configuration involving signal routing with signal addition. For example, in MIMO configuration, routing and summing of basebands or of streams.

The icon  indicates that common trigger settings are applied.

You can access and configure the common trigger source and trigger mode settings in any of the basebands. An arm or a restart trigger event applies to all basebands, too. You can still apply different delay to each of the triggers individually.

#### Mode

Selects the trigger mode. The mode determines the effect of a trigger event on the signal generation.

See also ["About trigger modes"](#) on page 237.

Remote command:

[\[:SOURce<hw>\]:BB:DM\[:TRIGger\]:SEQuence](#) on page 1077

[\[:SOURce<hw>\]:BB:ARBitrary\[:TRIGger\]:SEQuence](#) on page 1138

[\[:SOURce<hw>\]:BB:MCCW\[:TRIGger\]:SEQuence](#) on page 1161

### Running/Stopped

With enabled modulation, displays the status of signal generation for all trigger modes.

- "Running"  
The signal is generated; a trigger was (internally or externally) initiated in triggered mode.
- "Stopped"  
The signal is not generated and the instrument waits for a trigger event.

Remote command:

[\[:SOURce<hw>\]:BB:DM:TRIGger:RMODe?](#) on page 1078

[\[:SOURce<hw>\]:BB:ARBitrary:TRIGger:RMODe?](#) on page 1139

[\[:SOURce<hw>\]:BB:MCCW:TRIGger:RMODe?](#) on page 1162

### Time Based Trigger

Requires trigger "Mode" > "Armed Auto"/"Single".

Activates time-based triggering with a fixed time reference.

The R&S SMW200A triggers signal generation when its operating system time ("Current Time") matches a specified time trigger ("Trigger Time"). As trigger source, you can use an internal trigger or an external global trigger.

How to: [Section 5.5.4, "Time-based triggering"](#), on page 263

Remote command:

[\[:SOURce<hw>\]:BB:DM:TRIGger:TIME\[:STATe\]](#) on page 1079

[\[:SOURce<hw>\]:BB:ARBitrary:TRIGger:TIME\[:STATe\]](#) on page 1141

[\[:SOURce<hw>\]:BB:MCCW:TRIGger:TIME\[:STATe\]](#) on page 1164

### Trigger Time

Requires trigger "Mode" > "Armed Auto"/"Single".

Sets date and time for a time-based trigger signal.

Set a trigger time that is later than the "Current Time". The current time is the operating system time of the R&S SMW200A. If you set an earlier trigger time than the current time, time-based triggering is not possible.

How to: [Section 5.5.4, "Time-based triggering"](#), on page 263

"Date" Sets the date of the time-based trigger in the format YYYY-MM-DD.

Remote command:

[\[:SOURce<hw>\]:BB:DM:TRIGger:TIME:DATE](#) on page 1078

[\[:SOURce<hw>\]:BB:ARBitrary:TRIGger:TIME:DATE](#)

on page 1140

[\[:SOURce<hw>\]:BB:MCCW:TRIGger:TIME:DATE](#) on page 1163

"Time" Sets the time of the time-based trigger in the format hh:mm:ss.  
 Remote command:  
[\[:SOURce<hw>\]:BB:DM:TRIGger:TIME:TIME](#) on page 1079  
[\[:SOURce<hw>\]:BB:ARBitrary:TRIGger:TIME:TIME](#)  
 on page 1140  
[\[:SOURce<hw>\]:BB:MCCW:TRIGger:TIME:TIME](#) on page 1163

### Arm

Stops the signal generation until subsequent trigger event occurs.

Remote command:

[\[:SOURce<hw>\]:BB:DM:TRIGger:ARM:EXECute](#) on page 1080  
[\[:SOURce<hw>\]:BB:ARBitrary:TRIGger:ARM:EXECute](#) on page 1142  
[\[:SOURce<hw>\]:BB:MCCW:TRIGger:ARM:EXECute](#) on page 1164

### Execute Trigger

Requires trigger "Source" > "Internal"

Executes the trigger manually.

Remote command:

[\[:SOURce<hw>\]:BB:DM:TRIGger:EXECute](#) on page 1080  
[\[:SOURce<hw>\]:BB:ARBitrary:TRIGger:EXECute](#) on page 1142  
[\[:SOURce<hw>\]:BB:MCCW:TRIGger:EXECute](#) on page 1164

### Source

The following sources of the trigger signal are available:

- "Internal"  
The trigger event is internal. Tap "Execute Trigger" to trigger signal generation manually.
- "Internal (Baseband A/B)"  
The trigger event is provided by the trigger signal from the other basebands. If common trigger settings are applied, this trigger source is disabled.
- "External Global Trigger"  
The trigger event is the active edge of an external trigger signal provided and configured at the USER x connectors.
- "External Local Trigger"  
The trigger event is the active edge of an external trigger signal provided and configured at the local T/M/C connector.  
With coupled trigger settings, the signal has to be provided at the T/M/C1/2/3 connectors.
- "External Local Clock"  
The trigger event is the active edge of an external local clock signal provided and configured at the local T/M/C connector.  
With coupled trigger settings, the signal has to be provided at the T/M/C1 connector.
- "Baseband Sync In"  
Requires "Multi Instrument Trigger" > "Secondary" for primary-secondary instrument mode.  
Triggers signal generation at the secondary instrument by the active edge of the baseband synchronization signal of the primary instrument.

"External Local Clock/Trigger" require R&S SMW-B10.

The polarity, the trigger threshold, and the input impedance of the input connectors can be configured in the "Local and global connectors settings" dialog.

See ["Trigger sources"](#) on page 236.

See also [Section 12.2, "Configuring local and global connectors"](#), on page 742.

Remote command:

`[ :SOURce<hw> ] :BB:DM:TRIGger:SOURce` on page 1077

`[ :SOURce<hw> ] :BB:ARBitrary:TRIGger:SOURce` on page 1138

`[ :SOURce<hw> ] :BB:MCCW:TRIGger:SOURce` on page 1162

### **Sync. Output to Ext. Trigger/Sync. Output to Trigger**

Enables signal output synchronous to the trigger event.

See also ["Impact of additional trigger settings"](#) on page 240.

Remote command:

`[ :SOURce<hw> ] :BB:DM:TRIGger:EXtErnal:SYNChronize:OUTPut`  
on page 1080

`[ :SOURce<hw> ] :BB:ARBitrary:TRIGger[:EXtErnal]:SYNChronize:OUTPut`  
on page 1142

`[ :SOURce<hw> ] :BB:MCCW:TRIGger:EXtErnal:SYNChronize:OUTPut`  
on page 1165

### **External Inhibit/Trigger Inhibit**

Sets the duration with that any following trigger event is suppressed. In "Retrigger" mode for example, a new trigger event does not cause a restart of the signal generation until the specified inhibit duration does not expire.

Applies for:

- External trigger signal
- Trigger signal from the other path

See also ["Impact of additional trigger settings"](#) on page 240.

Remote command:

`[ :SOURce<hw> ] :BB:DM:TRIGger[:EXtErnal]:INHibit` on page 1083

`[ :SOURce<hw> ] :BB:DM:TRIGger:OBASeband:INHibit` on page 1081

`[ :SOURce<hw> ] :BB:ARBitrary:TRIGger[:EXtErnal]:INHibit` on page 1145

`[ :SOURce<hw> ] :BB:ARBitrary:TRIGger:OBASeband:INHibit` on page 1143

`[ :SOURce<hw> ] :BB:MCCW:TRIGger[:EXtErnal<ch>]:INHibit` on page 1166

`[ :SOURce<hw> ] :BB:MCCW:TRIGger:OBASeband:INHibit` on page 1165

### **(External) Delay Unit**

Determine whether the trigger delay is expressed in samples or directly defined as a time period (seconds).

To specify the delay, use [\(Specified\) External Delay/\(Specified\) Trigger Delay](#).

The parameter [Actual Trigger Delay/Actual External Delay](#) displays the delay converted in time.

See also ["To set delay and inhibit values"](#) on page 242.



Remote command:

`[ :SOURce<hw> ] :BB:DM:TRIGger:DElay:UNIT` on page 1081

`[ :SOURce<hw> ] :BB:ARBitrary:TRIGger:DElay:UNIT` on page 1144

### (Specified) External Delay/(Specified) Trigger Delay

The name of the parameter and the units the delay is expressed in, changes depending on the parameter ([External Delay Unit](#)).

Delays the trigger event provided by:

- The external trigger source
- The other path
- The other basebands (internal trigger), if common trigger settings are used.
- Other instrument in primary-secondary instrument mode

Use the settings to:

- Synchronize the instrument with the device under test (DUT) or other external devices
- Postpone the signal generation start in the basebands compared to each other
- Compensate for signal delay and align the signals in time

See also the following sections:

- ["Impact of additional trigger settings"](#) on page 240
- ["To set delay and inhibit values"](#) on page 242

Remote command:

`[ :SOURce<hw> ] :BB:DM:TRIGger [ :EXternal ] :DElay` on page 1082

`[ :SOURce<hw> ] :BB:DM:TRIGger:OBASeband:DElay` on page 1080

`[ :SOURce<hw> ] :BB:DM:TRIGger [ :EXternal ] :TDElay` on page 1082

`[ :SOURce<hw> ] :BB:DM:TRIGger:OBASeband:TDElay` on page 1081

`[ :SOURce<hw> ] :BB:ARBitrary:TRIGger [ :EXternal ] :DElay` on page 1144

`[ :SOURce<hw> ] :BB:ARBitrary:TRIGger:OBASeband:DElay` on page 1142

`[ :SOURce<hw> ] :BB:ARBitrary:TRIGger [ :EXternal ] :TDElay` on page 1144

`[ :SOURce<hw> ] :BB:ARBitrary:TRIGger:OBASeband:TDElay` on page 1143

`[ :SOURce<hw> ] :BB:MCCW:TRIGger [ :EXternal<ch> ] :DElay` on page 1165

`[ :SOURce<hw> ] :BB:MCCW:TRIGger:OBASeband:DElay` on page 1165

### Actual Trigger Delay/Actual External Delay

Displays the delay time (in seconds) of an external trigger event or of a trigger event from the other signal path.

See also ["To set delay and inhibit values"](#) on page 242.

Remote command:

`[ :SOURce<hw> ] :BB:DM:TRIGger [ :EXternal ] :RDElay?` on page 1083

`[ :SOURce<hw> ] :BB:DM:TRIGger:OBASeband:RDElay?` on page 1081

`[ :SOURce<hw> ] :BB:ARBitrary:TRIGger [ :EXternal ] :RDElay?` on page 1145

`[ :SOURce<hw> ] :BB:ARBitrary:TRIGger:OBASeband:RDElay?` on page 1143

### Signal Duration

Requires trigger "Mode" > "Single".

Enters the length of the trigger signal sequence.

Use this parameter, for example, for the following applications:

- To output the trigger signal partly.

- To output a predefined sequence of the trigger signal.

Remote command:

[ :SOURce<hw> ] :BB:DM:TRIGger:SLENgth on page 1078

[ :SOURce<hw> ] :BB:ARBitrary:TRIGger:SLUNit on page 1141

[ :SOURce<hw> ] :BB:MCCW:TRIGger:SLENgth on page 1164

### 5.5.2.2 Marker settings

Access:

- ▶ Select "Baseband" > "Custom Digital Mod" > "Marker".

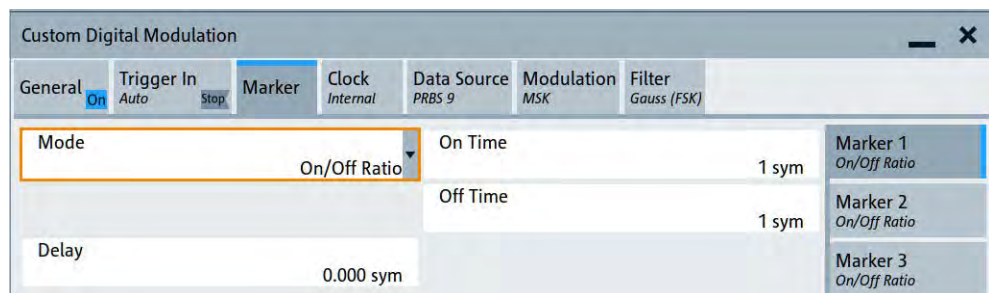

This tab provides settings to select and configure the marker output signal including marker mode and marker delay.

#### Routing and activating a marker signal

1. To define the signal shape of an individual marker signal "x", select "Marker" > "Marker x" > "Mode".
2. Optionally, define the connector for signal output. See [Section 5.5.2.4, "Local and global connectors settings"](#), on page 261.  
You can map marker signals to one or more USER x or T/M connectors.
3. Enable baseband signal generation. In the block diagram, set "Baseband" > "On".  
The R&S SMW200A adds the marker signal to the baseband signal. Also, R&S SMW200A outputs this signal at the configured USER x connector.

#### About marker output signals

This section focuses on the available settings.

For detailed information, see [Section 5.5.1, "About common baseband characteristics"](#), on page 224.

#### Settings:

<a href="#">Mode</a> .....	259
<a href="#">Delay</a> .....	259

**Mode**

Sets the marker mode that defines the shape and periodicity of the marker signal.

You can configure individual marker modes for each marker signal. The number of available markers is 3. The marker configuration changes with the selected marker mode.

How to: "[Routing and activating a marker signal](#)" on page 258

"CList" A marker signal as defined in the selected control list.

Remote command:

[ :SOURce<hw> ] :BB:DM:TRIGger:OUTPut<ch>:MODE on page 1083

[ :SOURce<hw> ] :BB:DM:TRIGger:OUTPut<ch>:PULSe:DIVider on page 1085

[ :SOURce<hw> ] :BB:DM:TRIGger:OUTPut<ch>:PULSe:FREQuency?  
on page 1085

[ :SOURce<hw> ] :BB:DM:TRIGger:OUTPut<ch>:PATtern on page 1084

[ :SOURce<hw> ] :BB:DM:TRIGger:OUTPut<ch>:OFFTime on page 1084

[ :SOURce<hw> ] :BB:DM:TRIGger:OUTPut<ch>:ONTime on page 1084

ARB: see "[Mode](#)" on page 318

[ :SOURce<hw> ] :BB:MCCW:TRIGger:OUTPut<ch>:MODE on page 1166

[ :SOURce<hw> ] :BB:MCCW:TRIGger:OUTPut<ch>:PULSe:DIVider on page 1167

[ :SOURce<hw> ] :BB:MCCW:TRIGger:OUTPut<ch>:PULSe:FREQuency?  
on page 1168

[ :SOURce<hw> ] :BB:MCCW:TRIGger:OUTPut<ch>:PATtern on page 1167

[ :SOURce<hw> ] :BB:MCCW:TRIGger:OUTPut<ch>:ONTime on page 1167

[ :SOURce<hw> ] :BB:MCCW:TRIGger:OUTPut<ch>:OFFTime on page 1167

**Delay**

Delays the marker signal at the marker output relative to the signal generation start.

Variation of the parameter "Marker x" > "Delay" causes signal recalculation.

Remote command:

[ :SOURce<hw> ] :BB:DM:TRIGger:OUTPut<ch>:DELay on page 1085

[ :SOURce<hw> ] :BB:ARBbitrary:TRIGger:OUTPut<ch>:DELay on page 1147

[ :SOURce<hw> ] :BB:MCCW:TRIGger:OUTPut<ch>:DELay on page 1168

**5.5.2.3 Clock settings**

Access:

- ▶ Select "Baseband" > "Custom Digital Mod" > "Clock".

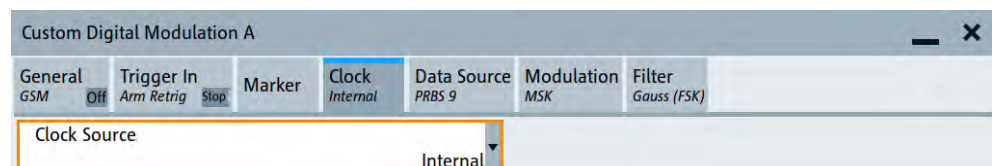

This tab provides settings to select and configure the clock signal, like the clock source and clock mode.

### Defining the clock

1. Select "Clock" > "Source" to define the source of the clock signal.
2. For external clock signals, define the connector for the signal input. See [Section 5.5.2.4, "Local and global connectors settings"](#), on page 261.

You can map clock signals to one or more USER x or T/M connectors.

Local and global connectors settings allow you to configure the signal mapping, the polarity, the trigger threshold and the input impedance of the input connectors.

3. Activate baseband signal generation. In the block diagram, set "Baseband" > "On".

The R&S SMW200A starts baseband signal generation with a symbol rate that equals the clock rate.

### About clock signals

This section focuses on the available settings.

For detailed information, see [Section 5.5.1, "About common baseband characteristics"](#), on page 224.

#### Settings:

<a href="#">Clock Source</a> .....	260
<a href="#">Clock Mode</a> .....	260
<a href="#">Measured External Clock</a> .....	261

#### Clock Source

Selects the clock source.

- "Internal"  
The instrument uses its internal clock reference.
- "External Local Clock"  
Option: R&S SMW-B10  
The instrument expects an external clock reference at the local T/M/C connector.

How to: ["Defining the clock"](#) on page 260

See also [Section 5.5.1.2, "About clock signals"](#), on page 227.

Remote command:

[\[:SOURce<hw>\]:BB:DM:CLOCK:SOURce](#) on page 1086

[\[:SOURce<hw>\]:BB:ARbitrary:CLOCK:SOURce](#) on page 1148

[\[:SOURce<hw>\]:BB:MCCW:CLOCK:SOURce](#) on page 1168

#### Clock Mode

Option: R&S SMW-B10

Sets the type of externally supplied clock.

Remote command:

[\[:SOURce<hw>\]:BB:DM:CLOCK:MODE](#) on page 1086

[\[:SOURce<hw>\]:BB:ARbitrary:CLOCK:MODE](#) on page 1149

[\[:SOURce<hw>\]:BB:MCCW:CLOCK:MODE](#) on page 1169

**Measured External Clock**

Option: R&S SMW-B10

Provided for permanent monitoring of the enabled and externally supplied clock signal.

Remote command:

:CLOCK:INPut:FREQuency? on page 922

**5.5.2.4 Local and global connectors settings**

Opens a dialog to configure local connectors or global connectors.

The button is available in the following dialogs or tabs:

- "Trigger / Marker / Clock" dialog that is accessible via the "TMC" block in the block diagram.
- "Trigger In", "Marker" and "Clock" tabs of baseband signal configuration dialogs that you can open via the "Baseband" block in the block diagram. These tabs are available, for example, for "ARB" baseband signals.



See also [Section 12.2, "Configuring local and global connectors"](#), on page 742.

**5.5.3 Triggering with a common signal**

In test setups that combine the signal of two or more instruments and/or basebands it is often required that:

- The signal generation starts at a defined moment
- The signal generation starts simultaneously (or with an exactly defined delay) in:
  - All involved instruments
  - All basebands of the same R&S SMW200A

This section explains how to fulfill the last requirement with the provided trigger settings. Use one of the following possibilities:

- ["To use the external global trigger signal of the instrument"](#) on page 261
- ["To use the internal trigger signal of the instrument"](#) on page 262
- ["To use the external local trigger signal of the instrument"](#) on page 262

See also:

- [Section 5.5.1.5, "About trigger signals"](#), on page 235 for background information
- [Section 10.3.1, "Connecting multiple instruments in primary-secondary instrument mode"](#), on page 664 for information on simultaneous signal generation start in multiple instruments.

**To use the external global trigger signal of the instrument**

An external *global* trigger/clock signal can be supplied to one or simultaneously to all the basebands.

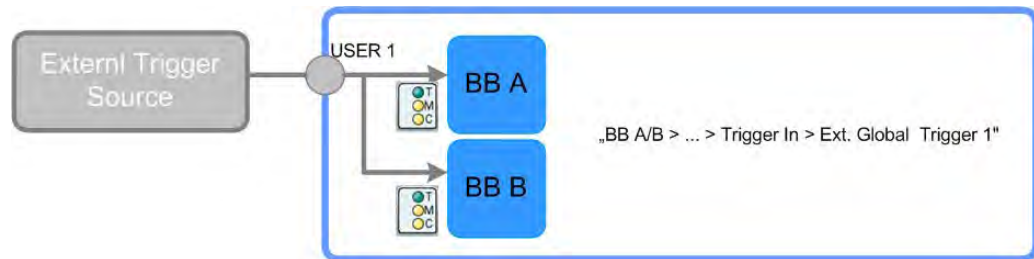

To trigger commonly all basebands and to assure a synchronous generation start with the global trigger/clock signal, proceed as follows:

- ▶ Enable the same trigger source for both basebands.  
For example, select "Trigger In" > "Source" > "External Global Trigger 1".

The instrument uses the external trigger signal for both basebands.

#### To use the internal trigger signal of the instrument

Internal trigger signals are generated by the instrument self and can be used independently per baseband or routed from one to the other.

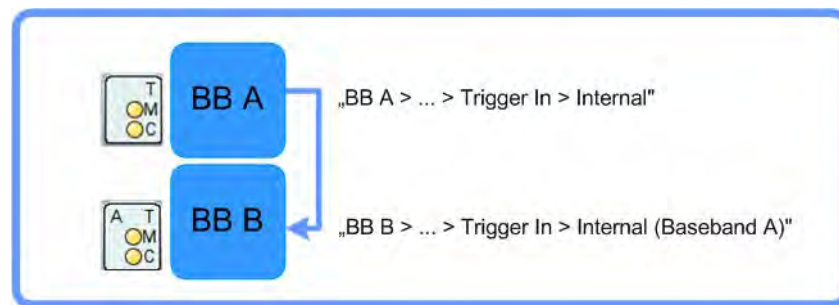

To use this feature to synchronize the signal generation start in the basebands, proceed as follows:

1. In the first baseband, proceed as follows:
  - a) Select "Baseband A" > "Cust Dig Mod" > "Trigger In" > "Mode" > "Armed Auto".
  - b) Select "Source" > "Internal".
2. In the second baseband, proceed as follows:
  - a) Select "Baseband B" > "Cust Dig Mod" > "Trigger In" > "Mode" > "Armed Auto".
  - b) Select "Source" > "Internal (Baseband A)".

#### To use the external local trigger signal of the instrument

An external *local* trigger/clock signal is dedicated to the baseband board at which this signal is supplied (i.e. the board the local T/M/C connector is located).

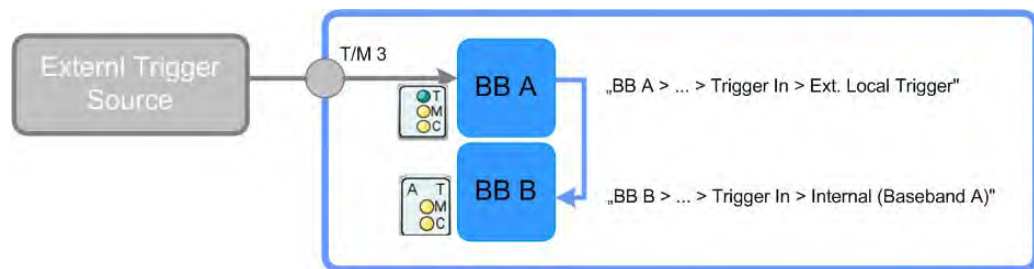

To route internally this signal and to use it for synchronous triggering of all other basebands, proceed as follows:

1. Configure one of the local T/M connectors as the input for the external local trigger signal:
  - a) "Baseband" > "Cust Dig Mod" > "Trigger In" > "Local Connectors"
  - b) In the "Local Connectors" dialog, select "T/M 3" > "Direction" > "Input".
  - c) Select "Signal" > "Trigger".
2. In the first baseband, proceed as follows:
  - a) Select "Baseband A" > "Cust Dig Mod" > "Trigger In" > "Mode" > "Armed Auto".
  - b) Select "Source" > "External Local Trigger".
3. In the second baseband, proceed as follows:
  - a) Select "Baseband B" > "Cust Dig Mod" > "Trigger In" > "Mode" > "Armed Auto".
  - b) Select "Source" > "Internal (Baseband A)".
4. Use a suitable cable to connect the external trigger source to the T/M 3 connector of the R&S SMW200A.

See ["To find out the input connector location"](#) on page 761.

The connector is at the rear of the instrument, on the left part of the topmost CODER board.

#### 5.5.4 Time-based triggering

To synchronize signal generation of the R&S SMW200A to a common time reference, use the time-based trigger. Synchronization is useful for time-sensitive signal generation tasks.

These tasks meet, for example, the following requirements:

- Absolute time reference for radar signal generation
- Radar system synchronization to a common time
- GNSS simulation time synchronization to GPS time

##### Test setup for internal time reference

The R&S SMW200A is sufficient in a test setup and uses its internal time reference for triggering.

### Test setup for coarse external time reference

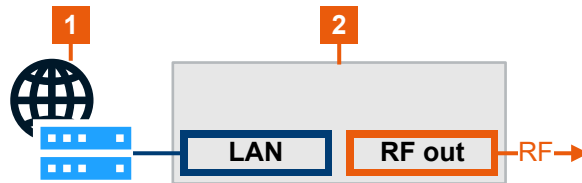

1 = NTP server  
2 = R&S SMW200A

### Test setup for fine external time reference

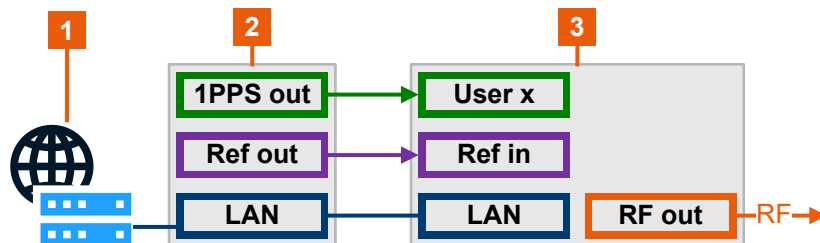

1 = NTP server  
2 = Time reference source  
3 = R&S SMW200A

The following step-by-step instructions provide information on how to trigger signal generation to a specific time reference. These instructions use the ARB as a baseband signal source. The configuration in other baseband configuration dialogs is analogous.

- ["To open time-based trigger settings"](#) on page 264
- ["To trigger to the internal time reference"](#) on page 265
- ["To trigger coarsely to an external time reference"](#) on page 265
- ["To trigger finely to an external time reference"](#) on page 266

#### To open time-based trigger settings

1. Select "Baseband" > "ARB" > "Trigger In".
2. Select "Mode" > "Single"/"Armed Auto".

For these trigger modes, the R&S SMW200A provides settings to trigger baseband signal generation at a defined time reference. You can configure external or internal trigger events. The configuration of these events is specific for each baseband signal.



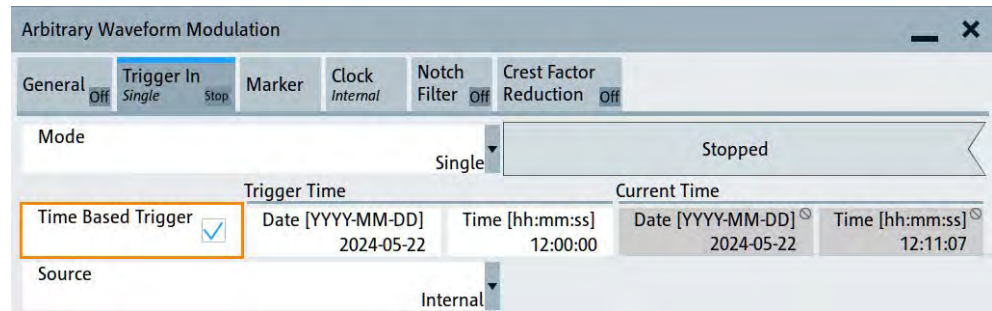

### To trigger to the internal time reference

To trigger to the operating system time or an arbitrary internal time at the R&S SMW200A, proceed as follows:

1. Open the time-based trigger settings of your digital baseband signal. For example, see ["To open time-based trigger settings"](#) on page 264.
2. To configure "Trigger Time" settings, set "Time" and "Date", for example:
  - a) Set "Time" > "11:00:00".
  - b) Set "Date" > "2023-09-25".
3. Select "Source" > "Internal".
4. To activate signal generation at this specified time, select "Time Based Trigger" > "On".
5. Optionally, define an arbitrary internal time. To edit the "Current Time" settings, unlock the operating system time:
  - a) Select "System Config" > "Setup" > "Security" > "Protection".
  - b) Enter the protection level 1 password. See ["Protection levels"](#) on page 794.
  - c) Set "Date" and "Time" of the "Current Time" settings as needed.
6. Set "Baseband" > "ARB" > "State" > "On".

The R&S SMW200A starts signal generation, if the "Current Time" matches the "Trigger Time". The accuracy of the trigger point is on the order of milliseconds. If you need a higher accuracy on the order of microseconds, proceed with ["To trigger finely to an external time reference"](#) on page 266.

### To trigger coarsely to an external time reference

1. Follow the instructions in ["To trigger to the internal time reference"](#) on page 265 until step (2).
2. Connect a suitable external time reference to the "LAN" connector of the instrument. This time reference provides time information from an NTP server.
3. Specify the NTP server address:
  - a) Select "System Config" > "Setup" > "Maintenance" > "Date / Time".

- b) Select "Time Protocol" > "NTP".
  - c) Enter the address of the NTP server.
4. Set "Baseband" > "ARB" > "State" > "On".

The R&S SMW200A starts the signal generation if the "Current Time" matches the "Trigger Time" from the NTP server. The accuracy of the trigger point is on the order of milliseconds.

If you need a higher accuracy on the order of microseconds, proceed with ["To trigger finely to an external time reference"](#) on page 266.

#### To trigger finely to an external time reference

1. Follow the instructions in ["To trigger to the internal time reference"](#) on page 265 until step (2).
2. Connect a suitable external time reference that collects time information from an NTP server:
  - a) For the reference signal, use the "REF IN" connector.
  - b) For the trigger signal, use one of the "USER x" connectors, for example "USER 1".

The R&S SMW200A expects a 10 MHz reference signal at the "REF IN" connector and a 1PPS trigger signal at the "USER x" connector.

3. Configure the R&S SMW200A for input of the external trigger signal:
  - a) Select "Baseband" > "ARB" > "Trigger In".
  - b) Select "Source" > "External Global Trigger 1".
  - c) Select "Global Connectors" > "Routing".
  - d) For "Connector" > "User 1", select "Direction" > "Input".
  - e) Select "Signal" > "Global Trigger 1".
4. Configure the R&S SMW200A for input of the reference signal:
  - a) In the status bar, select "Ext Ref" > "Reference Frequency".
  - b) Select "Source" > "External".
  - c) Select "External Reference Frequency" > "10 MHz".
5. Select "Baseband" > "ARB" > "Trigger In".
6. Select "Time Based Trigger" > "On".
7. Set "Baseband" > "ARB" > "State" > "On".

## 5.6 Generating custom digital modulation signals

The R&S SMW200A can generate digital modulation signals with user-definable characteristics. The baseband filtering and the symbol rate can be set within wide limits.

### 5.6.1 Required options

The equipment layout for generating the digital modulation signals includes:

- Option standard or wideband baseband generator (R&S SMW-B10/-B9) per signal path
- Option baseband main module, one/two I/Q paths to RF (R&S SMW-B13/-B13T) or Option wideband baseband main module two I/Q paths to RF (R&S SMW-B13XT)

### 5.6.2 About custom digital modulation

An introduction to the supported filter, modulation, and coding schemes are provided in:

- [Section 5.5.1.8, "Supported baseband filters"](#), on page 247
- [Section 5.5.1.6, "Supported modulation signals"](#), on page 245
- [Section 5.5.1.7, "Supported coding schemes"](#), on page 246.

#### About modulation types and coding schemes

Modulation types and coding schemes directly relate to each other. You cannot use all coding schemes for each modulation type. For available coding schemes, see [Section 5.6.5.1, "Default settings and predefined configurations"](#), on page 292.

An inappropriate change of a parameter triggers a settings conflict. The "Info" line displays this conflict with an info message. Although the R&S SMW200A displays the selected settings, the generated modulation signal does not correspond to this display. The conflict message disappears if you configure a conflict-free setting.

### 5.6.3 Custom digital modulation settings

Access:

- ▶ Select "Baseband" > "Custom Digital Mod".

The "Custom Digital Modulation" dialog provides settings to select the data source, the modulation standard, the symbol rate, the coding scheme, the modulation type and the baseband filter.

The remote commands required to define these settings are described in [Section 14.19.5.2, "SOURce:BB:DM subsystem"](#), on page 1060.

#### Settings:

- [General settings](#).....268
- [Trigger, marker and clock settings](#)..... 270
- [Data source settings](#)..... 270
- [Modulation settings](#)..... 276
- [Filter settings](#).....278

- [Power ramp control settings](#).....280
- [Data list editor](#)..... 282
- [Control and marker lists editor](#)..... 284

### 5.6.3.1 General settings

Access:

- ▶ Select "Baseband" > "Custom Digital Mod".

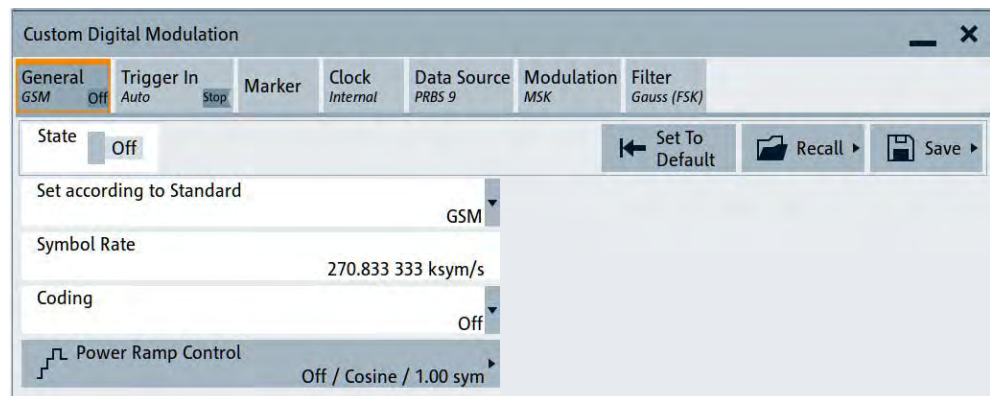

This tab provides settings to configure the default settings, save and recall settings and general settings to configure a custom digital modulation signal. These settings include a configuration that conforms with a standard or a user-defined configuration of the digital modulation signal.

#### Settings:

<a href="#">State</a> .....	268
<a href="#">Set To Default</a> .....	268
<a href="#">Save/Recall</a> .....	269
<a href="#">Set according to Standard</a> .....	269
<a href="#">Symbol Rate</a> .....	269
<a href="#">Coding</a> .....	270
<a href="#">Power Ramp Control</a> .....	270

#### State

Enables digital modulation. Switching on digital modulation turns off all other digital standards.

The digital modulation is generated in real time (no precalculated signal), and therefore while the digital modulation is enabled, all parameter changes directly affect the output signal.

Remote command:

[ :SOURce<hw> ] :BB:DM:STATe on page 1063

#### Set To Default

Calls default settings. The table [Table 5-11](#) lists the most important values.

Remote command:

[ :SOURce<hw> ] :BB:DM:PRESet on page 1064

### Save/Recall

Opens the "Save/Recall" dialog that is the standard instrument function for saving and recalling the complete dialog-related settings in a file. The provided navigation possibilities in the dialog are self-explanatory.

The settings are saved in a file with a predefined extension. You can define the file-name and the directory, in that you want to save the file.

See also [Section 11.4, "Saving and recalling settings"](#), on page 708.

Remote command:

[ :SOURce<hw> ] :BB:DM:SETTing:CATalog? on page 1067

[ :SOURce<hw> ] :BB:DM:SETTing:DELeTe on page 1068

[ :SOURce<hw> ] :BB:DM:SETTing:LOAD on page 1068

[ :SOURce<hw> ] :BB:DM:SETTing:STORe on page 1068

### Set according to Standard

Selects a predefined communication standard.

Communication standard

Selects a predefined communication standard. If selected, the firmware automatically sets standard-compliant values for the following parameters: "Modulation Type", "Symbol Rate", "Filter" and "Coding". For "Set according to Standard" > "Telemetry - SOQPSK-TG", the "Data Source" is "Data List" only. See [Section 5.6.3.3, "Data source settings"](#), on page 270. See [Table 5-12](#) for an overview of the available standards and standard-compliant settings of the modulation parameters.

"User" Set automatically, this value indicates a modification made on at least one of the parameters.

Use the "Save"/"Recall" function to save and recall customized settings.

"CW in Baseband"

Generates a continuous wave signal as a BPSK modulated signal with "Data Source" > "All 1".

Note that this setting also keeps the data source "All 1", if you change to another communication standard. The "CW in Baseband" signal is useful for phase coherence applications, and a test signal for testing and debugging.

Remote command:

[ :SOURce<hw> ] :BB:DM:STANdard on page 1064

### Symbol Rate

Selects the symbol rate. The value range of this parameter depends on the selected modulation type; the range is automatically redefined.

An error message appears if the selected symbol rate is outside of the redefined range. The symbol rate is set automatically to the maximum allowed value for the new modulation.

Remote command:

[ :SOURce<hw> ] :BB:DM:SRATe on page 1064

### Coding

Sets the coding scheme, see [Section 5.5.1.7, "Supported coding schemes"](#), on page 246.

The dialog shows only the coding settings that are permissible for the selected modulation type and installed options, see [Table 5-14](#). All other coding methods are grayed out.

A subsequent modification to a modulation type for which the selected coding is not available, automatically disables the coding ("Coding = Off").

Remote command:

[ :SOURce<hw> ] :BB:DM:CODing on page 1071

### Power Ramp Control

Accesses the power ramp control dialog, see [Section 5.6.3.6, "Power ramp control settings"](#), on page 280.

## 5.6.3.2 Trigger, marker and clock settings

These tabs provide standard settings.

For detailed description, see:

- [Section 5.5.2.1, "Trigger settings"](#), on page 252
- [Section 5.5.2.2, "Marker settings"](#), on page 258
- [Section 5.5.2.3, "Clock settings"](#), on page 259
- [Section 5.5.2.4, "Local and global connectors settings"](#), on page 261

## 5.6.3.3 Data source settings

Access:

- ▶ Select "Baseband" > "Custom Digital Mod" > "Data Source".

This tab provides access to the settings necessary to select and configure the data source, like access to data and list editors or direct selection of PRBS data.

For an overview of the supported data sources, refer to [Section 5.5.1.1, "About data signals"](#), on page 224.

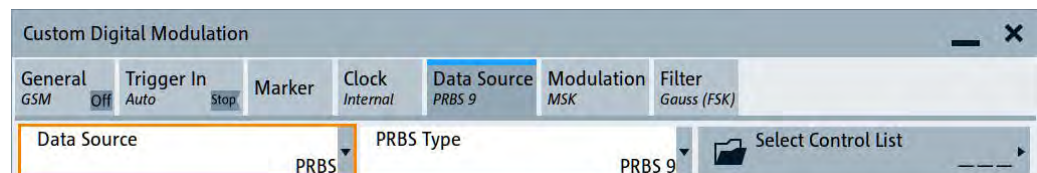

**To access external serial data settings**

Provide the external serial data and clock signals at the connectors listed in [Table 5-3](#).

1. If you use a wideband baseband generator (R&S SMW-B9), select "System Configuration" > "Fading/Baseband Config" > "Mode" > "Advanced".
2. In the "Custom Digital Mod" > "Data Source" tab, select "Data Source" > "External".

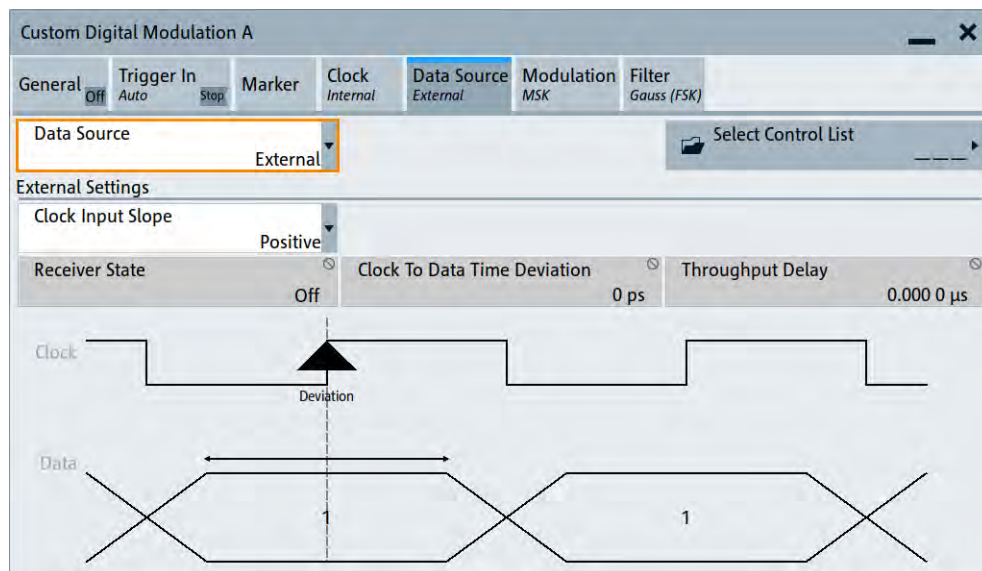

3. If your setup requires higher order modulation, select for example "Modulation" > "Modulation Type" > "PSK" > "QPSK".

**Settings:**

Data Source.....	271
Select Data List.....	272
Select Control List.....	272
Settings for Data Source > External.....	273
L Receiver State.....	273
L Clock Input Slope.....	274
L Bit Clock Slope.....	274
L Bit Order.....	274
L Clock to Data Time Deviation.....	274
L Throughput Delay.....	274
L Graphical illustration of the timing ratios between the data and clock signals	
.....	275
Connector Settings.....	275

**Data Source**

Selects the data source (see [Section 5.5.1.1, "About data signals"](#), on page 224).

The following data sources are available:

"All 0, All 1"      A sequence containing 0 data or 1 data is internally generated.

**"PRBS, PRBS Type"**

Selects internally generated PRBS data in accordance with the IUT-T. Use the parameter "PRBS Type" to define the length.

Remote command:

`[ :SOURce<hw> ] :BB:DM:PRBS [ :LENGth ]` on page 1065

**"Pattern"**

Use the "Pattern" box to define a bit pattern with a maximum length of 64 bits.

Remote command:

`[ :SOURce<hw> ] :BB:DM:PATtern` on page 1065

**"Data List"**

Binary data from data lists are used, see [Select Data List](#).

Remote command:

`[ :SOURce<hw> ] :BB:DM:DLISt:CATalog?` on page 1086

`[ :SOURce<hw> ] :BB:DM:DLISt:SElect` on page 1087

**"External"**

Uses externally supplied serial data, see ["External modulation data"](#) on page 226. Data and clock signals are expected at the corresponding connectors.

Remote command:

`[ :SOURce<hw> ] :BB:DM:SOURce` on page 1065

**Select Data List**

Opens the standard "Select List" dialog to select an existing data list or to create a one.

Generate data lists externally or internally in the data editor.

- Select "Select Data List", navigate to the list file `*.dm_iqd` and tap "Select".
- Use the standard "File Manager" function to transfer external data lists to the instrument.
- Use the functions "New" or "Edit" to create a data list or to edit an existing data list, see [Section 5.6.3.7, "Data list editor"](#), on page 282.

See also [Section 5.6.4.2, "How to create and assign a data list"](#), on page 290.

Remote command:

`[ :SOURce<hw> ] :BB:DM:DLISt:CATalog?` on page 1086

`[ :SOURce<hw> ] :BB:DM:DLISt:SElect` on page 1087

`[ :SOURce<hw> ] :BB:DM:DLISt:COpy` on page 1090

`[ :SOURce<hw> ] :BB:DM:DLISt:DElete` on page 1088

**Select Control List**

Accesses the standard "Select List" dialog to select an existing control list or to create a one.

Control lists can be generated externally or internally in the "Control and Marker Lists" editor.

- Select "Select Control List", navigate to the list file `*.dm_iqc` and tap "Select".
- Use the standard "File Manager" function to transfer external lists to the instrument.
- Use the functions "New" or "Edit" to create a data list or to edit an existing data list, see [Section 5.6.3.8, "Control and marker lists editor"](#), on page 284.



Irrespectively on the way they are created, control lists are not automatically used (see ["To assign and activate control signals from a control list"](#) on page 290).

Remote command:

[ :SOURce<hw> ] :BB:DM:CLISt:CATalog? on page 1086

[ :SOURce<hw> ] :BB:DM:CLISt:SElect on page 1087

[ :SOURce<hw> ] :BB:DM:CLISt:COpy on page 1090

[ :SOURce<hw> ] :BB:DM:CLISt:DElete on page 1087

### Settings for Data Source > External

In a wideband baseband generator (R&S SMW-B9), select "System Config" > "Fading/Baseband Config" > "Mode" > "Advanced".

### Receiver State ← Settings for Data Source > External

Indicates the current state of the receiver of the external data. The displayed information is useful in erroneous situations.

"Off" Indicates that the baseband is not active.

"Operational" Indicates a normal operation; the data is received with the expected data rate.

"Overflow" Data rate is too high for correct processing; symbols have been lost. This indication is displayed as long as the signal is not restarted.

**Tip:** Try out the following:

- Check the data rate of the input signal.
- Provide the data source and the R&S SMW200A with a common external reference signal.

See [Section 8.8, "Reference oscillator"](#), on page 491.

- Provide an external clock signal to the R&S SMW200A. See ["Clock Source"](#) on page 260.
- Avoid reflections on the data and clock lines. The R&S SMW200A can interpret reflections on the data and clock lines as extra clock edges.

"Underflow" Data rate is too low or data is missing; zero symbols have been inserted.

This indication is displayed as long as the signal is not restarted.

**Tip:** Try out the following:

- Check that the data and clock cables are connected to R&S SMW200A.
- Check the data rate of the input signal.
- Provide the data source and the R&S SMW200A with a common external reference signal.

See [Section 8.8, "Reference oscillator"](#), on page 491.

- Provide an external clock signal to the R&S SMW200A. See ["Clock Source"](#) on page 260.
- Check the value of the parameter [Local Connector Settings > Threshold Clock](#).

If the configured threshold is higher than the signal's "high" voltage, the signal is not detected.

Remote command:

`[ :SOURce<hw> ] :BB:DM:SMODulation:RCVState?` on page 1067

#### **Clock Input Slope** ← **Settings for Data Source** > **External**

Sets the polarity of the active slope of an externally applied clock signal.

When using custom digital modulation with external serial data, a higher bit modulation requires a reference symbol clock signal. You need this reference signal to generate a bit clock out of it.

- This parameter sets the active edge of the symbol clock.
- To set the active edge of the bit clock, use the parameter "Bit Clock Slope".
- Observe the impact of this parameter on the preview graphic in the "Data Source" tab: "Baseband" > "Custom Digital Mod" > "Data Source".  
See also "[External modulation data](#)" on page 226.

Remote command:

`[ :SOURce<hw> ] :INPut:TM:CLOCK:SLOPe` on page 1015

#### **Bit Clock Slope** ← **Settings for Data Source** > **External**

Option: R&S SMW-B10

Sets the active edge of the bit clock.

Timing deviations between the clock and the data signals that are smaller than  $\pm 1/16$  of the clock period, are:

- Automatically corrected
- Indicated with the parameter [Clock to Data Time Deviation](#)

Observe the impact of this parameter on the preview graphic.

See also "[External modulation data](#)" on page 226.

Remote command:

`[ :SOURce<hw> ] :BB:DM:SMODulation:CLOCK:SLOPe:BIT` on page 1066

#### **Bit Order** ← **Settings for Data Source** > **External**

Sets the bit order, **LSB** or **MSB** first, used to process the externally supplied higher bit modulation serial data.

See also "[External modulation data](#)" on page 226.

Remote command:

`[ :SOURce<hw> ] :BB:DM:SMODulation:BORDER` on page 1066

#### **Clock to Data Time Deviation** ← **Settings for Data Source** > **External**

Indicates timing deviations between the clock and the data signals. Timing deviations that are smaller than  $\pm 1/16$  of the clock period are automatically corrected.

See also "[External modulation data](#)" on page 226.

Remote command:

`[ :SOURce<hw> ] :BB:DM:SMODulation:CDTDeviation` on page 1066

#### **Throughput Delay** ← **Settings for Data Source** > **External**

Indicates the time delay between the active clock edge for the extern data and the center of the modulation symbol (associated with this data item) on the RF connectors, see [Figure 5-15](#).

**Example:**

- "Data Source" > "External"
- Modulation with 3 bits per symbol
- "Symbol Clock Slope" > "Positive" means that the active edge of the symbol clock is the rising edge
- Clock active edge falls at the center of the first bit of each symbol

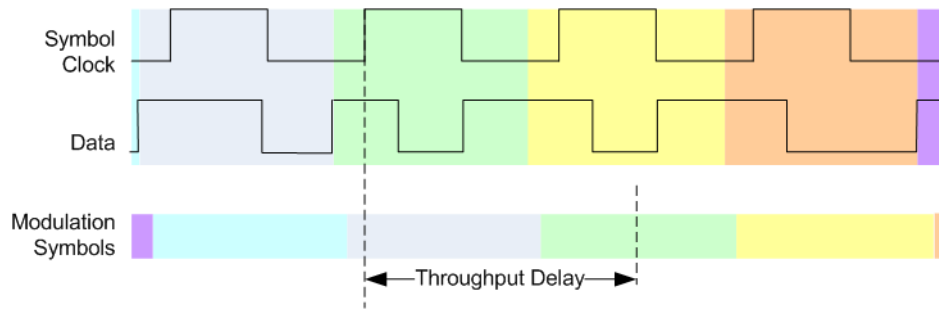

**Figure 5-15: Throughput delay (symbols indicated by different colors)**

The throughput delay is the time between center points: The center of the modulation symbol at the RF output and the center of the first bit in each symbol in the external data.

Remote command:

`[ :SOURce<hw> ] :BB:DM:SMODulation:THRoughput:DELay?` on page 1067

### Graphical illustration of the timing ratios between the data and clock signals ← Settings for Data Source > External

A graph illustrates the timing relation, depending on the selected:

- "Bit Clock Slope" on page 274
- "Clock Input Slope" on page 274
- "Bit Order" on page 274

### Connector Settings

Option: R&S SMW-B10

Opens a dialog to configure connector settings.

See also [Section 12.2, "Configuring local and global connectors"](#), on page 742.

### 5.6.3.4 Modulation settings

Access:

- ▶ Select "Baseband" > "Custom Digital Mod" > "Modulation".

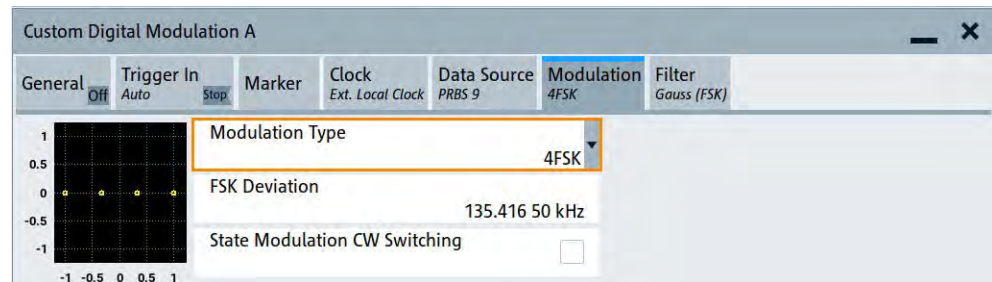

This tab provides the modulation settings, for example, modulation type, FSK deviation or modulation depth. Also, a graphic shows the theoretical constellation diagram of the selected modulation.



This section focuses on the available settings. For background information on how the settings affect the signal and the filter characteristics, refer to [Section 5.5.1.6, "Supported modulation signals"](#), on page 245.

#### Settings:

Modulation Type.....	276
Load User Mapping.....	276
ASK Depth.....	277
FSK Deviation.....	277
Angle Alpha.....	277
FSK Type.....	277
Deviation xxxx.....	277
Gamma/Gamma 1.....	278
State Modulation CW Switching.....	278

#### Modulation Type

Selects a modulation type. The associated symbol mapping is displayed.

If the configured modulation type does not allow a specific coding scheme, the "Coding" is "Off".

See also [Table 5-13](#).

Remote command:

[ : SOURce<hw> ] : BB : DM : FORMat on page 1071

#### Load User Mapping

Opens the "Select List File User Mapping" dialog to select the mapping table (see ["User mapping"](#) on page 246). The dialog provides all standard file management functions.

Remote command:

`[ :SOURce<hw> ] :BB:DM:MLIST:SElect` on page 1087

`[ :SOURce<hw> ] :BB:DM:MLIST:CATalog?` on page 1086

`[ :SOURce<hw> ] :BB:DM:MLIST:DElete` on page 1088

### ASK Depth

Sets the modulation depth  $m$  for ASK modulation.

$$m = (Amplitude_{max} - Amplitude_{min}) / (Amplitude_{max} + Amplitude_{min})$$

Remote command:

`[ :SOURce<hw> ] :BB:DM:ASK:DEPTH` on page 1072

### FSK Deviation

Sets the frequency deviation for FSK modulation. The range of values depends on the symbol rate, see "[Symbol Rate](#)" on page 269.

For more information, refer to the specifications document.

If you select "Modulation Type" > "FSK" > "MSK", the FSK deviation has a fixed value of 1/4 of the symbol rate.

Remote command:

`[ :SOURce<hw> ] :BB:DM:FSK:DEVIation` on page 1072

### Angle Alpha

For AQPSK modulation, sets the angle alpha between the point (0,0) and the I axis.

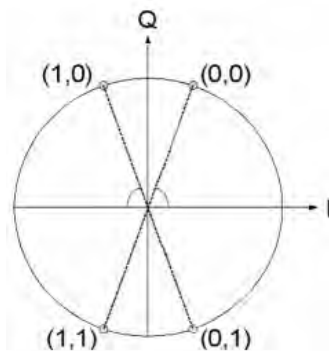

Remote command:

`[ :SOURce<hw> ] :BB:DM:AQPSk:ANGLE` on page 1071

### FSK Type

For "Variable FSK", selects the FSK modulation type.

Available are 4FSK, 8FSK and 16FSK.

Remote command:

`[ :SOURce<hw> ] :BB:DM:FSK:VARiable:TYPE` on page 1073

### Deviation xxxx

For "Variable FSK", sets the deviation of the associated symbol. The number of symbols depends on the selected modulation type. The value of each symbol is indicated in binary format, i.e.  $x$  can be 1 or 0.

Remote command:

`[ :SOURce<hw> ] :BB:DM:FSK:VARIABLE:SYMBOL<ch0>:DEVIation` on page 1072

### Gamma/Gamma 1

Selects the gamma function  $\gamma$  for the 16APSK and 32APSK modulations.

The values in brackets indicate the used code rate according to the DVB-S2 specification.

Remote command:

`[ :SOURce<hw> ] :BB:DM:APSK16:GAMMa` on page 1073

`[ :SOURce<hw> ] :BB:DM:APSK32:GAMMa` on page 1073

### State Modulation CW Switching

Requires option R&S SMW-B10 or R&S SMW-B9 with "System Config" > "Fading/Baseband Config" > "Mode" > "Advanced".

Enables switching between the digitally modulated and an unmodulated (CW) signal.

Remote command:

`[ :SOURce<hw> ] :BB:DM:SWITching:STATE` on page 1074

## 5.6.3.5 Filter settings

Access:

- ▶ Select "Baseband" > "Custom Digital Mod" > "Filter".

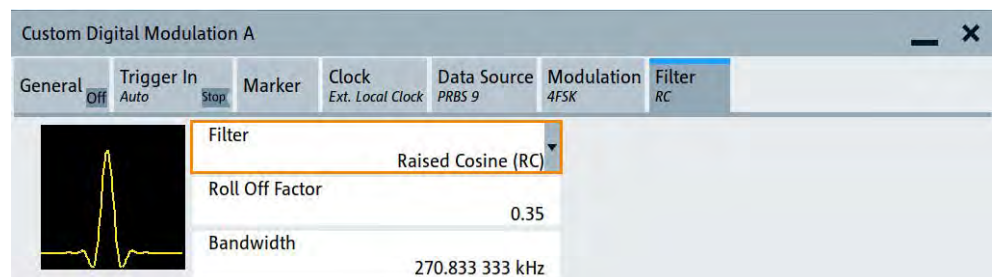

This tab provides filter settings, like filter type and if available further filter settings. A simplified diagram shows the filter characteristics of the selected filter.



This section focuses on the available settings. For background information on how the settings affect the signal and the filter characteristics, refer to [Section 5.5.1.8, "Supported baseband filters"](#), on page 247.

### Settings:

Filter.....	279
Roll Off Factor/B*T.....	279
Cut Off Frequency Factor.....	279

Gauss Cut Off FrequencyLowpass Cut Off Frequency.....	279
Bandwidth.....	279
Load User Filter.....	280

**Filter**

Selects the baseband filter.

See [Section 5.6.5.3, "Predefined baseband filters"](#), on page 297 for an overview of the available filter types, their filter shapes and filter parameters.

Remote command:

`[ :SOURce<hw> ] :BB:DM:FILTer:TYPE` on page 1069

**Roll Off Factor/B\*T**

Sets the rolloff factor or bandwidth time product of the corresponding filter type.

Remote command:

`[ :SOURce<hw> ] :BB:DM:FILTer:PARAmeter:APCO25` on page 1069

`[ :SOURce<hw> ] :BB:DM:FILTer:PARAmeter:COSSine[:ROLLoff]` on page 1069

`[ :SOURce<hw> ] :BB:DM:FILTer:PARAmeter:GAUSSs` on page 1069

`[ :SOURce<hw> ] :BB:DM:FILTer:PARAmeter:PGAuss` on page 1069

`[ :SOURce<hw> ] :BB:DM:FILTer:PARAmeter:RCOSSine` on page 1069

`[ :SOURce<hw> ] :BB:DM:FILTer:PARAmeter:SPHase` on page 1069

**Cut Off Frequency Factor**

Requires the filter parameter "Lowpass (ACP optim.)" and "Lowpass (EVM optim.)".

Sets the cutoff frequency factor. Adjust the cutoff frequency of the filter to meet your spectrum mask requirements.

Remote command:

`[ :SOURce<hw> ] :BB:DM:FILTer:PARAmeter:LPASSs` on page 1069

`[ :SOURce<hw> ] :BB:DM:FILTer:PARAmeter:LPASSEVM` on page 1069

**Gauss Cut Off FrequencyLowpass Cut Off Frequency**

Requires the filter parameter "APCO25 (LSM)".

Sets the cutoff frequency of the filter. Adjust the cutoff frequency of the filter to meet your spectrum mask requirements.

Remote command:

`[ :SOURce<hw> ] :BB:DM:FILTer:PARAmeter:APCO25Lsm:GAUSSs` on page 1069

`[ :SOURce<hw> ] :BB:DM:FILTer:PARAmeter:APCO25Lsm:LOWPass` on page 1069

**Bandwidth**

Requires "Filter" > "Raised Cosine (RC)".

Sets the filter bandwidth, so that the equation  $H(f) = 0$  holds for  $f \geq (1 + \text{rolloff}) * \text{bandwidth} / 2$ .

Remote command:

`[ :SOURce<hw> ] :BB:DM:FILTer:PARAmeter:COSSine:BANDwidth` on page 1069

**Load User Filter**

Opens the dialog "Select User Filter" to load a user-defined filter file with file extension \*.vaf. This dialog provides the standard file management functions, like save, load, delete.

See also "[User filter](#)" on page 247.

Remote command:

[ :SOURce<hw> ] :BB:DM:FLISt:SElect on page 1087

[ :SOURce<hw> ] :BB:DM:FLISt:CATalog? on page 1086

[ :SOURce<hw> ] :BB:DM:FLISt:DElete on page 1087

**5.6.3.6 Power ramp control settings**

Access:

- ▶ Select "Baseband" > "Custom Digital Mod" > "General" > "Power Ramp Control".

State	Off
Source	Internal
Ramp Function	Cosine
Ramp Time	1.00 sym
Rise Delay	0.00 sym
Fall Delay	0.00 sym
Attenuation	15.0 dB
Power Ramping / Level Attenuation	
In Baseband Only	<input type="checkbox"/>

The dialog comprises the settings used to configure the power ramping, like the source of the control signals, the form of the ramp function and the applied attenuation.

See also "[Power ramping and level attenuation](#)" on page 229.



Power ramping is possible for symbol rates up to 5 MHz. A higher symbol rate disables the power ramping automatically and an error message is output.

**Settings:**

<a href="#">State</a> .....	281
<a href="#">Source</a> .....	281
<a href="#">Ramp Function</a> .....	281
<a href="#">Ramp Time</a> .....	281
<a href="#">Rise Delay</a> .....	281



Fall Delay.....	281
Attenuation.....	282
In Baseband Only.....	282

**State**

Enables/disables power ramping.

Remote command:

[ :SOURce<hw> ] :BB:DM:PRAMP [ :STATe ] on page 1076

**Source**

Defines the source for the power ramp control signals.

"Internal"            The control signals as defined in the internal control list are used for control purposes.

See also [Section 5.6.4.1, "How to create and assign a control list"](#), on page 288.

Remote command:

[ :SOURce<hw> ] :BB:DM:PRAMP:SOURce on page 1074

**Ramp Function**

Selects the ramp function that describes the shape of the rising and falling edges during power ramp control, see [Figure 5-4](#).

"Linear"              The transmit power rises and falls in linear fashion.

"Cosine"             The transmit power rises and falls with a cosine-shaped edge, resulting in a more favorable spectrum than the "Linear" setting.

Remote command:

[ :SOURce<hw> ] :BB:DM:PRAMP:SHAPE on page 1074

**Ramp Time**

Enters the power ramping rise time and the fall time for a burst. The setting is expressed in symbols. See also [Figure 5-4](#).

Remote command:

[ :SOURce<hw> ] :BB:DM:PRAMP:TIME on page 1075

**Rise Delay**

Sets the offset in the rising edge of the envelope at the start of a burst, see [Figure 5-4](#).

A positive value delays (the envelope length decreases) and a negative value causes an advance (the envelope length increases). The setting is expressed in symbols.

Remote command:

[ :SOURce<hw> ] :BB:DM:PRAMP:RDELay on page 1075

**Fall Delay**

Sets the offset in the falling edge of the envelope at the end of a burst, see [Figure 5-4](#).

A positive value delays (the envelope length increases) and a negative value causes an advance (the envelope length decreases). The setting is expressed in symbols.

Remote command:

[ :SOURce<hw> ] :BB:DM:PRAMP:FDELay on page 1075

**Attenuation**

Determines the level by that the average signal level is attenuated during the signal attenuation period, while the "Lev\_Att" signal is high. See also [Figure 5-3](#).

For information about the required control signal, refer to ["Power ramping and level attenuation"](#) on page 229.

Remote command:

`[ :SOURce<hw> ] :BB:DM:PRAMp:ATTenuation` on page 1075

**In Baseband Only**

Restricts power ramping to the baseband signal.

"Off" Level attenuation is affected via the attenuator stages in the RF section; only the remaining part is attenuated in the baseband. The signal is issued at the RF output with the defined level values.

"On" Level attenuation is affected in the baseband only.

**Note:**

This setting is mandatory in the following cases:

- When only the baseband signal is issued at the I/Q outputs  
It is thus ensured that, with power ramping active, this signal is output with the defined level values.
- For two-path instruments, when one baseband signal is applied to two RF paths.

Remote command:

`[ :SOURce<hw> ] :BB:DM:PRAMp:BBONly [ :STATe ]` on page 1076

**5.6.3.7 Data list editor**

The R&S SMW200A provides the following ways to create a data list file:

- To use the dedicated "Data List Editor" and create a file with extension `*.dm_iqd`, see ["To create data lists manually"](#) on page 290
- To use the tag-oriented format and create a data list file, see ["To create a data list with tag file format"](#) on page 334.
- To use SCPI commands and create a file in binary format, see ["To create a data list in binary format"](#) on page 334.

Access:

1. Select "Baseband > Custom Digital Mod > Data Source > Data List".
2. Select "Select Data List".
3. Navigate to the required directory.
4. Select "New".
5. Enter a filename.

For example, in the directory `/var/user/`, enter "Filename" = `dl_3gpp`

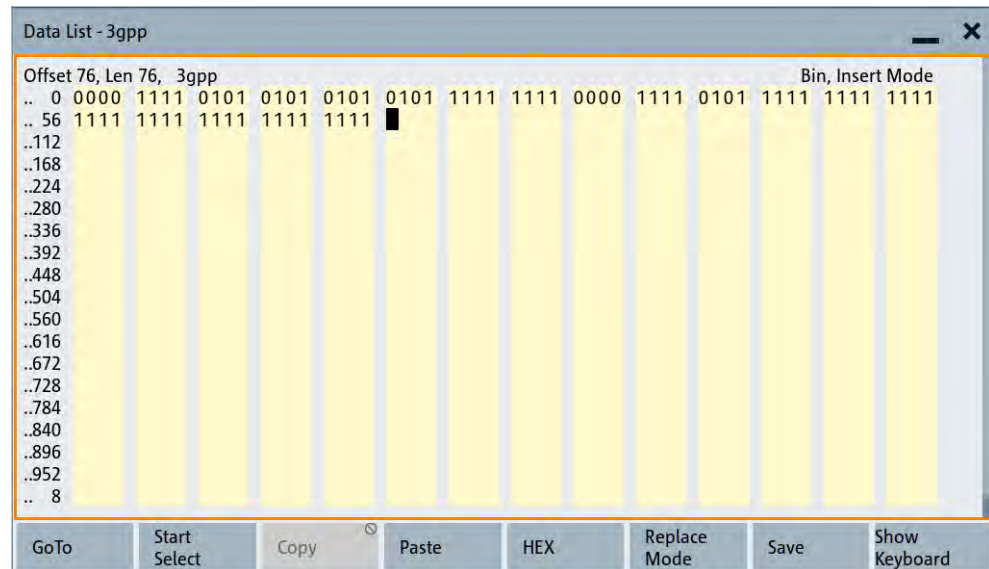

The "Data List Editor" is a list of binary values with a maximum length of  $2^{31}$  bits. This value corresponds to a file size of approx. 268 Mbyte.

To increase readability, the bits are displayed in groups of four (binary format) or two (hexadecimal format). Also, above the list are displayed: The current cursor position and the length of the list and the list filename are displayed above the list. The offset starts with the value 0 which corresponds to the bit position on the left side of the first row, i.e. the beginning of the list. On the left edge of the editor, the last three offset positions are specified at the beginning of the row.

An existing list can be edited in the insert or replace mode. The upper right corner shows the current mode.

SCPI command:

`[ :SOURce<hw> ] :BB:DM:DLIST:SELEct` on page 1087

`[ :SOURce<hw> ] :BB:DM:DLIST:DATA` on page 1091

`[ :SOURce<hw> ] :BB:DM:DLIST:DATA:APPend` on page 1092

The buttons below the binary list simplify the editing.

### Settings:

<a href="#">GoTo</a> .....	283
<a href="#">Start Select/Undo Select</a> .....	284
<a href="#">Copy, Cut, Paste</a> .....	284
<a href="#">BIN/HEX</a> .....	284
<a href="#">Replace Mode/Insert Mode</a> .....	284
<a href="#">Save</a> .....	284

### GoTo

Opens the entry window for the bit position. The cursor marks the bit at the selected position.

**Start Select/Undo Select**

Defines the current cursor position as the start position for the range to be selected. To define the stop position, select "GoTo > Go To Offset" and define the offset.

Selecting "Undo Select" deactivates the selected range.

**Copy, Cut, Paste**

Standard copy, cut, and paste functions.

**BIN/HEX**

Switches between hexadecimal and binary display.

Every 4-bit group is displayed as a hexadecimal value. To increase readability, the hexadecimal values in turn are displayed in pairs of two.

The hex functions are automatically assigned to the numeric keys at the front panel.

**Replace Mode/Insert Mode**

Switches between replace and insert mode to enter new or replace old values.

**Save**

Saves the changes into the selected data list file.

**5.6.3.8 Control and marker lists editor**

The R&S SMW200A provides the following ways to create a file containing control signals:

- To use the tag-oriented format and create a control list file, see ["To create a control list with tag file format"](#) on page 332.
- To use SCPI commands and create a file in binary format, see ["To create a control list in binary format"](#) on page 333.
- To use the dedicated "Control Data Editor" and create a file in ASCII format and with an extension `*.dm_iqc`.  
The "Control Data Editor" is described in this section. Refer to ["To create a control list in ASCII format manually"](#) on page 288 for step-by-step instructions.

**To access the "Control Data Editor"**

1. Select "Baseband" > "Custom Digital Mod" > "Data Source".
2. Select "Select Control List".
3. Navigate to the required directory, for example `/var/user/`.
4. Select "New".
5. In the "Filename" field, enter the name of the new control list, for example `dl_3gpp`.

## 6. Select "Edit".

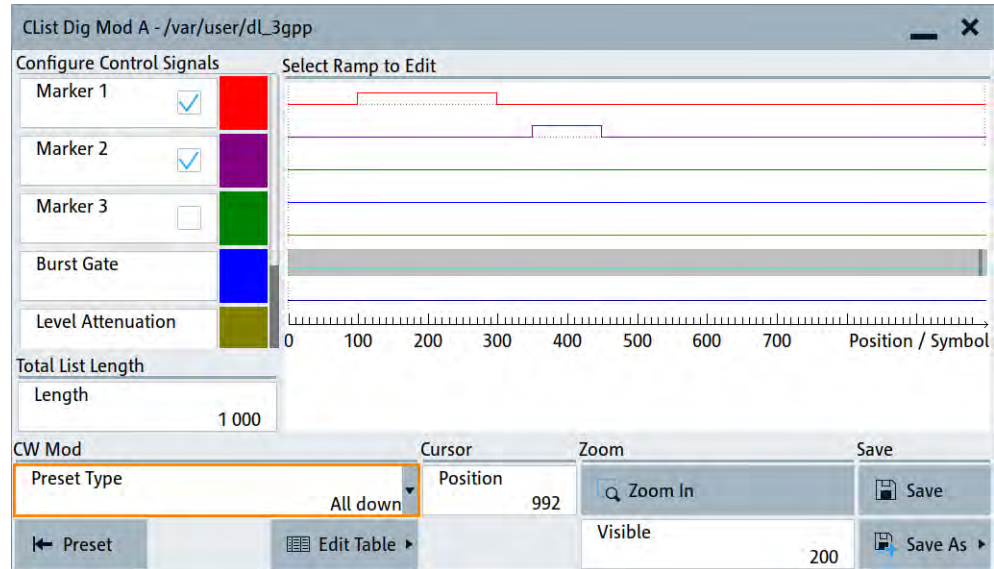

The dedicated internal "Control Data Editor" is an intuitive graphical interface provided for defining and managing of:

- Marker signals
- Control signals, like the CW, "Hop", "Burst Gate", and "Lev\_Att" control signals  
See also [Section 5.5.1.3, "About control signals"](#), on page 229.

A separate file with the file extension `*.dm_iqc` is created for each defined control signal and held on the instrument's hard disk. Control lists created with the editor are files in an ASCII file format.

In the "Control Data Editor" dialog, the available marker and control signals are displayed color-coded. The "Select Ramp to Edit" is a graphical display of the signal characteristics. To define the ramp for the individual markers or control signals, tap on the desired position or use the provided support functions "<Signal> Table" and "Cursor Position". To simplify the settings, use the predefined preset ramp characteristics in the "<Signal> Preset Type" section. The scaling of the x-axis is always adapted to the overall length of the control list to provide a constant overview of all defined ramps. For detailed representation, zoom the displayed area around the current cursor position.

In the "Configure Control Signal" section, a status checkbox indicates whether the individual marker or control signal is assigned or enabled (see [Section 5.6.4.1, "How to create and assign a control list"](#), on page 288).

SCPI command:

`[ :SOURce<hw> ] :BB:DM:CLIST:CATalog?` on page 1086

`[ :SOURce<hw> ] :BB:DM:CLIST:SElect` on page 1087

**Settings:**

<a href="#">Configure Control Signal</a> .....	286
<a href="#">Select Ramp to Edit</a> .....	286
<a href="#">Total List Length</a> .....	286
<a href="#">Preset Type</a> .....	286
<a href="#">Cursor Position</a> .....	287

Positions Control Signal.....	287
Zoom/Visible.....	287
Save/Save As.....	287

### Configure Control Signal

Displays the color the marker/control signal has been assigned.

The status checkbox indicates whether the individual marker or control signal is assigned or enabled (see [Section 5.6.4.1, "How to create and assign a control list"](#), on page 288).

Remote command:

n.a.

### Select Ramp to Edit

Graphical representation for editing of the marker/control signals.

Refer to [Section 5.6.4.1, "How to create and assign a control list"](#), on page 288 for an overview of the editing capabilities of the display.

Remote command:

```
{[TRACE] LIST [#]: Pos0:State0; Pos1:State1; ...PosN-1:StateN-1}
```

on page 343

```
[ :SOURce<hw> ] :BB:DM:CLIST:DATA on page 1090
```

### Total List Length

Enters the length of the definition range of the control list in bits. The starting value is always bit 0. The entire definition range is displayed, i.e. the bit scale is adapted to the entry. If the definition range is decreased, the ramps outside the range are lost.

When used, the control list is always repeated over the length of the definition range if the length of the data list exceeds the length of the control list.

**Tip:** With long control lists, it is useful to zoom the displayed area around the current cursor position ("Zoom in").

Remote command:

```
{CONTROL LENGTH: ControlLength} on page 339
```

### Preset Type

Triggered with "Preset", presets for the ramp characteristic of the selected control signal as defined with the "Preset Type".

"All Up, All Down"

Continuously high/low marker/control signal.

"Ramp Up, Ramp Down"

A ramp from low to high or from high to low is configured in the center of the displayed signal area; the ramp position can be later shifted as required.

"Ramp Up/Down, Ramp Down/Up"

Created is a ramp sequence of low to high and high to low transitions, respectively high to low, and low to high transitions. The ramps are symmetrically distributed around the center of the displayed signal area but can be later shifted as required.

Remote command:

n.a.

### Cursor Position

Displays/enters the cursor position in the graphical display

If the entered value exceeds the selected length of the definition range, the length is adjusted automatically.

Remote command:

n.a.

### Positions Control Signal

Select "Edit ..." to access a dialog with a representation of the ramps of the selected signal in table form.

	Ramp Position	Ramp State
0	0	Low
1	82	High
2	284	Low
3	0	
4		

✓ Accept

The bit position is specified in the "Ramp Position" column, the high or low signal status in the "Ramp State" column. Use the last blank row to enter the new ramps.

To apply the changes, press "Accept".

Remote command:

n.a.

### Zoom/Visible

Zooms the displayed area of the control list. The designation of the button changes from "Zoom in" to "Zoom out".

With long control lists, it is helpful to display only a part of the control list. In such cases, set the "Visible/Bits Visible" to determine the number of symbols/bits to be displayed and select "Zoom" to focus the displayed area around the current "Cursor Position".

Ramps outside the displayed area are not lost by zooming.

Remote command:

n.a.

### Save/Save As

Saves the changes in the selected control list file or in a new file.

Remote command:

n.a.

## 5.6.4 Creating data and control lists

This section provides step-by-step instructions on configuring and using the provided settings. For details on individual functions and settings, see [Section 5.6.3, "Custom digital modulation settings"](#), on page 267.

### To generate a digitally modulated signal

- ▶ To generate a simple 3GPP digitally modulated signal, follow the instructions in [Section 3.3.2, "Generating a digitally modulated signal"](#), on page 56.

### To apply an external clock signal



### Internal and external clock synchronization

The correct synchronization of the internal clock synthesizer requires that the following procedure is maintained.

1. Supply the instrument with the external clock, i.e. connect the external reference clock source to the suitable instrument's connector.
2. If necessary, adjust the corresponding connector settings.
3. Adjust the "Symbol Rate".  
The selected symbol rate must not deviate from the symbol rate of the external signal by more than 2 %.
4. Enable "Clock Source External".

For more information, refer to the specifications document.

### 5.6.4.1 How to create and assign a control list

The R&S SMW200A provides the following ways to create a file containing control signals:

- To use the dedicated [Control and marker lists editor](#) and create a file in ASCII format and with an extension \*.dm\_iqc, see ["To create a control list in ASCII format manually"](#) on page 288
- To use the tag-oriented format and create a control list file, see ["To create a control list with tag file format"](#) on page 332.
- To use SCPI commands and create a file in binary format, see ["To create a control list in binary format"](#) on page 333.

### To create a control list in ASCII format manually

Use the intuitive build in [Control and marker lists editor](#) dialog:

1. To open the "Control Data Editor":
  - a) Select "Baseband" > "Custom Digital Mod" > "Data Source" > "Select Control List".



- b) Select a file.  
You can select an existing file or a "New".

If the selected file is an existing one, the dialog shows the used settings. If you create a file, the control list is empty.

2. Adjust the control signals as required.
  - a) In the graphic editor "Select Ramp to Edit", select the color-coded trace of the required signal.
  - b) Tap at a position which requires a ramp. The number or ramps per marker is unlimited.
  - c) To remove a ramp, place the cursor at the desired ramp position. Press the [Backspace] key.
  - d) For faster marker and control signal definition, use the predefined ramp functions ("Preset Type"). Apply them with "Preset".
  - e) If necessary, readjust the ramps with the help of the "Edit Table" function.
  - f) Define the "Total List Length".
  - g) To display only a part of the control list, set the "Visible/Bits Visible" to determine the number of displayed symbols/bits.  
Select "Zoom" to focus the displayed area around the current "Cursor Position".

Ramps outside the displayed area are not lost.

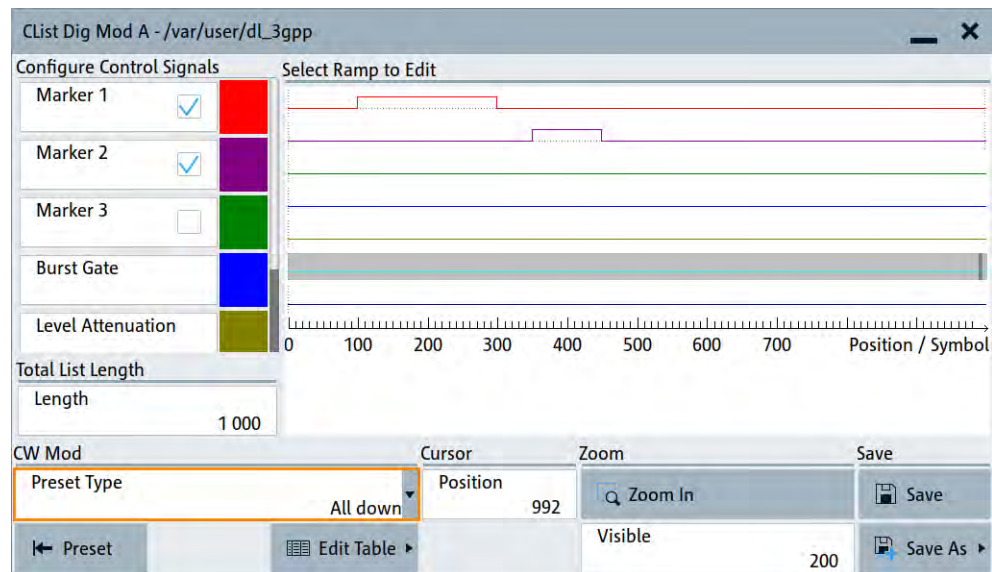

Figure 5-16: Example of control list settings

3. Select "Save" or "Save As" to save the used settings as a control list file.

The created file is an ASCII file with the extension \*.dm\_iqc.

Enable the instrument to use the control list, e.g. for the marker and/or other control signals.

Enabled control signals are indicated as active in the "Configure Control Signal" section.

### To assign and activate control signals from a control list

Irrespective of the way they are created, generated control lists are not automatically used. To use a marker signal or a control signal from a control list and to output this signal at the supported connector, proceed as follows:

1. Enable the R&S SMW200A to use the control list for marker output 2.  
Output this signal at the T/M2 connector:
  - a) Select "Baseband" > "Custom Digital Mod" > "Marker".
  - b) Select "Marker 2" > "Mode" > "CList".
  - c) Select "Baseband" > "Custom Digital Mod" > "Marker" > "Local Connectors".
  - d) Select "Routing" > "T/M 2" > "Direction" > "Output".  
The output signal is "Signal" > "Baseband A Marker 2".
2. To enable the R&S SMW200A to use the "Burst Gate" and "Level Attenuation" control signals as defined in a control list and output one of them at the T/M3 connector:
  - a) Select "Baseband" > "Custom Digital Mod" > "Power Ramp Control" > "Source" > "Internal".
  - b) Select "Baseband" > "Custom Digital Mod" > "Marker" > "Local Connectors".
  - c) Select "Routing" > "T/M 3" > "Direction" > "Output".  
The output signal is "Signal" > "Lev Att A".

#### 5.6.4.2 How to create and assign a data list

The R&S SMW200A provides the following ways to create a data list file:

- To use the dedicated [Data list editor](#) and create a file with extension `*.dm_iqd`, see ["To create data lists manually"](#) on page 290
- To use the tag-oriented format and create a data list file, see ["To create a data list with tag file format"](#) on page 334.
- To use SCPI commands and create a file in binary format, see ["To create a data list in binary format"](#) on page 334.

#### To create data lists manually

Use the intuitive build in [Data list editor](#) dialog:

1. To access the "Data List Editor":
  - a) Select "Baseband" > "Custom Digital Mod".
  - b) Select "Data Source" > "Data List".
  - c) Select "Select Data List"
  - d) Navigate to the required directory, for example `/var/user/`.
  - e) Select "New". Enter a filename, for example `dl`.  
The "Data List Editor" opens; the data list is empty.
2. Enter a sequence of 0 and 1, for example `01110101`.

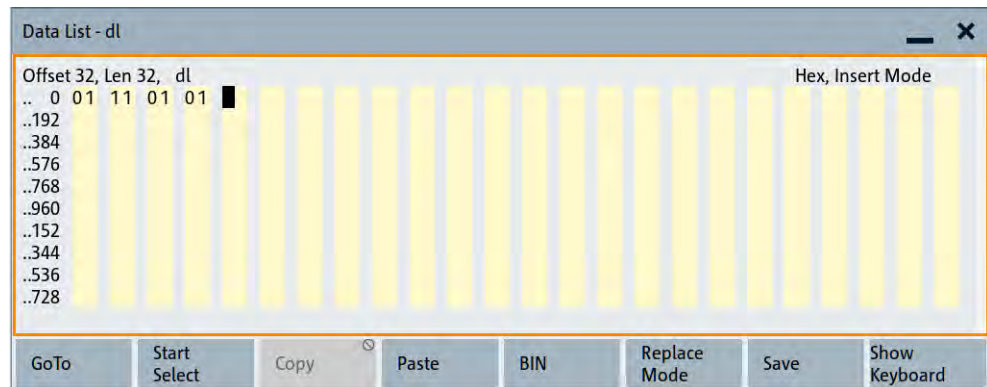

Figure 5-17: Example of data list

3. Select "Save" to save the used settings as a data list file.  
The instrument saves the `dl.dm_iqd` file in the `/var/user/` directory.

### How to assign and activate data lists

Irrespectively on the way they are created, generated data lists are not automatically used.

1. To enable the R&S SMW200A to use the data list as a data source for the custom digital modulation:
  - a) Select "Baseband" > "Custom Digital Mod".
  - b) Select "Data Source" > "Data List".
  - c) Select "Select Data List"
  - d) Navigate through the file system.
  - e) To select the file, confirm with "Select".
2. To enable the R&S SMW200A to use the data list as a data source for any of the digital standards:
  - a) Select the "Data List Name" in the individual dialog.  
For example, for "Baseband" > "3GPP FDD" > "Basestations" > "BS1" > "Channel Table" > "P-CCPCH" > "Data" > "Data List".
  - b) Select "DList" > "None".
  - c) Select the file in the file system.

## 5.6.5 References

This section provides reference information on common custom digital modulation characteristics including default settings and predefined settings. It covers the following topics:

- [Default settings and predefined configurations](#)..... 292
- [Common coding algorithms](#)..... 295
- [Predefined baseband filters](#)..... 297

### 5.6.5.1 Default settings and predefined configurations

**Table 5-11: Custom digital modulation default settings**

Settings	Parameter	Value
"General"	"State"	Not affected
	"Standard"	"GSM"
	"Symbol Rate"	"270.833333 ksym/s"
	"Coding"	"GSM"
"Data Source"	"Data Source"	"PRBS"
	"PRBS Type"	"PRBS 9"
"Modulation"	"Modulation Type"	"MSK"
"Filter"	"Filter"	"Gauss (FSK)"
	"B*T"	"0.30"
"Trigger In"	"Mode"	"Auto"
	"Source"	"Internal"
"Marker"	"Mode"	"On/Off Ratio"
"Clock"	"Clock Source"	"Internal"
"Power Ramp Control"	"State"	"Off"
	"Source"	"Internal"
	"Ramp Function"	"Cosine"
	"Ramp Time"	"1.00 sym"
	"Rise Delay"	"0.00 sym"
	"Fall Delay"	"0.00 sym"
	"Attenuation"	"15.0 dB"

**Table 5-12: Predefined settings for communication standards**

Standard	Modulation	Symbol rate	Filter	Coding	SCPI filter type
APCO Phase1 C4FM	4FSK $f_{dev} = 1.8 \text{ kHz}$	4.8 ksym/s	APCO25 Rolloff factor = 0.2	APCO25(FSK)	APCOPH1C4fm
APCO Phase1 CQPSK	pi/4-DQPSK	4.8 ksym/s	Raised Cosine Rolloff factor = 0.2 Bandwidth = 4.8 kHz	APCO25(PSK)	APCOPH1CQpsk
APCO Phase2 H- CPM	4FSK $f_{dev} = 3 \text{ kHz}$	6 ksym/s	APCO25(H-CPM)	APCO25(FSK)	APCOPH2HCpm
APCO Phase2 H- DQPSK	pi/4-DQPSK	6 ksym/s	Raised Cosine Rolloff factor = 1 Bandwidth = 7.2 kHz	APCO25(PSK)	APCOPH2HDQpsk
APCO Phase2 H- D8PSK Wide	pi/8-D8PSK	4 ksym/s	Raised Cosine Rolloff factor = 1 Bandwidth = 7.2 kHz	APCO25(8PSK)	APCOPH2HD8PSKW

Standard	Modulation	Symbol rate	Filter	Coding	SCPI filter type
APCO Phase2 H-D8PSK Narrow	pi/8-D8PSK	4 ksym/s	Raised Cosine Rolloff factor = 1 Bandwidth = 5 kHz	APCO25(8PSK)	APCOPH2HD8PSKN
APCO Phase1 LSM	pi/4-DQPSK	4.8 ksym/s	APCO25(LSM) Gauss Cut Off Freq. = 2.04 kHz Lowpass Cut Off Freq. = 6.2 kHz	APCO25(PSK)	APCOPH1Lsm
APCO Phase1 WCQPSK	pi/4-DQPSK	4.8 ksym/s	Raised Cosine Rolloff factor = 1 Bandwidth = 7.2 kHz	APCO25(PSK)	APCOPH1Wcqpsk
Bluetooth	2FSK $f_{dev} = 160$ kHz	1 Msym/s	Gauss (FSK) $B*T = 0.5$	Off	BLUetooth
CDMA2000 Forward	QPSK	1.2288 Msym/s	cdmaOne + Equalizer	cdma2000	CFORward
CDMA2000 Reverse	Offset QPSK	1.2288 Msym/s	cdmaOne	cdma2000	CREVerse
CW in Baseband	BPSK	1 Msym/s	Gauss (FSK) $B*T = 0.5$	Off	CWBPsK
DECT	2FSK $f_{dev} = 288$ kHz	1.152 Msym/s	Gauss (FSK) $B*T = 0.5$	Off	DECT
ETC	ASK $m = 100$ %	1.024 Msym/s	Split Phase $B*T = 2.0$	Off	ETC
GSM	MSK	270.833333 ksym/s	Gauss (FSK) $B*T = 0.3$	GSM	GSM
GSM EDGE	8PSK EDGE (3pi/8 8PSK)	270.833333 ksym/s	Gauss Linearized	Off	GSMEdge
NADC	pi/4 DQPSK	24.3 ksym/s	Root Raised Cosine Rolloff factor = 0.35	NADC	NADC
PDC	pi/4 DQPSK	21 ksym/s	Root Raised Cosine Rolloff factor = 0.5	PDC	PDC
PHS	pi/4 DQPSK	192 ksym/s	Root Raised Cosine Rolloff factor = 0.5	PHS	PHS
TD-SCDMA	QPSK 45° Offset	1.28 Msym/s	Root Raised Cosine Rolloff factor = 0.22	Off	TCSCdma
Telemetry SOQPSK-TG	2FSK $f_{dev} = 1.25$ MHz	5 Msym/s	SOQPSK	Off	SOQPSKTG
TETRA	pi/4 DQPSK	18 ksym/s	Root Raised Cosine Rolloff factor = 0.35	TETRA	TETRa
TFTS	pi/4 DQPSK	22.1 ksym/s	Root Raised Cosine Rolloff factor = 0.4	TFTS/TETRA	TFTS

Standard	Modulation	Symbol rate	Filter	Coding	SCPI filter type
WCDMA-3GPP	QPSK 45° Offset	3.84 Msym/s	Root Raised Cosine Rolloff factor = 0.22	WCDMA 3GPP	W3GPP
Worldspace	QPSK	1.84 Msym/s	Root Raised Cosine Rolloff factor = 0.4	Off	WORLdspace

Table 5-13: Modulation type and coding combinations

Modulation	Coding	Modulation	Coding
ASK	Off Differential, Differential + Gray, Gray	pi/8 D8PSK	Off Gray APCO25(8PSK)
BPSK, AQPSK, OQPSK	Off Differential, Differential + Gray, Gray	8PSK	Off Differential, Differential + Gray, Gray VDL
QPSK	Off Differential, Differential + Gray, Gray INMARSAT, ICO, CDMA2000, WCDMA INMARSAT for R&S SMW- B10 only	16QAM, 32QAM, 64QAM, 128QAM, 256QAM, 512QAM, 1024QAM	Off Differential, Phase Differential, Differential + Gray, Gray Phase Differential for R&S SMW-B10 only
QPSK 45° Offset	Off Differential, Differential + Gray, Gray ICO, CDMA2000, WCDMA	MSK, 2 FSK	Off Differential, Differential + Gray, Gray GSM
QPSK EDGE, 8PSK EDGE, 16QAM EDGE, 32QAM EDGE	Off	4FSK, Variable FSK > 4FSK	Off Differential, Differential + Gray, Gray APCO25(FSK)
OQPSK	Off Differential, Differential + Gray, Gray INMARSAT, ICO, CDMA2000, WCDMA INMARSAT for R&S SMW- B10 only	8FSK, 16FSK, 32FSK, 64FSK	Off
pi/4 QPSK	Off Differential, Gray	Variable FSK > 8FSK, Variable FSK > 16FSK	Off Differential, Differential + Gray, Gray

Modulation	Coding	Modulation	Coding
pi/2 DBPSK	Off Gray	16APSK, 32APSK	Off
pi/4 DQPSK	Off Gray NADC, PDC, PHS, TETRA APCO25(PSK), PWT, TFTS/ TETRA	User	Off

### 5.6.5.2 Common coding algorithms

#### Coding notation

In the notation used below,  $a_n$  denotes the  $n^{\text{th}}$  input symbol and  $b_n$  denotes the correspondingly coded output symbol. Individual bits in the symbols from the LSB (least significant bit) to the MSB (most significant bit) are denoted by  $a_{0n}$ ,  $a_{1n}$ , etc. The same applies to the output symbols.

The table [Table 5-14](#) lists common coding types and coding algorithms.

**Table 5-14: Coding types and coding algorithms**

Coding	Coding algorithm	Bit per symbol
"None"	$b_n = a_n$	$k = 1$ to 8
"Differential"	$b_n = (a_n + b_{-1}) \text{ modulo } 2^k$	$k = 1$ to 7
"Differential + Gray"	Gray coding with additional differential coding	$k = 1$ to 7
"GSM" <sup>1)</sup>	$d_n = \text{NOT} (d_n \text{ EXOR } d_{-1})$	$k = 1$
"Phase Differential" <sup>1)</sup>	$b_{1n} = [\text{NOT} (a_{1n} \text{ EXOR } a_{0n}) \text{ AND } (a_{1n} \text{ EXOR } b_{1(n-1)})] \text{ OR } [(a_{1n} \text{ EXOR } a_{0n}) \text{ AND } (a_{1n} \text{ EXOR } b_{0(n-1)})]$ $b_{0n} = [\text{NOT} (a_{1n} \text{ EXOR } a_{0n}) \text{ AND } (a_{0n} \text{ EXOR } b_{0(n-1)})] \text{ OR } [(a_{1n} \text{ EXOR } a_{0(n-1)}) \text{ AND } (a_{0n} \text{ EXOR } b_{1(n-1)})]$	-

<sup>1)</sup> Requires R&S SMW-B10.

"Coding" > "INMARSAT" or "Phase Differential" corresponds to system standards Inmarsat-M and DVB according to ETS 300 429. You can use INMARSAT coding for modulation types with 2 bit/symbol coding, such as QPSK.

#### Examples

The following examples illustrate how some of the coding schemes and modulation type influence the signal.

**Example: Differential coding for QPSK modulation with  $k = 2$  bits per symbol**

Decimal display; the value range for modulation symbols is  $a_n = \{0, 1, 2, 3\}$ .

According to [Table 5-14](#) and for  $k = 2$ , the recursive coding is as follows:

$$b_n = (a_n + b_{-1}) \text{ modulo } 4.$$

Depending on the state of a preceding modulation symbol  $b_{-1}$ , the coded modulation symbol  $b_n$  is obtained, for example, from modulation symbol,  $a_n = 2$  as follows:

$b_{-1}$	0	1	2	3
$b_n$	2	3	0	1

With differential coding, the assignment of modulation symbols  $a_n$  (binary indication: MSB, LSB) to the phase differences shown in the following table is generated:

**Table 5-15: Phase difference for QPSK**

Modulation symbol $a_n$	00	01	10	11
Phase difference	0°	90°	180°	270°

**Example: Differential coding for modulation type  $\pi/4$  DQPSK**

With differential coding switched on at the same time, the obtained constellation diagram for  $\pi/4$ DQPSK is similar to that of 8PSK. Phase shifts are however assigned to the individual modulation symbols. The [Table 5-16](#) shows the assignment of modulation symbols  $a_n$  (binary indication: MSB, LSB) to phase shifts of the I/Q vector in relation to the selected coding.

**Table 5-16: Phase shifts for  $\pi/4$ DQPSK**

Modulation symbol $a_n$	00	01	10	11
"Coding" > "Off"	+ 45°	+ 135°	- 135°	- 45°
"Coding" > "NADC"/"PDC"/"PHS"/"TETRA"/"APCO25(PSK)"	+ 45°	+ 135°	- 45°	- 135°
"Coding" > "TFTS"	- 135°	+ 135°	- 45°	+ 45°

**Example: Gray and differential coding for 8PSK modulation**

When this coding scheme is used, the gray coding according to the gray code is performed before the differential coding. The later uses the recursive coding algorithm quoted above, see [Table 5-14](#). The assignment of modulation symbols  $a_n$  (binary indication: MSB, LSB) to the phase differences shown in the following table is generated:

**Table 5-17: Differential coding according to VDL<sup>1)</sup>**

Symbol $d_n$	Phase difference	Symbol $d_n$	Phase difference
000	0°	100	270°
001	45°	101	315°



Symbol $d_n$	Phase difference	Symbol $d_n$	Phase difference
010	135°	110	225°
011	90°	111	180°

1) VHF data link (VDL) coding for modulation types with 3 bits/symbol, for example 8PSK.

### 5.6.5.3 Predefined baseband filters

The Table 5-18 shows the filters that are available, together with their associated parameters. The filter characteristic is displayed in graphical form.

Table 5-18: Overview of the baseband filters

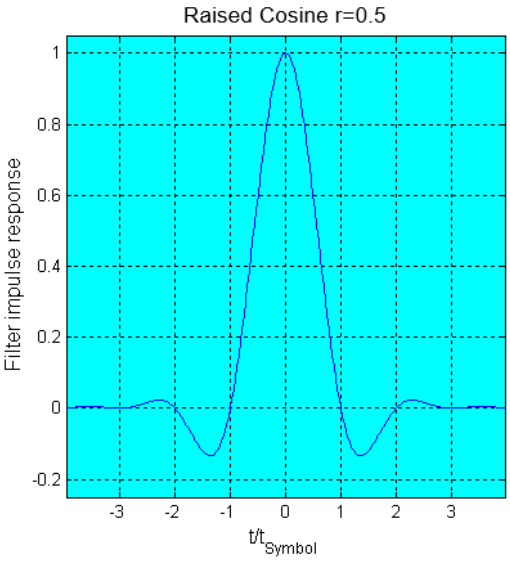
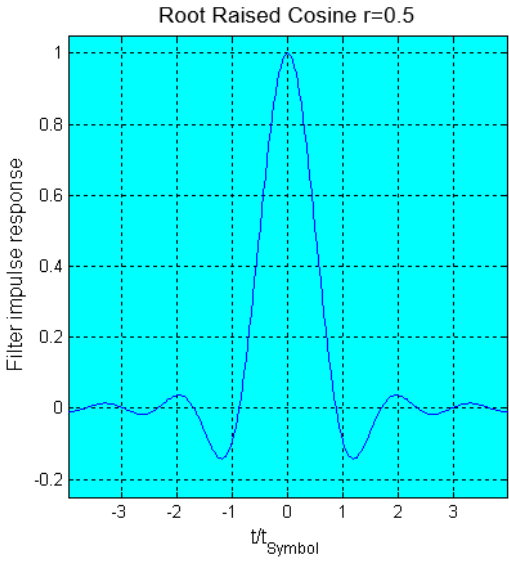
"Raised Cosine (RC)" "Roll Off Factor"	"Root Raised Cosine (RRC)" "Roll Off Factor"
	
"Gauss (FSK)" "B*T"	"Gauss (Pure)" "B*T"

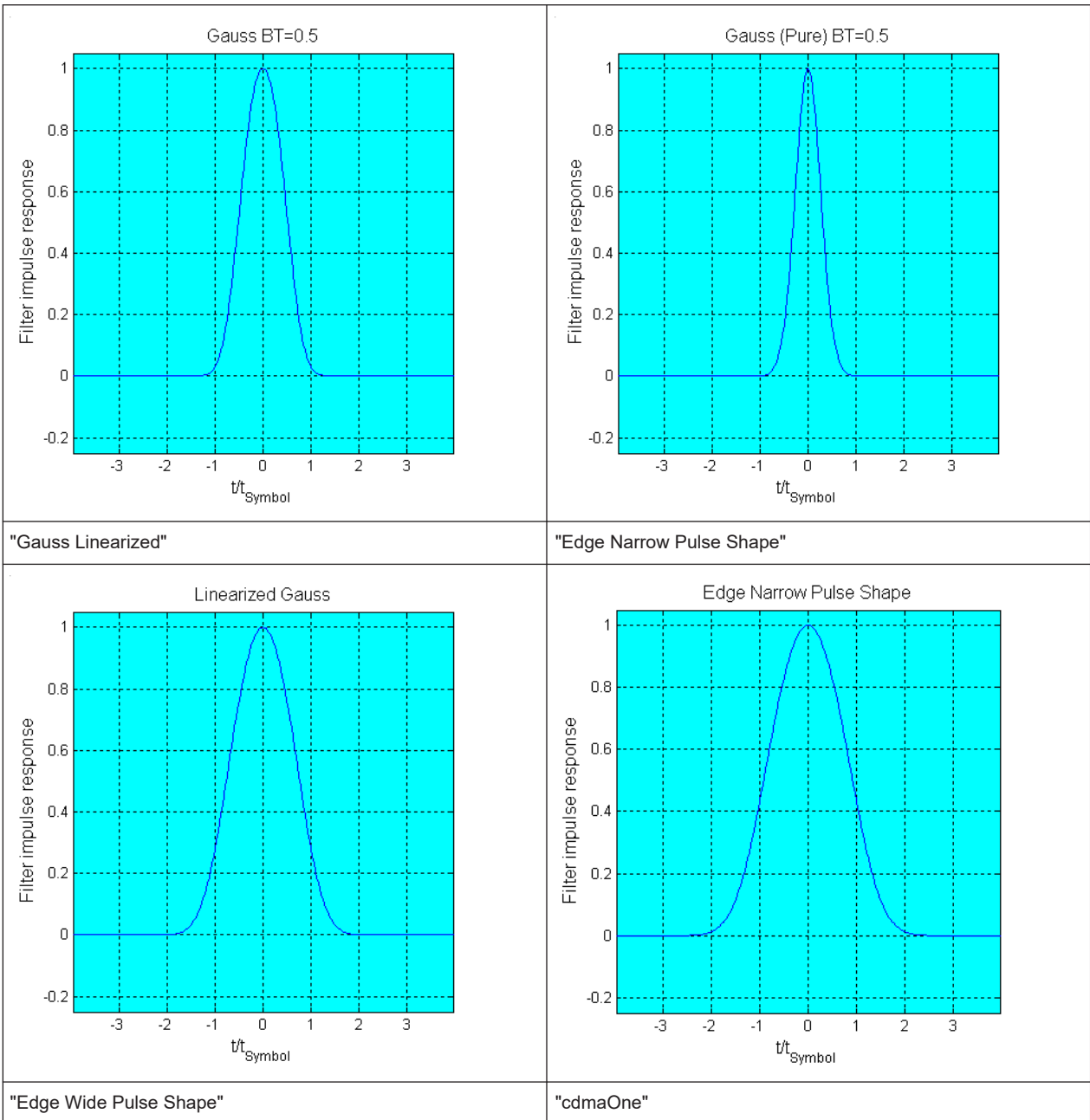

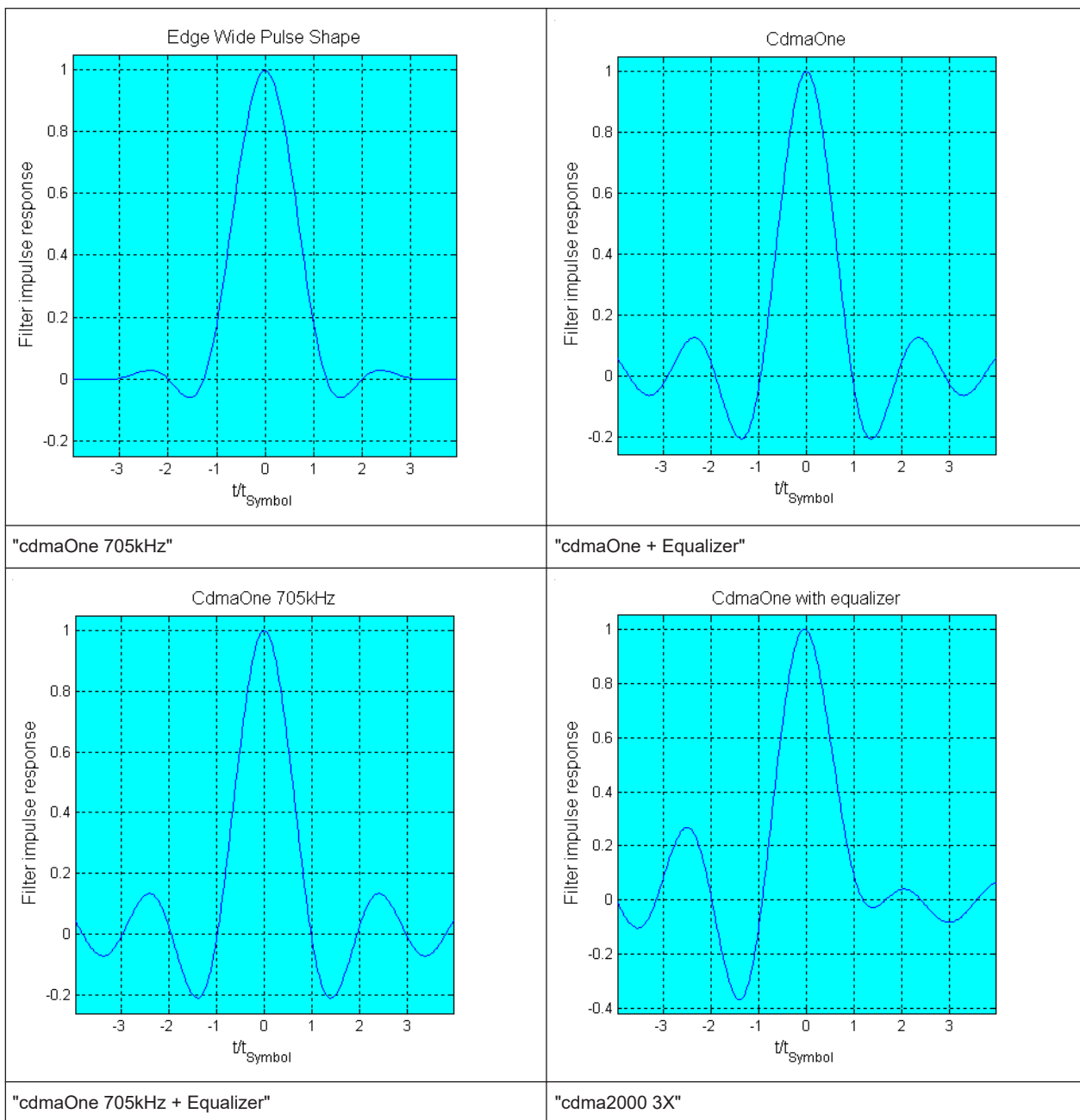

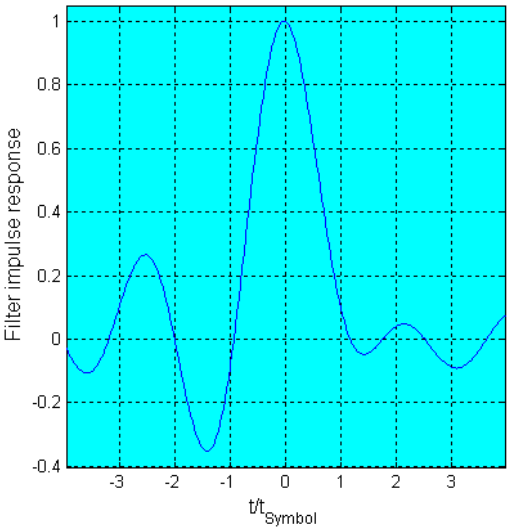
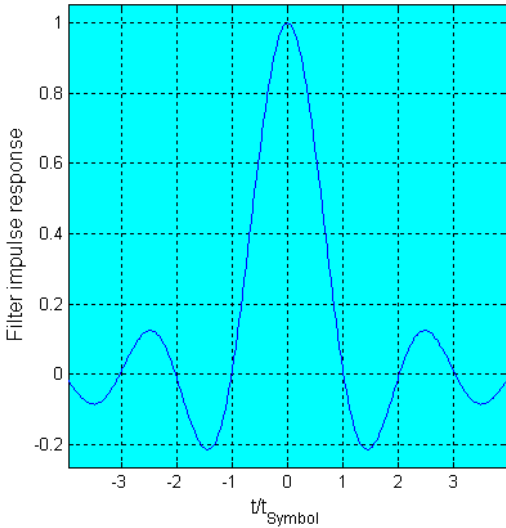
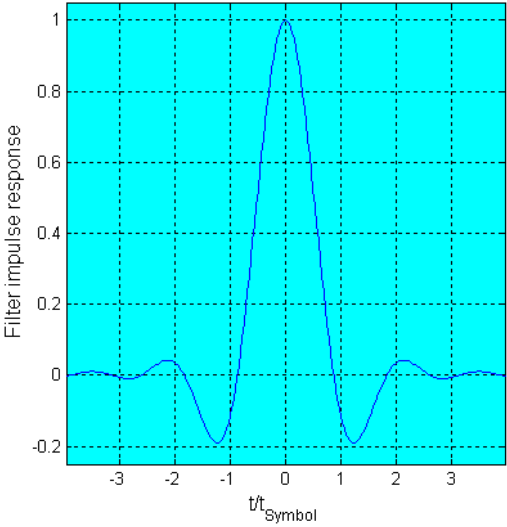
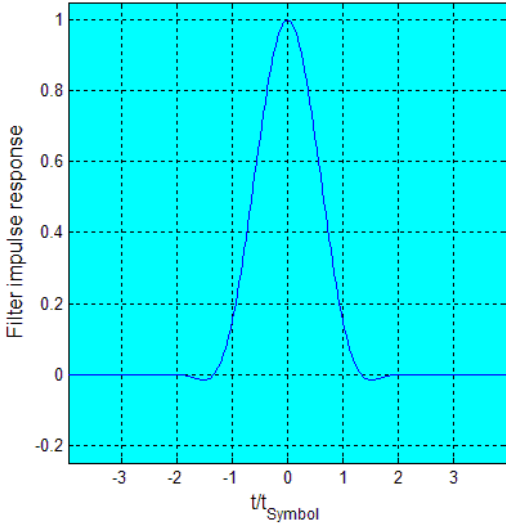
<p style="text-align: center;">CdmaOne 705 kHz with equalizer</p> 	<p style="text-align: center;">Cdma2000 3X</p> 
<p>"APCO25" "Roll Off Factor"</p>	<p>"APCO25 (H-CPM)"</p>
<p style="text-align: center;">APCO25 r=0.5</p> 	<p style="text-align: center;">APCO H-CPM</p> 
<p>"APCO25 (LSM)" "Gauss Cut Off Frequency" "Lowpass Cut Off Frequency"</p>	<p>"Split Phase" "B*T"</p>

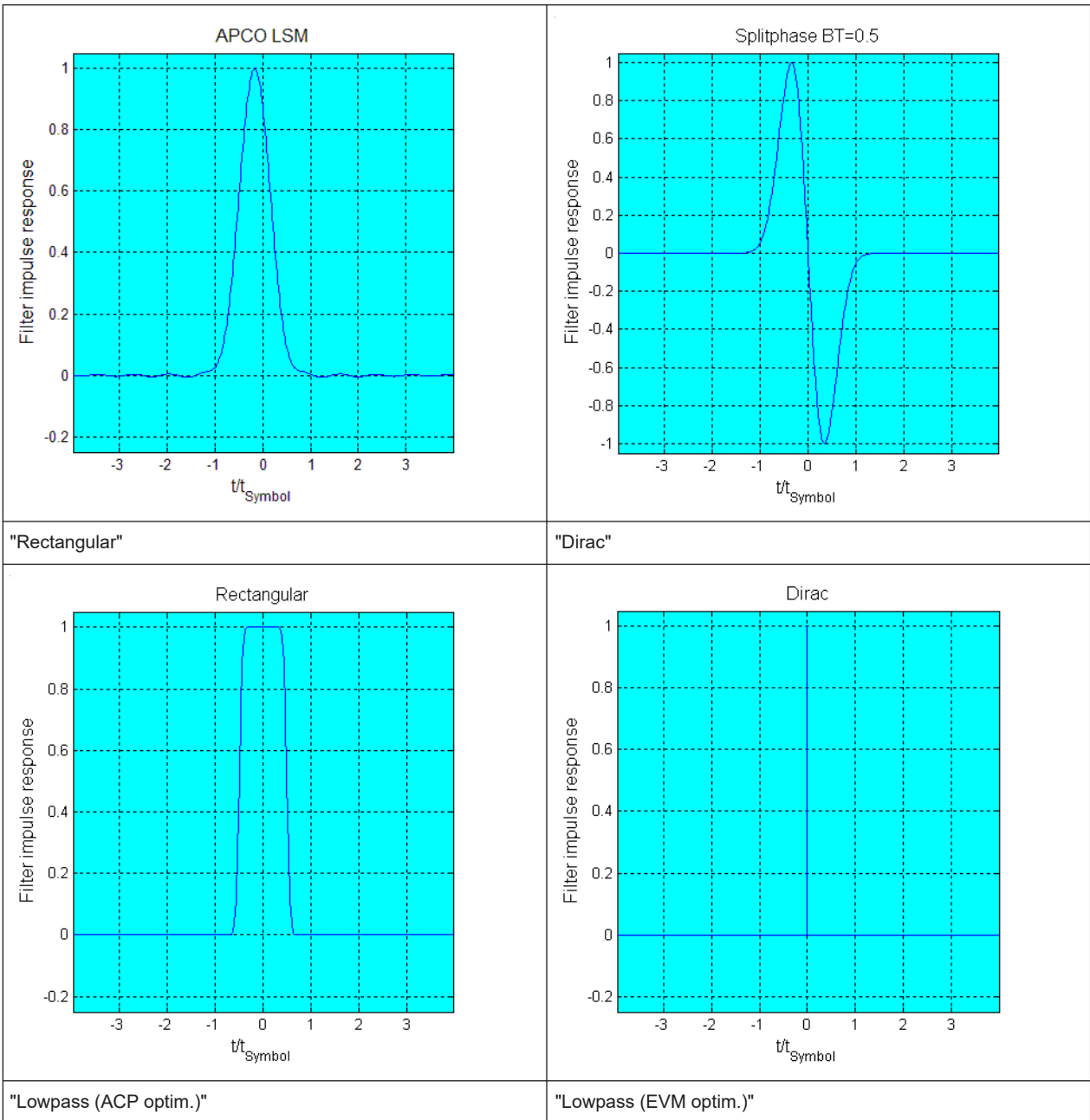

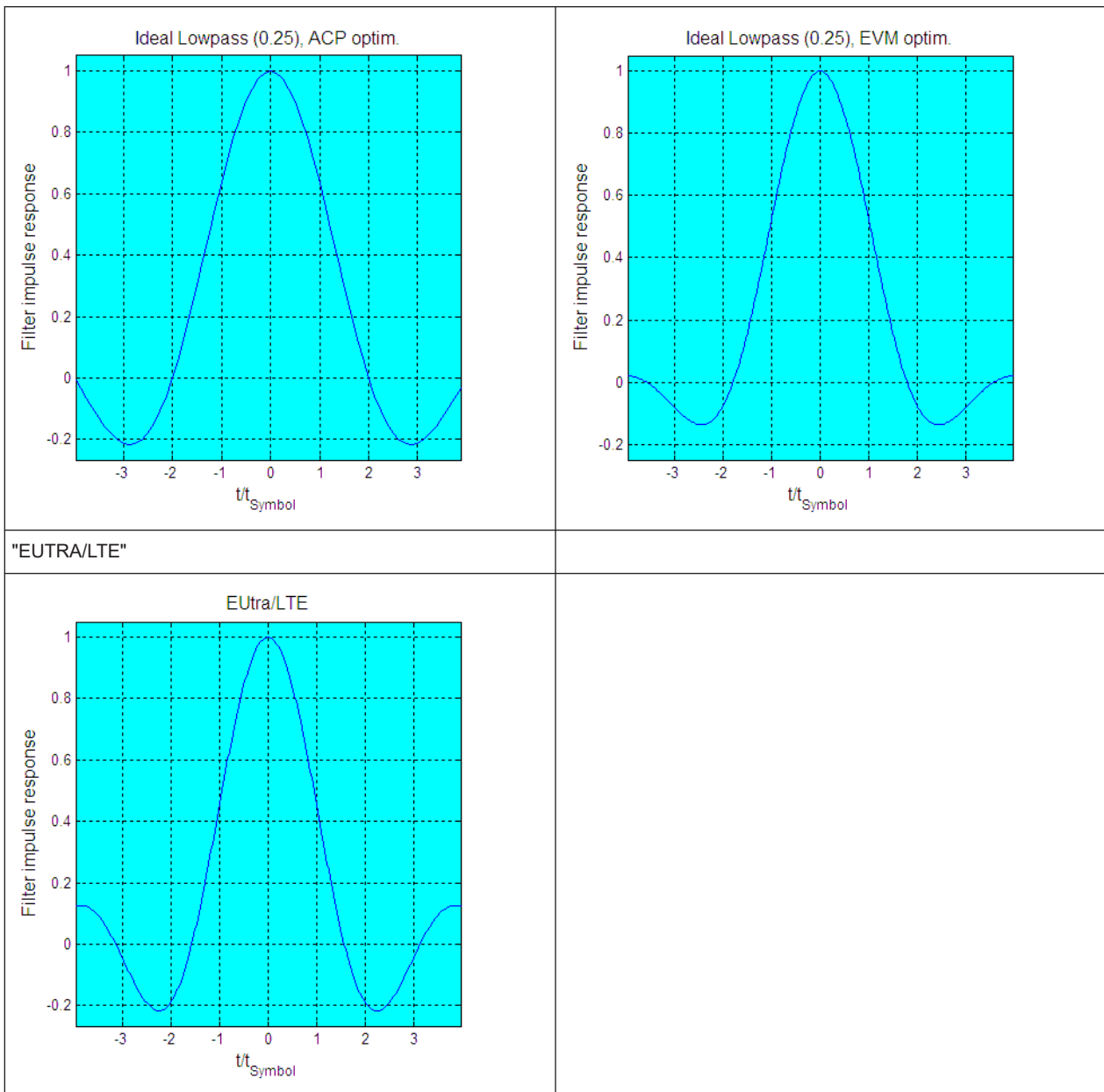

## 5.7 Using the arbitrary waveform generator (ARB)

The arbitrary waveform generator (ARB) is an I/Q modulation source of the R&S SMW200A. The ARB allows the playback and output of any externally calculated modulation signals in the form of waveform files. The ARB can also generate multicarrier or multi-segment signals from the waveform files.

• <a href="#">Required options</a> .....	303
• <a href="#">About ARB</a> .....	303
• <a href="#">ARB settings</a> .....	309
• <a href="#">Playing waveform files</a> .....	319
• <a href="#">Tags for waveforms, data and control lists</a> .....	335

### 5.7.1 Required options

The equipment layout for processing of waveform files includes:

- Standard or wideband Baseband Generator (R&S SMW-B10/-B9) per signal path  
The baseband generator includes the arbitrary waveform generator.
- Baseband main module, one/two I/Q paths to RF (R&S SMW-B13/-B13T) or Wideband baseband main module two I/Q paths to RF (R&S SMW-B13XT)
- Corresponding Digital Standard option (R&S SMW-K2xx) per signal path  
Required to process a waveform file generated by the signal generation software R&S WinIQSIM2.  
For example, if you purchase option Digital Standard EUTRA/LTE R&S SMW-K255, you can process EUTRA/LTE waveform files created by R&S WinIQSIM2.
- Corresponding R&S®Pulse Sequencer option
- Optional ARB memory extension (R&S SMW-K511/-K512)

You can output waveform signals at several connectors. Dedicated connector output requires the following options:

- Output at the RF connector requires an RF frequency option, for example, option R&S SMW-B1003.
- Output at the DIG I/Q connectors requires option R&S SMW-K18 digital baseband output per signal path.
- Output at the HS DIG I/Q connectors requires option R&S SMW-K19 digital baseband output wideband per signal path.

For more information, refer to the specifications document.

### 5.7.2 About ARB

This section provides background information on the ARB functionality and the impact of the provided settings.

For more complex waveform signals, see the following sections:

- [Section 5.11, "Generating multicarrier waveform signals"](#), on page 391
- [Section 5.10, "Generating multi-segment waveform files"](#), on page 360
- [Section 5.12, "Generating multicarrier continuous wave signals"](#), on page 408

#### Related settings

See [Section 5.7.3, "ARB settings"](#), on page 309.

### Related step-by-step descriptions

See the following sections:

- [Section 5.7.4, "Playing waveform files"](#), on page 319
- [Section 5.7.4.6, "Defining periodically repeating traces"](#), on page 331
- [Section 5.7.4.5, "Creating waveforms with tag file format"](#), on page 326
- [Section 5.7.4.7, "Creating control lists with tag file format"](#), on page 332
- [Section 5.7.4.8, "Creating data lists with tag file format"](#), on page 334
- [Section 5.7.4.9, "Editing waveform files, data and control lists"](#), on page 335

This section covers the following topics:

- [About ARB file formats](#).....304
- [About waveform files](#).....304
- [ARB test signals](#).....305
- [Waveform sample rate](#).....307
- [Marker signals and waveform length](#).....308

#### 5.7.2.1 About ARB file formats

In ARB mode, the R&S SMW200A can load and play back various file formats.

##### ARB file formats

You can load the following file formats using the "Load Waveform" function.

File format	I/Q format	Description	Max. file size
*.wv	Real and complex	Standard waveform file format, see <a href="#">Section 5.7.2.2, "About waveform files"</a> , on page 304.	Limited by internal memory
*.iq.tar	Complex	Standard Rohde & Schwarz I/Q data format, see <a href="#">R&amp;S iq-tar</a> .	13 MB to 30 MB
*.csv	Complex	Predefined *.csv file format, see <a href="#">Section D, "ARB file formats CSV and MAT"</a> , on page 1386.	13 MB to 30 MB
*.mat	Complex	MATLAB® file format.	13 MB to 30 MB

For files with extension \*.iq.tar, \*.csv and \*.mat, also the following applies:

- Load one I/Q stream per file as in the file format: `NumberOfChannels = 1`.

#### 5.7.2.2 About waveform files

The R&S SMW200A uses waveform files to obtain the digital I/Q data of the baseband signal. The R&S SMW200A can play back a waveform file from the internal storage medium but it can also generate and play back simple waveforms for test purposes.

##### What is a waveform?

A waveform is a file with a specified file format containing raw I/Q samples. Waveform files have the file extension \*.wv and contain calculated I/Q values.



When creating waveforms, the instrument inserts a waveform header at the beginning of each created ARB file. The header of the generated I/Q data files consists of tags in braces "{ }". For a detailed description, see [Section 5.7.5, "Tags for waveforms, data and control lists"](#), on page 335.

### Waveform file sources

The following waveform file sources are available:

- **Internally generated waveforms**

The ARB enables the calculation and the generation of waveform files. The ARB also provides a built-in function to create a test waveform and keep it as a file or in the RAM.

Several digital standards provide the function "Generate Waveform ...". With this function, the R&S SMW200A creates a waveform file with the current configuration of the digital standard. You can also play back these files with the ARB.

- **Externally generated or created waveforms**

The ARB processes externally created waveform files, for example:

- The waveform files generated by software R&S WinIQSIM2, the R&S ARB Toolbox or the R&S Pulse Sequencer
- A mathematical program, for example, MATLAB calculates the waveform signals. See [Section 5.7.5, "Tags for waveforms, data and control lists"](#), on page 335.

You can load the externally generated waveform files into the instrument via one of the available interfaces, for example, USB or LAN. Usually, the waveform file is saved on one of the network drives which are accessible for the operating system.

### 5.7.2.3 ARB test signals

The following test signals are available:

- **"Sine" test signal:** Two sine-wave signals with a selectable (but equal) number of samples per period and equal frequencies. When the generation is triggered, the number of samples per period, together with the frequency of the test signal, determine the ARB clock frequency: "Clock Frequency" = "Frequency" \* "Samples per Period".

**Note:** Because the resulting clock rate must not exceed the maximum ARB clock rate, the number of sample values is automatically restricted depending on the selected frequency.

The first sine signal is mapped on the I samples, the second on the Q samples.

The two signals differ by a selectable phase offset. For a -90 deg offset, the result is a unit vector in the I/Q plane, rotating counterclockwise and starting at I = 0, Q = -1. For a 0 deg offset, the I and Q samples are on the diagonal of a unit square (I(t) = Q(t)).

Using the arbitrary waveform generator (ARB)

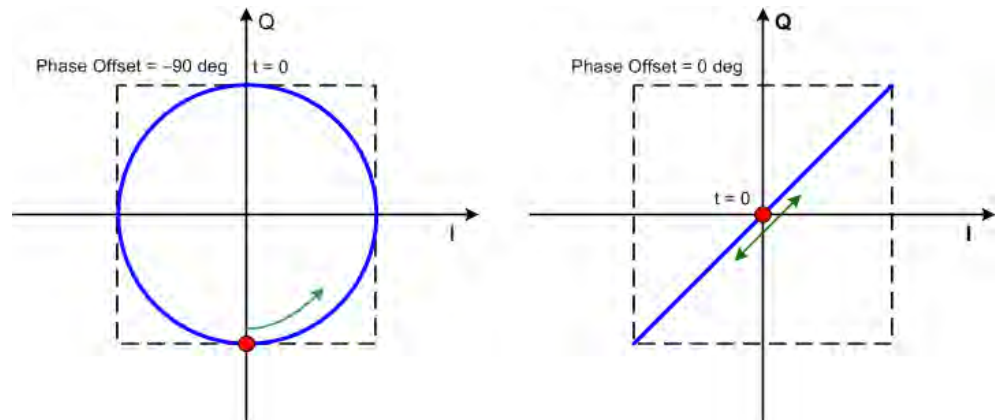

In general, the I/Q samples are located on a deformed circle which is confined to the dashed square in the upper diagrams.

- **"Rect" test signal:** Rectangle signal with selectable but equal on and off periods and amplitude. The period is defined by the selected frequency:  $\langle \text{Period} \rangle = 1 / \text{"Frequency"}$ .

The signal is mapped on both the I and Q samples. The mapping results in two distinct points in the I/Q plane. The "Offset DC" shifts both points along the diagonal  $I(t) = Q(t)$ .

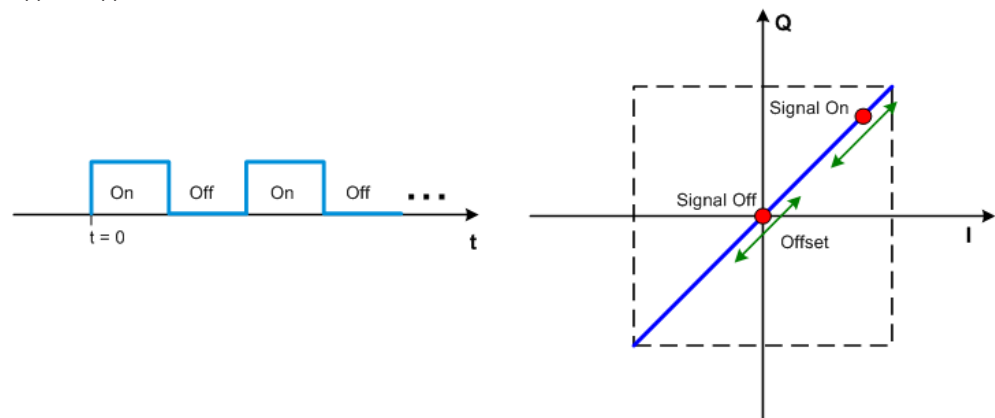

- **"Const I/Q" test signal:** Continuous test signal with constant I/Q and constant clock frequency of 10 kHz. The values for each I and Q components are selectable but constant. They are defined as a decimal number, which is decimal-to-binary converted internally. The signal is provided as a 16-bit wide digital signal for both I and Q channels.  
You can output the signal directly at the BNC connectors I and Q outputs of the instrument.
- **"AWGN" test signal:** Requires option R&S SMW-K811. Test signal comprising a noise signal. The 3 dB noise bandwidth is about 0.96 times the clock frequency. See also [Section 5.8.4, "AWGN test signal settings"](#), on page 358.

For more information, refer to the specifications document.

### 5.7.2.4 Waveform sample rate

The Arbitrary Waveform Generator includes a resampling unit that interpolates the input samples to target a certain digital output I/Q sample rate. The input sample rate  $f_{input}$  is retrieved from the waveform (the default sample rate tag) or is defined by the corresponding parameter in the ARB user interface.

The [Figure 5-18](#) depicts the stages involved in the processing and resampling of a waveform in the ARB.

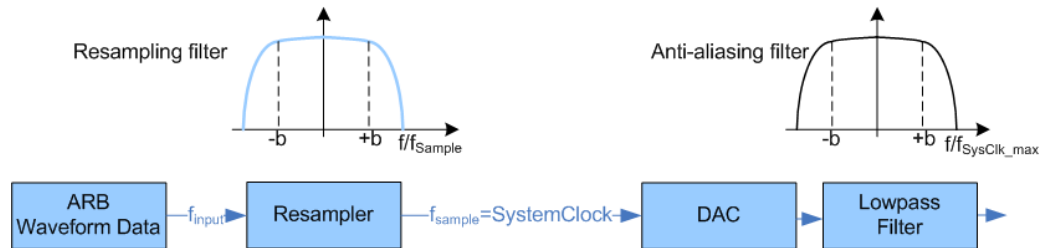

**Figure 5-18: Processing of the waveform files in the ARB**

$f_{input}$  = Waveform sample rate  
 $b$  = Usable bandwidth factor  
 $f_{SysClk\_max} = SystemClock_{max} = SampleRate_{max}$

Where:

- $f_{SysClk\_max} = SystemClock_{max} = SampleRate_{max} = 200$  MHz (R&S SMW-B10/-K522) and 2.4 GHz (R&S SMW-B9/-K527)
- $b = 0.4$  (R&S SMW-B10) and  $b = 0.4165$  (R&S SMW-B9)

#### Impact of the resampling filter

As illustrated in [Figure 5-18](#), the filter in the resampling stage is distortion-free for signals with the following maximum baseband bandwidth:

$$Usable\_Bandwidth_{max} [MHz] = b * f_{input}$$

Where  $b$  is the usable bandwidth factor and its value depends on the installed options:

- $b = 0.4$  (R&S SMW-B10)
- $b = 0.4165$  (R&S SMW-B9)

An externally created waveform file has to provide a sample rate  $f_{input}$  that is high enough for perfect signal reconstruction. For distortion-free resampling the lower bound of the required sample rate  $f_{input}$  is then calculated as follows:

$$f_{input} \geq Usable\_Bandwidth / b$$

Thus, a modulation signal with a sample rate  $f_{input} = 200$  MHz fed in the baseband generator ensures the  $Usable\_Bandwidth_{max}$ . After the DAC, this signal features a  $RF\_Bandwidth_{max} = 2 * b * f_{input} = 2 * b * 200$  MHz = 160 MHz.

### Impact of the oversampling factor

Waveforms generated by the R&S WinIQSIM2 software can be optimized by choosing a suitable integer oversampling factor.

Conventional ARB often assumes an oversampling factor of 4. The ARB of the R&S SMW200A requires low oversampling factors and still provides excellent signal quality in terms of EVM and ACP.

A reduced sample rate saves significantly the amount of memory or allows an increased signal cycle time, and vice versa.

#### 5.7.2.5 Marker signals and waveform length

The R&S SMW200A provides the possibility to define marker signals that are sent to the marker outputs in synchronicity with the I/Q output signals. Marker signals can be either predefined or later defined.

The I/Q data and marker data are located in separate memory areas of the SDRAM and can be independently configured. Each marker signal requires 1 bit of the available memory size. Sometimes, it is useful to generate a modulation signal without extra marker signals to increase the maximum waveform length.

The following example explains the dependency between the number of enabled marker signals, the available memory size, and the resulting waveform length.

#### Example: Calculating the maximum waveform length

The calculation assumes a R&S SMW200A with an ARB memory of 64 Msample, see [Section 5.7.1, "Required options"](#), on page 303.

- Total memory size = 256 Mbyte
- Required memory size (per complex sample) = 32 bit + 3 bit = 35 bit = 4.375 byte, where:
  - The raw I/Q samples are 16-bit values. For the length of I/Q data that is:  
 $2 \times 16 \text{ bit} = 32 \text{ bit}$  (16 bit per I/Q channel)
  - Each marker requires one bit. Three enabled markers require 3 bit.
- Maximum waveform length (with 3 markers) = 256 Mbyte / 4.375 byte = 58 Msample
- Theoretical maximum waveform length (no markers) = 256 Mbyte / 4 byte = 64 Msample

A memory size of 256 Mbyte yields a maximum waveform length of 58 Msample, if three markers are enabled. The maximum waveform length increases to 64 Msample, if the internal hardware markers are used, and the complete memory is available for I/Q data.

### 5.7.3 ARB settings

Access:

- ▶ Select "Baseband" > "ARB".

The "ARB" dialog enables direct selection of the waveform file to be processed, the selection of a test signal or access to the multi-segment and multicarrier settings.

If the current instrument configuration uses [Coupled sources](#), you can assign waveforms to all available basebands.

The dialog is divided into several tabs. In each case, the current setting is displayed in the tab name.

The remote commands required to define these settings are described in [Section 14.19.5.3, "SOURce:BB:ARbitrary subsystem"](#), on page 1092.

Settings:

- [ARB general settings](#)..... 309
- [Sine test signal settings](#)..... 314
- [Rectangular test signal settings](#)..... 315
- [Constant IQ test signal settings](#)..... 317
- [Trigger, marker and clock settings](#)..... 318

#### 5.7.3.1 ARB general settings

Access:

- ▶ Select "Baseband" > "ARB".

This tab provides general settings to select and create a waveform file and enable the ARB.

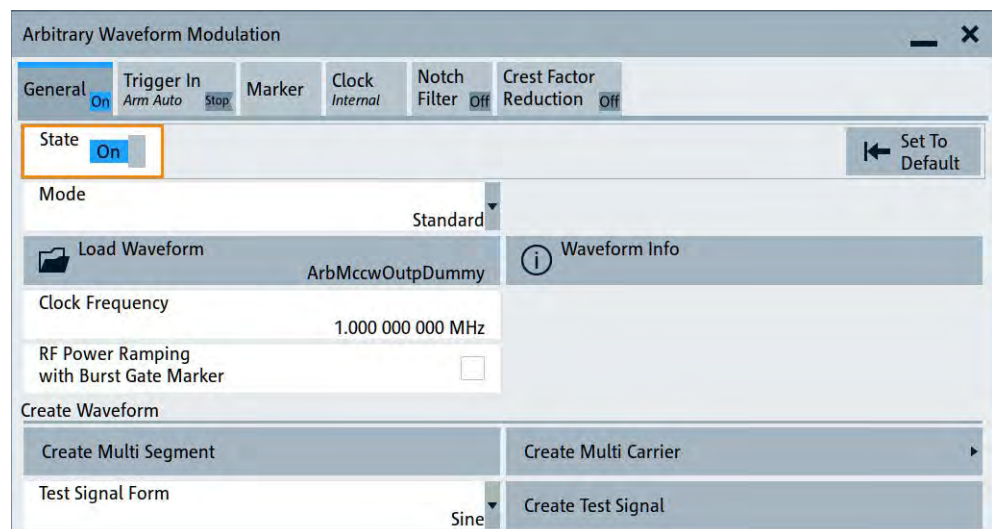

Further settings depend on the system configuration and the waveform type:

- If you use a single-segment waveform, the tab also provides settings for configuring the test signal and access to the settings for calculating a multi-segment or a multicarrier waveform.
- If you load a multi-segment waveform, the tab expands and displays the dedicated section "Multi Segment Waveform Options". This section provides settings to configure the segment to be output and adjust the trigger for the switch between the segments of the multi-segment waveform. The displayed parameters depend on the trigger source. The provided parameters are identical with the parameters in the section "Next Segment Trigger In" in the "Trigger" tab. See [Section 5.10.3.5, "Multi-segment waveform trigger settings"](#), on page 379.
- If the current instrument configuration uses [Coupled sources](#), the dialog displays a table with up to 8 rows, where the number of rows corresponds to the number of selected [Basebands \(Tx Antennas\)](#) or [Entities \(Users, Cells\)](#).

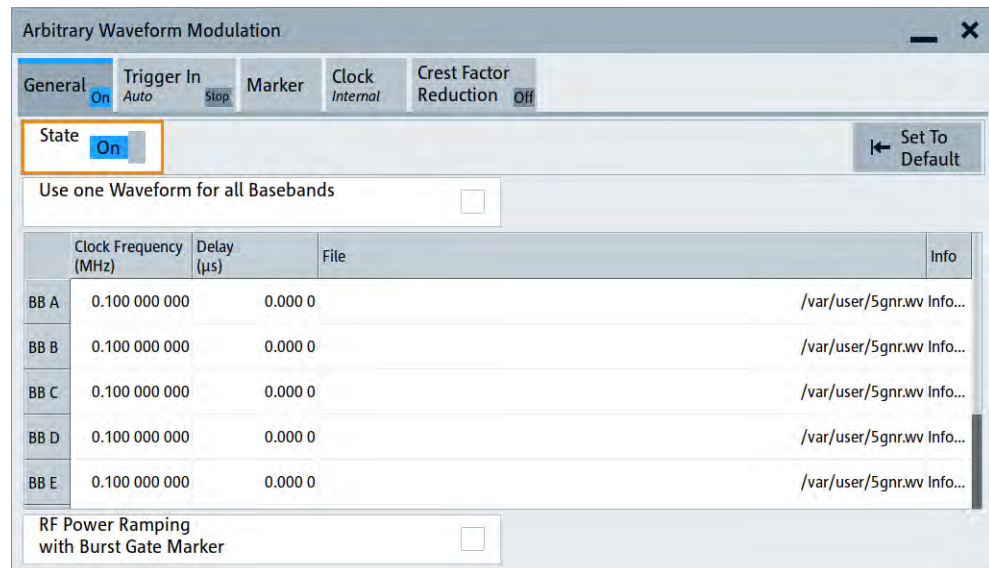

### Settings:

State.....	311
Set To Default.....	311
Use one Waveform for all basebands.....	311
Waveforms table.....	312
Load Waveform.....	312
Waveform Info.....	312
Clock Frequency.....	312
Delay.....	313
RF Power Ramping with Burst Marker.....	313
Create Multi Segment.....	313
Create Multi Carrier.....	313
Test Signal Form.....	313
Create Test Signal.....	313

**State**

Enables ARB modulation. Switching on the ARB turns off all the other digital standards and digital modulation types in the same signal path.

The output is based on the waveform file that is loaded. The name of the waveform file is displayed next to "Load Waveform". When a multi-segment waveform is loaded, the display expands and lists more settings, grouped in the "Multi Segment Waveform Options" section.

**Note:** ARB stays disabled.

You cannot enable the ARB in the following cases:

- **No or empty waveform file**  
By default, no waveform file is loaded. The "Load Waveform" button displays "None".  
Remedy: Select a waveform file, before activating the ARB.
- **Missing burst gate marker in the waveform**  
The "RF Power Ramping with Burst Gate Marker" state is "On" and the loaded ARB waveform does not contain a control list or the burst gate marker is not defined. An error message indicates the message above.  
Remedy: Define a burst gate marker in your waveform file.

Remote command:

[\[:SOURce<hw>\]:BB:ARbitrary:STATe](#) on page 1102

**Set To Default**

Calls default settings, see [Table 5-19](#).

*Table 5-19: ARB default settings*

Parameter	Value
State	Off
Clock Frequency	1 MHz
Trigger Mode	Auto
Trigger Source	Internal
Marker State	Off
Marker Mode	Unchanged
Clock Source	Internal

Remote command:

[\[:SOURce<hw>\]:BB:ARbitrary:PRESet](#) on page 1101

**Use one Waveform for all basebands**

If the current instrument configuration uses [Coupled sources](#), you can:

- Assign different waveforms to the available basebands ("BB A to H")
- Use the same waveform for all basebands ("BB All");  
the waveform selected for the first baseband ("BB A") is used.

To select the waveforms, use the parameter [File](#).

Remote command:

[\[:SOURce<hw>\]:BB:ARbitrary:COUPled:STATe](#) on page 1110

### Waveforms table

If the current instrument configuration uses [Coupled sources](#), the dialog displays a table with up to 8 rows, where the number of rows corresponds to the number of selected [Basebands \(Tx Antennas\)](#) or [Entities \(Users, Cells\)](#).

The waveforms table consists of one row only, if the parameter [Use one Waveform for all basebands](#) is enabled.

The following parameters are available per baseband:

- [Clock Frequency](#)
- [Delay](#)
- [File](#)
- [Waveform Info](#)

### Load Waveform

Opens the standard "File Select" function of the instrument. The provided navigation possibilities in the dialog are self-explanatory.

The waveform files have a predefined file extension `*.wv`. If you select a file, the dialog displays short information about the selected waveform.

Enable the ARB to trigger the instrument to load and process the selected waveform file.

Remote command:

`[ :SOURce<hw> ] :BB:ARbitrary:WAVeform:SElect` on page 1107

### Waveform Info

Opens a dialog with detailed information about the currently selected waveform. The display depends on whether the selected waveform file is a multisegment one or not. All parameters are read only.

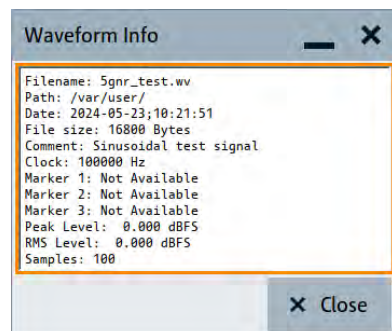

Remote command:

n.a.

For non-multi-segment waveform files, use the `Tag` commands. See [Section 5.7.5, "Tags for waveforms, data and control lists"](#), on page 335.

### Clock Frequency

Displays or sets the ARB output clock rate.

The value of this parameter is set to the clock rate defined in the loaded waveform file (`{CLOCK}` tag). The value can be changed afterwards.

**Note:** The clock frequency must match the value of the externally applied clock source.



Remote command:

`[ :SOURce<hw> ] :BB:ARBitrary:CLOCK` on page 1110

### Delay

When [Coupled sources](#) are used, all basebands are triggered with a common trigger signal.

Enable a time delay to delay the waveform processing of a particular baseband.

Remote command:

`[ :SOURce<hw> ] :BB:ARBitrary:COUPlEd:TRIGGer:DELay:OFFSet`  
on page 1110

### RF Power Ramping with Burst Marker

Option: R&S SMW-K22

If activated, the burst gate marker signal included in the ARB waveform file is used as the marker signal for the pulse modulator.

If this parameter is activated, but the loaded ARB waveform does not contain a control list or the burst gate marker is not defined, the ARB cannot be activated. An error message indicates this situation, too.

You can create the suitable waveform files including the required burst gate marker signals, for example, with the R&S Pulse Sequencer software.

Remote command:

`[ :SOURce<hw> ] :BB:ARBitrary:PRAMp [ :STATe ]` on page 1102

### Create Multi Segment

Opens the dialog for creating multi-segment waveforms, see [Section 5.10, "Generating multi-segment waveform files"](#), on page 360.

### Create Multi Carrier

Opens the dialog for creating multicarrier waveforms, see [Section 5.11, "Generating multicarrier waveform signals"](#), on page 391.

### Test Signal Form

Selects the form of the test signal. A choice between a sinusoidal, rectangular, AWGN or test signal with constant I/Q is provided.

To access further settings, select [Create Test Signal](#).

"AWGN" Requires R&S SMW-K811, see [Section 5.8.4, "AWGN test signal settings"](#), on page 358.

Remote command:

`[ :SOURce<hw> ] :BB:ARBitrary:SIGNal:TYPE` on page 1103

### Create Test Signal

Opens a dialog with further test signal settings. Provided are the following test signals:

- [Section 5.7.3.2, "Sine test signal settings"](#), on page 314
- [Section 5.7.3.3, "Rectangular test signal settings"](#), on page 315
- [Section 5.7.3.4, "Constant IQ test signal settings"](#), on page 317
- [Section 5.8.4, "AWGN test signal settings"](#), on page 358

### 5.7.3.2 Sine test signal settings

Access:

1. Select "Baseband" > "ARB" > "General".
2. Select "Test Signal Form" > "Sine".
3. Select "Create Test Signal".

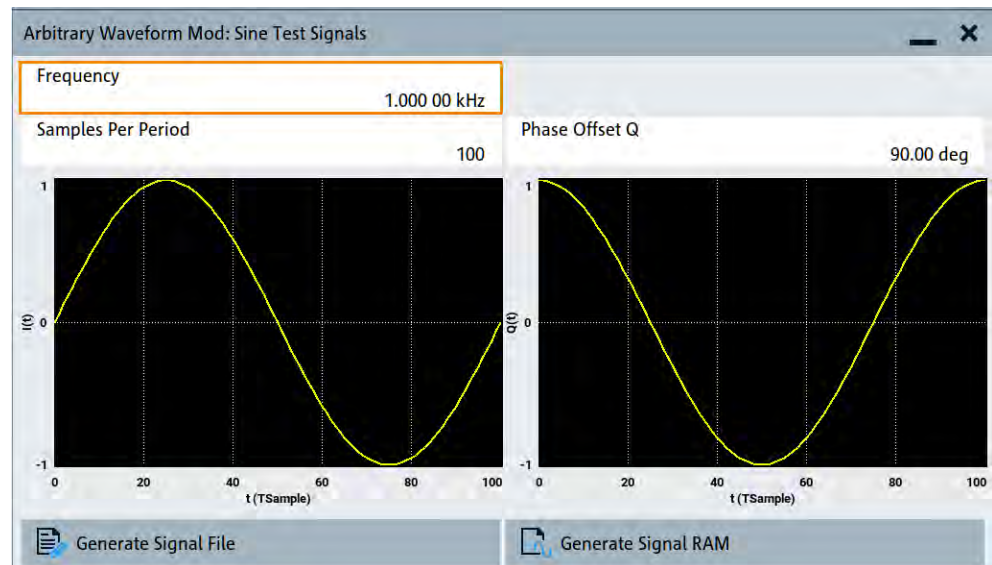

This dialog provides settings to configure a sinusoidal test signal. A sine wave is generated on the I path, and a sine wave of the same frequency but phase-shifted is generated on the Q path. For more information, refer to [Section 5.7.2.3, "ARB test signals"](#), on page 305.

The dialog displays the characteristic of the currently selected signal.

#### Settings:

Frequency.....	314
Samples per Period.....	314
Phase Offset Q.....	315
Generate Signal File.....	315
Generate Signal RAM.....	315

#### Frequency

Enters the frequency of the test signal.

Remote command:

`[ :SOURce<hw> ] :BB:ARbitrary:TSIGnal:SINE:FREQuency` on page 1104

#### Samples per Period

Enters the number of sample values required from the sine wave per period.

The maximum allowed value is determined by the maximum ARB clock rate and the selected frequency.

For more information, refer to the specifications document.

Remote command:

`[ :SOURce<hw> ] :BB:ARbitrary:TSIGnal:SINE:SAMPles` on page 1105

#### Phase Offset Q

Enters the phase offset of the sine-wave signal on the Q channel relative to the sine-wave signal on the I channel.

Remote command:

`[ :SOURce<hw> ] :BB:ARbitrary:TSIGnal:SINE:PHASe` on page 1105

#### Generate Signal File

Generates a signal and saves it as a waveform file on the hard disk. Use the standard "File Select" function to save the file.

Remote command:

`[ :SOURce<hw> ] :BB:ARbitrary:TSIGnal:SINE:CREate:NAMed` on page 1105

#### Generate Signal RAM

Generates a signal and uses this signal as output straight away. The instrument saves the file using a predefined filename.

Remote command:

`[ :SOURce<hw> ] :BB:ARbitrary:TSIGnal:SINE:CREate` on page 1106

### 5.7.3.3 Rectangular test signal settings

Access:

1. Select "Baseband" > "ARB" > "General".
2. Select "Test Signal Form" > "Rect".
3. Select "Create Test Signal".

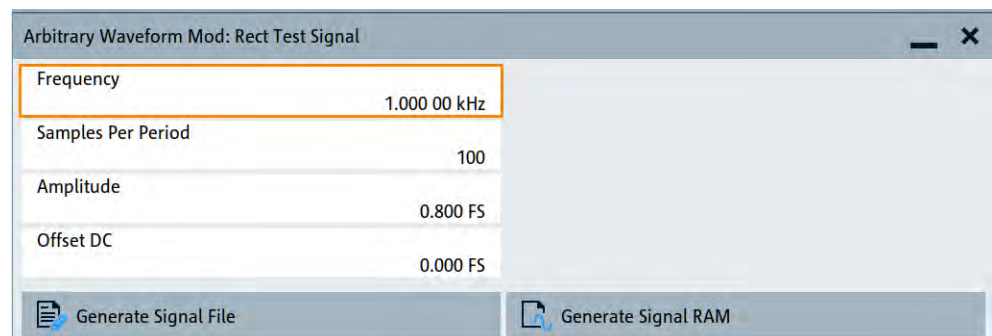

This dialog provides settings to configure a rectangular test signal. A rectangular test signal with a duty factor of 0.5 is created. Amplitude and offset are adjustable. Both paths, I and Q, use the same signal.

For more information, refer to [Section 5.7.2.3, "ARB test signals"](#), on page 305.

**Settings:**

Frequency.....	316
Samples per Period.....	316
Amplitude.....	316
Offset DC.....	316
Generate Signal File.....	316
Generate Signal RAM.....	316

**Frequency**

Enters the frequency of the test signal.

Remote command:

`[ :SOURce<hw> ] :BB:ARbitrary:TSIGnal:RECTangle:FREQuency` on page 1103

**Samples per Period**

Enters the number of sample values required for the rectangular signal per period.

The maximum allowed value is determined by the maximum ARB clock rate and the selected frequency.

For more information, refer to the specifications document.

Remote command:

`[ :SOURce<hw> ] :BB:ARbitrary:TSIGnal:RECTangle:SAMPles` on page 1104

**Amplitude**

Enters the digital amplitude of the rectangular wave. The abbreviation FS means full-scale.

Remote command:

`[ :SOURce<hw> ] :BB:ARbitrary:TSIGnal:RECTangle:AMPLitude` on page 1103

**Offset DC**

Enters a DC component.

Remote command:

`[ :SOURce<hw> ] :BB:ARbitrary:TSIGnal:RECTangle:OFFSet` on page 1104

**Generate Signal File**

Generates a signal and saves it as a waveform file on the hard disk. Use the standard "File Select" function to save the file.

Remote command:

`[ :SOURce<hw> ] :BB:ARbitrary:TSIGnal:RECTangle:CREate:NAMed`  
on page 1105

**Generate Signal RAM**

Generates a signal and outputs it straight away. The instrument saves the file using a predefined filename.

Remote command:

`[ :SOURce<hw> ] :BB:ARbitrary:TSIGnal:SINE:CREate` on page 1106

### 5.7.3.4 Constant IQ test signal settings

Access:

1. Select "Baseband" > "ARB" > "General".
2. Select "Test Signal Form" > "Const IQ".
3. Select "Create Test Signal".

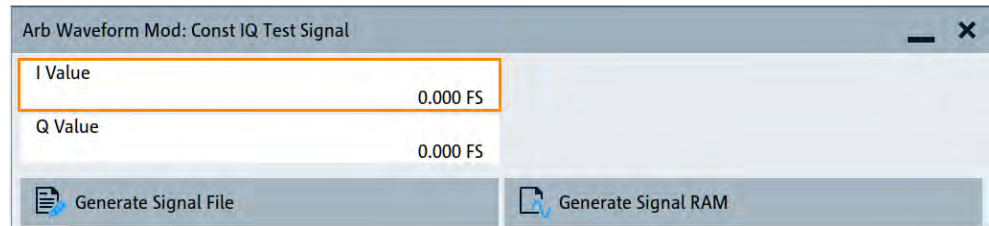

This dialog provides settings to configure a continuous test signal with constant IQ. The I and Q values for each path are adjustable but constant. For more information, refer to [Section 5.7.2.3, "ARB test signals"](#), on page 305.

If converted to an analog signal, the signal is output directly at the I and Q connectors of the instrument.

#### Settings:

<a href="#">I Value/Q Value</a> .....	317
<a href="#">Generate Signal File</a> .....	317
<a href="#">Generate Signal RAM</a> .....	317

#### I Value/Q Value

Sets the value for the I component and Q component of the test signal.

Remote command:

`[ :SOURce<hw> ] :BB:ARBitrary:TSIGnal:CIQ:I` on page 1103

`[ :SOURce<hw> ] :BB:ARBitrary:TSIGnal:CIQ:Q` on page 1103

#### Generate Signal File

Generates a signal and saves it as a waveform file on the hard disk. Use the standard "File Select" function to save the file.

Remote command:

`[ :SOURce<hw> ] :BB:ARBitrary:TSIGnal:CIQ:CREate:NAMed` on page 1105

#### Generate Signal RAM

Generates a signal and uses this signal as output straight away. The instrument saves the file using a predefined filename.

Remote command:

`[ :SOURce<hw> ] :BB:ARBitrary:TSIGnal:CIQ:CREate` on page 1106

### 5.7.3.5 Trigger, marker and clock settings

These tabs provide standard settings.

For a detailed description, see the following sections:

- [Section 5.5.2.1, "Trigger settings"](#), on page 252
- [Section 5.5.2.2, "Marker settings"](#), on page 258
- [Section 5.5.2.3, "Clock settings"](#), on page 259
- [Section 5.5.2.4, "Local and global connectors settings"](#), on page 261

The following settings are specific to the ARB dialog.

<a href="#">Processing Time</a> .....	318
<a href="#">Mode</a> .....	318
<a href="#">Delay (Time)</a> .....	319

#### Processing Time

Displays the internal processing time.

The processing time is the elapsed time between the input of the external trigger event and the output of the baseband signal. An additional delay applies to the RF signal with respect to the baseband signal depending on the RF frequency.

For more information, see ["Starting the signal generation with the first sample"](#) on page 240.

Remote command:

`[ :SOURce<hw> ] :BB:ARBitrary:TRIGger:PTIME?` on page 1142

#### Mode

Sets the marker mode that defines the shape and periodicity of the marker signal.

You can configure individual marker modes for each marker signal. The number of available markers is 3. The marker configuration changes with the selected marker mode.

For more information on marker modes, see [Section 5.5.1.4, "About marker signals"](#), on page 231.

**Note:** Setting an ARB marker mode that is different than "Unchanged" does not change the marker trace in the loaded waveform file. But, when playing the waveform file the instrument uses the configured ARB marker mode.

The instrument routes the generated marker signals to the selected output connectors.

See also [Section 12.2, "Configuring local and global connectors"](#), on page 742.

"Unchanged" The waveform file with its configured marker traces defines the marker signal of the ARB baseband signal.

Remote command:

`[ :SOURce<hw> ] :BB:ARBitrary:TRIGger:OUTPut<ch>:MODE` on page 1146

`[ :SOURce<hw> ] :BB:ARBitrary:TRIGger:OUTPut<ch>:PULSe:DIVider`  
on page 1147

`[ :SOURce<hw> ] :BB:ARBitrary:TRIGger:OUTPut<ch>:PULSe:FREQuency?`  
on page 1147

`[ :SOURce<hw> ] :BB:ARBitrary:TRIGger:OUTPut<ch>:PATtern` on page 1146

[\[:SOURce<hw>\]:BB:ARbitrary:TRIGger:OUTPut<ch>:OFFTime](#) on page 1146

[\[:SOURce<hw>\]:BB:ARbitrary:TRIGger:OUTPut<ch>:ONTime](#) on page 1146

### Delay (Time)

Shows the marker delay time in microseconds, milliseconds or seconds depending on the marker delay.

Remote command:

[\[:SOURce<hw>\]:BB:ARbitrary:TRIGger:OUTPut<ch>:DINSec?](#) on page 1148

## 5.7.4 Playing waveform files

This section provides step-by-step instructions to create, generate and play waveform files on the R&S SMW200A. Provided the R&S SMW200A is equipped with the required option, you can load this waveform file and process it with the instrument.

For details on individual functions and settings, see [Section 5.7.3, "ARB settings"](#), on page 309.

Some test cases do not require a real-time signal generation according to a digital standard. For these test cases, the replay of a previously generated waveform is sufficient. Generate these waveform files as follows:

- Internal waveform generation with the following functions:
  - "Generate Waveform File" function, see [Section 5.7.4.2, "Using the function Generate Waveform"](#), on page 320.
  - "Create Test Signal" function, see [Section 5.7.4.1, "Generating ARB test signals"](#), on page 320.
- External waveform generation with Rohde & Schwarz software products:
  - For R&S WinIQSIM2, see [Section 5.7.4.4, "Working with R&S WinIQSIM2"](#), on page 321
  - For R&S ARB Toolbox, see [1GP88](#).
  - For R&S SMW-K300/-K301 Pulse Sequencer, see the R&S Pulse Sequencer software user manual.
- External waveform generation with MATLAB, see [Section 5.7.4.5, "Creating waveforms with tag file format"](#), on page 326 and [1GP60](#).

This section provides examples on the internal waveform file generation and on the external generation with R&S WinIQSIM2.

• <a href="#">Generating ARB test signals</a> .....	320
• <a href="#">Using the function Generate Waveform</a> .....	320
• <a href="#">Loading and playing waveform files</a> .....	321
• <a href="#">Working with R&amp;S WinIQSIM2</a> .....	321
• <a href="#">Creating waveforms with tag file format</a> .....	326
• <a href="#">Defining periodically repeating traces</a> .....	331
• <a href="#">Creating control lists with tag file format</a> .....	332
• <a href="#">Creating data lists with tag file format</a> .....	334
• <a href="#">Editing waveform files, data and control lists</a> .....	335

### 5.7.4.1 Generating ARB test signals

If your test case requires a simple sine signal or square signal, use the ARB test signals.

#### To generate a sine test signal

1. Select "Baseband" > "ARB"
2. Select "Create Test Signal" > "Sine".
3. Adjust the "Sine Test Signal" settings as required.
4. Select "Generate Signal File".  
A standard file select dialog opens.
  - a) Navigate to the directory in that you want to save the file, for example `/var/user/`.
  - b) Enter a filename, for example `sine_waveform`.
  - c) Click "Save".The R&S SMW200A saves the generated waveform file and automatically loads it in the ARB.
5. Select "ARB" > "State" > "On".  
The R&S SMW200A processes the waveform file.

To create an AWGN test signal, see [Section 5.8.4, "AWGN test signal settings"](#), on page 358.

### 5.7.4.2 Using the function Generate Waveform

The general settings dialog of several digital standards provides the built-in function "Generate Waveform".

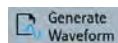

This function enables the calculation of the signal and saves the information in a waveform file. After saving, you can load the waveform file in the ARB.

#### To generate an LTE waveform file

1. Select "Baseband" > "EUTRA/LTE/IoT".
2. Adjust the settings as required, for example:
  - a) Select "Link Direction" > "Downlink".
  - b) Select a predefined test model, for example, "Test Models" > "E-TM1\_1\_\_10MHz".
3. Select "State" > "On".
4. Select "Generate Waveform".  
A standard file select dialog opens.



- a) Navigate to the directory in that you want to save the file, for example `/var/user/`.
- b) Enter a filename, for example `lte_waveform`).
- c) Click "Save".

The R&S SMW200A saves the generated waveform file `lte_waveform.wv` in the selected directory `/var/user/`.

To process the waveform file, load it in the ARB, see [Section 5.7.4.3, "Loading and playing waveform files"](#), on page 321.

### 5.7.4.3 Loading and playing waveform files

Irrespectively on how you generate a waveform, you can transfer it to the instrument, load it in the ARB and play it.

#### To load and play a waveform file

1. Transfer an externally created waveform file to the instrument.  
See [Section 11.9, "Transferring files from and to the instrument"](#), on page 725.
2. Select "Baseband" > "ARB".
3. Select "Load Waveform".  
A standard file select dialog opens.
  - a) Navigate to the directory that the waveform file contains.
  - b) Select the waveform file, for example `/var/user/lte_waveform`.
  - c) Click "Select".The "ARB" dialog confirms that the waveform file is loaded.
4. Select "ARB" > "State" > "On".

The R&S SMW200A processes the waveform file.

### 5.7.4.4 Working with R&S WinIQSIM2

The following example illustrates how to use R&S WinIQSIM2 simulation software to generate an EUTRA/LTE waveform and load it in the ARB of the R&S SMW200A.

The workflow consists of three main steps, each described in a separate step-by-step instruction:

- Configuring the connection between the R&S WinIQSIM2 and the R&S SMW200A
- Generating of a waveform file with the required settings
- Transferring the waveform file to and playing it with the R&S SMW200A.



This section does not describe the R&S WinIQSIM2 simulation software but focuses on the task-related settings. For a description of the simulation software, see the R&S WinIQSIM2 user manual.

### To define the R&S SMW200A as destination instrument

In this example, we assume that the R&S WinIQSIM2 is installed on a remote controller. This remote controller is connected over LAN to the R&S SMW200A.

The general instrument settings of the destination instrument affect various functions, for example, the maximum size of the file the waveform is saved in. We recommend that you configure the destination instrument before you generate the waveform with the R&S WinIQSIM2.

1. In the R&S WinIQSIM2, select "File" > "New" to preset the software.
2. In the block diagram, select "Vector Sig Gen" > "Instruments".

The "Configure Instruments" dialog opens. The list of configured instruments is empty.

3. Select "Configure Instruments" > "Scan".

The software scans the network for connected and active instruments.

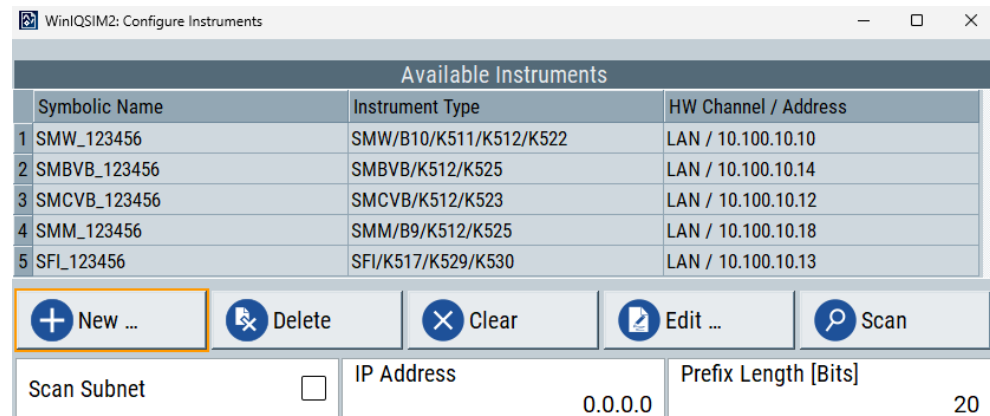

Alternatively, use the "New" function to add the R&S SMW200A manually to the list of instruments.

4. Close the dialog.
5. In the block diagram, select "Vector Sig Gen" block and select the R&S SMW200A form the list.

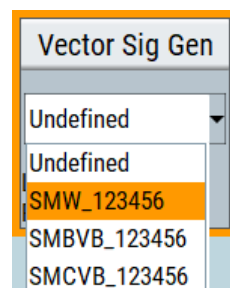

6. In the block diagram, select "ARB Sig Gen" block and select the R&S SMW200A form the list.

The two lines to the "Vector Sig Gen" and "ARB Sig Gen" blocks on the block diagram confirm that a remote connection to the R&S SMW200A is established.

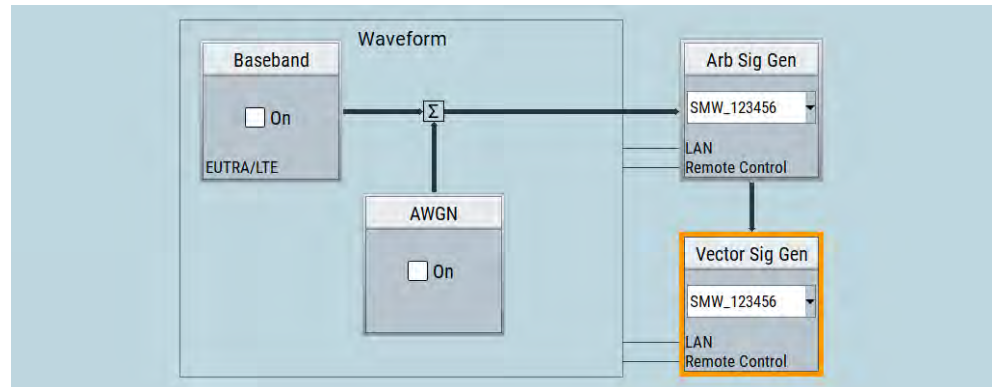

### To generate a waveform file with R&S WinIQSIM2

1. In the block diagram of R&S WinIQSIM2, select "Baseband" > "EUTRA/LTE/IoT".
2. Adjust the settings as required, for example:
  - a) Select "Link Direction" > "Downlink (OFDMA)"
  - b) Select a predefined test model, for example, "Test Models" > "E-TM1\_1\_\_10MHz".
3. Select "EUTRA/LTE/IoT" > "State" > "On".

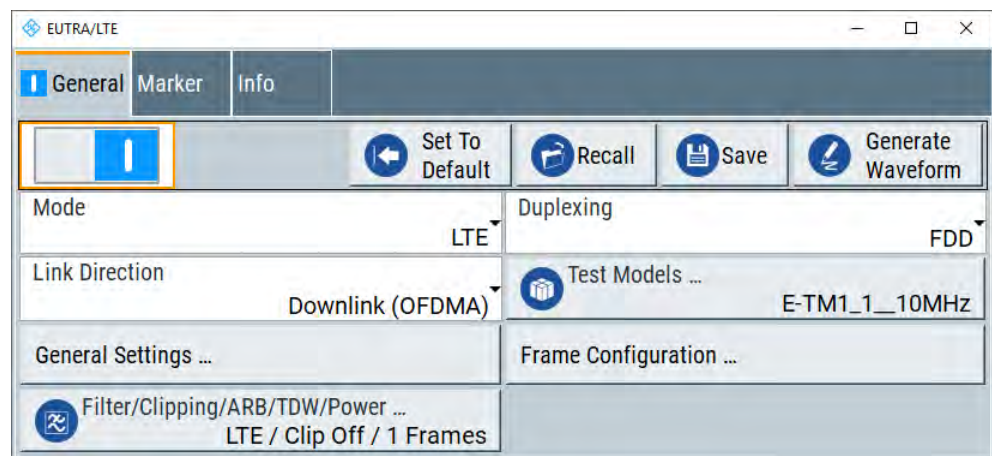

R&S WinIQSIM2 calculates the signal and displays important signal parameters, for example, number of samples "Samples" and "Sample Rate".

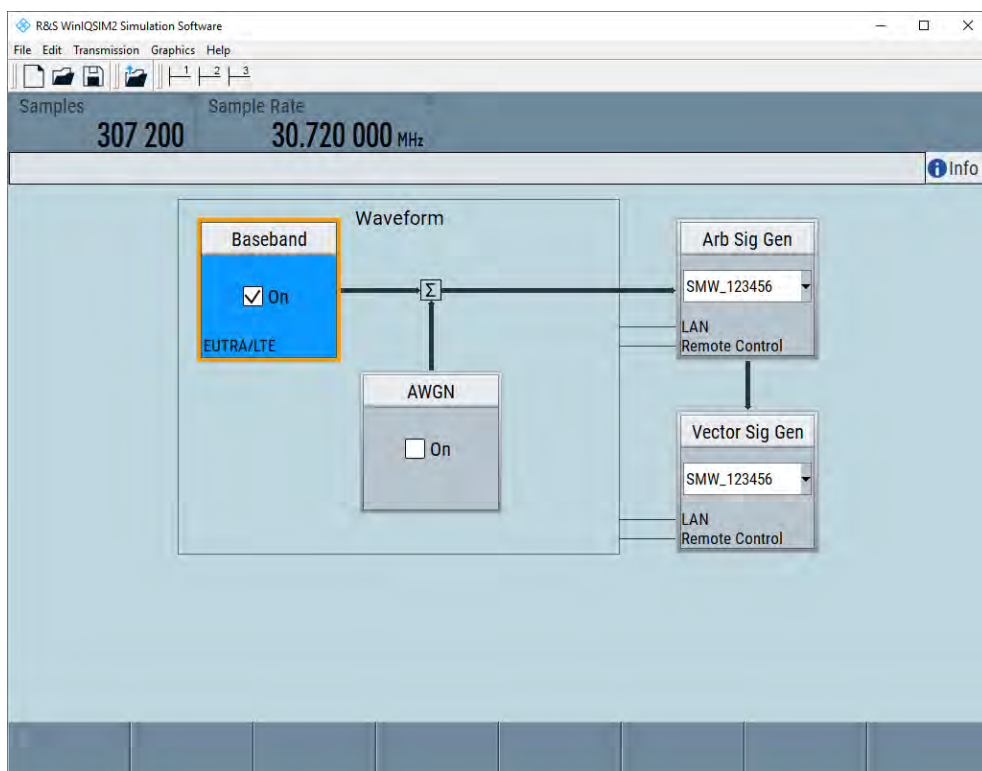



Select "Graphics" > "Graphic 1 (Complete)" to check for more information on the generated signal.

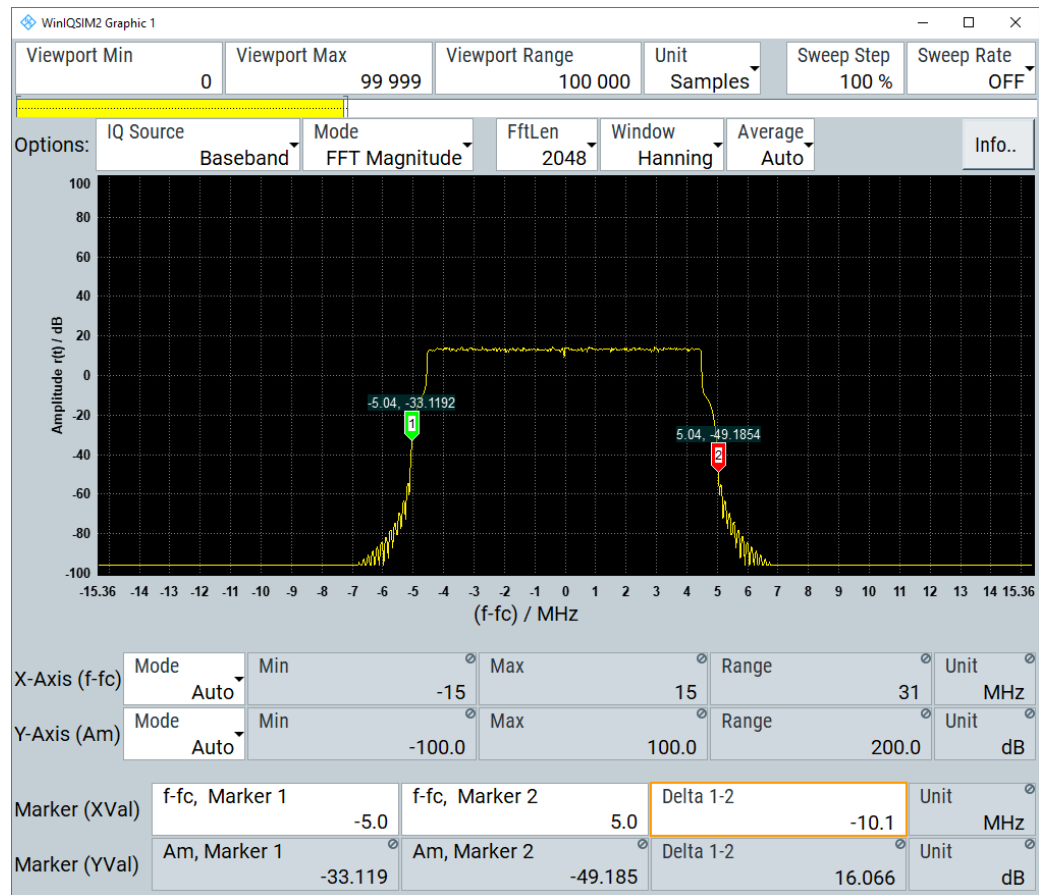

The display confirms the expected EUTRA/LTE 10 MHz spectrum.

### To transfer the waveform file to the R&S SMW200A

1. At R&S WinIQSIM2, select "Transmission" > "Transmit".
2. In the "Waveform Transmission to Arbitrary Waveform Generator" dialog, proceed as follows:
  - a) "Transmit from" > "Internal (WinIQSIM2)".
  - b) "Transmit to" > "Instrument".
  - c) Select "File".
  - d) Define the filename of the transmitted file.
  - e) Activate "Automatically Load and Start Waveform".
  - f) Select the required baseband, for example "Path A".
  - g) Add a comment to the waveform, for example as follows:  
"User Comment for File/Waveform" > "LTE\_TM\_1-10\_WinIQSIM2\_WV"
  - h) Select "Transmit".

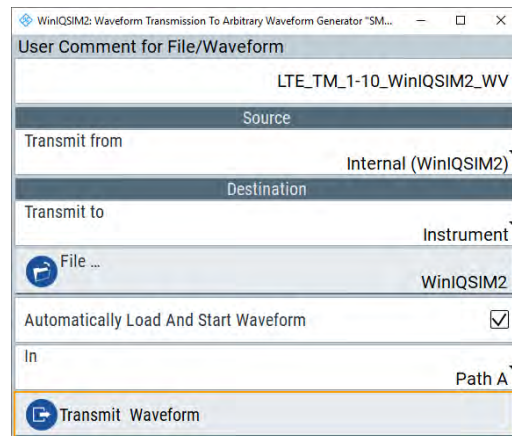

R&S WinIQSIM2 transmits the waveform to the default directory of the R&S SMW200A.

3. In the R&S SMW200A, select "Baseband" > "ARB".

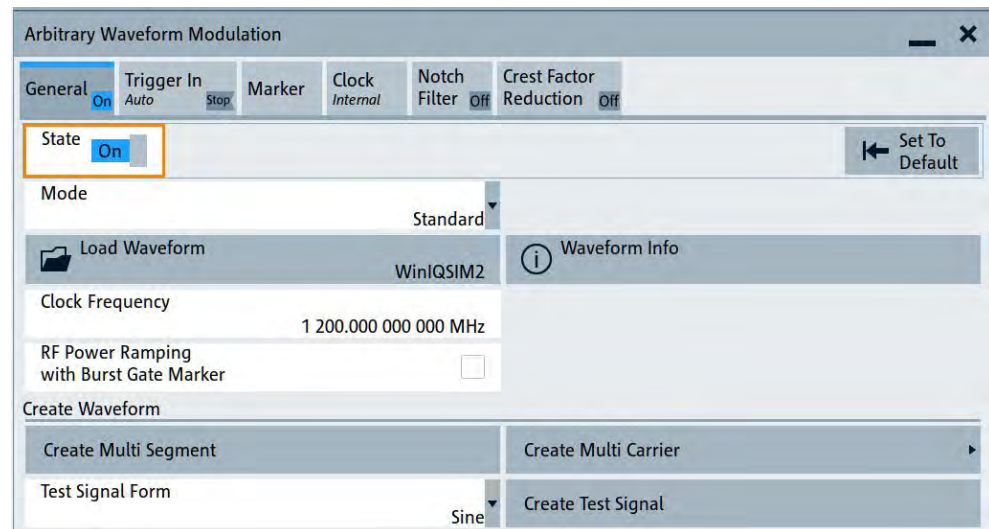

The dialog confirms that the ARB is active and plays the transmitted waveform.

#### 5.7.4.5 Creating waveforms with tag file format

As described in [Section 5.7.2.2, "About waveform files"](#), on page 304, you can generate waveform files internally, with the built-in function, and externally. For description on how to generate waveform files internally, see [Section 5.7.4.2, "Using the function Generate Waveform"](#), on page 320. This section provides an example of how to create a waveform externally. The waveform file is created manually; the tag-oriented file format is used.

The provided example uses a sine function in the I channel and a cosine function in the Q channel, each with 20 points. The example uses a short program written in the programming language C to calculate the sine and cosine values (see [Example "C-program for creating a waveform file"](#) on page 329). They are saved in the file `SICO.txt`.

The decimal values in `SICO.txt` are normalized such that they are between  $-1.0$  and  $+1.0$ . The data is converted into binary format. The appropriate mandatory tags are added and the data is packed into the `WAVEFORM` tag. As result, the waveform file `SICO.wv` is generated.

This example follows the general principle of creating of a waveform manually, using the tag file format. The [Figure 5-19](#) illustrates this general workflow.

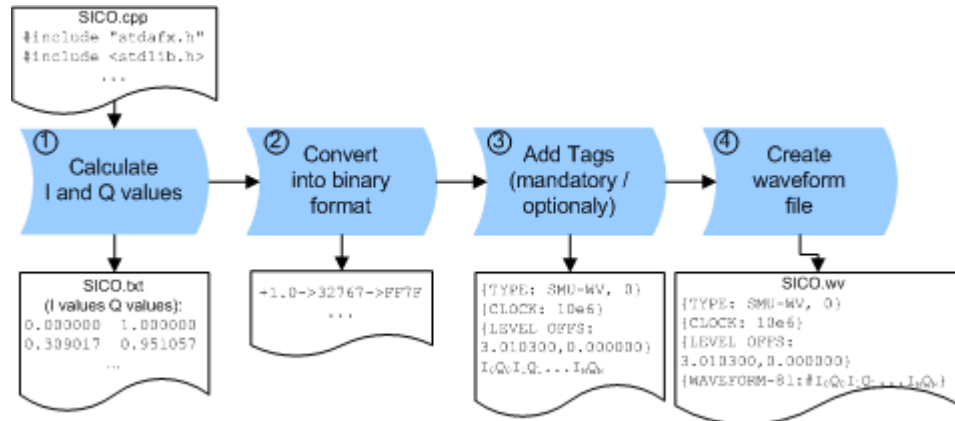

**Figure 5-19: Principle of creating a waveform manually**

The following steps outline how to create the waveform file `SICO.wv`:

1. Calculate the sine and cosine values. For example, use the `SICO.cpp` program.

The result is saved in the file `SICO.txt`.

```

0.000000 1.000000
0.309017 0.951057
0.587785 0.809017
0.809017 0.587785
0.951057 0.309017
1.000000 -0.000000
0.951057 -0.309017
0.809017 -0.587785
0.587785 -0.809017
0.309017 -0.951057
-0.000000 -1.000000
-0.309017 -0.951056
-0.587785 -0.809017
-0.809017 -0.587785
-0.951056 -0.309017
-1.000000 0.000000
-0.951056 0.309017
-0.809017 0.587785
-0.587785 0.809017
-0.309017 0.951057

```

**Figure 5-20: Contents of `SICO.txt`: first column Sine (I), second column Cosine (Q)**

## Using the arbitrary waveform generator (ARB)

- Convert the values from the file `SICO.txt` into binary format consisting of 16-bit signed integer numbers. The numeric range between  $-1.0$  and  $+1.0$  corresponds to the modulation range of the waveform 16-bit D/A converter of  $-32767$  to  $+32767$ .

$+1.0 \rightarrow 32767 \rightarrow = 0x7FFF$

$0.0 \rightarrow 0 \rightarrow = 0x0000$

$-1.0 \rightarrow -32767 \rightarrow = 0x8001$

The [Figure 5-21](#) shows the calculation and conversion steps. The highlighted columns contain the resulting I and Q values represented in Little endian format.

Sample n	deg $= 360^\circ/20 * n$	$I = \sin(\text{deg})$	$I_{\text{quant,dec}} = I * FS = I * (2^{15}-1)$	$I_{\text{quant,hex}}$	$I_{\text{quant,hex}}$ (little-endian waveform file representation)	$Q = \cos(\text{deg})$	$Q_{\text{quant,dec}} = Q * FS = Q * (2^{15}-1)$	$Q_{\text{quant,hex}}$	$Q_{\text{quant,hex}}$ (little-endian waveform file representation)
0	0	0.000000	0	0000	0000 $I_0$	1.000000	32767	7FFF	FF7F $Q_0$
1	18	0.309017	10126	278E	8E27	0.951057	31163	79BB	BB79
2	36	0.587785	19260	4B3C	3C4B	0.809017	26509	678D	8D67
3	54	0.809017	26509	678D	8D67	0.587785	19260	4B3C	3C4B
4	72	0.951057	31163	79BB	BB79	0.309017	10126	278E	8E27
5	90	1.000000	32767	7FFF	FF7F	0.000000	0	0000	0000
6	108	0.951057	31163	79BB	BB79	-0.309017	-10126	D872	72D8
7	126	0.809017	26509	678D	8D67	-0.587785	-19260	B4C4	C4B4
8	144	0.587785	19260	4B3C	3C4B	-0.809017	-26509	9873	7398
9	162	0.309017	10126	278E	8E27	-0.951057	-31163	8645	4586
10	180	0.000000	0	0000	0000	-1.000000	-32767	8001	0180
11	198	-0.309017	-10126	D872	72D8	-0.951057	-31163	8645	4586
12	216	-0.587785	-19260	B4C4	C4B4	-0.809017	-26509	9873	7398
13	234	-0.809017	-26509	9873	7398	-0.587785	-19260	B4C4	C4B4
14	252	-0.951057	-31163	8645	4586	-0.309017	-10126	D872	72D8
15	270	-1.000000	-32767	8001	0180	0.000000	0	0000	0000
16	288	-0.951057	-31163	8645	4586	0.309017	10126	278E	8E27
17	306	-0.809017	-26509	9873	7398	0.587785	19260	4B3C	3C4B
18	324	-0.587785	-19260	B4C4	C4B4	0.809017	26509	678D	8D67
19	342	-0.309017	-10126	D872	72D8	0.951057	31163	79BB	BB79

Figure 5-21: I and Q values calculation and conversion

- Use an ASCII editor which is able to handle binary data. Create and add the following mandatory tags before this binary data set can be further processed:
  - TYPE
  - CLOCK
  - LEVEL OFFS

An example of the `SICO.wv` file contents could be:

```
{TYPE: SMU-WV, 0}{CLOCK: 10e6}{LEVEL OFFS: 3.010300,0.000000}
0000FF7F8E27BB79 ... 72D8BB79
```

To simplify the example, the checksum is set to 0, i.e. the instrument does not evaluate a checksum.

**Tip:** The tags `TYPE`, `CLOCK`, `LEVEL OFFS` and `WAVEFORM` are mandatory for each waveform. All other tags are optional and can be inserted after the `TYPE` tag in arbitrary order.

- Pack the binary data into a `WAVEFORM` tag with the described structure.

```
{WAVEFORM-Length: #I0Q0I1Q1I2Q2 ... InQn}
```

- Calculate the `Length`



Length = Number of I/Q pairs \* 4 + 1 = 20\*4 + 1 = 81 bytes

- Place the string {WAVEFORM-81:# at the beginning of the data set
- Place the symbol } at the end of the data set

The contents of the waveform file SICO.wv for 20 I/Q pairs is now ready for operation and reads:

```
{TYPE: SMU-WV,0}
{CLOCK: 10e6}
{LEVEL OFFS: 3.010300,0.000000}
{WAVEFORM-81:#I0Q0I1Q1...InQn}
```

There is no readable representation for binary values in this document. This example uses the sequence I0Q0I1Q1...InQn to characterize the binary code. The following figure shows this waveform in a data editor.

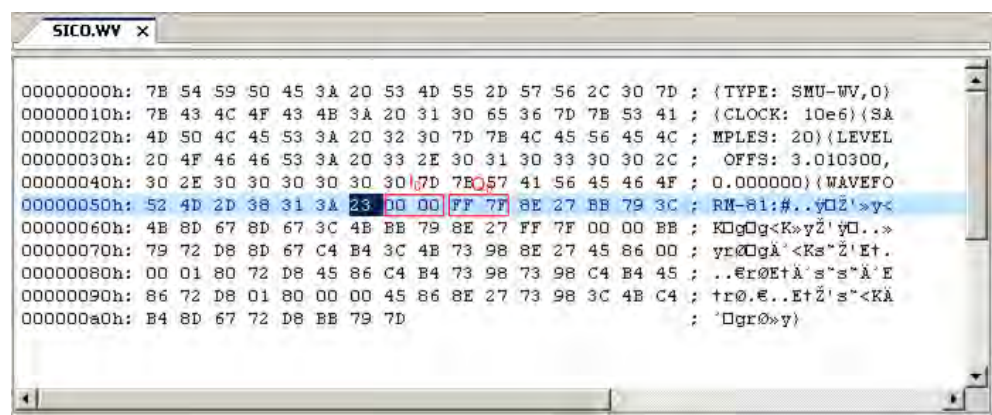

### Example: C-program for creating a waveform file

C-program SICO.cpp for creating the file SICO.txt containing 20 sine and cosine pairs, converting them into binary data and creating the waveform file SICO.wv.

```
// SICO.cpp
// Defines the entry point for the console application

#include "stdafx.h"
#include <stdlib.h>
#include <stdio.h>
#include <math.h>

int _tmain(int argc, _TCHAR* argv[])
{
    const unsigned int samples = 20;
    const float pi = 3.141592654f;
    int i;

    // SICO.txt
    // Creating the file SICO.txt containing 20 sine and cosine pairs
    float grad, rad;
    FILE *fp;
    fp = fopen("SICO.txt", "w");
```

```

if (fp == 0)
    return;
for (i=0; i<samples; i++)
{
    grad = (360.0f / (float)samples) * (float)i;
    rad = grad * (pi / 180.0f);
    fprintf(fp, "%f %f\n", sin(rad), cos(rad));
}
fclose(fp);

// SICO.wv
// Generating a binary data set from the I/Q pairs in the file SICO.txt
// and storing the result to file SICO.wv
FILE *fp_sour, *fp_dest;
float i_float, q_float;
unsigned short i_usint, q_usint;
fp_sour = fopen("SICO.TXT", "rt");
if (fp_sour == 0)
    return -1;
fp_dest = fopen("SICO.WV", "wb");
if (fp_dest == 0)
{
    fclose(fp_sour);
    return -1;
}
// Write required tags to waveform file
fprintf(fp_dest, "{TYPE: SMU-WV,0}");
fprintf(fp_dest, "{CLOCK: 10e6}");
fprintf(fp_dest, "{SAMPLES: %d}", samples);
// RMS, Peak
fprintf(fp_dest, "{LEVEL OFFS: %f,%f}", -1.0f * 20.0f * log10(1.0f/sqrt(2.0f)), 0.0f);
fprintf(fp_dest, "{WAVEFORM-%d:#", (samples * 4) + 1);
for (i=0; i<samples; i++)
{
    // Read I/Q pair from ASCII file
    if (fscanf(fp_sour, "%f %f", &i_float, &q_float) == EOF)
        break;
    // Convert I/Q pair to unsigned short
    i_usint = (unsigned short)floor((i_float * 32767.0) + 0.5);
    q_usint = (unsigned short)floor((q_float * 32767.0) + 0.5);
    // Write converted I/Q pair to waveform file
    fwrite(&i_usint, 2, 1, fp_dest);
    fwrite(&q_usint, 2, 1, fp_dest);
}
fprintf(fp_dest, "});
fclose(fp_dest);
fclose(fp_sour);
return 0;
}

```

### 5.7.4.6 Defining periodically repeating traces

If your test setup requires marking an event, for example, each frame start, it is sufficient to define the trace once and repeat it over the length of a waveform. Repeating is useful for long waveforms with periodical marker signals.

The following examples use marker traces. You can use control lists analogously.

#### To define periodical marker trace

The waveform in the example below consists of three frames, each frame has a length of 100 samples. Waveform processing is continuous via "Trigger Mode" > "Auto".

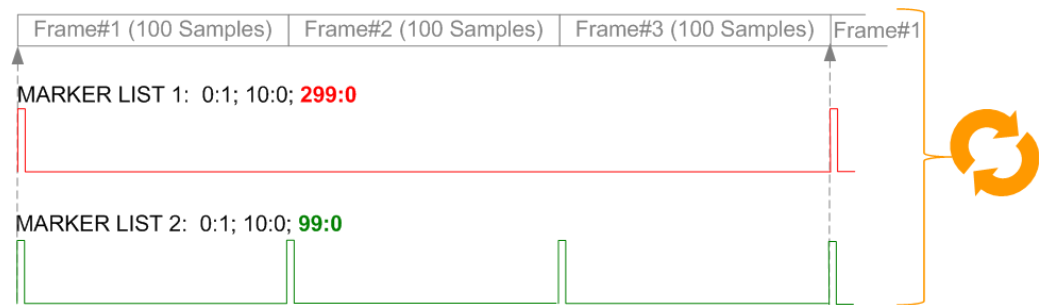

Figure 5-22: Example: Defining marker traces without **CONTROL LENGTH** tag

To define a restart marker and a frame start marker, use the following tags:

1. The waveform is 300 samples long, i.e. set `{SAMPLES: 300}`.
2. Set two `[TRACE] LIST` tags:
  - For Marker 1 that acts as a restart marker:  
`{MARKER LIST 1: 0:1; 10:0; 299:0}`
  - For Marker 2 that marks each frame start:  
`{MARKER LIST 2: 0:1; 10:0; 99:0}`
3. Do not use the `CONTROL LENGTH` tag.

The length of the repeated patterns is determined by the last sample number in the `[TRACE] LIST` that is the last `{Pos:State}`.

**Example: CONTROL LENGTH tag and trace processing**

In the example below, use the same marker traces and set the `CONTROL LENGTH` tag, for example `{CONTROL LENGTH: 150}`.

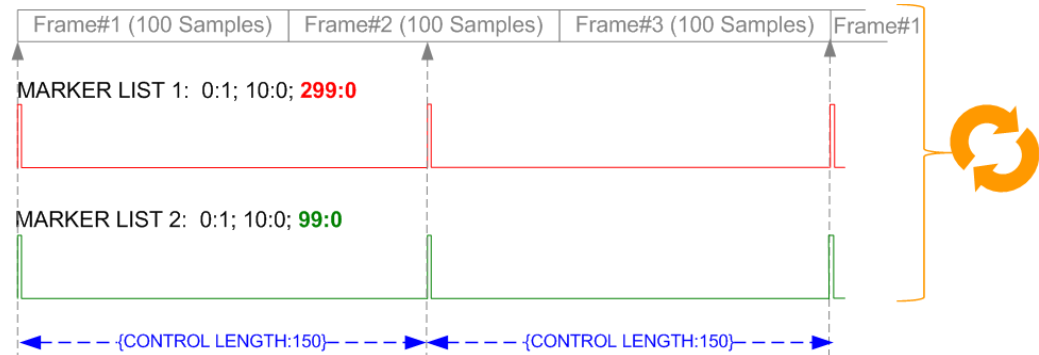

Figure 5-23: Example: Processing control signals with `CONTROL LENGTH` tag

The length of **all** control signals is determined by the `CONTROL LENGTH`. Observe how the marker traces are processed. In this example, both marker traces are repeated every 150 samples.

#### 5.7.4.7 Creating control lists with tag file format

The R&S SMW200A provides the following ways to create a file containing control signals:

- To use the dedicated "Control Data Editor" and create a file in ASCII format and with an extension `*.dm_iqc`.
- To use the tag-oriented format and create a data list file, see ["To create a data list with tag file format"](#) on page 334.
- To use SCPI commands and create a file in binary format, see ["To create a data list in binary format"](#) on page 334.

#### To create a control list with tag file format

To create an ASCII control list file directly, use the provided tag commands.

1. Use a hex data editor.
2. Create the **mandatory** tags:
  - `TYPE`
  - `[TRACE] LIST`

The `[TRACE] LIST` tag defines the individual markers or control traces in a combined `{Pos:State}` way within the control list period (`CONTROL LENGTH`).

3. Create the **recommended** tag `CONTROL LENGTH`.  
This tag defines the periodicity of the total control list.
4. Add required optional tags.

Insert these tags after the `TYPE` tag in arbitrary order.

For example, the control list file contains the following information:

```
{TYPE:SMU-CL}{COPYRIGHT:Rohde&Schwarz}
{DATE:2012-06-11;15:00:09}{HOP LIST:0:0;498:1;506:0}
{CW MODE LIST:0:0;380:1}{LEVATT LIST 3:0:0;464:1}
{BURST LIST:0:0;122:1;270:0;582:1;924:0}
{MARKER LIST 4:0:0;706:1;764:0}
{MARKER LIST 3:0:0;530:1;633:0}
{MARKER LIST 2:0:0;350:1;457:0}
{MARKER LIST 1:0:0;108:1;160:0}
{CONTROL LENGTH:1000}
```

The [Figure 5-16](#) shows the representation of the created control list in the "CList" data editor dialog.

Compare the displayed ramp values of "Marker 1" and the "Total List Length" with the values in the corresponding tags.

**Note:** In the provided example, the tags have been separated by line breaks for better reading.

See also [Example "To assign and activate control signals"](#) on page 333.

### To create a control list in binary format

Generation of a control list in binary format is not necessary but possible.

- ▶ Use the commands `BB:DM:CLIST:...` to generate a control list in binary format (see ["Handling list files"](#) on page 1086 and the example in `[ :SOURCE<hw> ] :BB:DM:CLIST:DATA` on page 1090).

See also [Example "To assign and activate control signals"](#) on page 333.

### Example: To assign and activate control signals

**Note:** Irrespectively on the way they are created, generated control lists are not automatically used.

We assume that a control list `clist.dm_iqc` containing information on marker 2, burst gate and level attenuation control signals is created and saved in the directory `/var/user/temp/`.

The following example shows how to enable the R&S SMW200A to:

- Use the control list for a particular marker output, for example "Custom Digital Mod" > "Marker 1".
- Use the Burst Gate and Level Attenuation control signals as defined in a control list.

```
MMEM:CDIRectory "/var/user/temp"
SOURCE1:BB:DM:CLIST:CATalog?
// Response: clist
SOURCE1:BB:DM:CLIST:SElect "clist"
SOURCE1:BB:DM:TRIGger:OUTPut1:MODE CLIST
SOURCE1:BB:DM:PRAMP:SOURCE INTERNAL
```

### 5.7.4.8 Creating data lists with tag file format

The R&S SMW200A provides the following ways to create a data list file:

- To use the dedicated "Data List Editor" and create a file with extension \*.dm\_iqd, see ["To create data lists manually"](#) on page 290.
- To use the tag-oriented format and create a data list file, see ["To create a data list with tag file format"](#) on page 334.
- To use SCPI commands and create a file in binary format, see ["To create a data list in binary format"](#) on page 334.

#### To create a data list with tag file format

1. Use a hex data editor.
2. Create the mandatory tags: {TYPE}, {DATA BITLENGTH} and {DATA LIST}
3. Consider the tag syntax and rules.

The following is an example of the data list file content. The tags are separated by line breaks for better reading. The text in brackets is short explanation.

For details, see the tag description:

- TYPE
- {DATA BITLENGTH}
- {DATA LIST-Length}

```
{TYPE:SMU-DL}{COPYRIGHT:Rohde&Schwarz}
{DATE:201-06-11;15:00:09}
{DATA BITLENGTH: 8}
{DATA LIST-2: #d0d1...d7}
```

(1 byte containing 8 data bits d0 to d7 in binary format, where d0 is the MSB)

See also:

- [Figure 5-17](#) for representation of the created data list in the "Data List Editor".
- [Example "To assign and activate a data list"](#) on page 335

#### To create a data list in binary format

- ▶ Use the commands `BB:DM:DLIST:....`  
See ["Handling list files"](#) on page 1086.

```
MMEM:CDIRectory "/var/user"
// Create a new data list file.
SOURCE1:BB:DM:DLIST:SElect "dl_new"
// Append data to the data list and query the content.
FORMat ASCii
SOURCE1:BB:DM:DLIST:DATA:APPend 0,1,1,1,0,1,0,1
SOURCE1:BB:DM:DLIST:DATA?
// Response: 0,1,1,1,0,1,0,1
```

See also [Example "To assign and activate a data list"](#) on page 335.

**Example: To assign and activate a data list**

We assume, that a created data list file `dl.dm_iqd` in the directory `/var/user/`. The following example shows how to use this data list as data source for the custom digital modulation.

```
MMEM:CDIRectory "/var/user"
SOURce1:BB:DM:DLISt:CATalog?
// Response: dl
SOURce1:BB:DM:DLISt:SElect "dl"
```

**5.7.4.9 Editing waveform files, data and control lists**

You can edit the internally and externally crated waveform files, data and control lists. The waveform, data and control lists files contain binary and ASCII data.

Consider the following rules while editing files with binary data.

**Rules for editing binary data**

- **Use hex data editor**  
Always use a hex data editor to edit files containing binary data. Editing of binary data file with a text editor, even if you only change the ASCII part of the file, corrupts the file.
- **Adapt the length information in the {EMPTYTAG}**  
If you change the content of a waveform file, change also the {EMPTYTAG-Length} value.  
For example, change this value, if you add a tag or add bytes to an existing tag. Reduce the value by the number of newly introduced bytes.

**5.7.5 Tags for waveforms, data and control lists**

The instrument uses a simple tag-oriented format for externally or internally generated waveforms, data and control lists. Files with this format can be transmitted from an external computer to the instrument and vice versa.

The instrument transmits these files as a binary data block, using the following SCPI command:

- `[ :SOURce<hw> ] :BB:ARBitrary:WAVeform:DATA`
- `[ :SOURce<hw> ] :BB:DM:DLISt:DATA`
- `[ :SOURce<hw> ] :BB:DM:CLISt:DATA`

You can transmit files via the GPIB interface of the instrument.

**Tag general format**

Tags are self-contained information units, enclosed in braces `{ }`. Their general format is `{Name: Data}` or `{Name-Length: Data}`. The colon separates the name part and the data part. The colon can be followed by a space for the sake of readability.

- The **Name** identifies the tag. It is always expressed in capital letters.

- The **Data** is tag-specific, and usually it is in ASCII plain text.
- The **Length** specifies the number of bytes in a `WAVEFORM` tag, `DATA LIST` tag, or `EMPTYTAG`.  
Length is an ASCII integer value, defining the number of bytes from the colon `:` to the end brace `}`

### Rules

Each waveform file must begin with the `TYPE` tag. The sequence of the remaining tags is arbitrary. For each tag, an indication shows whether it must be included in the file concerned (mandatory) or can be included (optional).

Unknown tags are not analyzed by the R&S SMW200A; they are left unchanged and saved without an error message for a possible further read back.

R&S SMU waveforms can also be loaded on the instrument, where they are converted internally into an R&S SMW200A waveform.



In all examples of file contents listed in this section, the tags have been separated by line breaks for better reading.

### Tag description

This section describes the **mandatory TYPE tag** followed by a description of all other tags, grouped per file type and listed in an alphabetical order. Some tags are valid for all three file types. If a tag is valid only for a single file type, e.g. only for a waveform, this fact is indicated in the description.

### Related step-by-step descriptions

See:

- [Section 5.7.4.6, "Defining periodically repeating traces"](#), on page 331
- [Section 5.7.4.5, "Creating waveforms with tag file format"](#), on page 326
- [Section 5.7.4.7, "Creating control lists with tag file format"](#), on page 332
- [Section 5.7.4.8, "Creating data lists with tag file format"](#), on page 334
- [Section 5.7.4.9, "Editing waveform files, data and control lists"](#), on page 335

### Supported tags:

- [Common tags](#)..... 336
- [Tags for waveforms](#)..... 339
- [Tags for multi-segment waveforms](#)..... 345
- [Tags for data lists](#)..... 350
- [Tags for control lists](#)..... 351

#### 5.7.5.1 Common tags

The following tags are common to all file types. For all tags, see "[Supported tags:](#)" on page 336.



**Common tags**

{TYPE: magic, xxxxxxxx}.....	337
{COMMENT: string}.....	338
{COPYRIGHT: string}.....	338
{DATE: yyyy-mm-dd;hh:mm:ss}.....	338

**{TYPE: magic, xxxxxxxx}****(mandatory, must be the first tag in the file)**

Identifies the file as a valid R&S SMW200A file. It must be present and must be the first in the waveform. If a file of the same name exists on the target medium, it is overwritten.

**Setting parameters:**

magic Designates the file type and has the following values:

**SMU-WV**

A valid R&S SMW200A waveform.

**SMU-MWV**

A valid R&S SMW200A multi-segment waveform.

**SMU-DL**

A valid R&S SMW200A data list.

**SMU-CL**

A valid R&S SMW200A control list.

xxxxxxx

Is an ASCII-coded checksum of the data part of the `WAVEFORM` tag in the file. This value is always 0 for data lists and control lists.

The checksum for waveforms is used for detecting transmission errors. If the `TYPE` tag contains 0 or a non-numeric value for the checksum, it is ignored.

It is calculated in accordance with the algorithm given below, where:

`start` is a pointer to the first byte after the `#` character in the `WAVEFORM` tag

`length` is the number of bytes between `start` and the closing curly bracket (excluding the latter; `length` must be divisible by 4 without a remainder.

```
UINT32 checksum(void *start, UINT32 length)
{
    UINT32 i, result = 0xA50F74FF;
    for(i=0; i < length/4; i++)
        result = result ^ ((UINT32 *)start)[i];
    return(result);
}
```

The checksum is currently not verified when waveforms are loaded.

**Example:**            {TYPE: SMU-WV,106656}  
                           BB:ARB:WAV:TAG? 'TYPE'  
 Queries the content of the TYPE tag.  
 Response: 'SMU-WV,106656'  
 This is a valid waveform.

#### **{COMMENT: string}**

The tag contains a plain text ASCII string of arbitrary length. The string is not analyzed in the R&S SMW200A. It is used to describe the file. The string is allowed to contain all printable ASCII characters except the closing curly bracket.

**Example:**            {COMMENT: File with data for 3GPP enhanced  
                           channels}  
                           BB:ARB:WAV:TAG? 'COMMENT'  
 Queries the content of the COMMENT tag of the selected waveform file.  
 Response: 'File with data for 3GPP enhanced  
 channels'  
 The comment on the waveform reads "File with data for 3GPP enhanced channels".

**Usage:**             Setting only

#### **{COPYRIGHT: string}**

The tag contains an ASCII string of arbitrary length. The string is not analyzed in the R&S SMW200A. It is used to save copyright information about the file content.

**Example:**            {COPYRIGHT: Rohde&Schwarz}  
                           BB:ARB:WAV:TAG? 'COPYRIGHT'  
 Queries the content of the COPYRIGHT tag of the selected waveform file.  
 Response: 'Rohde&Schwarz'  
 Copyright resides with Rohde & Schwarz.

**Usage:**             Setting only

#### **{DATE: yyyy-mm-dd;hh:mm:ss}**

**(optional)**

The tag contains the date and time at which the file was created. Enter the year as four digits. The instrument does not analyze this tag.

**Example:**            {DATE: 2009-04-02;14:32:12}  
                           BB:ARB:WAV:TAG? 'DATE'  
 Queries the content of the DATE tag of the selected waveform file.  
 Response: '2009-04-02;14:32:12'  
 The waveform was created on April 2, 2009 at 14 hrs 32 min.

**Usage:** Setting only

### 5.7.5.2 Tags for waveforms

The following tags apply to waveforms exclusively. For all tags, see "[Supported tags:](#)" on page 336.

#### Waveform tags

{CLOCK: frequency}.....	339
{CONTROL LENGTH: ControlLength}.....	339
{EMPTYTAG-Length: #EmptySequence}.....	340
{LEVEL OFFS: RMSOffset_dB,PeakOffset_dB}.....	341
{MARKER MODE [#]: GENERATOR}.....	342
{SAMPLES: Samples}.....	343
{BURST LIST [#]: Pos0:State0; Pos1:State1; ...PosN-1:StateN-1}.....	343
{CW MODE LIST [#]: Pos0:State0; Pos1:State1; ...PosN-1:StateN-1}.....	343
{HOP LIST [#]: Pos0:State0; Pos1:State1; ...PosN-1:StateN-1}.....	343
{LEVATT LIST [#]: Pos0:State0; Pos1:State1; ...PosN-1:StateN-1}.....	343
{MAP LIST [#]: Pos0:State0; Pos1:State1; ...PosN-1:StateN-1}.....	343
{MARKER LIST [#]: Pos0:State0; Pos1:State1; ...PosN-1:StateN-1}.....	343
{[TRACE] LIST [#]: Pos0:State0; Pos1:State1; ...PosN-1:StateN-1}.....	343
{WAVEFORM-Length: #I0Q0I1Q1...IxQx...IN-1QN-1...}.....	344

---

#### {CLOCK: frequency}

##### (mandatory for waveforms)

The tag specifies the clock frequency at which the waveform has to be output, in Hz (on multi-segment waveforms this tag contains the maximal clock of all segments).

A query of `ARB:CLOCK?` after loading the waveform returns the value set using the `CLOCK` tag. This value can later be altered with the command `ARB:CLOCK?`.

**Example:**

```
{CLOCK: 54000000}
BB:ARB:WAV:TAG? 'CLOCK'
```

Queries the content of the `CLOCK` tag.

```
Response: 54000000
```

The clock frequency is set to 54 MHz.

**Usage:** Setting only

---

#### {CONTROL LENGTH: ControlLength}

##### (optional / recommended for marker and control lists)

The tag specifies the length of *all* control or marker list in ASCII format.

The control length influences the way the marker and control lists are processed, in particular the way traces are repeated; see [Figure 5-24](#).

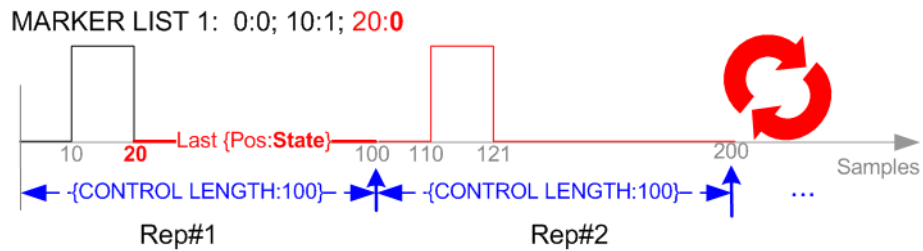

Figure 5-24: Example: Processing of MARKER TRACE if CONTROL LENGTH is specified

If the CONTROL LENGTH tag is not used, the marker and control list length are determined by the last position, that is the last {Pos:State} couple, defined in the particular [TRACE] LIST tag; see Figure 5-25.

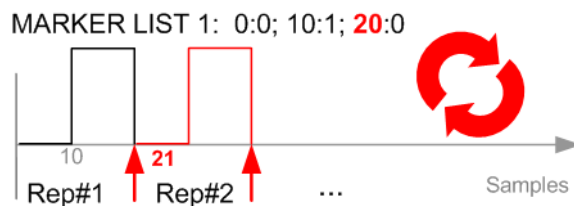

Figure 5-25: Example: Processing of MARKER TRACE if CONTROL LENGTH is not used

To maintain marker signals and waveform data synchronized, set the CONTROL LENGTH to be equal to the number of samples specified with the tag SAMPLES.

See also Section 5.7.4.6, "Defining periodically repeating traces", on page 331.

**Example:**

```
{CONTROL LENGTH: 500}
SOURCE:BB:ARBITRARY:CLIST:TAG? 'CONTROL LENGTH'
Queries the length of the control list.
Response: 500
```

**Manual operation:** See "Total List Length" on page 286

### {EMPTYTAG-Length: #EmptySequence}

(mandatory in automatically generated one and multi-segment waveforms)

This tag is empty, i.e. contains no data, and is used as placeholder.

#### Setting parameters:

**Length** An ASCII integer value that specifies the number of bytes in the EMPTYTAG, i.e. defines the number of bytes from the colon : to the end brace }

**Note:** If you change the content of a waveform file, change also the {EMPTYTAG-Length} value. For example, if you add a tag or add bytes to a tag, reduce the length by the number of newly introduced bytes.

**EmptySequence** An empty sequence containing blanks only. The number of used blanks is calculated as the difference between the hex addresses of the {WAVEFORM} tag and the hash sign # in the {EMPTYTAG}.

The {WAVEFORM} tag always starts at hex address #4000.

**Example:**

```
{TYPE:SMU-WV, 837236424}
{COPYRIGHT:2003 Rohde&Schwarz SMU}
{DATE:2012-07-11;14:38:01}
{SAMPLES:80000}
{CLOCK:86666666.666666666}
{VECTOR MAX:1.000000038569158}
{LEVEL OFFS:3.333553817875577e-07,0}
{MARKER LIST 1:0:1;1:0;1249:0}
{MARKER LIST 2:0:1;1:0;1249:0}
{MARKER LIST 3:0:1;1:0;1249:0}
{MARKER LIST 4:0:1;1:0;1249:0}
{EMPTYTAG-15947:# ...}
{WAVEFORM-320017:#IQIQIQ...}
```

The example waveform file contains 436 (0x1b4) bytes before the # sign in the EMPTYTAG; the hex address of the # sign is 0x1b5. The {WAVEFORM} starts at 0x4000. The EMPTYTAG contains 15946 blanks and has a length of (15946+1) bytes.

**Usage:** Setting only

---

**{LEVEL OFFS: RMSOffset\_dB,PeakOffset\_dB}**

**(recommended for waveforms)**

The tag determines the level of the ARB signal in the waveform file. The offset levels define the offset of RMS and peak value relative to the 16-bit full scale modulation (-32767 to + 32767) = 0 dB.

**Setting parameters:**

**RMSOffset\_dB** Defines the RMS level offset of the signal relative to full scale ARB signal in the WAVEFORM tag. The offset is defined in ASCII float format. The value is always positive.  
A 3 dB value indicates that the RMS level of the signal is 3 dBs below the full scale.  
full scale = max. amplitude of vector of I/Q samples =  $|S_{IQ}|_{max} = \sqrt{I^2+Q^2}_{max} = 0$  dB

**PeakOffset\_dB** Defines the peak level offset of the signal relative to full scale for the ARB signal in the WAVEFORM tag. The offset is defined in ASCII float format.  
The value usually equals 0 dB as usually the I/Q samples (signed 16-bit integer values) are modulated to full scale: Full scale = 0 dB = max. amplitude of vector of I/Q samples =  $|S_{IQ}|_{max} = \sqrt{I^2+Q^2}_{max} = (2^{15})-1 = 32767$ .

A positive `PeakOffset_dB` value indicates that a headroom to full scale is provided when generating the waveform. A negative `PeakOffset_dB` value indicates that overrange is likely for some samples, i.e. clipping might occur.

The crest factor can be calculated from the two values as follows:

$$\text{Crest Factor} = |\text{PeakOffset\_dB} - \text{RMSOffset\_dB}|$$

**Example:**

```
{LEVEL OFFS: 3.45,2}
```

```
BB:ARB:WAV:TAG? 'LEVEL OFFS'
```

Queries the content of the `LEVEL OFFS` tag of the selected waveform file.

```
Response: 3.45,2
```

The level of the waveform is below full scale, clipping does not occur.

**Usage:**

Setting only

**{MARKER MODE [#]: GENERATOR}****(Optional for waveforms)**

The tag defines how the marker signals are generated. The tag is included in the waveforms, created by the R&S WinIQSIM2 software.

- Tag not used

The marker signals defined with the tag `MARKER LIST` are converted into a separate binary control list. When the waveform is loaded into the ARB, this control list is also loaded automatically and processed synchronous with the waveform.

**Note:** This method reduces the maximum waveform length (given as number of samples). The number of available samples is limited, because each marker requires 4 bits per I/Q sample, additionally to the 32 bits required to describe an I/Q sample.

- Tag is used

The marker signals defined with the tag `MARKER LIST` are processed internally; additional control list is not created. If the tag is used for **all 3 markers**, the whole ARB memory is available for the I/Q samples.

**Note:** If this tag is used, the maximum number of marker states defined with the tag `MARKER LIST` is 64, i.e. `Pos63:State63`

**Setting parameters:**

`[#]` 1 to 3

Sets the marker number.

**Example:**

```
{MARKER MODE 1: GENERATOR}
```

```
{MARKER MODE 2: GENERATOR}
```

```
{MARKER MODE 3: GENERATOR}
```

**Usage:**

Setting only

**{SAMPLES: Samples}****(recommended for waveforms)**

The tag contains the number of I/Q samples in the waveform in ASCII format.

On multi-segment waveforms, this tag contains the total I/Q samples of all segments.

**Example:**                    {SAMPLES: 1000}  
                                   BB:ARB:WAV:TAG? 'SAMPLES'  
                                   Queries the content of the SAMPLES tag of the selected waveform file.  
                                   Response: 1000  
                                   The waveform contains 1000 I/Q samples.

**Usage:**                    Setting only

See also [Section 5.7.4.6, "Defining periodically repeating traces"](#), on page 331.

---

**{BURST LIST [#]: Pos0:State0; Pos1:State1; ...PosN-1:StateN-1}**  
**{CW MODE LIST [#]: Pos0:State0; Pos1:State1; ...PosN-1:StateN-1}**  
**{HOP LIST [#]: Pos0:State0; Pos1:State1; ...PosN-1:StateN-1}**  
**{LEVATT LIST [#]: Pos0:State0; Pos1:State1; ...PosN-1:StateN-1}**  
**{MAP LIST [#]: Pos0:State0; Pos1:State1; ...PosN-1:StateN-1}**  
**{MARKER LIST [#]: Pos0:State0; Pos1:State1; ...PosN-1:StateN-1}**  
**{[TRACE] LIST [#]: Pos0:State0; Pos1:State1; ...PosN-1:StateN-1}**

**(mandatory for control lists / optional for waveforms)**

The tag contains the data for the marker and control signals in the control list or the marker signals of ARB waveforms.

Depending on the control length, the instrument processes traces differently, see [{CONTROL LENGTH: ControlLength}](#) on page 339.

How to: [Section 5.7.4.6, "Defining periodically repeating traces"](#), on page 331

Also, the processing of the marker traces (MARKER LIST) depends on the presence of the marker mode tag. See [{MARKER MODE \[#\]: GENERATOR}](#) on page 342.

**Setting parameters:**

[TRACE]                    MARKER | BURST | LEVATT | CW MODE | HOP | MAP  
                                   Name of the marker or control signal.  
                                   For ARB waveforms, it is only meaningful to define marker signals; in the ARB multi-segment waveforms these tags are ignored.

[#]                         1 to 3  
                                   Sets the marker or control trace number; supported is only LEVATT LIST 1.

<b>Pos</b>	Specifies in ASCII format the position (i.e. sample number or data value), with the effect from which the binary <i>State</i> of the marker or of the control signal changes. If you use the marker mode tag, the maximum number of marker states is 64, i.e. Pos <sub>63</sub> :State <sub>63</sub> . See { <a href="#">MARKER MODE [#]: GENERATOR</a> } on page 342.
<b>State</b>	0   1 Specifies the binary state of the marker or of the control signal from Pos <sub>N</sub> to Pos <sub>N+1</sub> exclusive in ASCII format.
<b>Example:</b>	<pre>{MARKER LIST 1: 0:0;10:1;20:0;30:1} BB:DM:CLIS:TAG? 'MARKER LIST 1'</pre> <p>Queries the content of the <code>MARKER LIST 1</code> tag of the selected control list file.</p> <p>Response: '0:0;10:1;20:0;30:1'</p> <p>The marker setting for samples 0 to 9 = 0 (low), for 10 to 19 = 1 (high) and for 20 to 29 = 0. From sample 30 onward, the marker setting is 1 (high).</p>
<b>Example:</b>	<pre>{LEVATT LIST 1: 0:0;10:1;20:0;30:1} BB:DM:CLIS:TAG? 'LEVATT LIST 1'</pre> <p>Queries the content of the <code>LEVATT LIST 1</code> tag of the selected control list file.</p> <p>Response: '0:0;10:1;20:0;30:1'</p> <p>Level attenuation applies to data values 10 to 19 (high) and from data value 30 onward.</p>
<b>Usage:</b>	Setting only
<b>Manual operation:</b>	See " <a href="#">Select Ramp to Edit</a> " on page 286

---

### {WAVEFORM-Length: #I0Q0I1Q1...IxQx...IN-1QN-1...}

#### (mandatory for waveforms)

The tag contains the actual waveform data or multi-segment waveform data (I/Q stream). See [Section 5.10, "Generating multi-segment waveform files"](#), on page 360 for background information description of the multi-segment waveform function.

#### Setting parameters:

<b>Length</b>	Sets the number of bytes in a <code>WAVEFORM</code> tag and is calculated as follows: $\text{Length} = \text{Number of I/Q pairs} * 4 \text{ (2 bytes per I and 2 bytes per Q value)} + 1 \text{ byte (the length of the \#)}$
<b>IxQx</b>	<code>IxQx...</code> represents binary data (16-bit signed integer in 2's complement notation) containing the I and Q component alternately and starting with the I component. Each component consists of 2 bytes in little endian format representation, i.e the least significant byte (LSB) first.



## Using the arbitrary waveform generator (ARB)

The values of the 2 bytes in an I component and a Q component are in the range 0x0 to 0xFFFF (-32767 to +32767). This value is transferred to the D/A converter.

This tag is also used to store multi-segment waveforms. The I/Q streams of the individual waveforms are directly concatenated to one collective waveform I/Q stream.

The number of segments and the start offset and length of the individual segments inside the total waveform I/Q stream is determined by the additional tags `MWV_SEGMENT_COUNT`, `MWV_SEGMENT_START`, and `MWV_SEGMENT_LENGTH`.

Further `MWV_SEGMENT_ . . .` tags are also available, for example for level and clock information.

**Example:****One segment waveform**

```
{WAVEFORM-401:#I0,Q0,I1,Q1,I2,Q2,...I99,Q99}
```

100 I/Q pairs with 4 bytes each are transmitted - none multi-segment.

**Example:****Multi-segment waveform**

```
{WAVEFORM-1201:
```

```
#I0,Seg0,Q0,Seg0,I1,Seg0,Q1,Seg0,...I99,Seg0,Q99,Seg0,I0,Seg1,Q0,Seg1,I1,Seg1,Q1,Seg1,...I199,Seg1,Q199,Seg1}
```

2 segments: segment 0 with 100 I/Q pairs; segment 1 with 200 I/Q pairs. Each I/Q pair consists of 2\*16 bites = 4 bytes.

The data is transmitted using the SCPI command [ :  
`SOURce<hw>]:BB:ARBitrary:WAVeform:DATA.`

**Usage:**

Setting only

**5.7.5.3 Tags for multi-segment waveforms**

The following tags apply to multi-segment waveforms exclusively. For all tags, see "Supported tags:" on page 336.

**Multi-segment waveform tags**

<code>{MWV_SEGMENT_COUNT: NumOfSeg}</code> .....	346
<code>{MWV_SEGMENT_DURATION: SegDur0, SegDur1, ..., SegDurN-1}</code> .....	346
<code>{MWV_SEGMENT_LENGTH: SamplesSeg0, SamplesSeg1, ..., SamplesSegN-1}</code> .....	346
<code>{MWV_SEGMENT_START:</code>	
<code>SampleStartOffsetSeg0, SampleStartOffsetSeg1, ..., SampleStartOffsetSegN-1}</code> .....	346
<code>{MWV_SEGMENT_CLOCK_MODE: Mode}</code> .....	347
<code>{MWV_SEGMENT_CLOCK: ClockSeg0, ClockSeg1, ..., ClockSegN-1}</code> .....	347
<code>{MWV_SEGMENT_LEVEL_MODE: Mode}</code> .....	347
<code>{MWV_SEGMENT_LEVEL_OFFS:</code>	
<code>RMSOffs_dBSg0,PeakOffs_dBSg0, ..., RMSOffs_dBSgN-1, PeakOffs_dBSgN-1}</code> .....	348
<code>{MWV_SEGMENT_SETTINGS_FILE: SegSettingFilePath}</code> .....	348
<code>{MWV_SEGMENT_FILES:</code>	
<code>"FileNameSeg0.wv", "FileNameSeg1.wv", ..., "FileNameSegN-1.wv"</code> .....	349
<code>{MWV_SEGMENTx_COMMENT: text}</code> .....	349
<code>{CONTROL LIST WIDTH4-Length: #m0m1...mx...mM-1}</code> .....	349

---

**{MWV\_SEGMENT\_COUNT: NumOfSeg}****(mandatory for multi-segment waveforms)**

The tag contains the number of segments in the multi-segment waveform in ASCII integer format.

**Example:**                    {MWV\_SEGMENT\_COUNT: 2}  
Multi-segment waveform with 2 segments

**Usage:**                    Setting only

---

**{MWV\_SEGMENT\_DURATION: SegDur0, SegDur1, ..., SegDurN-1}****(optional for multi-segment waveforms)**

The tag gives the time duration (in seconds) per segment.

**Example:**                    {MWV\_SEGMENT\_DURATION: 1, 0.5}  
Multi-segment waveform with 2 segments, lasting 1 s and 0.5 s each.

**Usage:**                    Setting only

---

**{MWV\_SEGMENT\_LENGTH: SamplesSeg0, SamplesSeg1, ..., SamplesSegN-1}****(mandatory for multi-segment waveforms)**

The tag contains a list of I/Q sample lengths for every segment in the multi-segment waveform in ASCII integer format.

**Example:**                    {MWV\_SEGMENT\_LENGTH: 100, 200}  
2 segments: 100 samples in segment 0 and 200 samples in segment 1.

**Usage:**                    Setting only

---

**{MWV\_SEGMENT\_START:****SampleStartOffsetSeg0, SampleStartOffsetSeg1, ..., SampleStartOffsetSegN-1}****(mandatory for multi-segment waveforms)**

The tag contains a list of I/Q sample start offsets for every segment in the multi-segment waveform in ASCII integer format.

**Example:**                    {MWV\_SEGMENT\_START: 0, 100}  
2 segments with 100 samples in segment 0 and 200 samples in segment 1.  
The start offset of first segment is 0 samples, start offset of next segment 1 is the sample length of segment 0 = 100 samples.

**Usage:**                    Setting only

---

---

**{MWV\_SEGMENT\_CLOCK\_MODE: Mode}**

**(mandatory for multi-segment waveforms)**

The tag contains a string in ASCII format which supplies the clock rate mode. The calculation of the multi-segment output waveform uses this clock rate mode. See also "Clock" on page 373.

The tag `CLOCK` contains always the highest clock rate of all segments. The tag `MWV_SEGMENT_CLOCK` contains the clock rates of the individual segments.

**Setting parameters:**

Mode

**UNCHANGED**

The segments can have different clock rates; each segment is output with the clock rate defined in its waveform file.

**HIGHEST**

All segments are output at the highest available clock rate.

**USER**

All segments are output at the clock rate defined by the user.

**Note:** Only upsampling is allowed, no downsampling.

**Example:**

`{MWV_SEGMENT_CLOCK_MODE: UNCHANGED}`

**Usage:**

Setting only

---

**{MWV\_SEGMENT\_CLOCK: ClockSeg0, ClockSeg1, ..., ClockSegN-1}**

**(mandatory for multi-segment waveforms)**

The tag contains a list of clock frequencies for every segment in the multi-segment waveform in ASCII floating point format.

**Example:**

`{MWV_SEGMENT_CLOCK: 100e6,80e6}`

2 segments: clock of segment 0 is 100 MHz, the clock of segment 1 is 80 MHz.

**Note:** If the segments have different clock frequencies, there are some restrictions on signal output, i.e. seamless switching between segments is only possible, if all segments have the same clock frequency. Software resampling (upsampling) can be used to bring all segments to the same clock.

**Usage:**

Setting only

---

**{MWV\_SEGMENT\_LEVEL\_MODE: Mode}**

**(optional for multi-segment waveforms)**

The tag contains a string in ASCII format which supplies the clock rate mode, that was used for calculation of the multi-segment output waveform.

See also "Level" on page 373.

#### Setting parameters:

**Mode** **UNCHANGED**  
Concerning the level settings, the segments are output exactly as defined in the individual files.  
The value displayed with the parameter "Task bar > Level" applies only to the segment with the highest RMS value. The remaining segments are output at a lower level than the displayed value.

**EQUALRMS**  
Segments are output so that all segments have the same RMS value. The value displayed with the parameter "Task bar > Level" applies to all segments.

**Example:** `{MWV_SEGMENT_LEVEL_MODE: UNCHANGED}`

**Usage:** Setting only

**{MWV\_SEGMENT\_LEVEL\_OFFS:  
RMSOffs\_dBSg0,PeakOffs\_dBSg0, ..., RMSOffs\_dBSgN-1, PeakOffs\_dBSgN-1}**

**(mandatory for multi-segment waveforms)**

The tag contains a list of level pairs in ASCII floating point format, one pair for every segment in the multi-segment waveform. The first value of a level pair defines the rms offset and the second value the peak offset relative to the 16-bit full-scale modulation (-32767; + 32767) = 0 dB. The meaning of one level value pair is the same as in the [LEVEL OFFS](#) tag for normal waveforms.

**Example:** `{MWV_SEGMENT_LEVEL_OFFS: 3.0,0.0,6.0,0.0}`  
2 segments: The RMS level of segment 0 is 3 dB below full scale; RMS level of segment 1 is 6dB below full scale.  
The peak level of both segments is 0 dB full scale.

**Usage:** Setting only

**{MWV\_SEGMENT\_SETTINGS\_FILE: SegSettingFilePath}**

**(optional for multi-segment waveforms)**

The tag contains the file path and filename of the multi-segment file, used for the calculation of the multi-segment waveform.

**Example:** `{MWV_SEGMENT_SETTINGS_FILE:  
"/var/user/Settings.inf_mswv"}`  
Multi-segment file path and filename.

**Usage:** Setting only

**{MWV\_SEGMENT\_FILES:**

**"FileNameSeg0.wv", "FileNameSeg1.wv", ..., "FileNameSegN-1.wv"}**

**(optional for multi-segment waveforms)**

The tag contains a list of filenames for every segment in the multi-segment waveform in ASCII format.

**Example:**            {MWV\_SEGMENT\_FILES: "/var/user/temp/sine.wv",  
"/var/user/temp/rect.wv" }

**Usage:**             Setting only

**{MWV\_SEGMENTx\_COMMENT: text}****(optional for multi-segment waveforms)**

The tag contains a user comment for a specific segment  $x = [0 \dots \text{NumOfSeg}-1]$  in the multi-segment waveform in ASCII format.

**Example:**            {MWV\_SEGMENT1\_FILES: segment 1 contains a QPSK  
signal. }

**Usage:**             Setting only

**{CONTROL\_LIST\_WIDTH4–Length: #m0m1...mx...mM-1}****(optional for waveforms and multi-segment waveforms)**

The tag contains a binary marker element stream, which is output synchronously to the I/Q sample sequence. One marker element  $m_x$  consists of 4 bites, which are assigned to the 3 possible marker traces of the instrument (1 bit per marker trace). One 4-bit marker element is required for every I/Q sample in the `WAVEFORM` tag. Hence, the number of marker elements  $m$  is equal to the number of I/Q samples. The `CONTROL LENGTH` tag has to contain the number of all marker elements  $m$ .

MSB 7	Byte						LSB 1
Marker element $m_x$ (synchronous to I/Q Sample $x$ )				Marker element $m_{x+1}$ (synchronous to I/Q Sample $x+1$ )			
Marker 4	Marker 3	Marker 2	Marker 1	Marker 4	Marker 3	Marker 2	Marker 1

*Figure 5-26: Marker element in 4-bit binary format bit order*

For standard waveforms, the `MARKER_LIST x` tags are a more compact way to define markers. In principle, however, the `CONTROL_LIST_WIDTH4` format can also be used instead of the `MARKER_LIST x` tags.

For multi-segment waveforms, the `CONTROL_LIST_WIDTH4` format is required for marker definition. The binary marker streams of the individual segments are directly concatenated (without any gap) to one collective marker stream.

**Setting parameters:**

Length	Sets the number of bytes in the <code>CONTROL LIST WIDTH4</code> tag in ASCII Format and is calculated as follows: <i>Length = size of "#" (1 byte) + number of marker elements <math>m_x</math> * (4 bit) / (8 bits/byte)</i> The value is rounded up for byte alignment.
mx	Marker element in 4-bit binary format.
<b>Example:</b>	{CONTROL LIST WIDTH4-51: #m <sub>0</sub> m <sub>1</sub> ...m <sub>x</sub> ...m <sub>99</sub> } 100 marker elements, each marker element with 4 bits
<b>Usage:</b>	Setting only

**5.7.5.4 Tags for data lists**

The following tags apply to data lists exclusively. For all tags, see "[Supported tags:](#)" on page 336.

{DATA BITLENGTH: BitLength}.....	350
{DATA LIST-Length: #d0d1...dx...dN-1...}.....	350

**{DATA BITLENGTH: BitLength}****(mandatory for data lists)**

The tag defines the length of the data field in the `DATA LIST` tag in bits in ASCII format.

**Example:**                   {DATA BITLENGTH: 444}  
BB:DM:DLIS:SEL "/var/user/dl"  
BB:DM:DLIS:TAG? "dl", "DATA BITLENGTH"  
Queries the content of the `DATA BITLENGTH` tag of the selected data list file.  
Response: '444'  
The data list is 444 bits long.

**Usage:**                   Setting only

**{DATA LIST-Length: #d0d1...dx...dN-1...}****(mandatory for data lists)**

The tag contains the actual bit sequence of the data list in binary format.

**Setting parameters:**

Length	Defines the number of bytes in the <code>DATA LIST</code> tag in ASCII Format (see { <a href="#">WAVEFORM-Length: #IQ0I1Q1...IxQx...IN-1QN-1...</a> } for details).
dx	Data bits in binary format (8-bit unsigned characters, MSB first).

**Example:** {DATA LIST-17: #d0d1...dx...d127}  
 16 bytes containing 128 data bits, first bit is the MS bit of the first byte.

**Usage:** Setting only

### 5.7.5.5 Tags for control lists

The following tags apply to control lists exclusively. For all tags, see "Supported tags:" on page 336.

{CONTROL LENGTH: ControlLength}.....	351
{BURST LIST [#]: Pos0:State0; Pos1:State1; ...PosN-1:StateN-1}.....	352
{CW MODE LIST [#]: Pos0:State0; Pos1:State1; ...PosN-1:StateN-1}.....	352
{HOP LIST [#]: Pos0:State0; Pos1:State1; ...PosN-1:StateN-1}.....	352
{LEVATT LIST [#]: Pos0:State0; Pos1:State1; ...PosN-1:StateN-1}.....	352
{MAP LIST [#]: Pos0:State0; Pos1:State1; ...PosN-1:StateN-1}.....	352
{MARKER LIST [#]: Pos0:State0; Pos1:State1; ...PosN-1:StateN-1}.....	352
{[TRACE] LIST [#]: Pos0:State0; Pos1:State1; ...PosN-1:StateN-1}.....	352

#### {CONTROL LENGTH: ControlLength}

(optional / recommended for marker and control lists)

The tag specifies the length of *all* control or marker list in ASCII format.

The control length influences the way the marker and control lists are processed, in particular the way traces are repeated; see Figure 5-24.

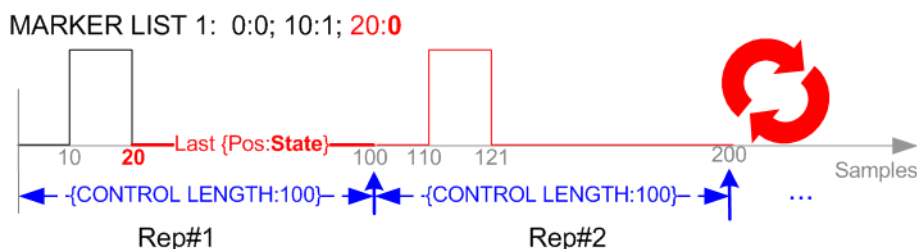

Figure 5-27: Example: Processing of MARKER TRACE if CONTROL LENGTH is specified

If the CONTROL LENGTH tag is not used, the marker and control list length are determined by the last position, that is the last {Pos:State} couple, defined in the particular [TRACE] LIST tag; see Figure 5-25.

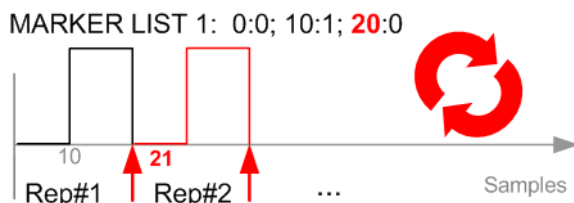

Figure 5-28: Example: Processing of MARKER TRACE if CONTROL LENGTH is not used

To maintain marker signals and waveform data synchronized, set the `CONTROL LENGTH` to be equal to the number of samples specified with the tag `SAMPLES`.

See also [Section 5.7.4.6, "Defining periodically repeating traces"](#), on page 331.

**Example:**

```
{CONTROL LENGTH: 500}
SOURCE:BB:ARBITRARY:CLIST:TAG? 'CONTROL LENGTH'
Queries the length of the control list.
Response: 500
```

**Manual operation:** See ["Total List Length"](#) on page 286

---

```
{BURST LIST [#]: Pos0:State0; Pos1:State1; ...PosN-1:StateN-1}
{CW MODE LIST [#]: Pos0:State0; Pos1:State1; ...PosN-1:StateN-1}
{HOP LIST [#]: Pos0:State0; Pos1:State1; ...PosN-1:StateN-1}
{LEVATT LIST [#]: Pos0:State0; Pos1:State1; ...PosN-1:StateN-1}
{MAP LIST [#]: Pos0:State0; Pos1:State1; ...PosN-1:StateN-1}
{MARKER LIST [#]: Pos0:State0; Pos1:State1; ...PosN-1:StateN-1}
{[TRACE] LIST [#]: Pos0:State0; Pos1:State1; ...PosN-1:StateN-1}
(mandatory for control lists / optional for waveforms)
```

The tag contains the data for the marker and control signals in the control list or the marker signals of ARB waveforms.

Depending on the control length, the instrument processes traces differently, see [{CONTROL LENGTH: ControlLength}](#) on page 339.

How to: [Section 5.7.4.6, "Defining periodically repeating traces"](#), on page 331

Also, the processing of the marker traces (`MARKER LIST`) depends on the presence of the marker mode tag. See [{MARKER MODE \[#\]: GENERATOR}](#) on page 342.

#### Setting parameters:

[TRACE]	MARKER   BURST   LEVATT   CW MODE   HOP   MAP Name of the marker or control signal. For ARB waveforms, it is only meaningful to define marker signals; in the ARB multi-segment waveforms these tags are ignored.
[#]	1 to 3 Sets the marker or control trace number; supported is only <code>LEVATT LIST 1</code> .
Pos	Specifies in ASCII format the position (i.e. sample number or data value), with the effect from which the binary <code>State</code> of the marker or of the control signal changes. If you use the marker mode tag, the maximum number of marker states is 64, i.e. <code>Pos<sub>63</sub>:State<sub>63</sub></code> . See <a href="#">{MARKER MODE [#]: GENERATOR}</a> on page 342.
State	0   1 Specifies the binary state of the marker or of the control signal from <code>Pos<sub>N</sub></code> to <code>Pos<sub>N+1</sub></code> exclusive in ASCII format.



**Example:** `{MARKER LIST 1: 0:0;10:1;20:0;30:1}`  
`BB:DM:CLIS:TAG? 'MARKER LIST 1'`  
 Queries the content of the `MARKER LIST 1` tag of the selected control list file.  
 Response: `'0:0;10:1;20:0;30:1'`  
 The marker setting for samples 0 to 9 = 0 (low), for 10 to 19 = 1 (high) and for 20 to 29 = 0. From sample 30 onward, the marker setting is 1 (high).

**Example:** `{LEVATT LIST 1: 0:0;10:1;20:0;30:1}`  
`BB:DM:CLIS:TAG? 'LEVATT LIST 1'`  
 Queries the content of the `LEVATT LIST 1` tag of the selected control list file.  
 Response: `'0:0;10:1;20:0;30:1'`  
 Level attenuation applies to data values 10 to 19 (high) and from data value 30 onward.

**Usage:** Setting only

**Manual operation:** See "[Select Ramp to Edit](#)" on page 286

## 5.8 Generating notched signals

If your instrument is equipped with the R&S SMW-K811, you can apply notched filter.



In the following, the notched filter settings are described based on the ARB functionality. The described settings also apply for:

- EUTRA/LTE
- DVB-H/T, DVB-S2/S2X
- OFDM Signal Generation
- OneWeb

### 5.8.1 Required options

The basic equipment layout for the generation of notched signals includes the following options:

- Standard or wideband baseband generator (R&S SMW-B10/-B9)
- Baseband main module (R&S SMW-B13) or wideband baseband main module (R&S SMW-B13XT)
- Option Notched Signals (R&S SMW-K811), per signal path  
 Sufficient for the generation of notched signals with the ARB  
 For the generation of notched signals with one of the digital standards, also the corresponding option:
  - Option EUTRA/LTE (R&S SMW-K55), per signal path
  - Option DVB-H/T (R&S SMW-K52), per signal path

- Option OFDM Signal Generation (R&S SMW-K114), per signal path
- Option OneWeb User-Defined Signal Generation, OneWeb Reference Signals (R&S SMW-K130/-K355), per signal path
- Frequency option (e.g. R&S SMW-B1003)

For more information, refer to the specifications document.

## 5.8.2 About the notch filters

The noise power ratio (NPR) measurement is a method for evaluating the linearity of wideband-amplifiers. The NPR measurement use notched filters that are applied on internally or externally created waveforms.

The R&S SMW200A equipped with the R&S SMW-K811 option allows you to define up to 25 notches. You can define the frequency offset and bandwidth of each notch individually. You can use frequency values with fixed resolution, where the resolution step depends on the used [Clock Frequency](#).

The notched filters settings are available for the ARB generator and four digital standards. The provided settings are identical, merely the access to the settings and the remote control commands are different.

This section describes the notched filter settings based on the ARB functionality. The described settings, however, also apply for:

- EUTRA/LTE
- DVB-H/T, DVB-S2/S2X
- OFDM Signal Generation
- OneWeb

## 5.8.3 Notch filter settings

Access:

1. If you have coupled baseband sources, enable separate baseband sources:  
Select "System Configuration" > "Fading/Baseband Config" > "BB Source Config" > "Separate Sources".
2. Select "Baseband" > "ARB" > "Notch Filter".
3. If needed, change the displayed clock frequency via "ARB" > "General" > "Clock Frequency".  
  
For example, if you need higher frequency offsets and notch bandwidth. At higher clock frequencies on the order of MHz, also the notch bandwidth and frequency offset change its resolution from kHz to MHz.
4. Set the number of notches, for example, "Number of Notches" = "3".
5. Define notch settings, for example, for the first notch:

- a) For notch#1, set "Frequency Offset" = "0 MHz" and "Notch Bandwidth" = "0.6 MHz".
  - b) For notch#1, set "State" = "On".
6. Select "Notch Filter" > "Apply" to trigger the instrument to adopt the notch filter settings.
  7. Select "ARB" > "General" > "State" > "On".

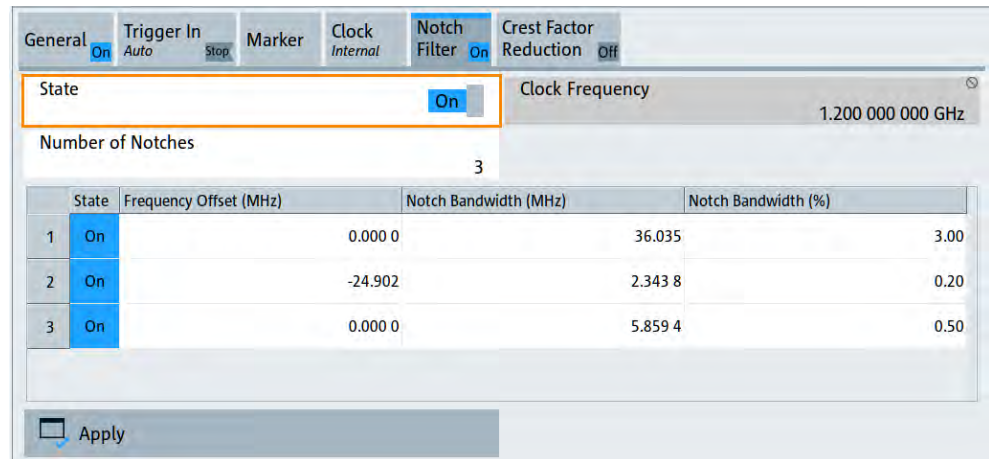

The dialog provides the settings to enable and configure the notch filters. It also displays the clock frequency for the waveform.

The remote commands required to define these settings are described in "[Notch filter commands](#)" on page 1132.

The notched filters settings are available for the ARB and four digital standards. The provided settings are identical, merely the access to the settings and the remote control commands are different.

This section describes the notched filter settings based on the ARB functionality. The described settings, however, also apply for:

- EUTRA/LTE
- DVB-H/T, DVB-S2/S2X
- OFDM Signal Generation
- OneWeb

#### Settings:

State.....	356
Clock Frequency.....	356
Number of Notches.....	356
Notch table.....	356
L State.....	356
L Frequency Offset (kHz).....	357
L Notch Bandwidth (kHz).....	357
L Notch Bandwidth (%).....	357
Apply.....	358

**State**

If enabled, the defined notch filter is applied to the baseband signal.

Remote command:

`[ :SOURce<hw> ] :BB:ARBitrary:NOTCh` on page 1133

etc. for the corresponding option:

`[ :SOURce<hw> ] :BB:DVB:NOTCh` on page 1132

`[ :SOURce<hw> ] :BB:EUTRa:NOTCh` on page 1132

`[ :SOURce<hw> ] :BB:OFDM:NOTCh` on page 1132

`[ :SOURce<hw> ] :BB:ONEWeb:NOTCh` on page 1133

**Clock Frequency**

Indicates the current clock frequency of the waveform signal.

The value equals the clock frequency of the ARB application: "ARB" > "General" > "Clock Frequency".

[Notch Bandwidth \(%\)](#) is related to this value.

Remote command:

`[ :SOURce<hw> ] :BB:ARBitrary:NOTCh:CLOCK?` on page 1133

etc. for the corresponding option:

`[ :SOURce<hw> ] :BB:DVB:NOTCh:CLOCK?` on page 1133

`[ :SOURce<hw> ] :BB:EUTRa:NOTCh:CLOCK?` on page 1133

`[ :SOURce<hw> ] :BB:OFDM:NOTCh:CLOCK?` on page 1133

`[ :SOURce<hw> ] :BB:ONEWeb:NOTCh:CLOCK?` on page 1133

**Number of Notches**

Sets the number of notches.

Set individual notches in the notch table. The number of rows equals the set number of notches. One row provides individual settings to configure one notch.

At higher clock frequencies on the order of MHz, also the notch bandwidth and frequency offset change its resolution from kHz to MHz.

Remote command:

`[ :SOURce<hw> ] :BB:ARBitrary:NOTCh:COUNt` on page 1133

etc. for the corresponding option:

`[ :SOURce<hw> ] :BB:DVB:NOTCh:COUNt` on page 1133

`[ :SOURce<hw> ] :BB:EUTRa:NOTCh:COUNt` on page 1133

`[ :SOURce<hw> ] :BB:OFDM:NOTCh:COUNt` on page 1133

`[ :SOURce<hw> ] :BB:ONEWeb:NOTCh:COUNt` on page 1133

**Notch table**

The notch table provides the settings to configure individual notch filters.

The notch filter is defined as a sequence of notches. It is described in a table form, where each table line corresponds to one notch and the number of lines is set with the parameter [Number of Notches](#).

**State ← Notch table**

Enables a single notch in the notch table.

Remote command:

[ :SOURce<hw> ] :BB:ARBitrary:NOTCh<ch>:STATe on page 1134

etc. for the corresponding option:

[ :SOURce<hw> ] :BB:DVB:NOTCh<ch>:STATe on page 1133

[ :SOURce<hw> ] :BB:EUTRa:NOTCh<ch>:STATe on page 1133

[ :SOURce<hw> ] :BB:OFDM:NOTCh<ch>:STATe on page 1133

[ :SOURce<hw> ] :BB:ONEWeb:NOTCh<ch>:STATe on page 1134

### Frequency Offset (kHz) ← Notch table

Sets the center frequency of the notch  $f_{\text{offset}}$ , where:

$$-\text{Clock Frequency}/2 < f_{\text{offset}} < + \text{Clock Frequency}/2$$

At higher clock frequencies on the order of MHz, also the notch bandwidth and frequency offset change its resolution from kHz to MHz.

Remote command:

[ :SOURce<hw> ] :BB:ARBitrary:NOTCh<ch>:FREQuency:OFFSet on page 1134

etc. for the corresponding option:

[ :SOURce<hw> ] :BB:DVB:NOTCh<ch>:FREQuency:OFFSet on page 1134

[ :SOURce<hw> ] :BB:EUTRa:NOTCh<ch>:FREQuency:OFFSet on page 1134

[ :SOURce<hw> ] :BB:OFDM:NOTCh<ch>:FREQuency:OFFSet on page 1134

[ :SOURce<hw> ] :BB:ONEWeb:NOTCh<ch>:FREQuency:OFFSet on page 1134

### Notch Bandwidth (kHz) ← Notch table

Sets the absolute notch bandwidth.

The selected value is adjusted to the internal frequency grid.

The maximum notch bandwidth is calculated as  $\text{Clock Frequency}/10$ .

At higher clock frequencies on the order of MHz, also the notch bandwidth and frequency offset change its resolution from kHz to MHz.

Remote command:

[ :SOURce<hw> ] :BB:ARBitrary:NOTCh<ch>:BWIDth[:ABSolute] on page 1134

etc. for the corresponding option:

[ :SOURce<hw> ] :BB:DVB:NOTCh<ch>:BWIDth[:ABSolute] on page 1134

[ :SOURce<hw> ] :BB:EUTRa:NOTCh<ch>:BWIDth[:ABSolute] on page 1134

[ :SOURce<hw> ] :BB:OFDM:NOTCh<ch>:BWIDth[:ABSolute] on page 1134

[ :SOURce<hw> ] :BB:ONEWeb:NOTCh<ch>:BWIDth[:ABSolute] on page 1134

### Notch Bandwidth (%) ← Notch table

Sets the notch bandwidth relative to  $\text{Clock Frequency}$ .

Remote command:

[ :SOURce<hw> ] :BB:ARBitrary:NOTCh<ch>:BWIDth:RELative on page 1135

etc. for the corresponding option:

[ :SOURce<hw> ] :BB:DVB:NOTCh<ch>:BWIDth:RELative on page 1135

[ :SOURce<hw> ] :BB:EUTRa:NOTCh<ch>:BWIDth:RELative on page 1135

[ :SOURce<hw> ] :BB:OFDM:NOTCh<ch>:BWIDth:RELative on page 1135

[ :SOURce<hw> ] :BB:ONEWeb:NOTCh<ch>:BWIDth:RELative on page 1135

**Apply**

Select "Apply" to adopt the configured settings.

Remote command:

`[ :SOURce<hw> ] :BB:ARbitrary:NOTCh:APPLY` on page 1135

etc. for the corresponding option:

`[ :SOURce<hw> ] :BB:DVB:NOTCh:APPLY` on page 1135

`[ :SOURce<hw> ] :BB:EUTRa:NOTCh:APPLY` on page 1135

`[ :SOURce<hw> ] :BB:OFDM:NOTCh:APPLY` on page 1135

`[ :SOURce<hw> ] :BB:ONEWeb:NOTCh:APPLY` on page 1135

**5.8.4 AWGN test signal settings**

Option: R&S SMW-K811.

See also [Section 5.8.1, "Required options"](#), on page 353.

Access:

1. Select "Baseband" > "ARB".
2. Select "General" > "Test Signal Form" > "AWGN".
3. Select "Create Test Signal".

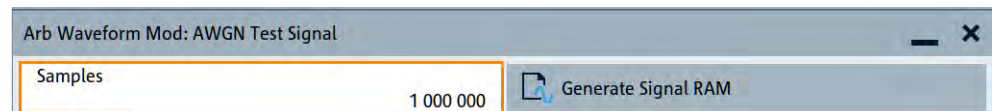

The dialog provides settings to generate an AWGN test signal waveform with a fixed number of samples.

The remote commands required to define these settings are described in [Section 14.19.5.3, "SOURce:BB:ARbitrary subsystem"](#), on page 1092.

**To generate an AWGN test signal**

1. Open the AWGN test signal settings.  
See [Section 5.8.4, "AWGN test signal settings"](#), on page 358.
2. Set the number of samples that your AWGN test signal requires.
3. Select "Generate Signal RAM".

Selecting triggers a creation of the waveform file with the set number of samples.

The filename is `awgn_test_signal_a` and the file extension is `*.wv`. Also, loads this file to the "Load Waveform ..." selection in the ARB general settings tab.

4. Close the dialog.
5. To monitor waveform properties, select "Waveform Info".

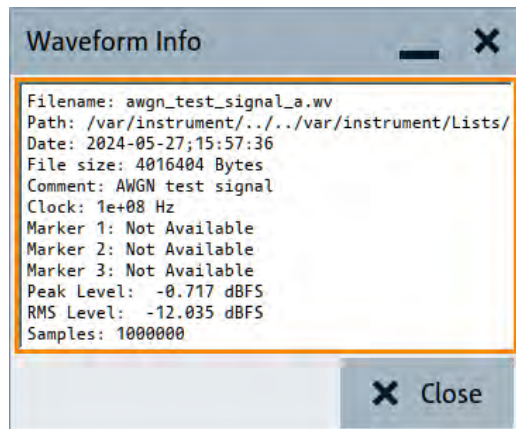

The clock frequency  $f_{\text{clock}}$  is 100 MHz per default. You can change it, see the next step.

- Optionally, adjust the clock frequency  $f_{\text{clock}}$ . The bandwidth of the resulting noise signal is approximately  $0.96 * f_{\text{clock}}$ .

**Example:** A clock frequency  $f_{\text{clock}}$  of 100 MHz results in a noise signal bandwidth of about  $0.96 * f_{\text{clock}} = 96$  MHz.

- Select "ARB > State > On" and "RF > On".

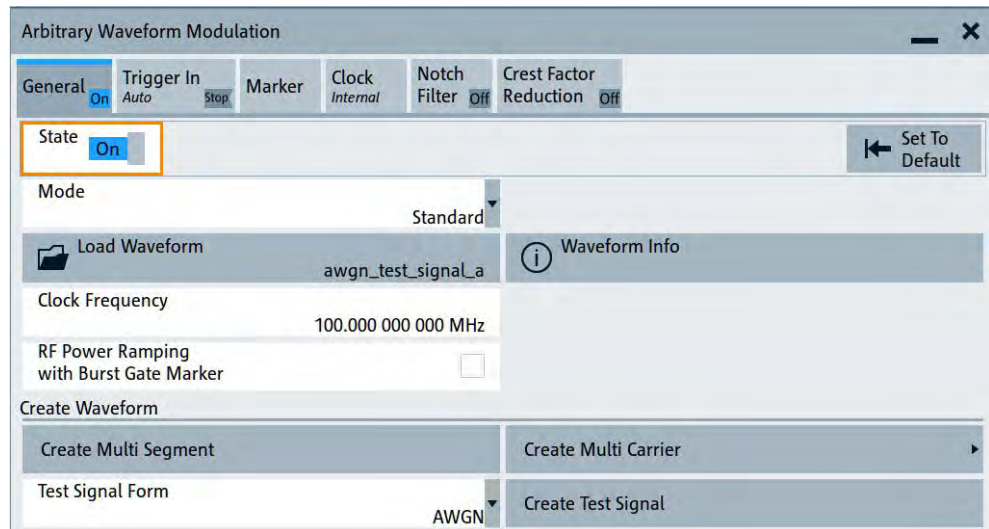

The R&S SMW200A processes the waveform file and generates an AWGN signal.

**Settings:**

Samples.....	359
Generate Signal RAM.....	360

**Samples**

Sets the number of samples generated for the AWGN waveform.

The maximum number of samples depends on the installed ARB options.

Remote command:

`[ :SOURCE<hw> ] :BB:ARbitrary:TSIGnal:AWGN:SAMPlEs` on page 1106

### Generate Signal RAM

Generates an AWGN test signal waveform. The instrument saves the file with a predefined name and loads it into the ARB.

Remote command:

`[ :SOURCE<hw> ] :BB:ARbitrary:TSIGnal:AWGN:CREate` on page 1106

## 5.9 Reducing the crest factor

Reducing the crest factor of waveforms is a function that requires the additional option Crest Factor Reduction (R&S SMW-K548).

See user manual R&S SMW-K548 Crest Factor Reduction.

## 5.10 Generating multi-segment waveform files

Modern chip technologies implement several communication standards within one chip and rise special verification and test requirements. To fulfill the requirements of these test systems and to enable rapid alternation between different waveforms with differing test signals, the R&S SMW200A provides the functionality to generate multi-segment waveform files.

This section introduces the concept of the multi-segment waveform files, together with a description of the provided settings and some typical configuration examples.

Generation of multi-segment waveform files is possible in configurations with separated baseband sources: "System Configuration" > "Fading/Baseband Config" > "BB Source Config" > "Separate Sources".

### 5.10.1 Required options

See [Section 5.7.1, "Required options"](#), on page 303.

Also, multi-segment waveform files require the corresponding digital standard options (R&S SMW-K2xx) of all included standards.

### 5.10.2 About the multi-segment waveforms

A multi-segment waveform is a composed signal that contains several multiple independent waveforms called segments. You can output each segment with its own marker and clock settings.

The figure [Figure 5-29](#) shows the principle of building a multi-segment waveform.



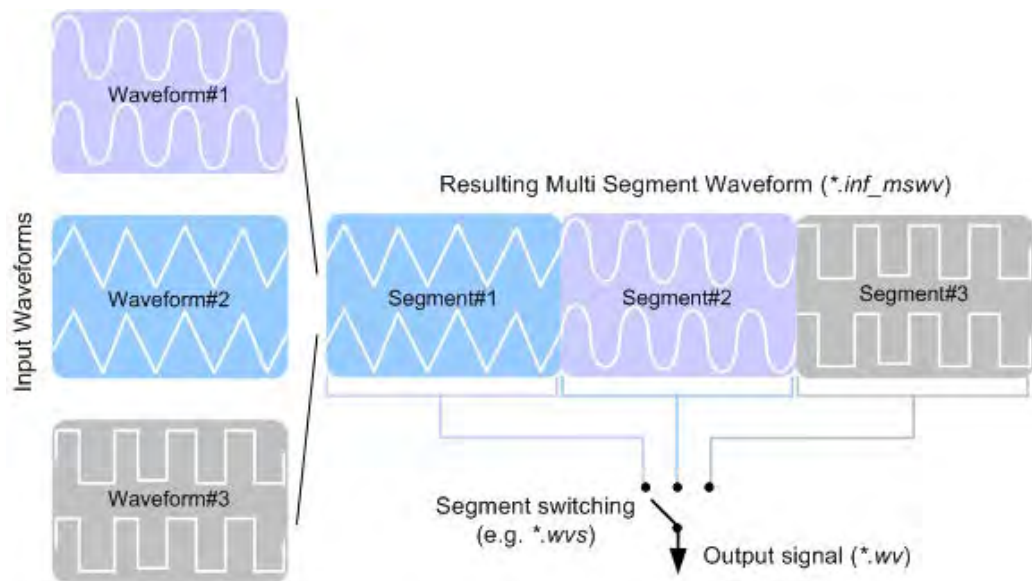

Figure 5-29: ARB multi-segment waveform concept

It is also possible to create and output a blank segment. These segments contain zero signal.

For typical applications of multi-segment waveforms, see [Section 5.10.4, "Working with multi-segment waveform files"](#), on page 382.

### 5.10.2.1 Multi-segment waveform processing

Processing of the waveform is triggered by the "Create" or "Create and Load" function. To process the waveform, the instrument loads the entire multi-segment waveform into the memory. It is therefore possible to alternate between the individual waveforms without delay due to loading. You can define the output order of the segments, and the segment intended to be output at any given moment.

When the created waveform is loaded, the graphical interface displays information on clock rate, number of samples and creation day. You can also acquire information about the waveform in the dedicated "Waveform Info" dialog.

### 5.10.2.2 ARB sequencer mode

If your setup requires a high switch-over speed, you can continuously scroll through the test signals with an external trigger or apply a predefined "Play List".

The R&S SMW200A provides settings to define a sequence of different segments. Also you can set the number of repetitions for playing the segment and adjust the transition between the segments.

Correct and fast processing and seamless transition between multiple waveforms requires segments with a common sample rate. If the combined waveforms feature different sample rates, set a common sample rate by resampling. Another advantage of

this procedure is the scaling of the instantaneous amplitude of the various waveforms to a common RMS level.

### 5.10.2.3 File concept

To provide flexible configuration, the building of a composed multi-segment waveform file involves different stages; by completing of each of them, the R&S SMW200A creates and saves a dedicated file. The following files are used:

- The "Configuration List" is a dedicated file with details on how a multi-segment waveform is made up from different waveforms, the level and the clock rate settings, and the filename. The file extension is `*.inf_mswv`.  
You can create any number of configurations as a basis for defining further multi-segment waveforms.
- The "Output File" is the multi-segment waveform file. You can enter a filename, the file extension is `*.wv`. The instrument appends additional information to the header of the composed waveform file, for example user comments.
- The "Sequencing List" contains files created in the "Multi Segment Waveform Sequencing" dialog, when using the ARB sequencer mode. See [Section 5.10.2.2, "ARB sequencer mode"](#), on page 361.  
The sequencing list file has an extension `*.wvs` and is automatically assigned to but independent from the multi-segment file. By default, both files have the same name and are located in the same file directory. You can create more than one sequencing list file per multi-segment waveform file.  
The sequencing list file carries information only about the segment number, the corresponding waveform filenames are retrieved from the assigned multi-segment waveform file. That is, the same sequencing list file can be reused for different multi-segment waveform files with the same number of segments.  
Changes and recalculations of a multi-segment waveform file cause a recheck of whether the assigned sequencing list files are still valid. A message is displayed to inform about necessary corrections in the "play list".

### 5.10.2.4 Impact of the marker settings

The general purpose of the marker signal is the triggering of the DUT (device under test) and the synchronization with other measurement instruments.

For better flexibility, the instrument provides several possibilities to define marker signals:

- Segment markers  
Because the multiple segments are standalone waveforms, they can already carry marker signals. You can define how the instrument processes these available marker signals. The instrument can ignore them or use them in the composed multi-segment waveform.
- Additional segment restart and sequence restart markers  
Additional marker signal can be defined to restart the multi-segment sequence or to restart each of the multiple segments. A marker output configured and defined for one of these purposes overwrites markers that use the same output connector and that are defined in the individual waveforms.

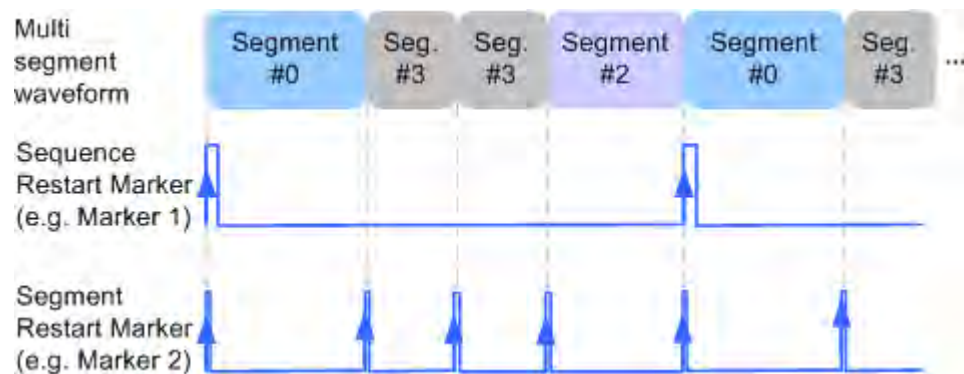

Figure 5-30: Example of marker signals

The segment start is defined by the low-high slope of the marker, which applies for switching between two segments and if there is a segment replay.

- General marker signals for the composed multi-segment waveform  
The "ARB" dialog also provides access to the standard marker settings. Settings other than "unchanged" overwrite existing markers in the waveforms or markers defined for the multi-segment waveform.

The [Figure 5-31](#) shows schematically how the instrument evaluates the priorities of the different marker signals, if multiple marker signals are mapped to the same connector.

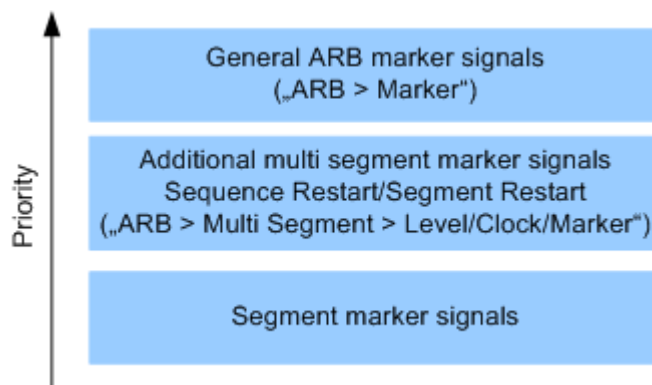

Figure 5-31: Marker priority and assigning of marker signals

#### 5.10.2.5 Impact of the trigger settings and next segment settings

The ARB dialog provides the standard (regular) trigger settings. Use these settings to trigger of the composed multi-segment waveform as a sequence in one file. For background information, see also [Section 5.5.1.5, "About trigger signals"](#), on page 235.

This section focuses on the additional settings provided for triggering of the individual segments building the composed multi-segment waveform. These settings are enabled and visible only if a multi-segment waveform is loaded for processing. The settings are grouped in the "Multi Segment Waveform Options/Next Segment Trigger In" section.

The [Figure 5-32](#) illustrates how trigger events affect the processing of the multi-segment waveforms.

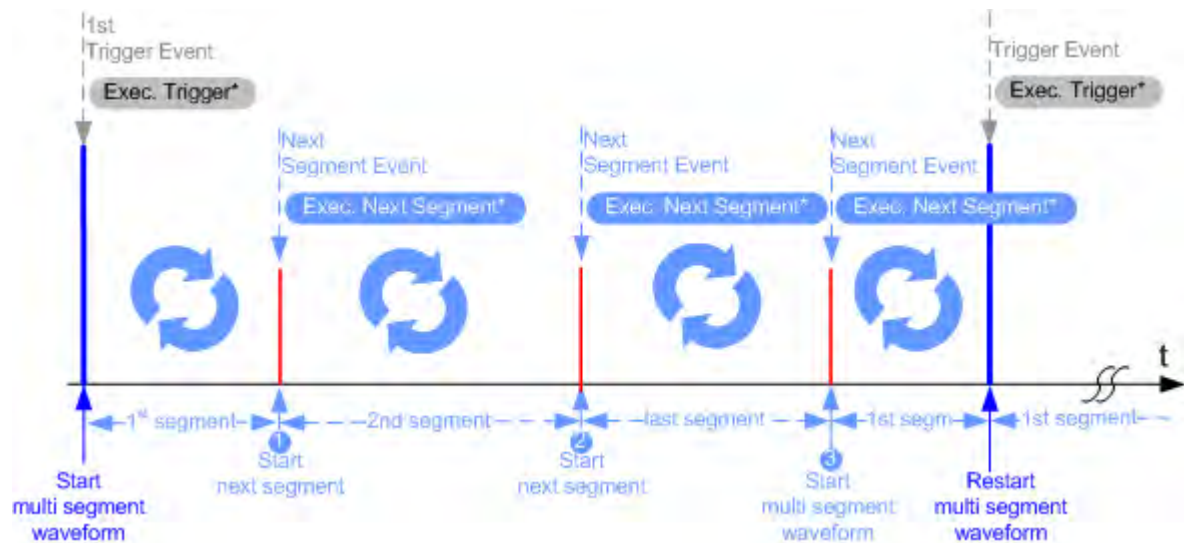

Figure 5-32: Principle of segment triggering

- \* = To simplify the description, an internal next segment trigger event ("Exec. Next Segment") and an internal trigger event ("Execute Trigger") are used; an external trigger event has the same effect on the signal generation.
- 1, 2 = Any next segment trigger event (internal or external) causes a switch over to the subsequent available segment in the waveform. The current output segment (segment filename and segment index) is indicated at "Current Segment".
- 3 = When the last segment of the multi-segment waveform is output, the sequence starts again with the output of the first segment after the next trigger event. Use a sequence of external next segment trigger events to output the segments in the multi-segment file cyclically.

### Defining the next segment source

As with the standard trigger system, provided are the following two sources for the next segment signal:

- **Internal:** the switch over to the subsequent segment is triggered manually with the "Execute Next Segment" function.  
To trigger a switch over to any segment within the multi-segment waveform, change the value of the parameter "Segment".
- **External:** the instrument expects a trigger event ("Global Next Segment") on one of the two provided and configured USER connectors.

### Defining subsequent segments

By default, the instrument replays the segments in incremental order, for example "Segment#1". If you want to change the order is required, use one of the following possibilities:

- "Next Segment": defines the subsequent segment while triggering the segments manually, i.e. by "Next Segment Source" > "Internal"
- "Sequencing List": the subsequent segment is defined in the selected play list.

### Defining the transition between the segments

The R&S SMW200A provides the parameter "Next Segment Mode" to define the transition to the next segment, see the table [Table 5-20](#).

- "Next Segment": by receiving a next segment event, the ARB aborts immediately the playing of the current waveform and starts playing the next segment waveform, see [Table 5-20](#).
- "Next Segment Seamless": by receiving a next segment event, the ARB completes the processing of the current waveform before starting the next segment waveform, see [Table 5-20](#).

Use this setting to avoid signal gaps and wrap-around problems. Seamless transition requires segments with equal clock rates.

Another way to generate a multi-segment signal without signal gaps between the segments is to use the provided ARB sequencer mode, see [Section 5.10.3.4](#), "Multi-segment waveform sequencing", on page 375.

The table [Table 5-20](#) shows two examples of the transition from a sine-wave signal segment to a sawtooth segment (1 channel, upper curve). The triggering mode is the next segment external triggering. The left graphic displays an abrupt transition. The right graphic displays the seamless transition case.

**Table 5-20: Transition examples**

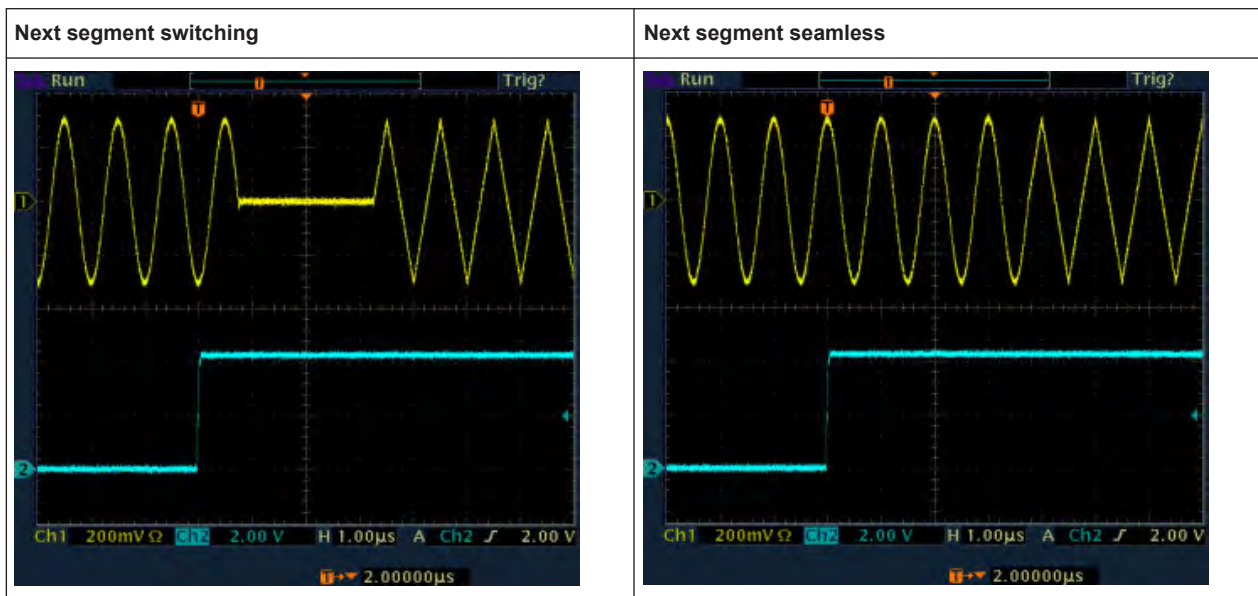

### Understanding the trigger examples



A simplified diagram in the ARB dialog is intended to explain the effect of the triggering on the signal processing. The currently enabled settings for trigger and next segment mode are considered.



The curves plotted in the dialog are textbook examples, "not measured" waveforms. They are intended to visualize the trigger and the next segment settings more clearly.

- The triangle on the top line denotes a trigger event. A filled triangle on the bottom line denotes a next segment event.
- A green sine wave (or other shape) over a full period indicates one replay cycle of a segment. A shorter example signal indicates a replay cycle which was interrupted, e.g. due to a next segment event (compare the two graphics in [Table 5-21](#)).

**Table 5-21: Trigger examples in the ARB dialog**

"Next Segment Mode = Next Segment"	"Next Segment Mode = Next Segment Seamless"
	

### 5.10.3 Multi-segment settings

Access:

1. Select "Baseband" > "ARB" > "General" > "Create Multi Segment".

The "ARB: Multi Segment" dialog enables direct assignment of waveforms to the multiple segments, adjusting the clock, level, and marker settings of the composed waveform and selecting the output file.

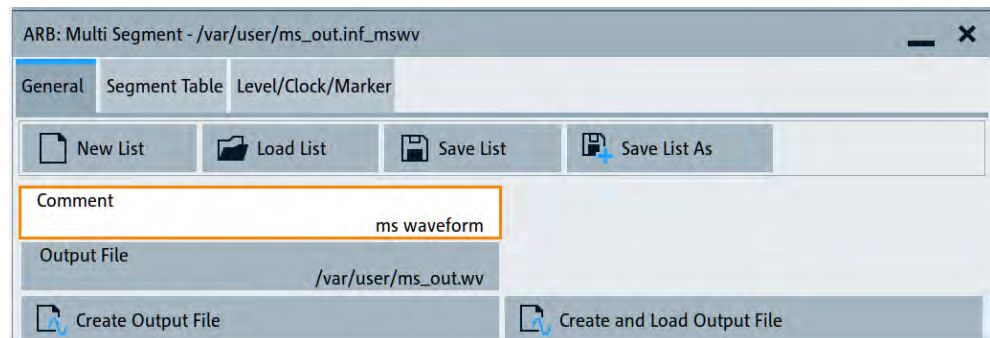

For description on the provided settings, refer to:

[Section 5.10.3.1, "General settings"](#), on page 367,

[Section 5.10.3.2, "Segment table"](#), on page 369 and

[Section 5.10.3.3, "Level/Clock/Marker settings"](#), on page 372

2. Select "ARB: Multi Segment" > "General" > "Create and Load Output File" to save and load the current multi-segment file.
3. Select "Multi Segment" > **"Sequencing List"** to access the settings for configuring a sequencing "Play List" for fast automatic processing of the multi-segment waveform.  
For a description of the provided settings, refer to [Section 5.10.3.4, "Multi-segment waveform sequencing"](#), on page 375.
4. Select "Baseband" > "ARB" > "General".

The "Load Waveform" confirms that the current multi-segment file is loaded (filename as defined with "Output File").

**Note:** The provided settings depend on the current waveform.

The "Sequencing List" function requires the following:

- Created multi-segment file via "Create Output File" or "Create and Load Output File".
- The "Sequence Table" contains more than one segment.

5. Select "Baseband" > "ARB" > "Trigger In (MSW)".

For related settings, see [Section 5.10.3.5, "Multi-segment waveform trigger settings"](#), on page 379.

6. Select "Baseband" > "ARB" > "General" > "State" > "On" to generate the multi-segment waveform.

The remote commands required to define these settings are described in [Section 14.19.5.3, "SOURCE:BB:ARbitrary subsystem"](#), on page 1092.

• <a href="#">General settings</a> .....	367
• <a href="#">Segment table</a> .....	369
• <a href="#">Level/Clock/Marker settings</a> .....	372
• <a href="#">Multi-segment waveform sequencing</a> .....	375
• <a href="#">Multi-segment waveform trigger settings</a> .....	379

### 5.10.3.1 General settings

Access:

1. Select "Baseband" > "ARB" > "General" > "Create Multi Segment".

The "General" tab provides standard functions for file handling, like selecting and loading of files, or determining the output filename.

2. Perform one of the following:

- Select "New List" to create a multi-segment waveform file
- Select "Load List" to load an existing one

3. Add a comment.

4. Select "Output File" to set the filename of the multi-segment waveform.

**Note:** The provided settings depend on the current waveform.

The "Sequencing List" function requires the following:

- Created multi-segment file via "Create Output File" or "Create and Load Output File".
- The "Sequence Table" contains more than one segment.

Settings:

<a href="#">New List</a> .....	368
<a href="#">Load List</a> .....	368
<a href="#">Save List/Save List As</a> .....	368

Sequencing List.....	368
Comment.....	368
Output File.....	368
Create Output File/Create and Load Output File.....	369

**New List**

Opens the standard "Create Multi Segment Waveform List" function to enter the name of the new file.

Remote command:

`[ :SOURce<hw> ] :BB:ARbitrary:WSEGment:CONFigure:SElect` on page 1120

**Load List**

Opens the standard "File Select" function to select the configuration file to be edited.

Remote command:

`[ :SOURce<hw> ] :BB:ARbitrary:WSEGment:CONFigure:CATalog?` on page 1117

`[ :SOURce<hw> ] :BB:ARbitrary:WSEGment:CONFigure:SElect` on page 1120

`[ :SOURce<hw> ] :BB:ARbitrary:WSEGment:CONFigure:DElete` on page 1118

**Save List/Save List As...**

Saves the current entries of the [Segment table](#) in a configuration list (file), including the level mode, clock mode, segment marker mode, and output filename settings.

See also [Section 5.10.2.3, "File concept"](#), on page 362.

Consider also the following remote control commands:

- To define the configuration file (`*.inf_mswv`) used by the calculation of the output file:
  - `[ :SOURce<hw> ] :BB:ARbitrary:WSEGment:CREate`
  - `[ :SOURce<hw> ] :BB:ARbitrary:WSEGment:CLOad`
- To define the filename of the output waveform file (`*.wv`):
  - `[ :SOURce<hw> ] :BB:ARbitrary:WSEGment:CONFigure:OFILe`

Remote command:

n.a.

**Sequencing List**

Requires a loaded multi-segment file.

Opens the dedicated dialog for configuring the associated play lists, see [Section 5.10.3.4, "Multi-segment waveform sequencing"](#), on page 375.

Remote command:

n.a.

**Comment**

Adds a comment to the composed multi-segment file.

Remote command:

`[ :SOURce<hw> ] :BB:ARbitrary:WSEGment:CONFigure:COMMENT` on page 1118

**Output File**

Opens the standard "File Select" dialog function and requests the filename for the multi-segment waveform to be calculated.



An output filename is required for further processing of the multi-segment waveform:

- For the internal storage triggered by the "Save List" function
- For the calculation and creation of the multi-segment waveform, triggered by the "Create" or "Create and Load" function.

Remote command:

`[ :SOURCE<hw> ] :BB:ARbitrary:WSEgment:CONFigure:OFILe` on page 1118

### Create Output File/Create and Load Output File

Creates a multi-segment waveform as follows:

"Create Output File" Creates a multi-segment waveform using the current entries in the segment table, see [Section 5.10.3.2, "Segment table"](#), on page 369.

"Create and Load Output File" Creates a multi-segment waveform and loads it in the ARB.

The R&S SMW200A saves the multicarrier waveform as a file with filename, see ["Output File"](#) on page 368.

Depending on the configuration of the multicarrier waveform, calculation takes some time. Use the "Abort" function to interrupt the calculation.

Remote command:

To define the configuration file (\*.inf\_mswv) used by the calculation of the output file:

`[ :SOURCE<hw> ] :BB:ARbitrary:WSEgment:CREate`

Or `[ :SOURCE<hw> ] :BB:ARbitrary:WSEgment:CLoad`

To define the filename of the output waveform file (\*.wv):

`[ :SOURCE<hw> ] :BB:ARbitrary:WSEgment:CONFigure:OFILe`

### 5.10.3.2 Segment table

Access:

1. Select "Baseband" > "ARB" > "General" > "Create Multi Segment ...".
2. In the "Multi Segment" > "General" dialog, select an existing list.
3. Select "Multi Segment" > "Segment Table".
4. Select "Append" to add waveform segments.
5. Select "Append Blank" to add a blank segment

## 6. Configure the "Blank Segment Settings" as required.

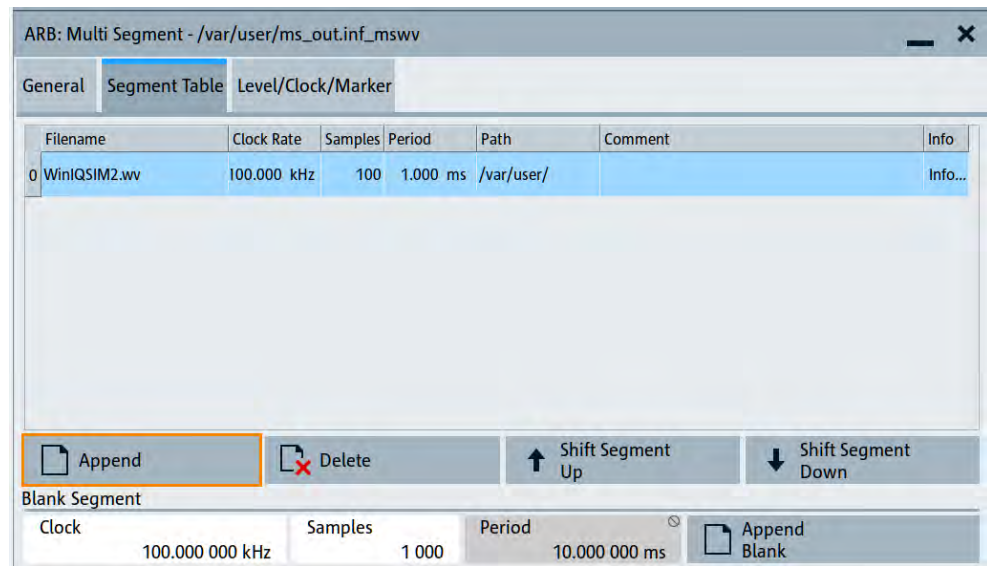

This section provides settings to create and adjust the contents of the multi-segment file.

**Settings:**

Segment Table.....	370
Append.....	371
Delete.....	371
Shift Segment Up.....	371
Shift Segment Down.....	371
Blank Segment.....	371
Clock Rate.....	372
Samples.....	372
Period.....	372
Append Blank.....	372

**Segment Table**

The table lists the individual waveforms (segments) of the selected multi-segment waveform. The information about the segments is retrieved from the tags of the corresponding waveform files.

"Segment#"	Indication of segment index. Within the manual and remote control configuration, this segment index indicates the segment explicitly. <b>Tip:</b> Use the segment index, for example, to define the subsequent sequence to be output in next segment Mode "Next Segment" or "Next Segment Seamless".
"Waveform"	Indication of the waveform filename of the segment.
"Clock Rate"	Indication of the clock rate of the selected waveform.
"Samples"	Indication of the number of samples in the segment.

"Period"	Indication of the segment duration.
"Path"	Indication of the location of the waveform file used for the corresponding segment.
"Comment"	Indication of the possible comments contained in the waveform.
"Info"	Indication of the possible comments contained in the waveform.

Remote command:

[\[:SOURCE<hw>\]:BB:ARbitrary:WSEgment:CONFigure:SEGment:CATalog?](#)  
on page 1113

### Append

Opens the standard "File Select" dialog for navigation to and selection of the waveform file to be added on the end of the existing list.

Only non-multi-segment waveforms can be loaded.

Remote command:

[\[:SOURCE<hw>\]:BB:ARbitrary:WSEgment:CONFigure:SEGment:APPend](#)  
on page 1119

### Delete

Removes the selected entry from the table. The waveform file itself is however not deleted.

Remote command:

[\[:SOURCE<hw>\]:BB:ARbitrary:WSEgment:CONFigure:SEGment:INDEX<ch0>:DElete](#) on page 1119

### Shift Segment Up

Moves up the selected segment by one row in the segment table.

Remote command:

[\[:SOURCE<hw>\]:BB:ARbitrary:WSEgment:CONFigure:SEGment:INDEX<ch0>:UP](#) on page 1119

### Shift Segment Down

Moves down the selected segment by one row in the segment table.

Remote command:

[\[:SOURCE<hw>\]:BB:ARbitrary:WSEgment:CONFigure:SEGment:INDEX<ch0>:DOWN](#) on page 1119

### Blank Segment

This section provides the settings to configure a blank segment. A blank segment is a zero signal with a defined clock rate and number of samples. For blank segments configure the following settings:

- ["Clock Rate"](#) on page 372
- ["Samples"](#) on page 372

- "Period" on page 372
- "Append Blank" on page 372

**Clock Rate**

Sets the clock rate of the blank segment.

Remote command:

```
[ :SOURce<hw> ] :BB:ARbitrary:WSEgment:CONFigure:BLANk:APPend  
on page 1116
```

**Samples**

Sets the number of samples for the blank segment.

Remote command:

```
[ :SOURce<hw> ] :BB:ARbitrary:WSEgment:CONFigure:BLANk:APPend  
on page 1116
```

**Period**

Displays the resulting period for the blank segment.

Remote command:

```
[ :SOURce<hw> ] :BB:ARbitrary:WSEgment:CONFigure:BLANk:APPend  
on page 1116
```

**Append Blank**

Adds the blank segment to the segment table.

Remote command:

```
[ :SOURce<hw> ] :BB:ARbitrary:WSEgment:CONFigure:BLANk:APPend  
on page 1116
```

### 5.10.3.3 Level/Clock/Marker settings

Access:

1. Select "Baseband" > "ARB" > "General" > "Create Multi Segment".
2. In the dialog "ARB: Multi Segment" > "General", select an existing list.
3. Select "ARB: Multi Segment" > "Segment Table" to configure the segments.
4. Select "ARB: Multi Segment" > "Level/Clock/Marker".

The "Level/Clock/Marker" tab provides settings to configure the level, marker and clock settings of the multi-segment waveform file.

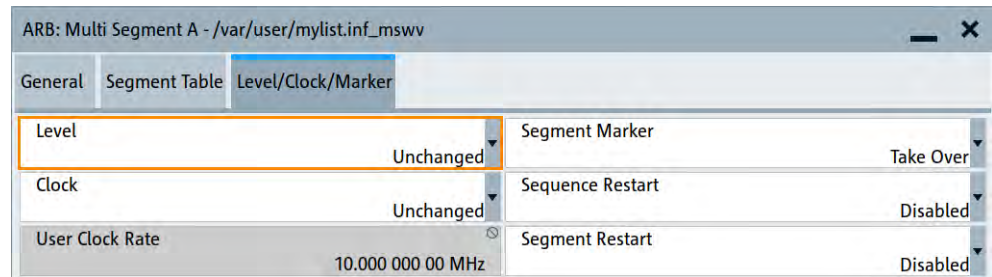
**Settings:**

Level.....	373
Clock.....	373
User Clock Rate.....	374
Segment Marker.....	374
Sequence Restart.....	374
Segment Restart.....	374

**Level**

Defines the way that the instrument determines the output level of each of the multiple waveforms.

- "Unchanged" Concerning the level settings, the segments are output exactly as defined in the individual files. The "Level" display applies only to the segment with the highest RMS value. Sometimes, the remaining segments are output at a lower level than the displayed value.
- "Equal RMS" The output segments have the same RMS value. The displayed "Level" applies to all segments.

Remote command:

```
[ :SOURce<hw> ] :BB:ARbitrary:WSEgment:CONFigure:LEVel [ :MODE ]
```

on page 1118

**Clock**

Defines the clock mode to set the clock rate of each of the multiple waveforms.

- "Unchanged" Each segment has the clock rate as in its waveform file.  
**Note:** For "Next Segment Mode" > "Next Segment Seamless", the segments require equal clock rates.
- "Highest" All segments have the highest available clock rate.  
**Note:** Trade-off between fast switch over and computing time. This mode provides short switch-over times between segments. But the computing time increases because the individual segments are resampled.
- "User" All segments are output at the clock rate, the "User Clock Rate". Also, this mode is a trade-off between fast switch over and computing time.

Remote command:

```
[ :SOURce<hw> ] :BB:ARbitrary:WSEgment:CONFigure:CLOCK:MODE
```

on page 1117

**User Clock Rate**

Display or sets the sample rate for multi-segment waveform output. Setting requires "Clock" > "User".

Remote command:

`[ :SOURce<hw> ] :BB:ARbitrary:WSEgment:CONFigure:CLOCK` on page 1117

**Segment Marker**

Defines the way the marker information within the separate segments is processed, see also [Section 5.10.2.4, "Impact of the marker settings"](#), on page 362.

"Ignore"            The marker information carried in the individual segment waveform files is not considered.

"Take Over"        The output waveform file contains the marker information as configured in the individual waveform files.

Remote command:

`[ :SOURce<hw> ] :BB:ARbitrary:WSEgment:CONFigure:MARKer:MODE`  
on page 1115

**Sequence Restart**

Enables/disables the generation of an extra restart marker in the output waveform file.

If additional marker generation is enabled, the existing marker signals in the individual segment waveform files are not considered, see also [Section 5.10.2.4, "Impact of the marker settings"](#), on page 362.

"Disabled"         No additional marker is generated.

"Marker 1"/"Marker 2"/"Marker 3"  
                      Generates a restart marker signal at the beginning of the first segment of the complete multi-segment sequence.

Remote command:

`[ :SOURce<hw> ] :BB:ARbitrary:WSEgment:CONFigure:MARKer:FSEgment`  
on page 1115

**Segment Restart**

Enables/disables the generation of an extra restart marker in the output waveform file.

If additional marker generation is enabled, the existing marker signals in the individual segment waveform files are not considered, see also [Section 5.10.2.4, "Impact of the marker settings"](#), on page 362.

"Disabled"         No additional marker is generated.

"Marker 1"/"Marker 2"/"Marker 3"  
                      Generates a restart marker signal at the beginning of each segment. The segment start is defined by the low-high slope of the marker signal, which applies for switching between two segments and if there is a segment replay.

Remote command:

`[ :SOURce<hw> ] :BB:ARbitrary:WSEgment:CONFigure:MARKer:ESEgment`  
on page 1115

### 5.10.3.4 Multi-segment waveform sequencing

Access:

1. Select "Baseband" > "ARB" > "General" > "Create Multi Segment".
2. In the "ARB: Multi Segment" > "General" dialog, select an existing list.
3. Select "ARB: Multi Segment" > "Segment Table".
4. Configure a waveform with more than one segment.
5. Select "ARB: Multi Segment" > "Level/Clock/Marker"
6. Adjust the clock settings so that all segments use the same clock rate.
7. Select "ARB: Multi Segment" > "General"  
> **"Create Output File/Create and Load Output File"**.
8. Select "Sequencing List...".
9. Select "New" or "Load" to load a sequencing list file.

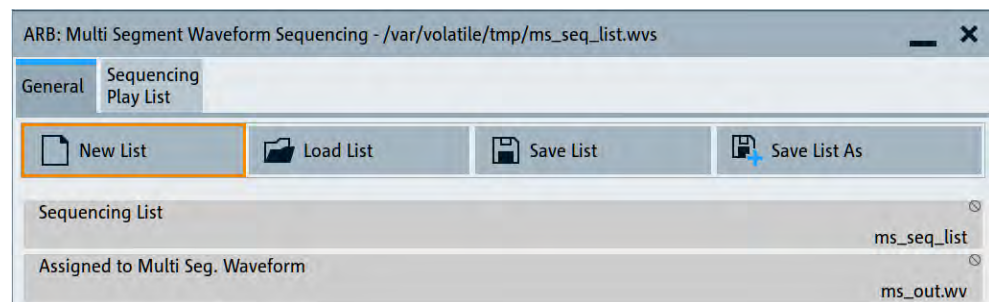

10. Select "ARB: Multi Segment Waveform Sequencing" > "Sequencing Play List" to create a "Play List".  
A new sequencing list contains no information.
11. Use the "Append"/"Delete" and "Up"/"Down" functions to configure the order of processing the segments.  
The user interface shows the configured play list in the form of a "Sequencing Graphic".

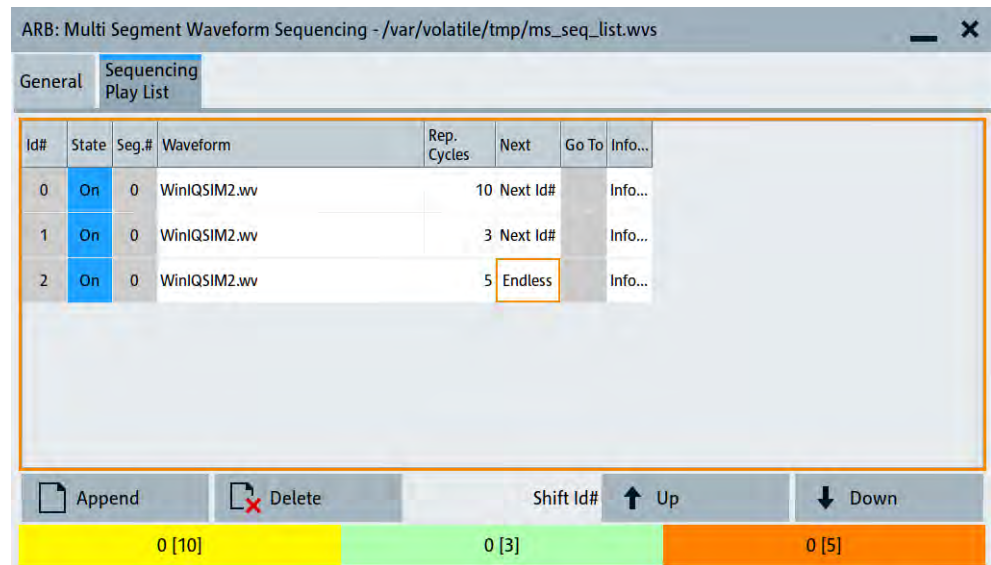

For related settings, see "Sequencing play list settings" on page 377.

12. Select "ARB: Multi Segment Waveform Sequencing" > "General" > "Save" to save the "Play List".
13. Select "ARB: Multi Segment" > "General" > "Create and Load Output File".
14. To use the "Play List", select "ARB" > "Next Segment Waveform Options" > "Next Segment Mode" > "Sequencer".

**Settings:**

- [General settings](#).....376
- [Sequencing play list settings](#).....377

**General settings**

Access:

- ▶ Select "Baseband" > "ARB" > "General" > "Create Multi Segment" > "Sequencing List...".

**Settings:**

- [New Sequencing List/Load Sequencing List](#).....376
- [Save List/Save List As](#).....377
- [Sequencing List](#).....377
- [Assigned to Multi Seg. Waveform](#).....377

**New Sequencing List/Load Sequencing List**

Opens the standard "Select Sequencing List" function to define the name of the new play list file or select of an existing one.

Remote command:

[ :SOURce<hw> ] :BB:ARbitrary:WSEgment:SEquence:SElect on page 1113



**Save List/Save List As**

Saves the current entries of the table in a play list file. Play list files have the file extension \*.wvs.

The default filename of the play list file is the same as the multi-segment waveform filename, but it can be changed.

**Sequencing List**

Displays the name of the selected sequencing list file, i.e. the file with the "play list" settings (see [Section 5.10.2.3, "File concept"](#), on page 362).

Remote command:

n.a.

**Assigned to Multi Seg. Waveform**

Displays the name of the multi-segment waveform file within the current sequencing list file.

Remote command:

n.a.

**Sequencing play list settings**

Access:

- ▶ Select "Baseband" > "ARB" > "General" > "Create Multi Segment" > "Sequencing List..." > "Sequencing Play List".

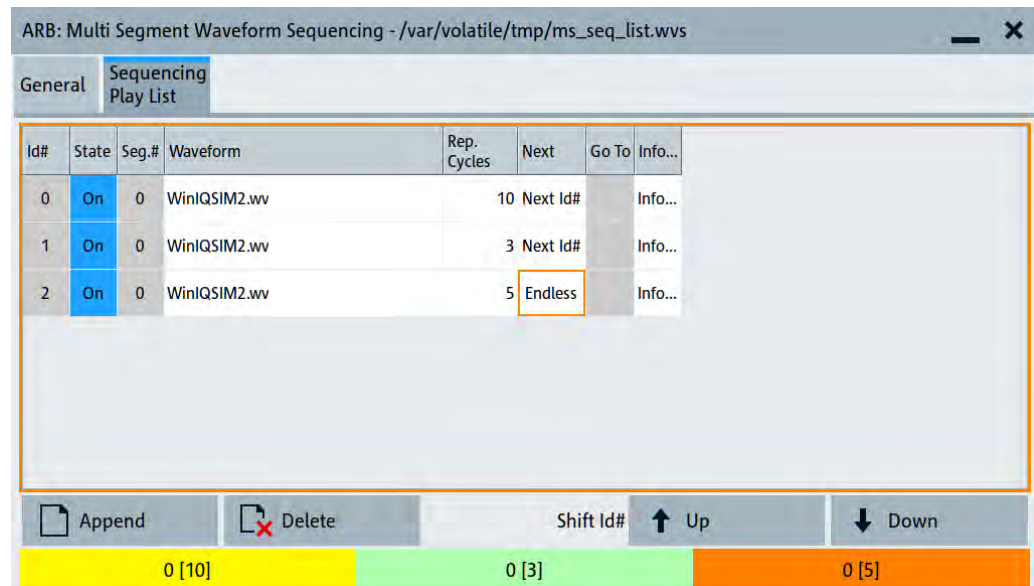
**Settings:**

Sequencing Play List.....	378
L Next.....	378
L Append.....	378

L Delete.....	379
L Shift Id# Up/Shift Id# Down.....	379
Sequencing Graphic.....	379

### Sequencing Play List

The "Sequencing Play List" table defines the sequence order for processing the waveform file segments. Also, you can set the repetition of individual segments.

"Id#"	Indicates the row number.
"State"	Enables/disables the selected row. Only active segments are processed.
"Segment#"	Indicates the segment index. The sequencing list file carries information only about the segment index. The assigned multi-segment waveform file provides the corresponding filenames.
"Waveform"	Indicates the waveform file mapped to the corresponding segment. The R&S SMW200A reads out this filename from the multi-segment waveform file. Available are only waveform files from the pool of segments of the selected multi-segment waveform file.
"Repetition Cycles"	Sets the number of times the selected segment is cyclically repeated before the next segment in the sequence is processed.
"Info"	Opens a dialog with detailed information about the currently selected waveform.

Remote command:

See "[Append](#)" on page 378.

### Next ← Sequencing Play List

Determines the action after completing the current segment. For example, determines which segment the R&S SMW200A is processes after the processing the current segment.

"Next Id#"	The next active segment in the play list is processed.
"Blank"	After the processing of the current segment is completed, the signal output is stopped until a signal restart like a retrigger signal is received. A restart signal causes a complete restart of the sequencing play list.
"Endless"	The current segment is replayed until a signal restart like a retrigger signal is received and the complete sequencing play list is restarted. Only active segments are considered.
"Goto Id#"	Determines the row number of the segment to be processed next. This feature is limited to the first 32 rows.

### Append ← Sequencing Play List

Inserts a new row at the end of the sequencing play list table.

Remote command:

[ :SOURce<hw> ] :BB:ARbitrary:WSEgment:SEquence:SElect on page 1113

[ :SOURce<hw> ] :BB:ARbitrary:WSEgment:SEquence:APPend on page 1114

#### Delete ← Sequencing Play List

Deletes the selected row.

#### Shift Id# Up/Shift Id# Down ← Sequencing Play List

Rearranges the rows that means moves the selected row up and down.

#### Sequencing Graphic

Displays the play list graph according to the current configuration.

The graph shows the segment sequence, the segment number, and the number of times the segment is repeated; considered are only the active segments.

### 5.10.3.5 Multi-segment waveform trigger settings

The settings in the "Trigger In (MSW)" tab are visible only if a multi-segment waveform is loaded into the ARB.

Access:

1. Load a multi-segment waveform in the ARB.  
See [Section 5.10.3, "Multi-segment settings"](#), on page 366.
2. Select "Baseband" > "ARB" > "Trigger In (MSW)".

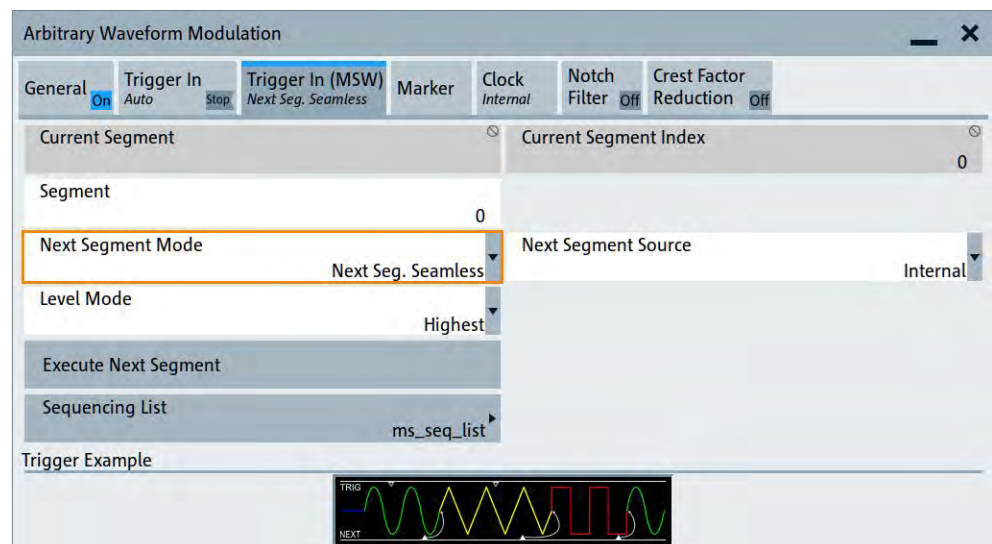

The tab provides settings to configure the trigger for switching between the segments of a multi-segment waveform. The parameters depend on the selected trigger source.

**Settings:**

Current Segment/Current Segment Index.....	380
Segment.....	380
Next Segment Mode.....	380
Next Segment Source.....	381
Level Mode.....	381
Execute Next Segment.....	382
Sequencing List.....	382
Trigger Example.....	382

**Current Segment/Current Segment Index**

Indicates the waveform segment (segment filename and index) that is output.

Remote command:

`[ :SOURce<hw> ] :BB:ARbitrary:WSEgment?` on page 1112

`[ :SOURce<hw> ] :BB:ARbitrary:WSEgment:NAME?` on page 1112

**Segment**

Selects the waveform segment to be output after the segment indicated as "Current Segment". This parameter determines the start segment when switching on the ARB and enables switching over to any other segment.

The following events cause a switch over:

- A trigger event of an external next segment
- An internal segment trigger that is a change in the segment index in the "Segment" field

Use the parameter [Next Segment Mode](#) to define whether the new segment is generated immediately or only after the previous segment has been fully generated (wrap around). The subsequent trigger event after the last segment causes the first segment to be output again.

For more information, see [Section 5.10.2.5, "Impact of the trigger settings and next segment settings"](#), on page 363.

Remote command:

`[ :SOURce<hw> ] :BB:ARbitrary:WSEgment:NEXT` on page 1112

**Next Segment Mode**

Defines the way the **switch over between the segments** in a multi-segment waveform is executed.

The regular trigger mode for starting the waveform generation and **triggering the whole multi-segment sequence** is set with the parameters in the "ARB > Trigger" tab. The segment currently being output is displayed at "Current Segment". The "Trigger Example" graph displays schematically the waveform output, depending on the activated trigger and the next segment settings.

For background information, refer to [Section 5.10.2.5, "Impact of the trigger settings and next segment settings"](#), on page 363.

For detailed information on how the regular trigger signal affects the multi-segment waveform processing in combination with the different values for "Next Segment Mode", refer to [Section 5.10.5, "Reference to triggering of multi-segment waveforms"](#), on page 388.

**Note:** The seamless switch over and the sequencer mode require segments with equal sample rate.

"Same Segment"

The processing of the multi-segment waveform file is similar to the processing of a non-multi-segment waveform. There is no switching to consecutive segments upon the receiving of a trigger event. To trigger switching between the segments, change the segment index in the "Segment" field.

"Next Segment"

The current segment ceases to be output when a trigger event for a new segment occurs, and the new segment starts to be output after a system-imposed signal gap.

"Next Segment Seamless"

If all segments have the same sample rate, the new segment is not output until all segments are output (wrap around), i.e. the signal transition is seamless.

"Sequencer"

The waveform files are processed according to the order and repetition cycles defined in the special sequencing list file (\*.wvs) assigned to the multi-segment waveform file. This "play list" is defined in the [Multi-segment waveform sequencing](#) dialog.

Remote command:

[\[:SOURCE<hw>\]:BB:ARbitrary:TRIGger:SMODE](#) on page 1116

### Next Segment Source

Selects whether the next segment is switched upon receiving of an external trigger signal or upon executing of software next segment trigger (see [Figure 5-32](#)).

This parameter is disabled if a sequencing play list is used.

"Internal"

Switch over to any segment is triggered manually with the "Execute Next Segment" function.

"External Global Next Segment"

The trigger event for switching to the next segment is input as configured on one of the USER x connectors.

See also [Section 12.2, "Configuring local and global connectors"](#), on page 742.

Remote command:

[\[:SOURCE<hw>\]:BB:ARbitrary:WSEgment:NEXT:SOURce](#) on page 1113

### Level Mode

Sets how the instrument levels the individual segments in a multi-segment signal. The parameter is important if waveforms with different crest factors are used.

"Highest"

All segments are output at the highest available crest factor.

"Unchanged"

Each segment is output with the crest factor defined in its waveform file.

Remote command:

[\[:SOURCE<hw>\]:BB:ARbitrary:WSEgment:LMODE](#) on page 1113

**Execute Next Segment**

For "Next Segment Source = Internal", triggers manually switch over to the subsequent segment in the multi-segment file. The subsequent segment can be any segment within the multi-segment file and is defined by the parameter "Segment".

This parameter is disabled if a sequencing play list is enabled.

Remote command:

`[ :SOURce<hw> ] :BB:ARbitrary:WSEgment:NEXT:EXECute` on page 1112

**Sequencing List**

Opens a dialog box for defining the "play lists", see [Section 5.10.3.4, "Multi-segment waveform sequencing"](#), on page 375.

Remote command:

`[ :SOURce<hw> ] :BB:ARbitrary:WSEgment:SEquence:SElect` on page 1113

**Trigger Example**

Displays an example of a multi-segment waveform. The currently enabled trigger and next segment mode are considered. After the instrument is switched on, the graph of the last loaded waveform is displayed.

**Note:** The curves plotted in this dialog box are textbook examples, "not measured" waveforms. They are intended to visualize the trigger and next segment settings more clearly.

Remote command:

n.a.

**5.10.4 Working with multi-segment waveform files**

This section provides step-by-step instructions on how to configure and use the multi-segment settings. The [Figure 5-33](#) shows the essential stages of multi-segment waveform configuration, together with the corresponding user interface dialogs and if applicable, the corresponding file extensions. Perform the necessary settings, enable the signal generation, and provide the trigger signal.

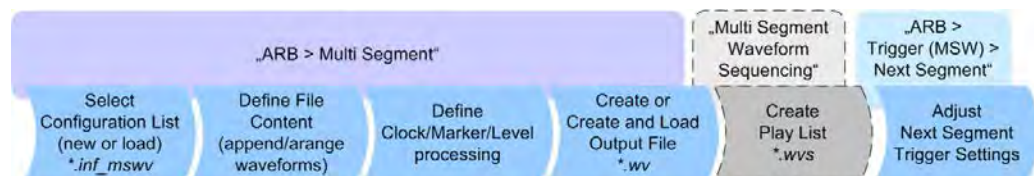

**Figure 5-33: Basic workflow for generation of multi-segment waveforms**

**To generate a multi-segment waveform file**

1. In the "ARB" > "General" > "Create Multi Segment" > "General" dialog, select "New List" to create an empty list.
2. Use the "ARB: Multi Segment" > "Segment Table" > "Append" function to add multiple waveform files.

3. In the "ARB: Multi Segment" > "Level/Clock/Marker" dialog, adjust the "Level", "Clock", and "Segment Marker" settings.
4. Select the "ARB" > "Create Multi Segment" > "General" > "Output File" to enter the filename.
5. Select "Save List" to save the configuration file.
6. Select "Create Output File" or "Create and Load Output File".
7. Select "State" > "On".



The following description emphasizes on the settings required to fulfill the particular task or achieve the desired performance; standard basic settings are not discussed. All provided examples use the example segment sequence as shown on [Figure 5-34](#).

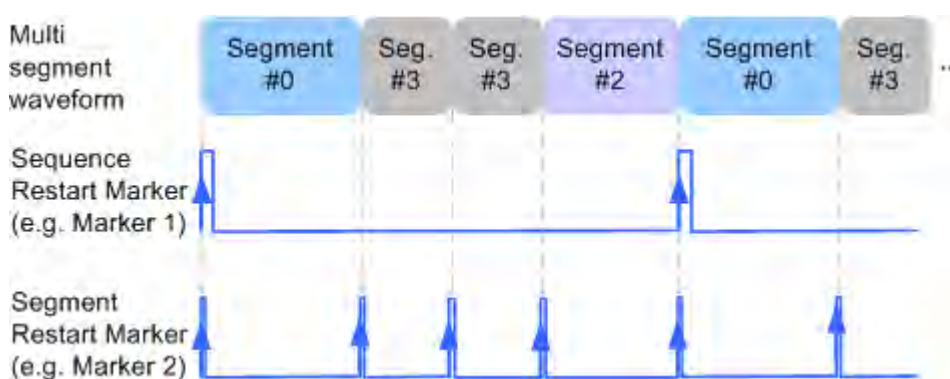

Figure 5-34: Example: multi-segment sequence with marker signals

See how to:

- ["To switch output segments manually"](#) on page 383
- ["To generate a multi-segment signal without signal interruptions"](#) on page 384
- ["To enable external triggering for high-speed switch over"](#) on page 385
- ["To use the play list function"](#) on page 386
- ["To add marker signals"](#) on page 387

### To switch output segments manually

When testing a DUT using different test signals, you want to switch dynamically and flexibly between any of the test signals. For example, switching due to the outcome of the previous test. The following settings enable flexible dynamic switch over between the segments in a multi-segment waveform.

We assume that a multi-segment sequence composed of 4 segments ("Seg#0", "Seg#1", "Seg#2" and "Seg#3") is created and loaded in the ARB. See ["To generate a multi-segment waveform file"](#) on page 382). The required output order of the segments is "Seg#0", "Seg#3", "Seg#2". The instrument is operated manually, the ARB is enabled, and the instrument output is on.

1. Select "ARB" > "Trigger In (MSW)" > "Next Segment Mode" > "Next Segment".

The transition between the segments is abrupt.

2. To enable manual next segment triggering, select "ARB" > "Trigger In (MSW)" > "Next Segment Source" > "Internal".
3. To enable manual triggering, proceed as follows:
  - a) Select "ARB" > "Trigger In" > "Mode" > "Armed Auto".
  - b) Select "Source" > "Internal".
  - c) Tap "Execute Trigger" to trigger the signal generation.

The "ARB" > "Trigger In (MSW)" settings display the current output segment: "Current Segment Name = Seg#0" and "Current Segment Index = 0". Outputs the "Seg#0" continuously.

4. Set "ARB" > "Trigger In (MSW)" > "Segment" > "3" to output the second segment in the sequence order.

The parameter "Current Segment Index" changes to segment index 3. "Seg#3" is output continuously.

5. In the "ARB" > "Trigger In" dialog, tap "Execute Trigger" to restart "Seg#3".
6. Set "ARB" > "Trigger In (MSW)" > "Segment" > "2" to output the third segment in the sequence order.

The sequencer outputs "Seg#2" continuously.

7. To switch over to "Seg#0", change the "ARB" > "Trigger In (MSW)" > "Current Segment Index", etc.

The ARB sequencer mode provides settings to achieve the same goal in a more convenient way, see ["To use the play list function"](#) on page 386.



#### **Faster flexible dynamic switch over**

When controlling remotely via an external computer, the following settings enable switching times of about 20 ms. These times apply for segments with the same sample rate and about 200 ms for segments with different sample rates:

- "ARB" > "Trigger In (MSW)" > "Next Segment Mode" > "Next Segment".
- "ARB" > "Trigger In" > "Mode" > "Auto"
- "ARB" > "Trigger In" > "Source" > "Internal"

#### **To generate a multi-segment signal without signal interruptions**

Testing receivers requires a continuous output of different test signals without interrupting the signal. The test signals then produce a complex total signal with no signal gaps on switch over. Control procedures can use a simulated back channel of the receiver (trigger line or remote control).



Switching times depend on the length of the segment currently being output, because the switch over to the next segment does not take place until the current segment ends.



To overcome wrap-around problems and generate multi-segment signals without signal gaps between the segments, consider the following settings:

1. Enable "ARB" > "Trigger In (MSW)" > "Next Segment Mode" > "Next Segment Seamless"
2. Select "ARB" > "Trigger In" > "Mode" > "Auto"
3. Select "ARB" > "Trigger In" > "Source" > "Internal"
4. Change the value of the parameter "ARB" > "Trigger In (MSW)" > "Segment" to select the segment index processed after completing the current one.

The R&S SMW200A outputs a segment ("Current Segment") continuously as long as you do not change the value of the parameter "Segment".

5. The seamless transition between the segments requires waveforms with equal clock rate.

If the waveforms feature different sample rates, select "ARB" > "Create Multi Segment" > "Level/Clock/Marker" > "Clock Mode" > "Highest" or "Clock Mode" > "User" to resample the waveforms.

#### To enable external triggering for high-speed switch over

Testing a DUT or a chip with different test signals at high throughput requires a fast switch over. For example, when testing ATE devices during manufacturing.

We assume that you created and loaded the required multi-segment sequence into the ARB, see ["To generate a multi-segment waveform file"](#) on page 382. The instrument outputs the segments in incremental order.

The instrument is in manual operation mode, the ARB is enabled and the instrument output is on. An external global or local trigger source is connected to the instrument and the corresponding connectors are configured.

The following settings enable switching times of about 5 us and the test signals are scrolled through with the aid of an external trigger signal:

1. Select "ARB" > "Trigger In (MSW)" > "Next Segment Mode" > "Next Segment".
2. Select "ARB" > "Trigger In (MSW)" > "Next Segment Source" > "External Global Next Segment 1".
3. Do not change the displayed segment index via "ARB" > "Trigger In (MSW)" > "Segment".
4. Select "ARB" > "Trigger In" > "Mode" > "Auto".
5. Select "Source" > "External Global Trigger"/"External Local Trigger".

6. If the waveforms in the multi-segment file feature different sample rates, select "ARB" > "Create Multi Segment" > "Level/Clock/Marker" > "Clock Mode" > "Highest" or "Clock Mode" > "Highest" to resample the waveforms.

The switch over between the segments is triggered by the receiving of an external trigger event. The segments are output in incremental order. As long as the instrument receives a new trigger event, it outputs the "Current Segment" continuously. A new trigger event aborts the output of the current segment immediately and starts the processing of the next one in the sequence.

**Tip:** To output the segments in any order, use the ARB sequencer mode, see "[To use the play list function](#)" on page 386.

See also [Section 12.2, "Configuring local and global connectors"](#), on page 742.

### To use the play list function



The ARB sequencer mode requires waveform files with equal clock rate.

We assume that you created and loaded a multi-segment sequence with four segments into the ARB, see "[To switch output segments manually](#)" on page 383. The required output order of the segments is "Seg#0", "Seg#3" (twice) and "Seg#2". The instrument is in manual operation mode, the ARB is enabled and the instrument output is on.

The following settings show an example of how to configure this segment output order with the help of the ARB sequencing function.

1. In the "ARB: Multi Segment" dialog, select "Create and Load".
2. Select "General" > "Sequencing List".

The "Multi Segment Waveform Sequencing" dialog opens. It displays the new play list and the current multi-segment waveform file.

3. Select "Sequencing Play List".
4. Configure the settings as follows:
  - a) "Id#" = "0": "Seg#" = "0", "Rep. Cycles" = "1", "Next" = "Next Id#"
  - b) "Id#" = "1": "Seg#" = "3", "Rep. Cycles" = "2", "Next" = "Next Id#"
  - c) "Id#" = "2": "Seg#" = "2", "Rep. Cycles" = "1", "Next" = "Goto Id", "Go To" = "0"

This setting creates a loop to the first segment in the sequence.

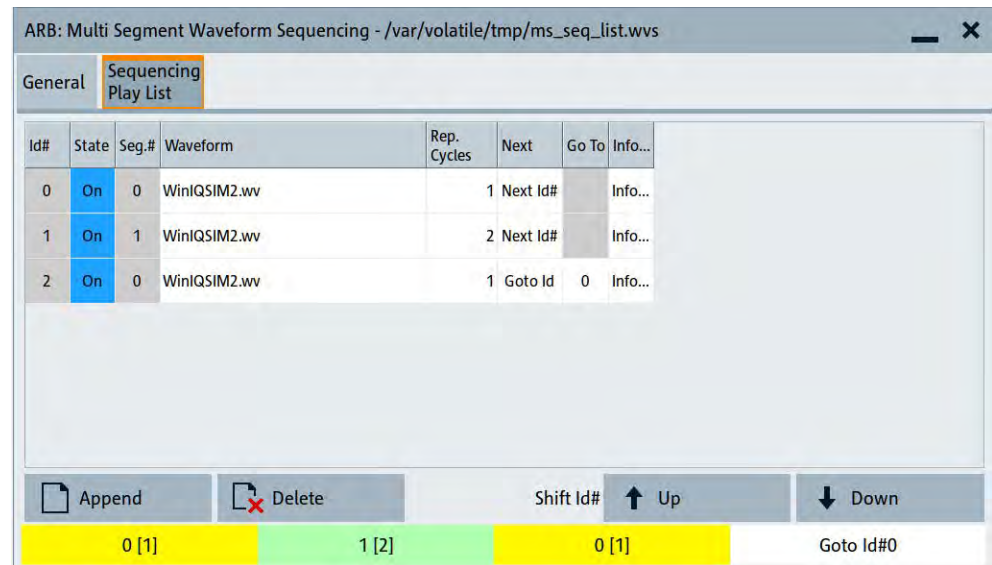

- To save the configuration, select "General" > "Save List".
- To use this play list, select "ARB" > "Trigger (MSW)" > "Next Segment Mode" > "Sequencer".
- Select the trigger mode "Mode" = "Armed Auto".
- Select the trigger source "Source" = "Internal".

The segments are played back (output) as defined in the sequencing list. The switch over to the next segment is performed automatically according to the rules and segment order defined in the "Sequencing Play List".

### To add marker signals

We assume that a multi-segment sequence composed of the segments Seg#0 [1], Seg#3 [2], Seg#2 [1] is created and loaded in the ARB (see ["To use the play list function"](#) on page 386). The multi-segment sequence starts with Seg#0 and this segment is output once. The instrument is operated manually, the ARB is enabled and the instrument output is switched on.

To add marker signals at the beginning of each segment and at the beginning of the sequence (see [Figure 5-34](#)), two additional marker signals, "Marker 2" and "Marker 1", are enabled and inserted into the multi-segment waveform.

- Select "ARB > Marker > Mode > Marker 1/Marker2 = Unchanged" to enable taking over of the marker signals defined inside the multi-segment sequence. If necessary, adjust the marker delay settings.
- Select the "Trigger/Marker/Clock" to map the "Logical Signals > Marker 1/Marker 2" to the desired connectors ("Global Connectors > User x > Direction = Output" and "Signal = Baseband Marker 1/Baseband Marker 2")
- In the "ARB > Multi Segment > Level/Clock/Marker" dialog, select "Segment Marker = Ignore"

4. Enable "Level/Clock/Marker > Sequence Restart = Marker 1"
5. Enable "Level/Clock/Marker > Segment Restart = Marker 2"

An extra restart marker signal is generated at the beginning of each segment and the beginning of the waveform. These restart markers *overwrite* the existing Marker 1 and Marker 2 trace signals defined in the waveforms of the individual segments.

### 5.10.5 Reference to triggering of multi-segment waveforms

Signal generation of multi-segment waveforms takes place differently according to the trigger selected in the "ARB > Trigger In" section. The sections provide a detailed explanation of the effect of a trigger event on the multi-segment waveform processing, depending on the enabled "Next Trigger Mode". Refer to [Section 5.10.2.5, "Impact of the trigger settings and next segment settings"](#), on page 363 for background information.

#### 5.10.5.1 Triggering in "Next trigger mode = same segment"

Depending on the trigger setting, the currently selected segment is continuously output either immediately or after a trigger event.

**Table 5-22: Waveform triggering: "Next Trigger Mode = Same Segment", "Trigger Source = Internal"**

"Trigger Mode"	Description
"Auto"	Output starts at once and the segment is generated continuously. Trigger events are ignored.  If the segment is changed in "Segment", output of the current segment is stopped and the new segment is output immediately, following a system-imposed signal gap.
"Armed_Auto"	Output starts after the first trigger event. The segment is then generated continuously. Further trigger events are ignored.  If the segment is changed in "Segment", signal output is stopped and the new segment is not output until a trigger occurs.
"Retrigger"	Output starts at once and the segment is generated continuously, a trigger event causes a restart.  If the segment is changed in "Segment", output of the current segment is stopped and the new segment is output immediately, following a system-imposed signal gap.
"Armed_Retrigger"	Output starts after the first trigger event. The segment is then generated continuously. Further trigger events cause a restart.  If the segment is changed in "Segment", signal output is stopped and the new segment is not output until a trigger occurs.
"Single"	Output starts after the first trigger event. The segment is then generated once. Further trigger events cause a restart.  If the segment is changed in "Segment", signal output is not stopped. The new segment is not output until a trigger occurs.

### 5.10.5.2 Triggering in "Next trigger mode = next segment"

Depending on the trigger setting, the segment selected under "Segment" is output either immediately or after a trigger event. If the segment index is changed in "Segment", the new segment is not output until a trigger occurs.

**Table 5-23: Waveform triggering: "Next Trigger Mode = Next Segment", "Trigger Source = Internal"**

"Trigger Mode"	Description
"Auto"	Output starts at once and the segment is generated continuously. If the segment index is changed in "Segment", output of the current segment is stopped and the new segment is output immediately, following a system-imposed signal gap.
"Armed_Auto"	Output starts after the first trigger event. The segment is then generated continuously. If the segment index is changed in "Segment", output of the current segment is stopped and the new segment is output immediately, following a system-imposed signal gap.
"Single"	Output starts after the first trigger event. The segment is then generated once. Further trigger events cause a restart. If the segment index is changed in "Segment", the new segment is not output until a trigger occurs.

**Table 5-24: Waveform triggering: "Next Trigger Mode = Next Segment", "Trigger Source = External"**

"Trigger Mode"	Description
"Auto"	Output starts at once and the segment is generated continuously. Further trigger events are ignored. Each next segment trigger event switches over to output the subsequent segment, following a system-imposed signal gap. If the segment index is changed in "Segment", output of the current segment is stopped and the new segment is output immediately, following a system-imposed signal gap. The subsequent trigger event after the last segment causes the first segment to be output again.
"Armed_Auto"	Output starts after the first trigger event. The segment is then generated continuously. Further trigger events are ignored. Each next segment trigger event switches over to output the subsequent segment, following a system-imposed signal gap. If the segment is changed in "Segment", signal output is stopped and the new segment is not output until a trigger occurs. The subsequent trigger event after the last segment causes the first segment to be output again.
"Single"	Output starts after the first trigger event. The segment is then generated once. Each trigger event (re-) starts the segment; each next segment trigger event switches to the output of the subsequent segment. If the segment is changed in "Segment", signal output is not stopped. The new segment is not output until a trigger occurs. The subsequent trigger event after the last segment causes the first segment to be output again.

For a description of the "Retrigger" and "Armed\_Retrigger" trigger modes, see [Table 5-22](#).

### 5.10.5.3 Triggering in "Next trigger mode = next segment seamless"

The segment selected under "Segment" is output. This mode is only available if all segments have the same sample rate.

**Table 5-25: Waveform triggering: "Next Trigger Mode = Next Segment Seamless", "Trigger Source = Internal"**

"Trigger Mode"	Description
"Auto"	Output starts at once and the segment is generated continuously. If the segment is changed in "Segment", the new segment is output seamlessly after the output of the current segment is complete.
"Armed_Auto"	Output starts after the first trigger event. The segment is then generated continuously. If the segment is changed in "Segment", signal output is stopped and the new segment is not output until a trigger occurs.
"Single"	Output starts at once and the segment is generated continuously. Each trigger event (re-) starts the segment; each next segment trigger event switches over to outputting the subsequent segment once the output of the current segment has been completed. If the segment is changed in "Segment", the new segment is output seamlessly after the output of the current segment is complete.

**Table 5-26: Waveform triggering: "Next Trigger Mode = Next Segment Seamless", "Trigger Source = External"**

"Trigger Mode"	Description
"Armed_Auto"	Output starts after the first trigger event. The segment is then generated continuously. Each trigger event (re-) starts the segment; each next segment trigger event switches over to outputting the subsequent segment once the output of the current segment has been completed. If the segment is changed in "Segment", signal output is stopped and the new segment is not output until a trigger occurs.

For a description of the "Retrigger" and "Armed\_Retrigger" trigger modes, see [Table 5-22](#).

### 5.10.5.4 Triggering in "Next trigger mode = sequencer"

The waveform files are processed according to the order and repetition cycles defined in the special sequencing list file (\*.wvs) assigned to the multi-segment waveform file.

## 5.11 Generating multicarrier waveform signals

To simulate complex multicarrier scenarios with different baseband signals, the R&S SMW200A provides the possibility to generate multicarrier waveforms. These waveforms can consist of up to 512 carriers, each modulated by the same or by different user-selectable baseband signal.

The multicarrier waveform is a practical solution for the generation of a complex broadband signal, for example:

- Multicarrier waveforms build from signals of different communication standards (e.g. CDMA2000 or 3GPP FDD)
- Multicarrier waveforms composed of several signals from the same communication standard as in LTE Advanced.

Generation of multi-segment waveform files is possible in configurations with separated baseband sources: "System Configuration" > "Fading/Baseband Config" > "BB Source Config" > "Separate Sources".

### 5.11.1 Required options

See [Section 5.7.1, "Required options"](#), on page 303.

Multicarrier waveform files require the corresponding digital standard options (R&S SMW-K2xx) of all included standards.

### 5.11.2 About the multicarrier waveforms

This chapter provides background information on the ARB functionality for generating of multicarrier signals and the impact of the provided settings. See [Section 5.11.4, "Using the multicarrier function"](#), on page 406 for information on how to use the provided settings to configure a multicarrier signal.

The multicarrier waveforms are a convenient way to configure the broadband test signals required for transmitter or receiver tests. Even complex multicarrier scenarios composed of signals from different digital standards can be created and used for these tests.

Because the multicarrier files are processed by the ARB, the composed waveform file must be created before it is loaded to and played by the ARB. The R&S SMW200A saves the created multicarrier waveform file under a user-definable name; as with the single carrier waveforms, the used file extension is \*.wv. The instrument appends additional information to the header of the composed waveform file. When the created waveform is loaded, the graphical interface displays information on clock rate, number of samples and creation day.

#### Multicarrier waveforms versus multicarrier continuous wave signals

By default, the ARB multicarrier waveform application does not generate multicarrier continuous wave signals (CW) that are aligned to the center frequency. Signals generated by the digital standard "Multi Carrier CW" are aligned to the center frequency.

To generate a multicarrier CW, create a constant DC input signal, see ["Create Test Signal"](#) on page 313. Select a signal period that is matching the carrier frequency distances.

To reach a smooth transition between end and start signal, make sure that the actual carrier frequency offset is rounded: Select "Mode" > "Equidistant Carrier Spacing" to set a frequency resolution that is the inverse of the signal period of the output signal. See [Section 5.11.2.1, "Defining the carrier frequency"](#), on page 392.

### General principle for composing the multicarrier signal

The following is a list of the general steps used for composing the multicarrier signal:

- In the default mode, the up to 512 carriers are equally spaced and centered toward the RF frequency or the baseband DC line.  
The carrier spacing is adjustable within the total available bandwidth. Make sure that the total RF bandwidth of the composed multicarrier signal does not exceed the available RF bandwidth.
- Another possibility is to define the center frequency of each of the carrier individually, see also [Section 5.11.2.1, "Defining the carrier frequency"](#), on page 392.
- Define each carrier separately in terms of power, phase and modulated input signal.  
To define the leveling of the composed multicarrier signal, use the parameter "Power Reference", see ["Power Reference"](#) on page 398.
- Optionally, optimize the crest factor of the multicarrier output signal, see [Section 5.11.2.2, "Optimizing the crest factor"](#), on page 393.
- After all multicarrier processing steps are completed, the instrument calculates the resulting peak and RMS power over the total signal. This value is then written in the waveform file.

For more information, refer to the specifications document.

#### 5.11.2.1 Defining the carrier frequency

There are two ways to define the carrier frequency of the individual carriers in the multicarrier signal:

- Enable the arbitrary carrier frequency distribution and specify the carrier frequency of each carrier individually.
- Use the built-in equidistant carrier spacing distribution function.

#### About equidistant carrier spacing

Equidistant carrier spacing implies a uniform distribution around the RF frequency. This method derives the carrier frequencies automatically from the selected number of carriers and the carrier spacing.

The maximum carrier spacing  $\Delta f_{\max}$  is a function of the available total bandwidth  $f_{\text{tot}}$  and the selected number of carriers  $n$ . Calculate  $\Delta f_{\max}$  as follows:

$$\Delta f_{\max} = \frac{f_{\text{tot}}}{n - 1}$$



The method rounds the value of the carrier spacing  $\Delta f_{\text{round}}$  so that the carrier that is closest to the center RF frequency shows no phase jump. Also, this method holds for unmodulated carriers only. Rounding includes the output signal duration  $t_{\text{output}}$  and the actual carrier spacing  $\Delta f$  as follows:

- For an odd number of carriers:

$$\Delta f_{\text{round}} \simeq \frac{1}{t_{\text{output}}} * [\Delta f * t_{\text{output}}]$$

- For an even number of carriers:

$$\Delta f_{\text{round}} \simeq \frac{2}{t_{\text{output}}} * [0.5 * \Delta f * t_{\text{output}}]$$

To avoid wrap-around problems, you can slightly modify the effective applied carrier spacing. See also ["Mode"](#) on page 395.

### 5.11.2.2 Optimizing the crest factor

An introduction to the topic is provided in [Section 5.5.1.9, "Methods for optimizing the crest factor"](#), on page 249. This section focuses on the settings provided for and related to the multicarrier signals.

The R&S SMW200A provides a crest factor reduction by an automatic optimization upon selected values for the following parameters:

- **"Crest Factor Mode":**  
This mode offers multicarrier output signals with minimized or maximized target crest factor values via internal phase corrections of the single carriers. For a disabled mode ("Off"), there are no phase corrections.
- **"Clipping":**  
Clipping reduces the peak power of the output multicarrier signal. The clipped peak power level is the sum of the RMS level of the unclipped multicarrier signal and the parameter "Target Crest Factor".  
Because clipping also reduces the RMS level, the resulting crest factor of the clipped signal is slightly above the "Target Crest Factor".
- **"Target Crest Factor":**  
Sets the target crest factor. A value above the crest factor of the unclipped multicarrier signal has no effect.
- **"Filter Cut Off Frequency":**  
This frequency is the lowpass filter frequency. If the cutoff frequency equals half of the output sample rate, a final lowpass filter improves the spectrum of the clipped multicarrier signal. But lowpass filtering can also increase the resulting crest factor.

### 5.11.3 Multicarrier settings

Access:

- ▶ Select "Baseband" > "ARB" > "General" > "Create Multi Carrier".

The "ARB: Multi Carrier" dialog opens. It provides general settings to configure the carrier distribution around the center frequency and to improve the output signal characteristics.

The tab "Carrier Table" allows selecting a waveform file per carrier. Use the "Carrier Graph" to visualize the configured signal.

The remote commands to define these settings are described in "[Multicarrier commands](#)" on page 1120.

#### Settings:

• <a href="#">General settings</a> .....	394
• <a href="#">Output settings</a> .....	400
• <a href="#">Carrier table settings</a> .....	401
• <a href="#">Carrier table assistant</a> .....	403
• <a href="#">Carrier graph</a> .....	406

### 5.11.3.1 General settings

Access:

- ▶ Select "Create Multi Carrier" > "General" > "General Settings".

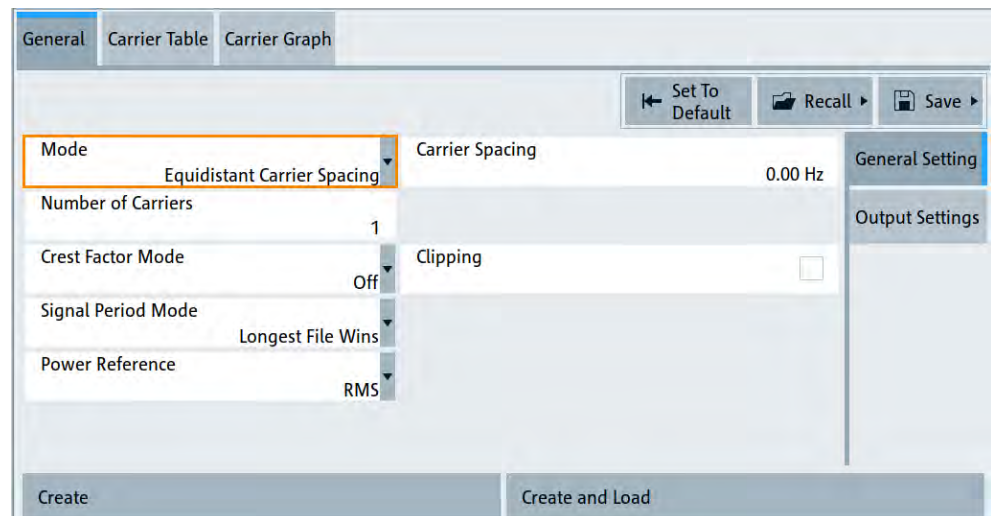

This tab provides settings to select the output waveform file, to enable signal generation and to configure the distribution of the carriers.

#### Settings:

<a href="#">Set to Default</a> .....	395
<a href="#">Save/Recall</a> .....	395
<a href="#">Mode</a> .....	395
<a href="#">Number of Carriers</a> .....	395
<a href="#">Carrier Spacing</a> .....	396
<a href="#">Crest Factor Mode</a> .....	396

Clipping.....	396
Target Crest Factor.....	396
Filter Cut Off Frequency.....	397
Signal Period Mode.....	397
Signal Period Mode.....	397
Power Reference.....	398
Create/Create and Load.....	399

### Set to Default

Calls the default settings.

Parameter	Value
"Number of Carriers"	"1"
"Carrier Spacing"	"0.00 Hz"
"Crest Factor Mode"	"Off"
"Signal Period Mode"	"Longest File Wins"

Remote command:

`[ :SOURce<hw> ] :BB:ARbitrary:MCARrier:PRESet` on page 1121

### Save/Recall

Opens the standard "Save"/"Recall" dialog that is the standard instrument function for saving and recalling the complete dialog-related settings.

Save multicarrier settings in files with file extension `*.arb_multcarr`. Define the file-name and the directory of the file.

Remote command:

`[ :SOURce<hw> ] :BB:ARbitrary:MCARrier:SETTing:CATalog?` on page 1121

`[ :SOURce<hw> ] :BB:ARbitrary:MCARrier:SETTing:LOAD` on page 1121

`[ :SOURce<hw> ] :BB:ARbitrary:MCARrier:SETTing:STORE` on page 1122

### Mode

Selects the way that the carriers are distributed within the available bandwidth.

"Equidistant Carrier Spacing"

Sets an equidistant carrier spacing distribution, i.e. the carriers are equally spaced and centered toward the RF frequency. The carrier frequencies are automatically calculated depending on the selected number of carriers and the carrier spacing.

"Arbitrary Carrier Frequency"

Set the carrier frequency of each carrier individually.

Remote command:

`[ :SOURce<hw> ] :BB:ARbitrary:MCARrier:CARRier:MODE` on page 1122

### Number of Carriers

Sets the number of carriers for the multicarrier waveform. By default the multicarrier table lists one carrier. A maximum of 512 carriers can be configured and activated.

When the number of carriers is increased, new lines are added at the end of the table. If these carriers already have been defined before, the settings are preset according to the former settings. Otherwise the parameters are preset with the default values.

See also [Section 5.11.2.1, "Defining the carrier frequency"](#), on page 392.

Remote command:

`[ :SOURce<hw> ] :BB:ARbitrary:MCARrier:CARRier:COUNT` on page 1122

### Carrier Spacing

Sets the frequency spacing between adjacent carriers of the multicarrier waveform.

The distribution of the carriers is symmetric around the RF carrier. See also [Section 5.11.2.1, "Defining the carrier frequency"](#), on page 392.

For more information, refer to the specifications document.

Remote command:

`[ :SOURce<hw> ] :BB:ARbitrary:MCARrier:CARRier:SPACing` on page 1122

### Crest Factor Mode

Selects the mode for optimizing the crest factor by calculating the carrier phases. See also [Section 5.11.2.2, "Optimizing the crest factor"](#), on page 393.

The following modes are available:

- |            |  |
|------------|--|
| "Off"      | There is no automatic setting for minimizing or maximizing the crest factor. The "Phase" setting as defined in the carrier table is in use.    |
| "Minimize" | The crest factor is minimized by internally calculating optimized carrier phases. The phase setting displayed in the carrier table is invalid. |
| "Maximize" | The crest factor is maximized by internally calculating optimized carrier phases. The phase setting displayed in the carrier table is invalid. |

Remote command:

`[ :SOURce<hw> ] :BB:ARbitrary:MCARrier:CFACTOR:MODE` on page 1123

### Clipping

Enables baseband signal clipping.

Clipping reduces the peak power of the resulting multicarrier signal according to the input parameter "Target Crest Factor". See also, [Section 5.11.2.2, "Optimizing the crest factor"](#), on page 393.

Remote command:

`[ :SOURce<hw> ] :BB:ARbitrary:MCARrier:CLIPping[:STATe]` on page 1124

### Target Crest Factor

Requires "Clipping" > "On".

Sets the value of the target crest factor. A "Target Crest Factor" above the crest factor of the unclipped multicarrier signal has no effect. See also [Section 5.11.2.2, "Optimizing the crest factor"](#), on page 393.

Remote command:

`[ :SOURce<hw> ] :BB:ARbitrary:MCARrier:CLIPping:CFACTOR` on page 1124

**Filter Cut Off Frequency**

Requires "Clipping" > "On".

Sets the cutoff frequency of the lowpass filter before the output of the multicarrier signal.

See also [Section 5.11.2.2, "Optimizing the crest factor"](#), on page 393.

Remote command:

`[ :SOURce<hw> ] :BB:ARbitrary:MCARrier:CLIPping:CUToff` on page 1124

**Signal Period Mode**

Defines the way the resulting signal period of the multicarrier waveform is calculated. The resulting period is always calculated for all carriers in the carrier table irrespective of their state (ON/OFF). Use the "Carrier Table" > "Info" function to obtain information on the sample rate and file length data of each carrier.

**Note:** Wrap-around and timing problems can occur when I/Q signals of different length are used. Thus, demodulation of a carrier can be difficult or even impossible.

We recommend that you proceed as follows:

- Consider the timing when creating the input I/Q files.
- Adjust the signal duration to the carrier which is then demodulated.  
Other carriers interfere with the signal.

These problems do not arise with signals of the same standard, for example, 3GPP signals.

The following modes are available:

"Longest File Wins"

The longest I/Q file in the carrier table defines the resulting signal period. Shorter I/Q files are periodically repeated.

"Shortest File Wins"

The shortest I/Q file in the carrier table defines the resulting signal period. Longer I/Q files only use the first part.

"User"

Sets the signal period manually, see ["Signal Period Mode"](#) on page 397. Repeats shorter I/Q files periodically and uses only the first part of longer I/Q files.

"Least Common Multiple"

The output file duration is the least common multiple of all input file durations.

Remote command:

`[ :SOURce<hw> ] :BB:ARbitrary:MCARrier:TIME:MODE` on page 1125

**Signal Period Mode**

Sets the signal period in signal duration mode "User". Repeats shorter I/Q files periodically and for longer I/Q files, uses only the first part.

Remote command:

`[ :SOURce<hw> ] :BB:ARbitrary:MCARrier:TIME` on page 1123

**Power Reference**

Sets the method of leveling individual carriers in a composed multicarrier signal. The difference between the provided modes is especially important if signals with different crest factors are composed together into a multicarrier signal.

"RMS"            The individual carriers are leveled based on their RMS power and the configured "Carrier Gain".

**Example:**

A multicarrier signal is composed from two waveform files.

First carrier "Gain" = 0 dB

Second carrier "Gain" = -3 dB

In the resulting multicarrier signal, the *RMS power* of the second carrier signal is 3 dB lower than the RMS power of the first carrier signal.

"Peak" The individual carriers are leveled based on their peak power and the configured "Carrier Gain".

#### Example:

A multicarrier signal is composed from two waveform files.

First carrier "Gain" = 0 dB

Second carrier "Gain" = -3 dB

In the resulting multicarrier signal, the *peak power* of the second carrier signal is 3 dB lower than the peak power of the first carrier signal.

#### Example: Multicarrier signal composed of waveforms with different crest factor

A multicarrier signal is composed from two waveform files with the following characteristics:

3GPP FDD signals with the same "Sample Rate" but *different "Crest Factors"*.

"Peak" = 0 dBFS

"Carrier Gain" = 0 dB

State	Carrier Freq. Offs. (MHz)	Gain (dB)	Phase (deg)	Delay (ns)	File	Info	!!!
0 On	0.000 000	0.00	0.00	0	/opt/data/Lists/Arb/ArbMccwDummy.wv	Info...	
1 On	0.000 000	0.00	0.00	0	/opt/data/Lists/Arb/ArbMccwDummy.wv	Info...	!

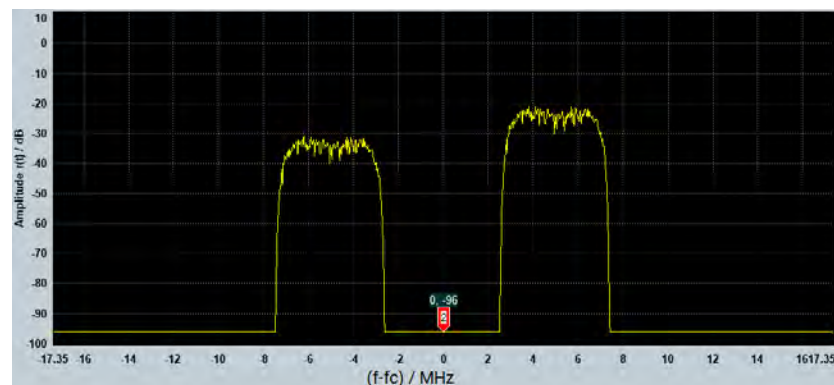

The peak values of the carrier signals are equal, but the RMS values are different.

Remote command:

[\[:SOURce<hw>\]:BB:ARbitrary:MCARrier:POWER:REference](#) on page 1125

#### Create/Create and Load

Creates a multicarrier waveform defined by the multicarrier table and general setting entries.

If you start the calculation with the "Create and Load" function, the instrument creates the waveform and loads it in the ARB.

Also, saves this multicarrier waveform with filename as set in "Output File". Depending on the configuration of the multicarrier waveform, calculation can take some time. To stop the calculation, use the "Abort" function.

Remote command:

[\[:SOURce<hw>\]:BB:ARbitrary:MCARrier:CREate](#) on page 1126

[\[:SOURce<hw>\]:BB:ARbitrary:MCARrier:CLoad](#) on page 1125

### 5.11.3.2 Output settings

Access:

- ▶ Select "Create Multi Carrier" > "General Settings" > "Output Settings"

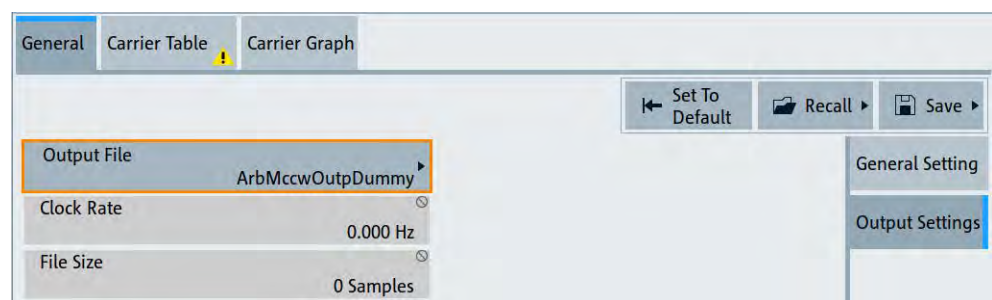

This tab displays settings of the output file and related output multicarrier signal. These settings include the output filename, the clock rate and the file size.

#### Settings:

<a href="#">Output File</a> .....	400
<a href="#">Clock Rate</a> .....	400
<a href="#">File Size</a> .....	401

#### Output File

Opens a standard "File Select" dialog to set the output filename of the multicarrier waveform to be calculated. As with normal waveforms, the file extension is \*.wv.

To trigger the calculation and storage of this multicarrier waveform, select "Create" or "Create and Load".

Remote command:

[\[:SOURce<hw>\]:BB:ARbitrary:MCARrier:OFILe](#) on page 1125

#### Clock Rate

Displays the resulting sample rate during the output of the multicarrier waveform is output at the ARB.

The output clock rate depends on the following:

- Number of carriers
- Carrier spacing
- Input sample rate of the leftmost or rightmost carriers.



Remote command:

[ :SOURce<hw> ] :BB:ARbitrary:MCARrier:CLOCK? on page 1126

### File Size

Displays the resulting number of samples of the multicarrier waveform.

Remote command:

[ :SOURce<hw> ] :BB:ARbitrary:MCARrier:SAMPles? on page 1123

### 5.11.3.3 Carrier table settings

Access:

- ▶ Select "Create Multi Carrier" > "Carrier Table"

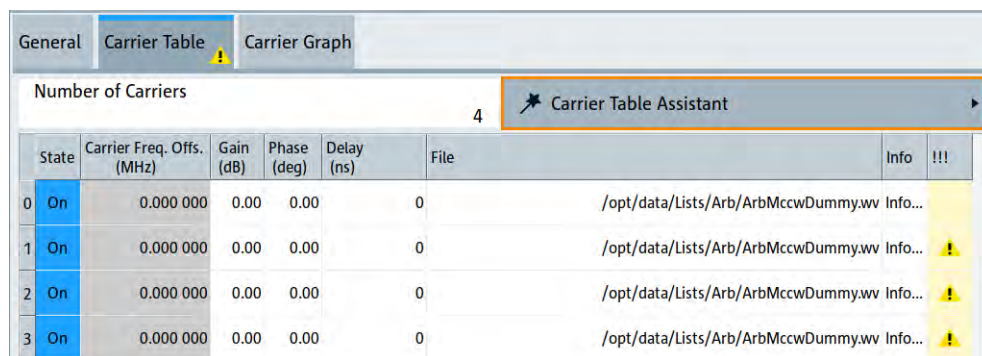

This tab provides the settings to configure the number of carriers and set individual carrier characteristics in a table. The number of lines equals the number of carriers. Note that valid phase settings "Phase ( deg)" require disabled crest factor optimization: "Crest Factor Mode" > "Off".

Optionally, use the "Carrier Table Assistant" for simplified configuration of the individual carriers, see [Section 5.11.3.4, "Carrier table assistant"](#), on page 403. Use the "Carrier Graph" tab to visualize the configured multicarrier signal including its individual carriers, see [Section 5.11.3.5, "Carrier graph"](#), on page 406.

### Settings:

<a href="#">Number of Carriers</a> .....	402
<a href="#">Carrier number</a> .....	402
<a href="#">State</a> .....	402
<a href="#">Carrier Freq. Offs. (MHz)</a> .....	402
<a href="#">Gain (dB)</a> .....	402
<a href="#">Phase (deg)</a> .....	402
<a href="#">Delay (ns)</a> .....	402
<a href="#">File</a> .....	402
<a href="#">Info</a> .....	403
<a href="#">!!!</a> .....	403

**Number of Carriers**

Defines the number of carriers of the multicarrier waveform, see "Number of Carriers" on page 395.

Remote command:

`[ :SOURce<hw> ] :BB:ARbitrary:MCARrier:CARRier:COUNT` on page 1122

**Carrier number**

Displays the number of an individual carrier. The numbering of these carriers ranges from 0 to the number of carriers - 1.

Remote command:

Set via suffix `CARRier<ch>`.

**State**

Enables an individual carrier.

Remote command:

`[ :SOURce<hw> ] :BB:ARbitrary:MCARrier:CARRier<ch>:STATe` on page 1126

**Carrier Freq. Offs. (MHz)**

Displays the carrier frequency offset. This offset indicates

**Note:** The carrier frequency can only be set in "Arbitrary Carrier frequency" mode. For "Equidistant Carrier Spacing", the carrier spacing is determined automatically.

Remote command:

`[ :SOURce<hw> ] :BB:ARbitrary:MCARrier:CARRier<ch>:FREQuency`  
on page 1127

**Gain (dB)**

Sets the gain of a carrier.

Remote command:

`[ :SOURce<hw> ] :BB:ARbitrary:MCARrier:CARRier<ch>:POWer` on page 1127

**Phase (deg)**

Sets the starting phase of a carrier.

Remote command:

`[ :SOURce<hw> ] :BB:ARbitrary:MCARrier:CARRier<ch>:PHASe` on page 1127

**Delay (ns)**

Sets the starting delay of a carrier.

Remote command:

`[ :SOURce<hw> ] :BB:ARbitrary:MCARrier:CARRier<ch>:DELay` on page 1128

**File**

Opens the standard "File Select" function for selecting the input file. The input file contains the I/Q signal that is modulated onto the carrier.

Remote command:

`[ :SOURce<hw> ] :BB:ARbitrary:MCARrier:CARRier<ch>:FILE` on page 1128

**Info**

Opens a waveform information dialog. This dialog lists the sample rate, the number of I/Q value pairs (number of samples) and the signal period.

Remote command:

n.a.

**!!!**

Indicates a conflict with a warning triangle. A conflict arises when the carriers overlap and is also indicated in the header of the "Carrier Table" tab.

Remote command:

`[ :SOURce<hw> ] :BB:ARbitrary:MCARrier:CARRier<ch>:CONFLICT?`  
on page 1128

**5.11.3.4 Carrier table assistant**

Access:

1. Select "Create Multi Carrier" > "Carrier Table"
2. Select "Carrier Table Assistant".

ARB Multi Carrier Table A			
Number of Carriers	4		
Carrier Start	0	Carrier Stop	0
Carrier State	<input checked="" type="checkbox"/>		
Gain Start	0.00 dB	Gain Step	0.00 dB
Phase Start	0.00 deg	Phase Step	0.00 deg
Delay Start	0 ns	Delay Step	0 ns
Input Waveform File	ArbMccwDummy		
<input checked="" type="checkbox"/> Apply Assistant Settings			

The "Carrier Table Assistant" dialog enables the configuration of a selectable subset of carrier. The provided settings are an optional way to create a multicarrier scenario within a specified carrier range.

**Settings:**

Carrier State.....	404
Carrier Start.....	404
Carrier Stop.....	404
Gain Start.....	404
Gain Step.....	404
Phase Start.....	404
Phase Step.....	404

Delay Start.....	405
Delay Step.....	405
Input Waveform File.....	405
Apply Assistant Settings.....	405

### Carrier State

Enables the carriers in the range "Carrier Start" to "Carrier Stop".

Remote command:

`[ :SOURCE<hw> ] :BB:ARbitrary:MCARrier:EDIT:CARRier:STATe` on page 1128

### Carrier Start

Sets the carrier start that is the first individual carrier for which the carrier assistant settings apply.

Remote command:

`[ :SOURCE<hw> ] :BB:ARbitrary:MCARrier:EDIT:CARRier:START` on page 1129

`[ :SOURCE<hw> ] :BB:ARbitrary:MCARrier:EDIT:CARRier:STOP` on page 1129

### Carrier Stop

Sets the carrier stop that is the last individual carrier for which the carrier assistant settings apply.

Remote command:

`[ :SOURCE<hw> ] :BB:ARbitrary:MCARrier:EDIT:CARRier:START` on page 1129

`[ :SOURCE<hw> ] :BB:ARbitrary:MCARrier:EDIT:CARRier:STOP` on page 1129

### Gain Start

Sets the gain of the carrier marked by "Carrier Start".

Remote command:

`[ :SOURCE<hw> ] :BB:ARbitrary:MCARrier:EDIT:CARRier:POWER[:START]`

on page 1129

### Gain Step

Sets the step size that is used to increment the gain.

The resulting carrier gain in the carrier table equals:

$$\textit{Gain} = \textit{Gain Start} + n \cdot \textit{Gain Step}.$$

$n$  is a value between 0 and the difference of "Carrier Stop" and "Carrier Start".

Remote command:

`[ :SOURCE<hw> ] :BB:ARbitrary:MCARrier:EDIT:CARRier:POWER:STEP`

on page 1129

### Phase Start

Sets the phase of the carrier marked by "Carrier Start".

Remote command:

`[ :SOURCE<hw> ] :BB:ARbitrary:MCARrier:EDIT:CARRier:PHASE[:START]`

on page 1130

### Phase Step

Sets the step size that is used to increment the phase.

The resulting phase in the carrier table equals:

$$\text{Phase} = \text{"Phase Start"} + n * \text{"Phase Step"}$$

$n$  is a value between 0 and the difference of "Carrier Stop" and "Carrier Start".

Remote command:

```
[ :SOURce<hw> ] :BB:ARbitrary:MCARrier:EDIT:CARRier:PHASe:STEP  
on page 1130
```

### Delay Start

Sets the delay of the carrier marked by "Carrier Start".

Remote command:

```
[ :SOURce<hw> ] :BB:ARbitrary:MCARrier:EDIT:CARRier:DELay[:START]  
on page 1131
```

### Delay Step

Sets the step size that is used to increment the delay.

The resulting delay in the carrier table equals:

$$\text{Delay} = \text{"Delay Start"} + n * \text{"Delay Step"},$$

$n$  is a value between 0 and the difference of "Carrier Stop" and "Carrier Start".

Remote command:

```
[ :SOURce<hw> ] :BB:ARbitrary:MCARrier:EDIT:CARRier:DELay:STEP  
on page 1130
```

### Input Waveform File

Opens the standard "File Select" function for selecting the input file. The input file contains the I/Q modulation signal for all carriers of the selected carrier range.

Remote command:

```
[ :SOURce<hw> ] :BB:ARbitrary:MCARrier:EDIT:CARRier:FILE on page 1131
```

### Apply Assistant Settings

Transfers the assistant settings to the carrier table.

Remote command:

```
[ :SOURce<hw> ] :BB:ARbitrary:MCARrier:EDIT:CARRier:EXECute  
on page 1131
```

### 5.11.3.5 Carrier graph

Access:

- ▶ Select "Create Multi Carrier" > "Carrier Graph".

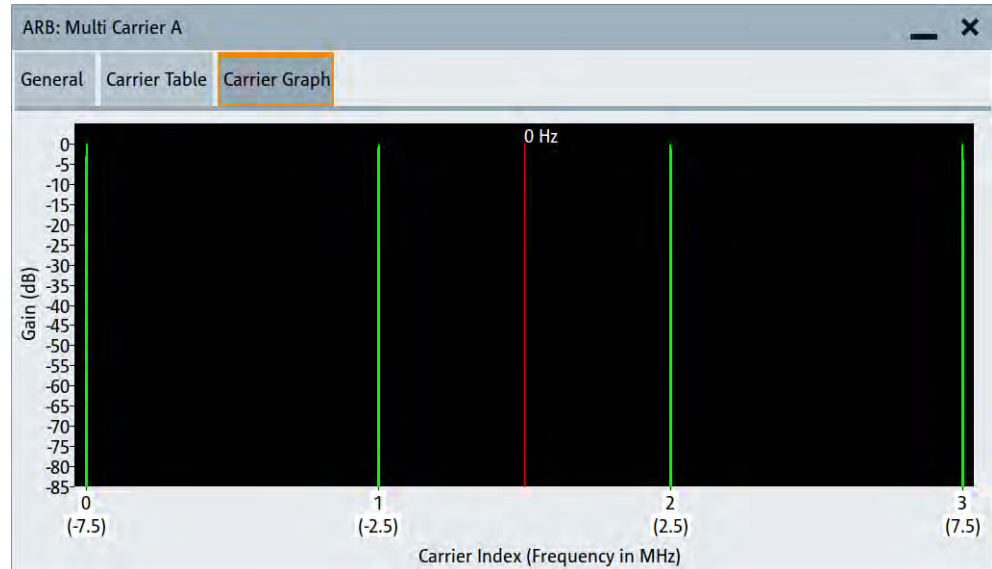

The carrier graph is a graphical representation of the current multicarrier configuration in the frequency domain.

The height of the bars corresponds to the gain of each individual carrier. The bars width indicates the bandwidth of the carriers signals.

### 5.11.4 Using the multicarrier function

This section provides step-by-step instructions on how to configure and use the multicarrier settings.

#### To create a multicarrier waveform file

1. To configure the general settings, select "Baseband" > "ARB" > "General".
2. To configure the carrier table, select "ARB" > "Multi Carrier" > "Carrier Table"
3. To enter the filename of the multicarrier waveform, select "ARB" > "Multi Carrier" > "Output File"
4. To save or load a multicarrier waveform, select "ARB" > "Multi Carrier" > "Create" or "Create and Load".

#### To generate a multicarrier signal for standard transmitter tests

High-power amplifiers of multicarrier base stations face increased requirements in terms of linearity and acceptable intermodulation performance.

To set up a standard transmitter test, proceed as follows:

1. Open the "Baseband" > "3GPP FDD" dialog. Proceed as follows:
  - a) Select "3GPP FDD" > "Basestations" > "Test Setups/Models".
  - b) Select "3GPP FDD: Downlink/Test Model" > "Test\_Model\_1\_16channels".
  - c) To confirm, tap "Select".
2. To enable signal generation, select "3GPP FDD" > "General" > "On".
3. To create a 3GPP ARB file, select "3GPP FDD" > "Generate Waveform".  
Enter the name of the waveform that you want to generate, for example:  
3gpp\_1\_16.
4. Confirm with "Save"
5. To set up a multicarrier scenario with 4 carriers and a carrier spacing of 5 MHz, select "Baseband" > "ARB" > "Create Multi Carrier".  
Perform the following:
  - a) In the "General" dialog, select "Number of Carriers" = "4" and "Carrier Spacing" = "5 MHz".
  - b) To load the generated waveform file to all 4 carriers, select "Carrier Table" > "Carrier Table Assistant".
  - c) Select "Carrier Start" = "0" and "Carrier Stop" = "3".
  - d) To load the generated waveform file to all 4 carriers, select "ARB Multi Carrier Table" > "Input Waveform File".
  - e) Select the generated waveform file 3gpp\_1\_16.
  - f) Select "ARB Multi Carrier Table" > "Carrier State" > "On".

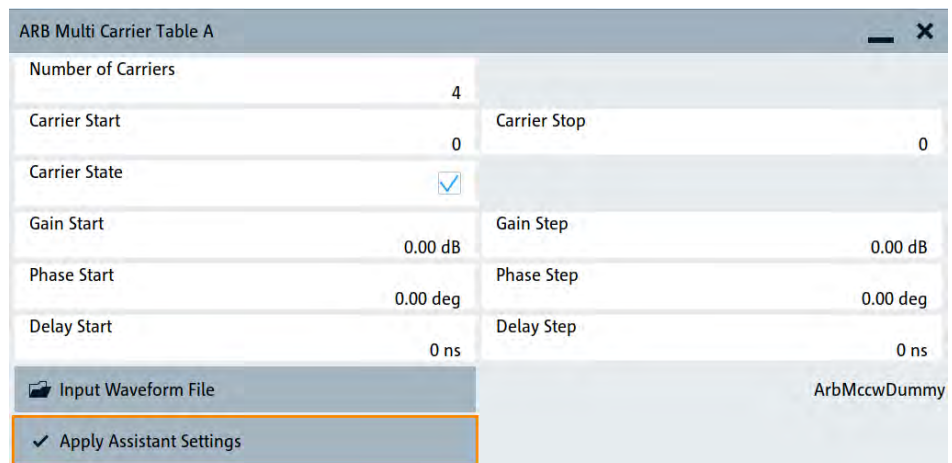

- g) Select "ARB Multi Carrier Table" > "Apply Assistant Settings".
- h) Close the dialog.

The "ARB: Multi Carrier" > "Carrier Table" dialog confirms the configuration.

General		Carrier Table	Carrier Graph				
Number of Carriers		4		Carrier Table Assistant			
State	Carrier Freq. Offs. (MHz)	Gain (dB)	Phase (deg)	Delay (ns)	File	Info	!!!
0 On	0.000 000	0.00	0.00	0	/opt/data/Lists/Arb/ArbMccwDummy.wv	Info...	
1 On	0.000 000	0.00	0.00	0	/opt/data/Lists/Arb/ArbMccwDummy.wv	Info...	!
2 On	0.000 000	0.00	0.00	0	/opt/data/Lists/Arb/ArbMccwDummy.wv	Info...	!
3 On	0.000 000	0.00	0.00	0	/opt/data/Lists/Arb/ArbMccwDummy.wv	Info...	!

6. Select "ARB: Multi Carrier" > "Carrier Graph" to visualize the configuration.

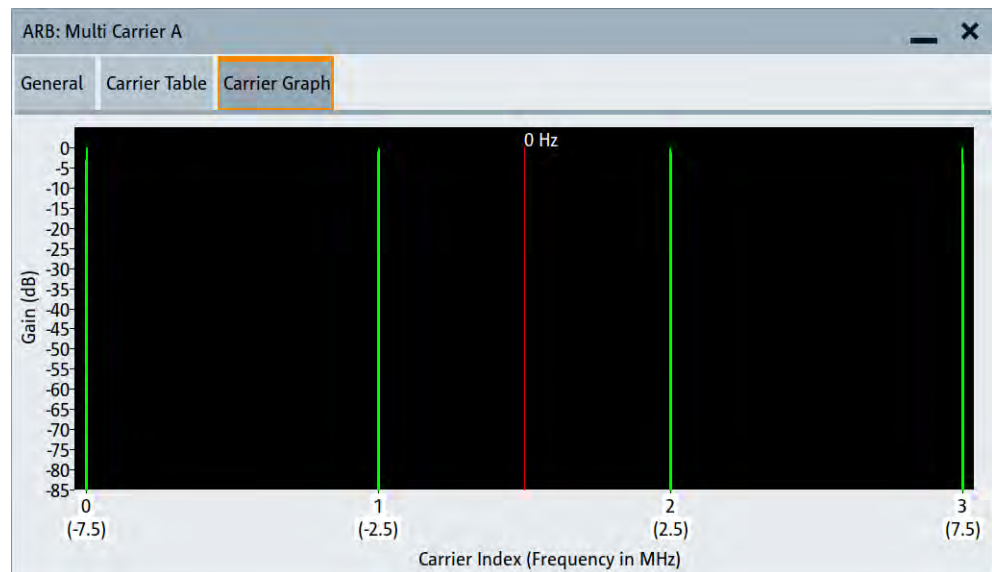

7. Select "ARB: Multi Carrier" > "General" > "Output Settings" > "Output File".
8. Enter the name of the output file, for example `4x5MHz_3gpp_1_16`.
9. To load the waveform in the ARB, select "ARB: Multi Carrier" > "General" > "Create" or "Create and Load".
10. Select "ARB" > "General" > "Load Waveform", to select the multicarrier output file.
11. Select "ARB" > "State" > "On" to enable the ARB.

## 5.12 Generating multicarrier continuous wave signals

The multicarrier continuous wave (MCCW) is a firmware option that enables the R&S SMW200A to calculate up to 160001 continuous wave signals.



### 5.12.1 Required options

The equipment layout for processing of waveform files includes:

- Option standard or wideband baseband generator (R&S SMW-B10/-B9) per signal path
- Option baseband main module, one/two I/Q paths to RF (R&S SMW-B13/-B13T) or Option wideband baseband main module two I/Q paths to RF (R&S SMW-B13XT)
- Option multicarrier CW (R&S SMW-K61) per signal path

### 5.12.2 About MCCW

The R&S SMW200A can calculate and generate a multicarrier continuous wave (MCCW) signal that consists of up to 8192 unmodulated carriers. The carrier offset and the power level of the carriers are user-definable. The provided settings allow individual configuration of each carrier and the joint configuration of a subset of carriers. Automatic start phase setting is provided to minimize the crest factor.

The R&S SMW200A does not generate MCCW signals in real time but computes them in arbitrary waveform mode. For example, you need to accept real-time changes in the carrier settings before the instrument applies them.

The common application fields of the MCCW signals are the receiver tests with broadband test signals.

### 5.12.3 MCCW settings

Access:

- ▶ Select "Baseband" > "Multi Carrier CW".

The dialog enables direct carrier configuration, access to the carrier table and the graphical representation of the configured carriers.

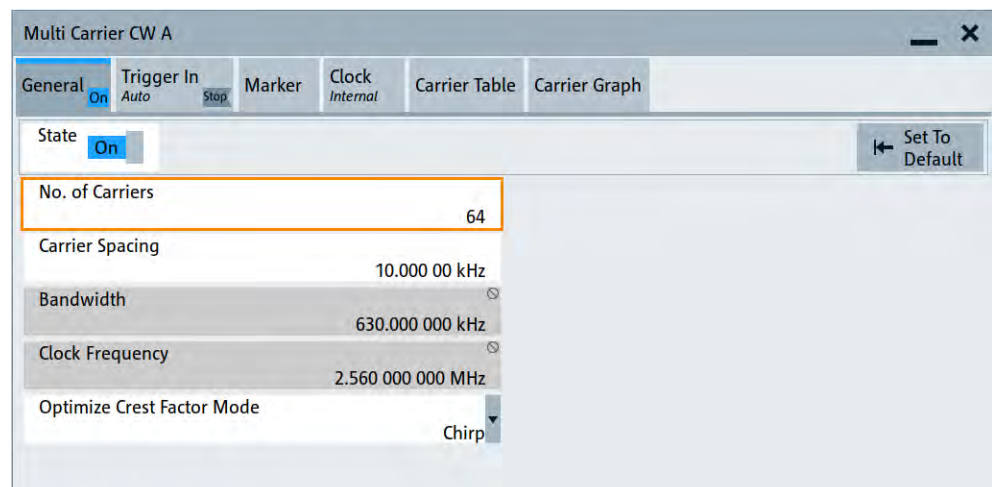

The remote commands required to define these settings are described in [Section 14.19.5.4, "SOURce:BB:MCCW subsystem"](#), on page 1149.

### Settings:

#### 5.12.3.1 General carrier settings

Access:

- ▶ Select "Baseband" > "Multi Carrier CW".

### Settings:

State.....	410
Set to Default.....	410
Number of Carriers.....	410
Carrier Spacing.....	411
Bandwidth.....	411
Clock Frequency.....	411
Optimize Crest Factor Mode.....	411
Desired Crest Factor.....	412

### State

Enables MCCW signal generation.

Switching on this option, turns off all the other digital standards and digital modulation modes in the corresponding signal path.

MCCW signals are computed in arbitrary waveform mode. To adopt the changes in the settings of individual carriers, select "Accept". This selection applies to the settings in the "Table Setup Assistant" section and the "Carrier Table" dialog.

Remote command:

[ :SOURce<hw> ] :BB:MCCW:STATe on page 1155

### Set to Default

Calls the default settings, see [Table 5-27](#).

Remote command:

[ :SOURce<hw> ] :BB:MCCW:PRESet on page 1154

### Number of Carriers

Sets the number of carriers composing the MCCW signal.

**Note:** Cross-reference between total bandwidth, carrier spacing, and number of carriers. The total bandwidth of the multicarrier CW signal is calculated as follows:

Total Bandwidth = ("Number of Carriers" - 1) \* "Carrier Spacing"

The result must not exceed the system bandwidth of the instrument.

For more information, refer to the specifications document.

If the total bandwidth is not respected, the value selected as "Carrier Spacing" is reduced. Hence, the selected number of carriers defines the maximum carrier spacing.

By default, the multicarrier table lists 64 carriers that are preset to the settings: "State" = "On", "Power" = "0 dB", "Phase" = "0°".

If the selected number of carriers is less than the carriers in the table, the superfluous table rows are deleted. If the number of carriers exceeds the number of table rows, new rows are appended to the table.

Remote command:

`[ :SOURce<hw> ] :BB:MCCW:CARRier:COUNT` on page 1155

### Carrier Spacing

Sets the spacing between carriers for the MCCW signal. The carriers are arranged symmetrically around the HF carrier.

Remote command:

`[ :SOURce<hw> ] :BB:MCCW:CARRier:SPACing` on page 1155

### Bandwidth

Indicates the resulting occupied signal bandwidth, calculated from the selected [Number of Carriers](#) and [Carrier Spacing](#).

### Clock Frequency

Displays the clock rate.

The arbitrary waveform generator outputs the MCCW signal at this rate. The output clock rate depends on the number of carriers and the selected carrier offset.

The value indicates the resolution during the marker generation.

Remote command:

`[ :SOURce<hw> ] :BB:MCCW:CLOCK?` on page 1156

### Optimize Crest Factor Mode

Selects the mode for automatically minimizing the crest factor. The carrier start phases are automatically configured according to the selected mode.

Methods of reducing the crest factor differ regarding both the optimization achievable and the time required for computation. For more information, refer to [Section 5.5.1.9, "Methods for optimizing the crest factor"](#), on page 249.

- |         |   |
|---------|---|
| "Off"   | There are no automatic settings for minimizing the crest factor. Use the "Phase" parameter to set the start phase.  |
| "Chirp" | <p>Rapid crest factor optimization regardless of the number of carriers.</p> <p>The minimal crest factor is 3 dB if the following prerequisites are fulfilled:</p> <ul style="list-style-type: none"> <li>• All carriers in the multicarrier signal are switched on.</li> <li>• All carriers have identical power.</li> </ul> <p>In a configuration which differs from these prerequisites, the achievable crest factor is worse.</p> |

"Target Crest" Optimization of the crest factor to a desired value for all carrier configurations.

The optimization time depends on the number of carriers and the desired crest factor. Computation time increases only when the number of carriers exceeds 256 and the crest factor is below 4 dB. The desired value can be entered in "Desired Crest Factor".

**Note:** Optimization can be canceled at any time, and the current value being displayed at that moment is then used.

Remote command:

[ :SOURce<hw> ] :BB:MCCW:CFACTOR:MODE on page 1156

**Desired Crest Factor**

Requires "Optimize Crest Factor Mode" > "Target Crest".

Sets the desired crest factor that is the target crest factor.

Remote command:

[ :SOURce<hw> ] :BB:MCCW:CFACTOR on page 1156

**5.12.3.2 Carrier table**

Access:

- ▶ Select "Baseband" > "Multi Carrier CW" > "Carrier Table".

The provided settings enable the configuration of a selectable range of carriers.

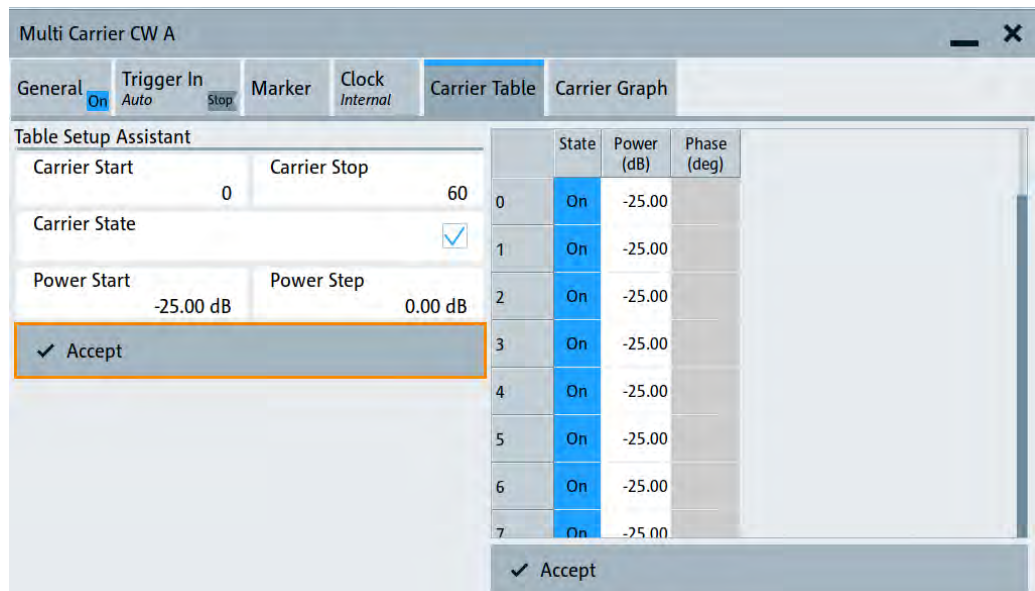

**Settings:**

Table Setup Assistant.....413

- └ Carrier Start/Stop.....413
- └ Carrier State.....413

L Power Start.....	413
L Power Step.....	413
L Phase Start.....	413
L Phase Step.....	413
L Accept.....	414
Carrier Table.....	414

### Table Setup Assistant

Enables joint configuration of a selectable range of carriers.

#### Carrier Start/Stop ← Table Setup Assistant

Defines the start/stop index of the carrier range to which the following settings are intended to apply.

Remote command:

`[ :SOURce<hw> ] :BB:MCCW:EDIT:CARRier:START` on page 1160

`[ :SOURce<hw> ] :BB:MCCW:EDIT:CARRier:STOP` on page 1160

#### Carrier State ← Table Setup Assistant

Switches the carriers in the carrier range on/off.

Remote command:

`[ :SOURce<hw> ] :BB:MCCW:EDIT:CARRier:STATe` on page 1161

#### Power Start ← Table Setup Assistant

Sets the power of the starting carrier.

Remote command:

`[ :SOURce<hw> ] :BB:MCCW:EDIT:CARRier:POWer [ :START ]` on page 1159

#### Power Step ← Table Setup Assistant

Sets the width of the step with which the power is changed from carrier to carrier.

The individual power of each carrier ("Carrier Table" > "Carrier#" > "Power") is calculated as "Power Start" + n\*"Power Step".

Remote command:

`[ :SOURce<hw> ] :BB:MCCW:EDIT:CARRier:POWer:STEP` on page 1160

#### Phase Start ← Table Setup Assistant

If "Optimize Crest Factor Mode" > "Off", sets the phase of the starting carrier.

Remote command:

`[ :SOURce<hw> ] :BB:MCCW:EDIT:CARRier:PHASe [ :START ]` on page 1159

#### Phase Step ← Table Setup Assistant

If "Optimize Crest Factor Mode" > "Off", sets the width of the step with which the phase is changed from carrier to carrier.

The individual phase of each carrier ("Carrier Table" > "Carrier#" > "Power") is calculated as "Phase Start" + n\*"Phase Step".

Remote command:

`[ :SOURce<hw> ] :BB:MCCW:EDIT:CARRier:PHASe:STEP` on page 1160

**Accept ← Table Setup Assistant**

Adopts the carrier range setting into the "Carrier Table".

Remote command:

[\[:SOURce<hw>\]:BB:MCCW:EDIT:CARRier:EXECute](#) on page 1161

**Carrier Table**

A table with settings for the configuration of the individual carriers.

The MCCW signal is only computed when the "Accept" function is triggered. Whenever the carrier table contains settings that have not yet been adopted with the "Accept" function, the background is yellow.

**Note:** The phase/deg settings are only valid if optimization of the crest factor is disabled ("Optimize Crest Factor" > "Off").

**Tip:** Use the [Carrier graph](#) function to display the current carrier configuration.

"No."	Carrier index.
"State"	Switches a carrier on/off.
"Power"	Sets the power of a carrier. If you use the <a href="#">Table Setup Assistant</a> settings to fill the individual carrier powers, the power of a carrier is calculated as follows: "Power Start" + n*"Power Step".
"Phase"	Sets the starting phase of a carrier. If you use the <a href="#">Table Setup Assistant</a> settings to fill the individual carrier phases, the phase of a carrier is calculated as follows: "Phase Start" + n*"Phase Step".
"Accept"	Transfers the settings in the carrier table into the instrument.

Remote command:

[\[:SOURce<hw>\]:BB:MCCW:CARRier:LIST:STATe](#) on page 1157

[\[:SOURce<hw>\]:BB:MCCW:CARRier:STATe](#) on page 1157

[\[:SOURce<hw>\]:BB:MCCW:CARRier:LIST:POWer](#) on page 1159

[\[:SOURce<hw>\]:BB:MCCW:CARRier:POWer](#) on page 1159

[\[:SOURce<hw>\]:BB:MCCW:CARRier:LIST:PHASe](#) on page 1158

[\[:SOURce<hw>\]:BB:MCCW:CARRier:PHASe](#) on page 1158

**5.12.3.3 Carrier graph**

Access:

- ▶ Select "Baseband" > "Multi Carrier CW" > "Carrier Graph".

The "Carrier Graph" tab is a graphical representation of the current carrier configuration.

The carriers are on the X-axis and the colored bars represent those carriers which are in the active state. Power is on the Y-axis, and the height of the bars corresponds to the chosen power of each individual carrier.

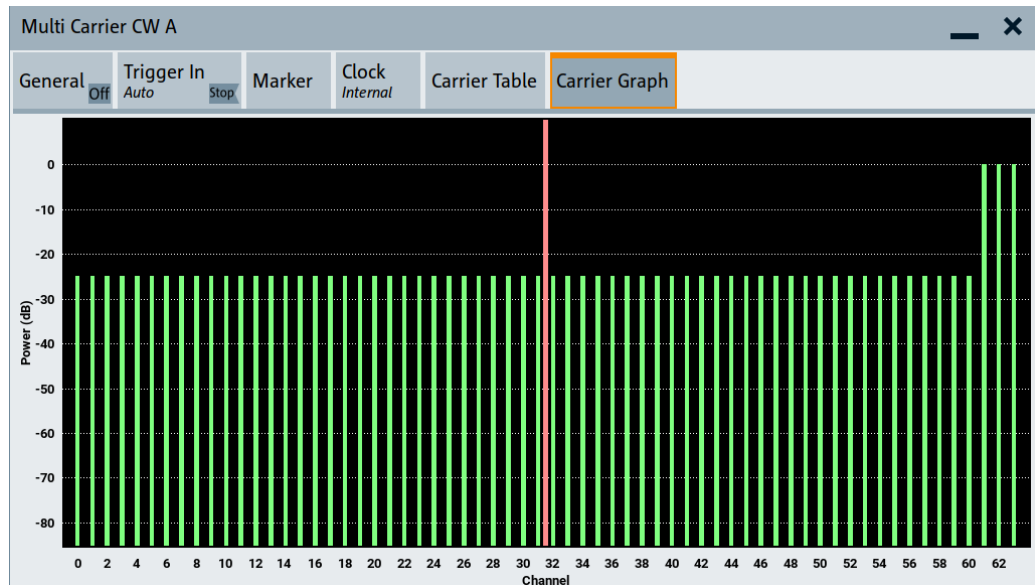

#### 5.12.3.4 Trigger, marker and clock settings

These tabs provide standard settings.

For detailed description, see:

- [Section 5.5.2.1, "Trigger settings"](#), on page 252
- [Section 5.5.2.2, "Marker settings"](#), on page 258
- [Section 5.5.2.3, "Clock settings"](#), on page 259
- [Section 5.5.2.4, "Local and global connectors settings"](#), on page 261

#### 5.12.4 Using MCCW signals

This section provides examples on how to use the multicarrier continuous wave function in some general test cases.

##### To generate a signal to test the frequency response

If the test case requires a signal for DUT testing, like power amplifier or filter with a bandwidth of 80 MHz, proceed as follows:

1. Connect the DUT to the output connectors of the instrument.
2. Connect a suitable measurement equipment, like a signal analyzer to the DUT.
3. Select "Baseband" > "Multi Carrier CW".
4. Adjust further settings, for example, trigger settings, as required.
5. Set "Multi Carrier CW" > "State" > "On".
6. Set "RF" > "On" to enable the signal output.

- On the connected signal analyzer, execute the required measurement tasks. Measure the frequency response at the outputs of the DUT.

### To generate a single sideband signal to test the image rejection

If a single sideband test signal for testing the image rejection capabilities of DUT is required, proceed as follows:

- Connect the DUT to the output connectors of the instrument.
- Connect a suitable measurement equipment, like a signal analyzer to the DUT.
- Select "Baseband" > "Multi Carrier CW" > "General":
  - Enable "No. of Carriers" = "81".
  - Set "Carrier Spacing" = "1 MHz".
- Select "Multi Carrier CW" > "Carrier Table":
  - Set "Carrier Start" = "40".
  - Set "Carrier Stop" = "80".
  - Set "Carrier State" = "Off".
  - Confirm with "Accept".

Open the "Multi Carrier CW" > "Carrier Graph" to visualize the configured single sideband signal.

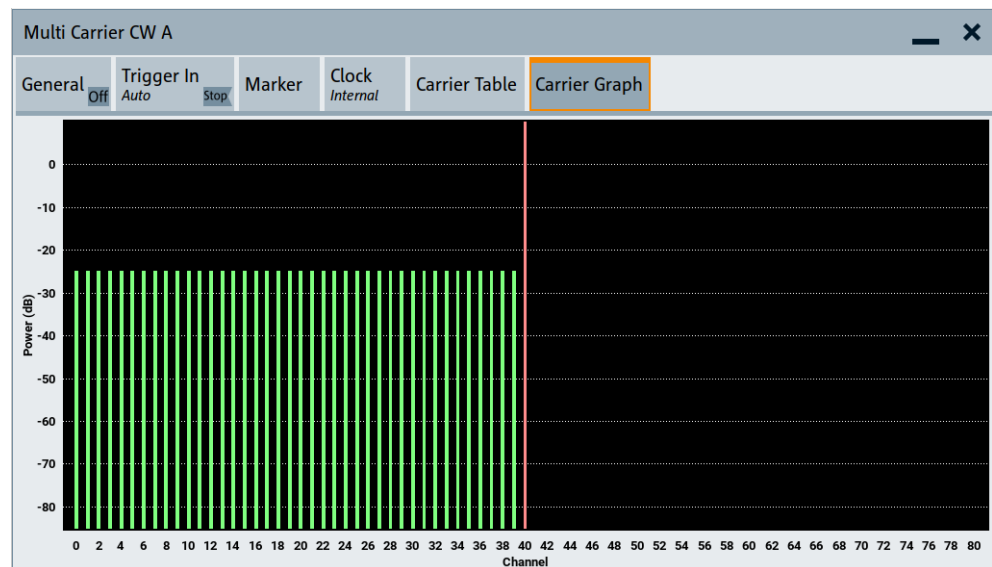

- Adjust further settings, for example, trigger settings, as required.
- Set "Multi Carrier CW" > "State" > "On".
- Set "RF" > "On" to enable the signal output.
- On the connected signal analyzer, execute the required measurement tasks. Measure the frequency response at the outputs of the DUT.



## 5.12.5 References

Table 5-27: MCCW default values

Parameter	Value
State	Not affected by "Set to Default"
<b>Carrier Setup</b>	
Number of Carriers	64
Carrier Spacing	10 kHz
Optimize Crest Factor	Chirp
Desired Crest Factor	3 dB
<b>Trigger</b>	
Mode	Auto
Source	Internal
Ext. Delay	0
Ext. Inhibit	0
<b>Marker</b>	
Channel 1...4	Restart
<b>Clock</b>	
Source	Internal
<b>Multichannel Setup</b>	
Start Carrier	0
Stop Carrier	0
State	on
Power	0 dB
Power Step	0 dB
Initial Phase	0°
Phase Step	0°
<b>Channel Setup</b>	
State	ON
Phase	0°
Power	0 dB

## 5.13 Generating a linear slope ramp waveform

Generating a linear slope ramp waveform with the baseband generator is a function that requires the additional option Baseband Power Sweep (R&S SMW-K542). The main application field of these signals is amplifier tests, e.g. to determine the 1 dB compression point of an amplifier.

See user manual R&S®SMW-K542 Baseband Power Sweep.

## 5.14 Shifting the baseband signal

The R&S SMW200A provides settings to offset the frequency or phase of a baseband signal.

Also, it provides settings to boost the baseband signal.

### 5.14.1 About baseband offsets

The applied baseband frequency and phase offset and path gain affect the signal on the output of the corresponding block, "Baseband" or "BB Input". The shifting of the central frequency of the baseband signal is one of the tasks of the resampler.

#### 5.14.1.1 Impact of the frequency offset

For some applications, it is helpful to shift the baseband signal with a user-defined baseband frequency offset to a different center frequency to improve signal characteristics.

The frequency-offset function shifts the center frequency of the wanted baseband signal. The function also provides a quick way to shift the used frequency band in the RF frequency domain without modifying the RF settings.

See [Section 5.14.3, "Improving signal characteristics by shifting the baseband signal"](#), on page 422.

#### Limitations

The complex I/Q bandwidth of the shifted signal cannot exceed the total available baseband bandwidth. The setting range of the frequency offset is then calculated as follows:

$$-(TotalBasebandBandwidth/2) + f_{use}/2 \leq f_{offset} \leq (TotalBasebandBandwidth/2) - f_{use}/2,$$

where the following applies:

$f_{use}$  is the complex useful bandwidth of the I/Q signal before the offset

$f_{offset}$  is the frequency offset

The [Figure 5-35](#) illustrates the setting range of the frequency offset.

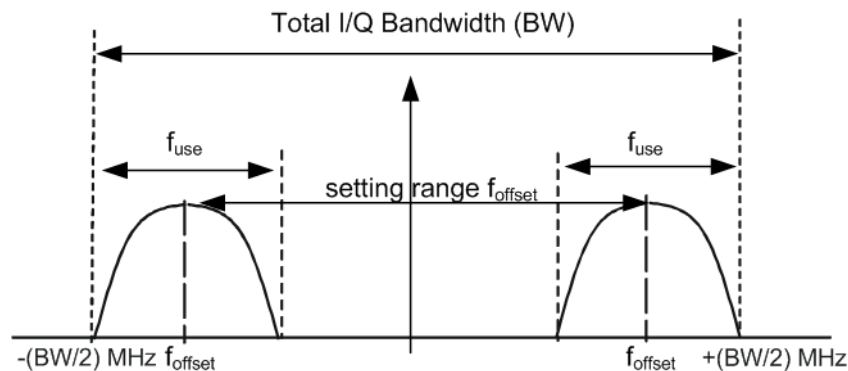

Figure 5-35: Setting range of frequency offset

For more information, refer to the specifications document.

#### Example: To calculate the maximum frequency offset

This example uses the following signal:

- Standard: "Baseband" > "Custom Digital Mod"
- "Set according to Standard" > "WCDMA-3GPP"
- "Symbol Rate" = "3.84 Msym/s" or 3.84 MHz
- "Filter" > "Root Raised Cosine (RRC)"
- "Roll Off Factor" = "0.22"

The complex useful bandwidth of a filtered signal is calculated as follows (see ["Impact of the filter parameters"](#) on page 248):

- $f_{use} = (1 + \text{"Roll Off Factor"}) * \text{"Symbol Rate"}$
- $f_{use} = (1 + 0.22) * 3.84 \text{ MHz} = 4.6848 \text{ MHz}$

For an instrument with a total available I/Q bandwidth of 160 MHz, the valid range of values for the frequency offset is then:

- $-160 \text{ MHz}/2 + 4.6848 \text{ MHz}/2 \leq f_{offset} \leq 160 \text{ MHz}/2 - 4.6848 \text{ MHz}/2$
- $-77.6576 \text{ MHz} \leq f_{offset} \leq 77.6576 \text{ MHz}$

#### To observe the effect of offsetting the frequency

Use the built-in real-time graphical display. Select "System Config" > "Graphics" > "Power Spectrum" and observe the power spectrum of the signal with and without frequency offset.

See ["To set and verify a baseband frequency offset"](#) on page 637.

#### 5.14.1.2 Impact of the phase offset

The "Phase Offset" determines the phase offset between the different baseband signals. A phase offset rotates each point of an I/Q constellation diagram by the specified phase offset.

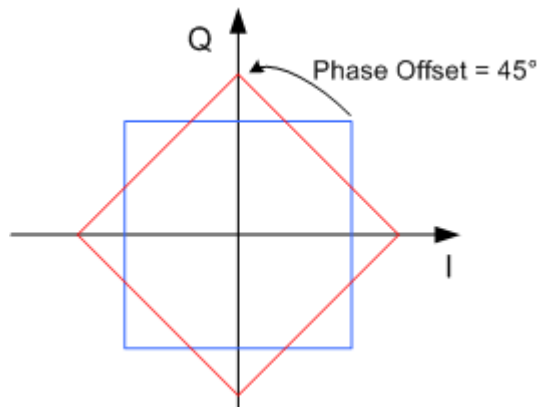

Figure 5-36: I/Q constellation diagram: Effect after offsetting the phase by an angle of 45 °

#### To observe the effect of offsetting the phase

Use the built-in real-time graphical display. Select "System Config" > "Graphics" > "Constellation" and observe that the points on the I/Q constellation diagram are turning counterclockwise.

See [Section 9.1, "Monitoring baseband signal characteristics"](#), on page 622.

#### 5.14.1.3 Impact of the gain

The "Gain" of the different baseband sources determine the relative gain of the associated signals relative to each other.



In "System Config" > "Mode" > "Standard", you can fade the baseband signal and route it at the output of the fading simulator to superimpose the faded signals from the basebands.

The real gain of the superimposed signal is measured at the output of the "Fading" block and set with the fading parameter "Summation Ratio A/B".

See the user manual "Fading Simulator", section "Summation Ratio A/B").

The relative gain set with the parameter "Gain" in the "Baseband" block is ignored.

You can add additional gain to boost the baseband signal.

The real gain in a signal path depends on the following parameters along with the defined baseband gain:

- Signal characteristics, in particular the crest factor
- Number of baseband sources
- Overall RF output level.

#### To observe the effect of changing the gain

To verify and visualize the cumulative baseband signal, use:

- The "System Config" > "Graphics" > "Power Spectrum" view.  
See ["To apply signal path gain and check signal routing"](#) on page 639.

See also [Section 3.3.6, "Visualizing the generated signal"](#), on page 67.

- The "Setup > Baseband Powers Simulation" dialog, see [Section 9.2, "Querying baseband power levels"](#), on page 645.

## 5.14.2 Baseband offset settings

Access:

- ▶ Select "Baseband"/"BB Input" > "Baseband Offsets".

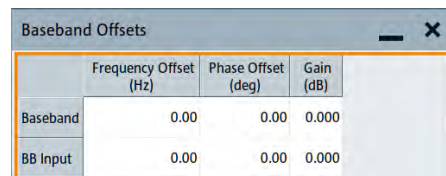

	Frequency Offset (Hz)	Phase Offset (deg)	Gain (dB)
Baseband	0.00	0.00	0.000
BB Input	0.00	0.00	0.000

The "Baseband Offsets" dialog provides settings to offset the frequency or phase of the baseband signal.

Also, you can add a relative gain to the baseband signal.

The block diagram shows an icon  $\Delta f$  on the signal path. This icon indicates an enabled frequency offset.

### Settings:

#### Frequency Offset

Sets the frequency offset of the baseband signal and shifts the useful baseband signal in the center frequency.

Use this function, for example, to shift the baseband signal relative to an AWGN signal.

**Note:** You cannot apply a frequency offset to baseband signals with sample rates of exactly 100 MHz. The R&S SMW200A feeds the digital signal directly into the signal path. It does not route the signal to the resampler that applies the frequency offset.

See also the following sections:

- [Section 5.14.3, "Improving signal characteristics by shifting the baseband signal"](#), on page 422
- [Section 5.14.3, "Improving signal characteristics by shifting the baseband signal"](#), on page 422

Remote command:

`[ :SOURce<hw> ] :BB:F0FFset` on page 1057

`[ :SOURce<hw> ] :BBIN:F0FFset` on page 1057

#### Phase Offset

Sets the phase offset for a baseband signal. This phase offset affects the signal after the "Baseband" block.

Use this parameter, for example, to change the start phase of the baseband signal.

For two-path instruments, sets the phase offset for the selected baseband block compared to the other baseband signals.

See also [Section 5.14.1.2, "Impact of the phase offset"](#), on page 419.

Remote command:

`[ :SOURce<hw> ] :BB:POFFset` on page 1058

`[ :SOURce<hw> ] :BBIN:POFFset` on page 1058

### Gain

Enters the relative gain for the external or internal baseband signal compared with the signals of the other baseband sources, if the signals are added.

The gain affects the signal on the output of the "BB Input" block.

Refer to [Section 5.14.1.3, "Impact of the gain"](#), on page 420 for detailed information.

Remote command:

`[ :SOURce<hw> ] :BB:PGAin` on page 1058

`[ :SOURce<hw> ] :BBIN:PGAin` on page 1058

## 5.14.3 Improving signal characteristics by shifting the baseband signal

Shifting of the generated baseband signal is useful in the following cases:

- You analyze the generated signal with a signal analyzer and the displayed signal spectrum indicates a carrier leakage (a signal drop) at the current RF frequency.

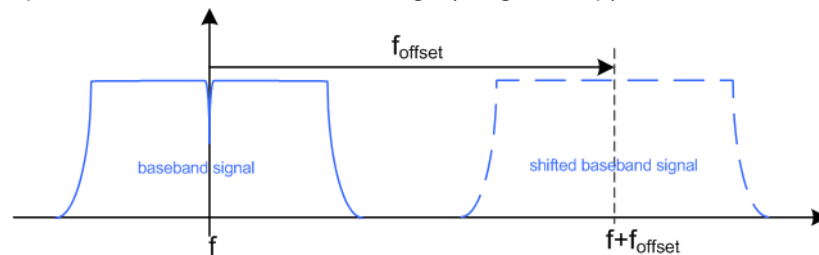

Shifting the baseband signal to a different center frequency can eliminate the carrier leakage problem.

Alternatively, apply an I and/or Q offset and vary the settings until the observed signal drop disappears, see ["To optimize the carrier leakage suppression"](#) on page 457.

- You generate a test signal as a sum of two baseband signals with overlapping spectra. The two signals can originate, for example from internal baseband signals (baseband A and baseband B) or an internal and an externally supplied baseband signal. You route the sum signal to the same RF output with the same RF frequency.

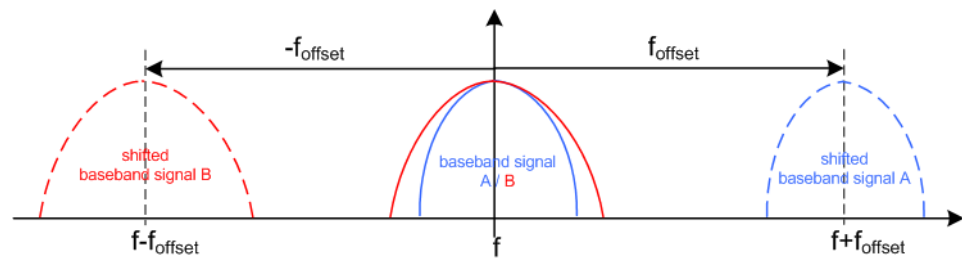

- Shifting one of the basebands allows you to analyze them both
- Shifting both baseband signals with the same frequency offset results in a signal with carrier frequency in the center of the RF bandwidth

In the following examples, we assume that:

- The R&S SMW200A generates a baseband signal
- A spectrum analyzer is connected to the R&S SMW200A, the analyzed is configured and measures the required signal characteristics.

#### To shift the generated baseband signal

1. Select "Baseband" > "Baseband Offsets".
2. To apply an offset to the baseband signal, select for example "Frequency Offset" = "10 MHz".

#### To verify characteristics of the generated signal

- ▶ Use the built-in real-time graphical display.  
See [Section 3.3.6, "Visualizing the generated signal"](#), on page 67.

#### To observe the effect of applied frequency offset and gain

- ▶ Use the built-in real-time graphical display.  
See [Section 3.3.6, "Visualizing the generated signal"](#), on page 67.

## 6 Fading, predistorting and impairing the signal

The test case scenarios in accordance with the specifications often require a not "clean" signal but rather a signal that is impaired or interfered. To fulfill such requirements, the R&S SMW200A is equipped with a fading simulator and noise generator and provides the possibility to impair and predistort the digital I/Q signal.

This section describes the following functions:

• <a href="#">Simulating fading</a> .....	424
• <a href="#">Adding noise to the signal</a> .....	424
• <a href="#">Generating impulsive and phase noise</a> .....	442
• <a href="#">Impairing the signal</a> .....	449
• <a href="#">Frequency response correction</a> .....	457
• <a href="#">Applying digital predistortion</a> .....	457

### 6.1 Simulating fading

A wireless signal transmitted over the air is subject to noise interference and fading. Fading can impair the transmitted signal significantly and hence strongly influence the performance of a communication system. Fading can cause decreased signal-to-noise ratio or can introduce intersymbol interference.

To simulate real-world conditions, the R&S SMW200A is equipped with an integrated real-time fading simulator. With the provided functions, you can simulate repeatable fading conditions for receiver tests.

For a description of the fading simulator, refer to the user manual "Fading Simulator".

### 6.2 Adding noise to the signal

This section introduces the concept of the AWGN generator (Additive White Gaussian Noise). The section also describes the settings for generation of noise, sine wave interferer, and adding noise to the generated signal.

#### 6.2.1 Required options

The equipment layout for generating an AWGN signal includes:

- Option Standard or Wideband Baseband Generator (R&S SMW-B10/-B9) per signal path and
- Option Baseband main module, one/two I/Q paths to RF (R&S SMW-B13/-B13T) or Option Wideband baseband main module two I/Q paths to RF (R&S SMW-B13XT)
- Option Noise Generator (R&S SMW-K62) per signal path



## 6.2.2 About the AWGN generator

Provided the required options are installed, the R&S SMW200A allows you to superimpose noise on the generated signal. The built-in internal noise generator generates an AWGN signal (Additive White Gaussian Noise) with selectable bandwidth and adds it to the digital baseband signal. The main characteristic of this kind of noise signal is the Gaussian distribution of the noise power density and uniform frequency distribution.

### Generation of the AWGN signal

The Gaussian noise is generated with a feedback shift register with subsequent probability transformation. The switching configuration is such that ideal statistical characteristics are achieved:

- I and Q paths are decorrelated from each other.
- Small probabilities are ensured via the crest factor of ~15 dB
- The period of the noise signal is relatively long and depends on the selected system bandwidth.
- Scalable lowpass filters are used to produce a noise level with both a broad dynamic range and a broad bandwidth range.

### AWGN modes

The AWGN generator generates signal in one of the following different modes:

- **"Additive Noise"**: the generated noise signal superimposes the interference-free useful signal



- **"Noise Only"**: a pure noise signal is generated and modulated to the carrier; the connection to the baseband is interrupted.

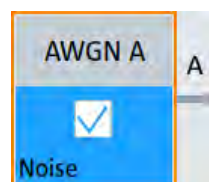
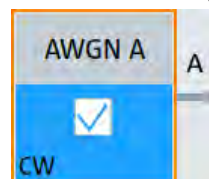

Figure 6-1: Representation of an AWGN > Mode > Noise Only in the block diagram

- **"CW Interferer"**: a sinusoidal signal with an adjustable frequency offset and carrier-to-interferer (C/I) power ratio is added to the baseband signal.



### Signal and noise parameters

The [Figure 6-2](#) illustrates the relation between the signal and noise parameters.

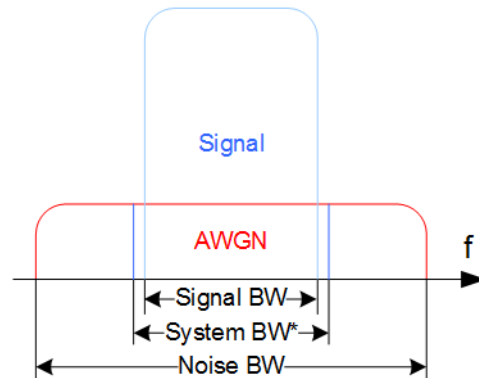

**Figure 6-2: Graphical representation of the relation between system bandwidth and noise bandwidth (Minimum Noise/System BW = 2)**

System BW\* = Occupied BW

The **system bandwidth** is a measure for the transmitted RF bandwidth. The selected value is usually the occupied bandwidth and is therefore a value greater than the pure signal bandwidth.

In the most test cases, the signal and the noise power are not defined directly but with the target signal-to-noise ratio (SNR) or **carrier/noise ratio**.

The **carrier power** is a measure for the *signal without the noise distribution*. This indication corresponds to the "Level" value in the "Status bar" (see [Figure 6-3](#)).

To ensure flat noise within the selected system bandwidth, the **noise bandwidth** has to be larger than the system bandwidth. The minimum noise bandwidth is sometimes part of the specifications and is calculated as follows:

"Noise Bandwidth" = "System Bandwidth" x "Minimum Noise/System Bandwidth Ratio"

Logically, the calculated noise bandwidth does not exceed the total available bandwidth of the instrument.

For more information, refer to the specifications document.

By default, the **noise power** within the system bandwidth is not defined directly but calculated depending on the selected system bandwidth and the desired SNR. The noise power over the noise bandwidth is calculated respectively.

The noise signal is not generated arbitrarily for a particular bandwidth, but instead it is generated in steps. Noise therefore also occurs outside the set system bandwidth, which means that the total measurable noise power usually exceeds the displayed value "Noise Power".

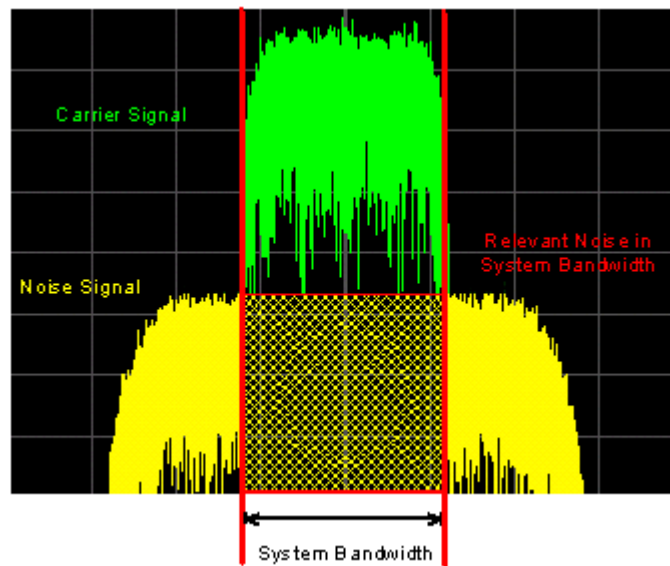

For a correct measurement of the noise power within the system bandwidth, we recommend that you measure the channel power with a signal analyzer.

In the "Additive Noise" mode, the output signal is the *signal with the noise distribution*. Hence, the power level at the RF output corresponds to the **carrier+noise power** (see [Figure 6-3](#)).

The noise power of digitally modulated signal is characterized by the parameter  $E_b/N_0$  indicating the ratio of bit energy to noise power density. The correlation to the SNR is as follows:

$C/N$  or  $S/N = (E_b/N_0) \cdot (f_{bit}/B_{sys})$ , where  $B_{sys}$  is the system bandwidth.

Bit Rate  $f_{bit} = \text{"Symbol Rate"} \cdot \text{Modulation Value}$



#### Where the bit rate value is retrieved from?

The parameter "AWGN > Noise Power / Output Results > Bit Rate" indicates the value used by the C/N or  $E_b/N_0$  calculation. The value is retrieved automatically depending on the configured baseband signal:

- For signals generated by the "Custom Digital Mod", the bit rate is determined by the selected standard (see parameter "Custom Dig Mod > General" > "Symbol Rate" and "Custom Dig Mod > Modulation Type").
- For signals generated in accordance to a digital standard, the bit rate is often a standalone parameter. Some test cases however, for example the 3GPP base station tests (TS 25.141), specify the E/N settings that apply to channel-coded data or block segments. Set the parameter "Bit Rate" to the required value, e.g. the bit rate before or after channel coding.

### Understanding the displayed information

The following example explains the impact of the AWGN settings on the signal and noise parameters.

See [Figure 6-3](#) for an example of an AWGN generation with the following configuration:

- Default "System Configuration"
  - "Mode = Standard"
  - "Signal Routing = A -> A ,B ->B"Perform the following in the first path:
- "Baseband"
  - "Custom Digital Modulation > Set acc. to standard > WCDMA-3GPP"
  - "State > On".
  - "Symbol Rate = 3.840 Msym/s"
- "AWGN"
  - "General > Mode > Additive Noise"
  - "General > Min Noise/System Bandwidth Ratio = 3"
  - "General > State > On"
  - "Noise Power / Output Results > Show Results for Output > RF"
  - "Noise Power / Output Results > Reference Mode > Carrier"
  - "Noise Power / Output Results > Carrier/Noise Ratio = 10 dB"
- "RF > On"

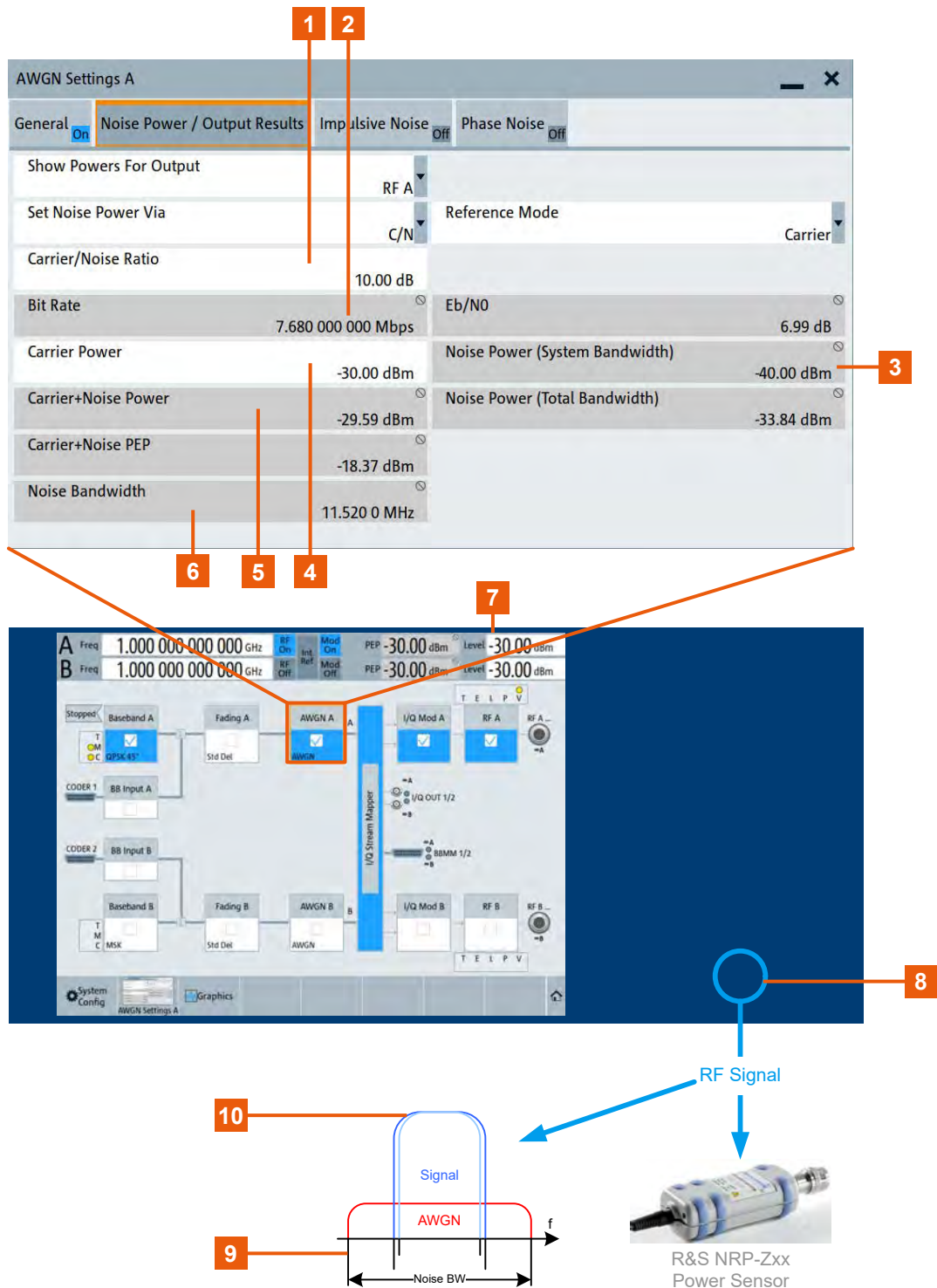

Figure 6-3: AWGN: Understanding the displayed information

- 1 = Bit Rate derived from the selected "Symbol Rate = 3.840 Msym/s"
- 2 = Selected Carrier/Noise Ratio
- 3 = Noise Power calculated from the "Carrier Power" and the "Carrier/Noise Ratio" = -30 dBm - 10 dB = -40 dBm

- 4, 7, 10 = **Carrier Power** = Status bar > Level = -30 dBm  
 5, 8 = **Carrier+Noise Power** = power at the RF A output; i.e. the power a connected power meter would measure  
 6, 9 = **Noise Bandwidth** = **System Bandwidth\*Minimum Noise/System Bandwidth Ratio** = 3.840 MHz\*3 = 11.520 MHz



Use the built-in graphical signal monitoring function of the instrument to display the signal characteristics in real-time, see ["To observe the effect of enabled additive noise \(AWGN\)"](#) on page 643.

### Joint configuration of all streams

In **Advanced mode**, the instrument can generate the signal of one or more streams. In the AWGN, with the parameter **Coupled Mode** you define how this streams are configured; coupled, i.e. the same settings apply to all streams, or independently.

We recommend that you configure the AWGN settings in the default coupled mode. When you disable the coupled mode, the instrument does not apply the current settings to all streams. The settings of the individual streams are in the state they were before the coupled mode was enabled.

If you prefer to configure the streams independently, consider the interdependencies listed in [Table 6-1](#).

**Table 6-1: State settings coupled and individual modes**

	AWGN > Coupled Mode > On	AWGN > Coupled Mode > Off
Effect of the parameters "AWGN > AWGN Settings > General > State" and "AWGN > State"	The states of all streams are coupled; the parameters "AWGN > AWGN Settings > General > State" and "AWGN > State" have the same effect.  Hence, enabling/disabling the AWGN block ("AWGN > On/Off") activates/deactivates all streams.	The parameter "AWGN > AWGN Settings > General > (Stream) State" enables/disables each stream individually.  The "AWGN > State > Off" deactivates all streams.  The "AWGN > State > On" activates all streams for that the "AWGN > AWGN Settings > (Stream) State > On"

### Application fields

Typically, the noise generator is required for the following tests:

- In receiver sensibility tests with predefined SNR of the receiver, see ["To configure the AWGN for receiver sensibility tests"](#) on page 440
- In bit-error or block-error measurements, depending on the set signal-to-noise ratio (SNR)
- Whenever a pure noise signal is required

### 6.2.3 AWGN block



The "AWGN" block provides access to the settings for the **AWGN generator**, see [Section 6.2.4, "AWGN settings"](#), on page 431. The label in the AWGN block indicates the AWGN mode that is activated. The quickest way to activate or deactivate the AWGN generator is the "On/Off" switch in the AWGN block.

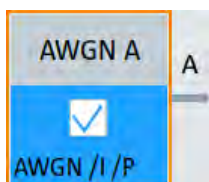

If option R&S SMW-K810 is installed, you can also access **impulsive and phase noise** settings from the AWGN block you also access the settings, see [Section 6.3, "Generating impulsive and phase noise"](#), on page 442. You can activate one or more noise generators. The label in the AWGN block changes to reflect the active noise generators, too. The "On/Off" switch in the AWGN block toggles the state of the noise generator that was previously active.

### 6.2.4 AWGN settings

Access:

1. Option: R&S SMW-B9, enable one of the following:
  - a) "System Config > Fading/Baseband Config > Mode = Standard" with "Signal Outputs = Analog Only".
  - b) "System Config > Fading/Baseband Config > Mode = Advanced".
2. Select "Block Diagram > AWGN".

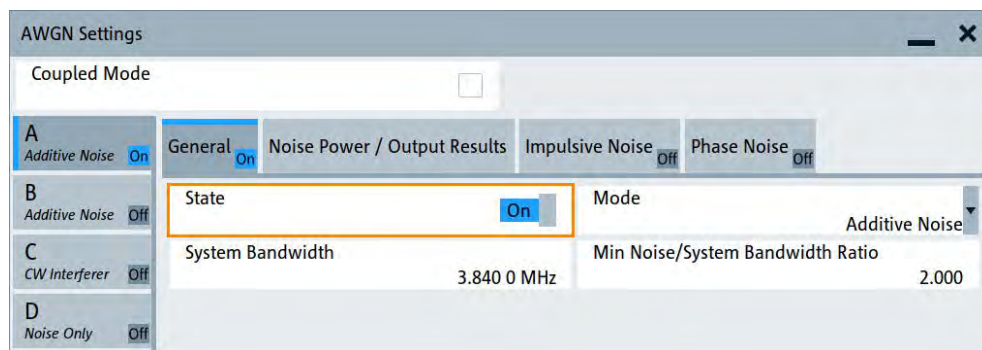
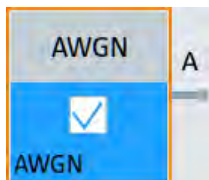

The dialog contains the settings for noise level configuration and CW interfering parameters.

If the instrument is configured to work in **Advanced mode** ("System Configuration > Fading/Baseband Configuration > Mode > Advanced") and **Coupled Mode** is disabled, the dialog consists of more than one side tabs, whereas the number of tabs corresponds to the number of selected **Basebands (Tx Antennas)**. The tab name displays the baseband that the settings are related to and the mode the noise is generated at.

3. To activate the AWGN generator, select "Block Diagram > AWGN > AWGN > General > State > On"

In **Advanced mode**, a dedicated LED indicates the state of each stream.

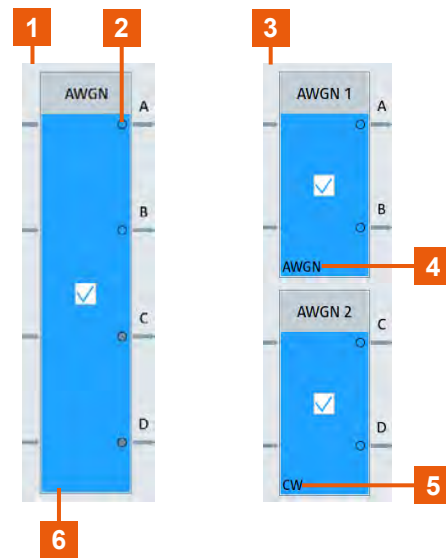

**Figure 6-4: Representation of the AWGN blocks in System Configuration > Advanced Mode"**

- 1 = Example of an 1x4x4 configuration
- 2 = Dedicated LEDs indicate the state of each stream.
- 3 = Example of a 2x2x2 configuration
- 4, 5 = AWGN mode indication: AWGN indicates "AWGN Mode > Additive Noise/Noise Only", CW - "AWGN Mode > CW Interferer".
- 6 = No AWGN mode indication in mixed AWGN streams configuration

The remote commands required to define these settings are described in [Section 14.19.2, "SOURCE:AWGN subsystem"](#), on page 1016.

### Settings:

#### 6.2.4.1 General settings

##### Access:

- ▶ Select "Block Diagram > AWGN".

##### Settings:

State.....	432
Coupled Mode.....	433
Mode.....	433
System Bandwidth.....	433
Minimum Noise/System Bandwidth Ratio.....	434
Center Frequency Offset.....	434
Target CW Frequency Offset.....	434

##### State

Activates/deactivates the generation of an AWGN signal. The interferer (AWGN or CW interferer, depending on the selected mode) is generated after the generator is activated.



Option: R&S SMW-B9, enabled in:

- "System Config > Fading/Baseband Config > Mode = Standard" with "Signal Outputs = Analog Only"
- "System Config > Fading/Baseband Config > Mode = Advanced".

Remote command:

[ :SOURce<hw> ] :AWGN:STATe on page 1020

### Coupled Mode

Couples the configuration of all streams.

**Note:** In the default state of the AWGN, this parameter is enabled. We recommend that you configure the AWGN settings in coupled mode.

When you disable the coupled mode, the instrument does not apply the current settings to all streams. The settings of the individual streams are in the state they were before the coupled mode was enabled.

See also "[Joint configuration of all streams](#)" on page 430.

Remote command:

[ :SOURce<hw> ] :AWGN:CMODE [ :STATe ] on page 1020

### Mode

Activates/deactivates the generation of an AWGN signal. The interferer (AWGN or CW interferer, depending on the selected mode) is generated after the generator is activated.

"Additive Noise"

The AWGN noise signal with selectable system bandwidth is added to the baseband signal.

"Noise Only"

The pure AWGN noise signal with selectable system bandwidth is modulated to the carrier. The connection to the baseband is interrupted.

"CW Interferer"

A sine with a defined frequency offset is added to the baseband signal.

This mode is disabled in "System Configuration" with more than 4 input streams.

Remote command:

[ :SOURce<hw> ] :AWGN:MODE on page 1020

### System Bandwidth

For "Additive Noise" and "Noise Only" modes, sets the RF bandwidth to which the set carrier/noise ratio relates.

Within this frequency range, the signal is superimposed with a noise signal which level corresponds exactly to the set C/N or S/N ratio.

For more information, refer to the description of [Figure 6-2](#).

Remote command:

[ :SOURce<hw> ] :AWGN:BWIDth on page 1020

**Minimum Noise/System Bandwidth Ratio**

For "Additive Noise" and "Noise Only" modes, sets the ratio of minimum noise bandwidth to system bandwidth, as required by some standards.

"Noise Bandwidth" = "System BW" x "Minimum Noise/System BW Ratio"

The parameter [Noise Bandwidth](#) displays the resulting noise bandwidth. Because the noise power density is a constant value, increasing the noise/system bandwidth ratio increases the noise bandwidth.

The calculation of level from the selected C/N or S/N ratio in relation to system bandwidth is not influenced.

Remote command:

[\[:SOURCE<hw>\]:AWGN:BWIDth:RATio](#) on page 1021

**Center Frequency Offset**

Option: R&S SMW-B9

Requires "Mode > Additive Noise/Noise Only".

Defines the frequency offset of the noise signal relative to the carrier center frequency. Use the setting to shift noise signals relative to the output RF signal.

Remote command:

[\[:SOURCE<hw>\]:AWGN:FREQuency:CENTer:OFFSet](#) on page 1025

**Target CW Frequency Offset**

In "CW Interferer" mode, sets the desired frequency of the sine wave.

Remote command:

[\[:SOURCE<hw>\]:AWGN:FREQuency:TARGet](#) on page 1025

### 6.2.4.2 Noise power/output results settings

Access:

- ▶ Select "AWGN > Noise Power/Output Results".

AWGN Settings	
General	Off
Noise Power / Output Results	
Show Powers For Output	RF A
Set Noise Power Via	C/N
Carrier/Noise Ratio	Reference Mode
	Carrier
Carrier/Noise Ratio	10.00 dB
Bit Rate	7.680 000 000 Mbps
Carrier Power	-30.00 dBm
Carrier+Noise Power	-30.00 dBm
Carrier+Noise PEP	-23.98 dBm
Noise Bandwidth	0.0 kHz
E <sub>b</sub> /N <sub>0</sub>	6.99 dB
Noise Power (System Bandwidth)	-40.00 dBm
Noise Power (Total Bandwidth)	-40.00 dBm

The available settings depend on the selected [Mode](#).

#### Settings:

Show Powers For Output.....	435
Set Noise Power Via.....	436
Reference Mode.....	436
Bit Rate.....	436
Carrier/Noise Ratio, Signal/Noise Ratio.....	437
E <sub>b</sub> /N <sub>0</sub> .....	437
Carrier Power, Signal Power.....	437
Noise Power (System Bandwidth), Interferer Power.....	438
Noise Power (Total Bandwidth).....	439
Carrier + Noise Power, Signal + Noise Power (System Bandwidth), Carrier + Interferer Power, Signal + Interferer Power.....	439
Carrier + Noise PEP, Signal + Noise PEP (Total Bandwidth), Carrier + Interferer PEP, Signal + Interferer PEP.....	439
Noise Bandwidth.....	440
Resulting CW Frequency Offset.....	440

#### Show Powers For Output

Sets the output to which the displayed settings are related to.

The available outputs depend on the current signal flow configuration, in particular on the current stream mapping (see [Section 4.4, "System configuration settings"](#), on page 118).

This setting also influences:

- The way the interfering parameters are displayed, e.g. if the SNR value is defined as C/N or as S/N.
- The value units:
  - The values related to the RF outputs are displayed in dBm
  - The values related to the baseband outputs - in dB

**Tip:** For better overview of the power values, use the build-in "Baseband Powers" function whenever you:

- Add baseband signals with different signal bandwidth
- Add streams in the "Stream Mapper".

For a description, see [Section 9.2, "Querying baseband power levels"](#), on page 645.

Remote command:

`[ :SOURce<hw> ] :AWGN:DISP:MODE` on page 1021

### Set Noise Power Via

In "Additive Noise" mode, selects the way the noise power is determined.

The following correlation applies:

"C/N or S/N" =  $(E_b/N_0) * (f_{bit}/B_{sys})$ , where:

- "C/N or S/N" is the carrier/noise ratio
- " $E_b/N_0$ " is the ratio of bit energy to noise power density
- "Bit Rate"  $f_{bit}$  = "Symbol Rate" x Modulation Value
- $B_{sys}$  is the system bandwidth.

See also [Section 6.2.2, "About the AWGN generator"](#), on page 425.

Remote command:

`[ :SOURce<hw> ] :AWGN:POWer:MODE` on page 1022

### Reference Mode

Selects whether the carrier or the noise power is kept constant if the C/N or  $E_b/N_0$  ratio is changed.

In the common case, the instrument keeps the carrier power and adjusts the noise power accordingly. Some test cases however, for example the 3GPP base station tests (TS 25.141), specify explicitly the noise power. These test cases require that the noise power is permanently set as a function of the base station power class, whereas the carrier power is variable.

Remote command:

`[ :SOURce<hw> ] :AWGN:POWer:RMODE` on page 1022

### Bit Rate

In "Additive Noise" mode, indicates the bit rate used for converting C/N or S/N to  $E_b/N_0$ .

**Tip:** For digitally modulated signals, select the bit rate before or after channel coding, as required.

See also [Section 6.2.2, "About the AWGN generator"](#), on page 425.

Remote command:

`[ :SOURce<hw> ] :AWGN:BRATe` on page 1022

**Carrier/Noise Ratio, Signal/Noise Ratio**

In "Additive Noise" and "CW Interferer" mode, sets the carrier/noise, signal/noise or signal/interferer ratio.

Whether a configuration of C/N or S/N is enabled, depend on the selected output [Show Powers For Output](#).

- In "Reference Mode > Carrier": sets the noise power. It does not affect the power of the useful signal, i.e. the carrier power remains constant.  
Thus the power of the carrier + noise signal or the *power of the output signal* changes.
- In "Reference Mode > Noise", sets the *power of the useful signal*, i.e. the carrier power.  
The power of the output signal remains constant.
- The power of the noise signal is derived from the entered C/N or S/N value and displayed with the parameter "Noise Power" in the units of the useful signal.
- The power of the useful signal is displayed with the parameter "Carrier Power" and can also be changed there. This indication corresponds to the "Level" value in the "Status bar".
- The power of the output signal is displayed as "Carrier + Noise Power".

See also [Figure 6-3](#).

Remote command:

[\[:SOURCE<hw>\]:AWGN:CNRatio](#) on page 1022

 **$E_b/N_0$** 

In "Additive Noise" mode, sets the ratio of bit energy to noise power density.

- In "Reference Mode > Carrier": sets the *noise power* and hence the power of the output signal, i.e. the carrier + noise signal.  
It does not affect the power of the useful signal, i.e. the carrier power is kept constant.
- In "Reference Mode > Noise": sets the *power of the useful signal*, i.e. the carrier power.  
The noise power is kept constant.
- The power of the noise signal is derived from the selected  $E_b/N_0$  and displayed with the parameter "Noise Power" in the units of the useful signal.
- The power of the useful signal is displayed with the parameter "Carrier Power".  
This indication corresponds to the "Level" value in the "Status bar".
- The power of the output signal is displayed as "Carrier + Noise Power".

See also [Figure 6-3](#).

Remote command:

[\[:SOURCE<hw>\]:AWGN:ENRatio](#) on page 1023

**Carrier Power, Signal Power**

("Additive Noise" and "CW Interferer")

The name of this parameter depends on the selected output [Show Powers For Output](#).

- In "Reference Mode > Carrier": sets the carrier power. This indication corresponds to the "Level" value in the "Status bar".  
The power of the noise signal is derived from the selected C/N or S/N value and displayed with the parameter "Noise Power" in the units of the useful signal.

- In "Reference Mode > Noise", indicates the carrier power as derived from the entered C/N or S/N value. This indication corresponds to the "Level" value in the "Status bar".

The noise power can be set with the parameter "Noise Power".

**Note:** The peak envelope power (PEP) displayed in the "Status bar" corresponds to the PEP value of the carrier. The parameter "Carrier+Noise (PEP)" indicates the PEP value of the overall signal.

See also [Figure 6-3](#).

Remote command:

`[ :SOURce<hw> ] :AWGN:POWer:CARRier` on page 1023

### Noise Power (System Bandwidth), Interferer Power

Displays the power of the noise signal in the system respectively the total bandwidth in "Noise Only" and "Additive Noise" mode.

- "Noise Only" mode
  - Sets the power of the noise signal. This indication corresponds to the "Level" value in the "Status bar".
- "Additive Noise" mode
  - "Reference Mode > Noise"
    - Sets the power of the noise signal. The power of the carrier is derived from the entered C/N or S/N or Eb/N0 value.
  - "Reference Mode > Carrier"
    - Displays the power of the noise signal in the system bandwidth. The power of the noise signal is derived from the entered C/N or S/N or Eb/N0 value.
    - The carrier power is selected with "Carrier Power"; respectively the signal power is displayed by "Signal Power".
- "CW Interferer" mode
  - "Reference Mode > Noise"
    - Sets the power of the interfering signal. The power of the carrier is derived from the entered C/I value.
  - "Reference Mode > Carrier"
    - Displays the power of the interfering signal. The power of the interfering signal is derived from the entered C/N or S/N value. The carrier power is entered under "Carrier Power".

**Note:** The noise signal is not generated arbitrarily for a particular bandwidth, but instead it is generated in steps. Noise therefore also occurs outside the set system bandwidth. The occurrence means that the total measurable noise power usually exceeds the value displayed here. For correct measurement of the noise power within the system bandwidth, we recommend that you measure the channel power with a signal analyzer.

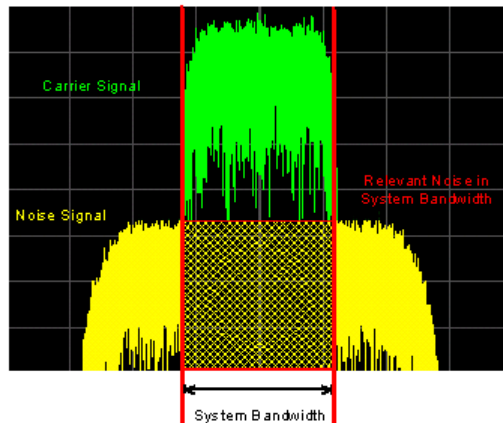

See also [Figure 6-3](#).

Remote command:

`[ :SOURce<hw> ] :AWGN:POWer:NOISe` on page 1023

#### Noise Power (Total Bandwidth)

Displays the power of the noise signal in the total bandwidth in "Noise Only" and "Additive Noise" mode.

See also [Figure 6-3](#).

Remote command:

`[ :SOURce<hw> ] :AWGN:POWer:NOISe:TOTal?` on page 1024

#### Carrier + Noise Power, Signal + Noise Power (System Bandwidth), Carrier + Interferer Power, Signal + Interferer Power

In "Additive Noise" and "CW Interferer" mode, displays the overall power of the noise/interferer signal plus useful signal.

The output selected with the parameter [Show Powers For Output](#) determines:

- The name of this parameter
- The units the overall power is measured in, dBm or dB (full-scale)

See also [Figure 6-3](#).

Remote command:

`[ :SOURce<hw> ] :AWGN:POWer:SUM?` on page 1024

#### Carrier + Noise PEP, Signal + Noise PEP (Total Bandwidth), Carrier + Interferer PEP, Signal + Interferer PEP

In "Additive Noise" and "CW Interferer" mode, displays the peak envelope power (PEP) of the overall signal comprised of noise signal plus useful signal.

The output selected with the parameter [Show Powers For Output](#) determines:

- The name of this parameter
- The units the overall power is measured in, dBm or dB (full-scale)

**Note:** The peak envelope power ("PEP") displayed in the "Status bar" corresponds to the PEP value of the carrier.

Remote command:

`[ :SOURce<hw> ] :AWGN:POWer:SUM:PEP?` on page 1024

**Noise Bandwidth**

For "Additive Noise" and "Noise Only" modes and with activated AWGN generator, indicates the real noise bandwidth.

See also [Figure 6-2](#).

Remote command:

`[ :SOURce<hw> ] :AWGN:BWIDth:NOISe?` on page 1021

**Resulting CW Frequency Offset**

In "CW Interferer" mode, indicates the resulting frequency offset of the sine wave.

Remote command:

`[ :SOURce<hw> ] :AWGN:FREQuency:RESult?` on page 1025

**6.2.5 How to configure the noise generator for receiver tests**

This section shows you how to configure the noise generator for receiver tests, for example the tests specified in the 3GPP test specification TS 36.141, chapter 7.

For the following example, we assume that the R&S SMW200A generates an uplink EUTRA/LTE signal with following characteristics:

- "EUTRA/LTE > Duplexing = FDD", "Link Direction = Uplink"
- "EUTRA/LTE > General Uplink Setting > Channel Bandwidth = 5 MHz" and "Occupied Bandwidth = 4.5 MHz"
- "EUTRA/LTE > Frame Configuration > UE1 > FRC > FRC State = On" and "FRC = TS 36.141: A2-3"
- "EUTRA/LTE > State = On"
- "Status bar > Frequency = 1.95 GHz" and "Level = -69.9 dBm"
- "RF State > On"

**To configure the AWGN for receiver sensibility tests**

We assume that an AWGN interfering signal with the following characteristics is required:

The mean power of the interfering signal is -82.5 dBm/BW and C/N = 12.6 dB.

1. Select "AWGN".
2. Set AWGN general settings:
  - "Mode > Additive Noise"
  - "System Bandwidth = 4.5 MHz"
 

The definition of the interfering signal mean power is dBm/BW, where BW is the system bandwidth. The system bandwidth of the LTE signal is the occupied bandwidth.

See also [Figure 6-2](#).
  - "Min Noise/System Bandwidth Ratio = 1.5"
3. Select "Noise Power/Output Results".
4. Set AWGN noise power settings:



- "Set Noise Power Via = C/N"
- "Reference Mode = Carrier"
- "Carrier/Noise Ratio = 12.6 dB"

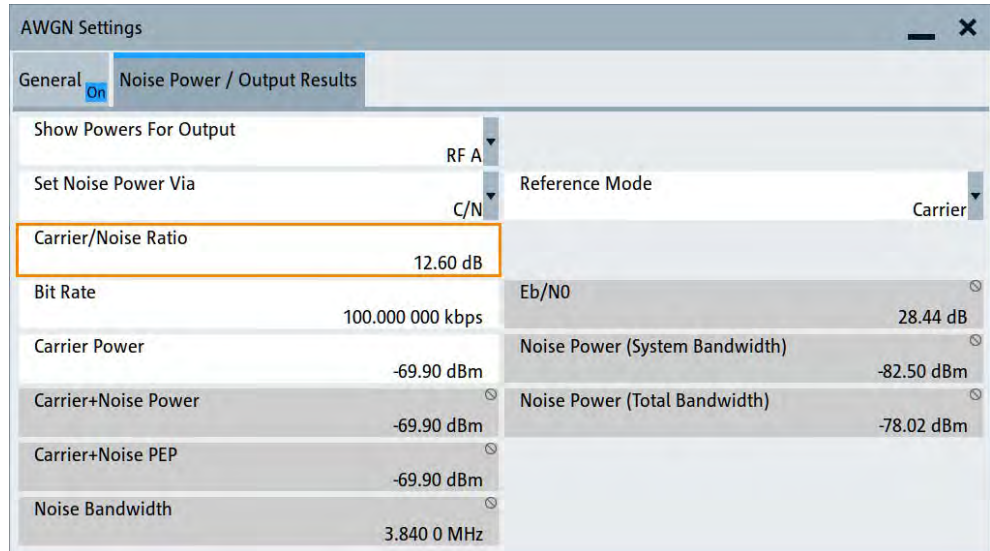

The dialog confirms the required mean power of the interfering signal "Noise Power (System Bandwidth) = -82.5 dBm".

5. Select "AWGN > General > State > On".

### To generate a CW interfering signal

For the following example, we assume that two interfering signals are required, a 5 MHz uplink LTE signal and a CW signal. The signals are transmitted at -52 dBm; the LTE signal at 1.96 GHz and the CW signal 10 MHz below it. Signals with equal (or similar) RF levels and at frequencies spaced within the max. RF bandwidth can be generated by the same path.

To configure the instrument:

1. Enable the required LTE signal:
  - a) Select "EUTRA/LTE > General Uplink Setting > Channel Bandwidth = 5 MHz" and "EUTRA/LTE > State = On"
  - b) Select "Status bar > Frequency = 1.96 GHz" and "Level = -52 dBm"
2. Enable the required interfering signal:
  - a) Select "AWGN > General > Mode > CW Interferer"
  - b) Select "Target CW Frequency Offset = 10 MHz"
  - c) Select "Noise Power/Output Results > Reference Mode = Noise"
  - d) Select "Interferer Power = -52 dB"
  - e) Select "AWGN > General > State > On".
3. Select "RF > State > On"

## 6.3 Generating impulsive and phase noise

Additionally to superimposing an AWGN signal (Additive White Gaussian Noise) with selectable bandwidth on the generated digital baseband signal, you can also generate impulsive noise and phase noise (R&S SMW-K810).

### The R&S SMW-K810 key features

- Pulsed addition of an AWGN signal to the useful signal with settable number of pulses per frame and within settable limits of randomly distributed pulse intervals.
- Addition of phase noise with predefined or user settable phase noise characteristic.

### 6.3.1 Required options

The basic equipment layout for the enhanced noise generation includes the options:

- Standard or wideband baseband generator (R&S SMW-B10/-B9)
- Baseband main module (R&S SMW-B13/-B13T) or wideband baseband main module (R&S SMW-B13XT)
- Option Noise Generator (R&S SMW-K62) per signal path
- Option Enhanced Noise Generation (R&S SMW-K810), per signal path
- Frequency option (e.g. R&S SMW-B1003)

For more information, refer to the specifications document.

### 6.3.2 About the impulsive noise

Impulsive noise can be used to disturb the wanted signal with independent and bursted white Gaussian noise signals.

For characteristics of the digitally generated signal:

See R&S SMW200A user manual, section "Adding Noise to the Signal".

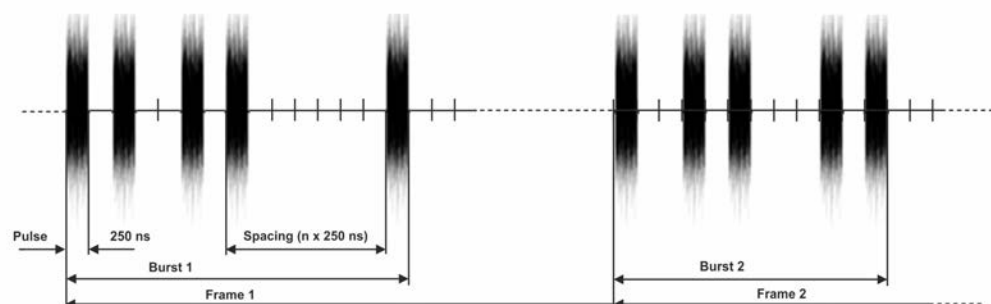

Figure 6-5: Impulsive noise pattern

The R&S SMW200A delivers pulses with a duration of 0.250  $\mu$ s. The amplitudes of the pulses have Gaussian distribution. Their probability distribution function corresponds to

an even distribution within a burst. The burst duration is determined by the number of pulses in a burst ([Pulses per Burst](#)) and the limits for the spacing ([Pulse Spacing Minimum/Pulse Spacing Maximum](#)). The interval between two bursts is determined by the frame duration ([Frame Duration](#)).

### 6.3.3 About the phase noise

The wanted signal of each path can be degraded by a phase noise signal with user-defined characteristics. For this purpose, a Gaussian noise signal is arbitrarily filtered and applied to the phase component of the wanted signal.

You have the following options to generate phase noise:

- Configure the phase noise signal manually, by changing the settings in the "Phase Noise" table.  
The single sideband (SSB) shape profile is defined as a sequence of 5 points, each describing a frequency/phase noise pair.  
See [Section 6.3.5, "Phase noise settings"](#), on page 447.
- Load a user-defined or a predefined single sideband shape profile file.  
See:
  - ["About the single sideband shape profiles"](#) on page 443
  - ["Predefined SSB profiles"](#) on page 444

For any of the two ways, the graph on the left indicates the resulting phase noise.

#### About the single sideband shape profiles

Phase noise profiles describe the single-sided band frequency response of the phase noise. When a file is loaded, the amplitude at 100Hz is held to the previously set value; all other amplitudes are calculated according to the profile. To change the amplitude of the complete profile, set the amplitude at  $f = 100\text{Hz}$ .

Phase noise profile files are files with predefined extension ( $*.fcf$ ) and defined file content.

The file content is as follows:

- Any number of comment lines, each starting with the symbol %
- The keyword `SOS matrix:`
- Two lines, each with the following six coefficients:  
 $b_0 \ b_1 \ b_2 \ a_0 \ a_1 \ a_2$

Where:

- Coefficients are separated by spaces
- Each line corresponds to a second-order section (filter element with two zeros and two poles)

As a result, you obtain the following filter function for each line:

$$\underline{H} = a_0 \cdot \frac{b_0 + b_1 \cdot \underline{z}^{-1} + b_2 \cdot \underline{z}^{-2}}{1 + a_1 \cdot \underline{z}^{-1} + a_2 \cdot \underline{z}^{-2}}$$

The two lines in turn form a cascade connection, which corresponds to multiplying the two functions. The total characteristic of the SSB noise is hence calculated as follows:

$$\text{SSB}(f)_{\text{in}} = N_0 |H_1(z) \cdot H_2(z)|$$

Where:

- $N_0 = -68.3 \text{ dBc/Hz}$
- $z = e^{-j 2\pi f/10 \text{ MHz}} = \cos(2\pi f/10 \text{ MHz}) - j \sin(2\pi f/10 \text{ MHz})$

### Predefined SSB profiles

The following predefined SSB profiles are provided:

- 5G-NR-PT-RS-Set-A.fcf (example, not taken from 3GPP specifications)
- 5G-NR-PT-RS-Set-B.fcf (example, not taken from 3GPP specifications)
- ATSC\_A74.fcf
- crystal1.fcf
- crystal2.fcf
- crystal3.fcf
- crystal4.fcf
- crystal5.fcf
- DVB-S2 A1.fcf
- DVB-S2 A2.fcf
- DVB-S2 D1.fcf
- DVB-S2 P1.fcf
- DVB-S2 P2.fcf
- pll1.fcf
- pll2.fcf

### 6.3.4 Impulsive noise settings

You can generate impulsive noise in the following configurations:

- Option: R&S SMW-B10
  - "System Config > Fading/Baseband Config > Mode = Standard"
  - "System Config > Fading/Baseband Config > Mode = Advanced" with up to 4 streams
- Option: R&S SMW-B9
  - "System Config > Fading/Baseband Config > Mode = Standard" with "Signal Outputs = Analog Only"
  - "System Config > Fading/Baseband Config > Mode = Advanced".

For more information, refer to the specifications document.

Access:

1. Select "AWGN > Config > Impulsive Noise".

2. To start impulsive noise generation with the default settings, select "State > On".

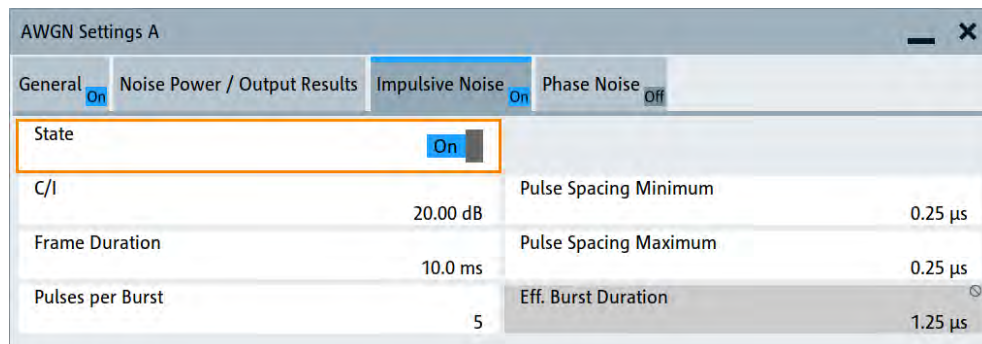

3. Close the dialog and observe the incitation on the block diagram.

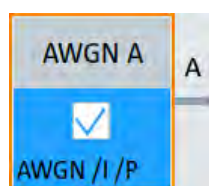

The label in the AWGN block ("Ipls" or "I") changes to reflect that the impulsive noise generation is activated.

The remote commands required to define these settings are described in [Section 14.19.14.2, "Impulsive noise commands"](#), on page 1256.

### Settings:

State.....	445
C/I.....	445
Frame Duration.....	446
Pulses per Burst.....	446
Pulse Spacing Minimum.....	446
Pulse Spacing Maximum.....	446
Eff. Burst Duration.....	446

### State

Enables or disables the impulsive noise generator.

If enabled, an AWGN signal using a pulse generator is applied.

Remote command:

`[ :SOURce<hw> ] :NOISe:IMPulsive [ :STATe ]` on page 1257

### C/I

Specifies the ratio of the wanted signal (C) to the impulsive noise signal (I).

Works like the "AWGN > Noise Power/Output Powers > Carrier/Noise Ratio" parameter but only the noise power of an active pulse is considered. The applied noise power is, however, lower. It corresponds to the number of pulses in a burst and the frame duration.

**Note:** If the AWGN generator and the impulsive noise generator are enabled simultaneously, the noise powers of the two sources are superimposed during the pulses.

Remote command:

`[ :SOURce<hw> ] :NOISe:IMPulsive:CI` on page 1257

### Frame Duration

Sets the time intervals at which the bursts occur.

Remote command:

`[ :SOURce<hw> ] :NOISe:IMPulsive:FRAMe` on page 1257

### Pulses per Burst

Sets the number of noise pulses per burst, where the maximum number of pulses is calculated as `Frame Duration/0.25 μs`.

Remote command:

`[ :SOURce<hw> ] :NOISe:IMPulsive:PULSe` on page 1257

### Pulse Spacing Minimum

If more than 1 pulse per burst is enabled (`Pulses per Burst > 1`), this parameter sets the minimum spacing between 2 pulses within a burst.

If `Pulse Spacing Minimum = Pulse Spacing Maximum = 250 ns`, the pulses directly follow each other. You can set spacing with a resolution of 250 ns.

The minimum burst length that can be obtained is therefore as follows:

$$\text{BurstLength}_{\min} = \text{Pulse Spacing Minimum} * \text{Pulses per Burst} * 250 \text{ ns}$$

Remote command:

`[ :SOURce<hw> ] :NOISe:IMPulsive:MINSpace` on page 1258

### Pulse Spacing Maximum

If more than 1 pulse per burst is enabled (`Pulses per Burst > 1`), this parameter sets the maximum spacing between 2 pulses within a burst.

The max pulse spacing depends on the number of pulses per burst and is calculated as follows:

$$\text{Pulse Spacing Maximum} \leq \text{Frame Duration}/(\text{Pulses per Burst} - 1)$$

Thus, a burst can maximally take the length of a frame.

The maximum burst length that can be obtained is therefore as follows:

$$\text{BurstLength}_{\max} = \text{Pulse Spacing Maximum} * \text{Pulses per Burst} * 250 \text{ ns}$$

Remote command:

`[ :SOURce<hw> ] :NOISe:IMPulsive:MAXSpace` on page 1258

### Eff. Burst Duration

Displays the time during which the noise generator is active in a frame. The duration is the product of the number of pulses per burst and the pulse duration of 250 ns. An equivalent  $C/N_e$  can thus be calculated as follows:

$$C/N_e = C/I * (\text{Eff. Burst Duration}/\text{Frame Duration})$$

Remote command:

`[ :SOURce<hw> ] :NOISe:IMPulsive[:BURSt]:DURation?` on page 1258

### 6.3.5 Phase noise settings

You can generate impulsive noise in the following configurations:

- Option: R&S SMW-B10  
"System Config > Fading/Baseband Config > Mode = Standard"
- Option: R&S SMW-B9
  - "System Config > Fading/Baseband Config > Mode = Standard" with "Signal Outputs = Analog Only"
  - "System Config > Fading/Baseband Config > Mode = Advanced".

For more information, refer to the specifications document.

Access:

1. Select "AWGN > Config > Phase Noise".
2. Select "Phase Noise > State > On".
3. To use one of the predefined single-sideband shape profile, select "Load Profile > Predefined Files".  
For description of the file format, see ["About the single sideband shape profiles"](#) on page 443.
4. In the "Phase Noise" table, set the phase noise characteristics.
5. Select "Save Profile".  
Opens the standard "Save" dialog.
6. Select "File Name", enter the name of file and select "Save".  
The generated file is saved as \*.fcf file.

For description of the file format, see ["About the single sideband shape profiles"](#) on page 443.

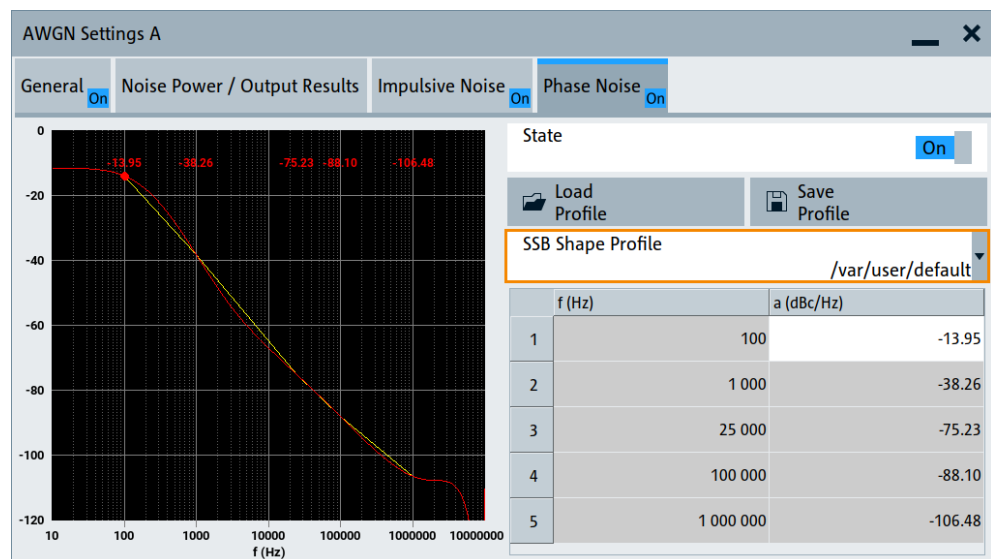

The graph on the left displays two color-coded curves:

- Yellow: the current profile, as set with the frequency/phase values.
- Red: the calculated filter shape incl. the amplitude values at the frequency points.

Close the dialog and observe the incitation on the block diagram.

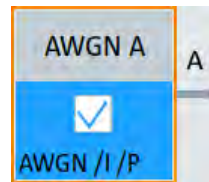

The label in the AWGN block ("Phase" or "P") changes to reflect that the phase noise generation is activated.

The remote commands required to define these settings are described in [Section 14.19.14.3, "Phase noise commands"](#), on page 1258.

#### Settings:

State.....	448
Load Profile, Save Profile.....	448
SSB Shape Profile.....	449
Phase Noise Table.....	449

#### State

Enables or disables the phase noise generator.

If enabled, the null phase angle of the carrier is varied. A noise component with a defined frequency response is added.

Remote command:

`[ :SOURce<hw> ] :NOISe:PHASnoise [ :STATe ]` on page 1258

#### Load Profile, Save Profile

Opens the standard "File Select" dialog with standard file handling functions.

The single-sideband (SSB) spectrum of the signal carrier or, for multicarrier methods, of all single carriers follows the filter curve characteristics of the profile file.

**Note:** If the generation of the profile fails, as it happens for some wanted signal shapes, we recommend that you measure the generated phase noise to ensure that it is equal to the expected phase noise.

For description of the file format, see ["About the single sideband shape profiles"](#) on page 443.

Remote command:

`[ :SOURce<hw> ] :NOISe:PHASnoise:SHAPE:STORe` on page 1259

`[ :SOURce<hw> ] :NOISe:PHASnoise:SHAPE:SELeCt` on page 1259

`[ :SOURce<hw> ] :NOISe:PHASnoise:SHAPE:PREDeFined:CATALog?`  
on page 1259



**SSB Shape Profile**

Indicates the name of the currently used single-sideband (SSB) profile file.

"SSB Shape Profile = User" indicates that no profile is loaded.

**Phase Noise Table**

Defines a single-sideband (SSB) shape profile.

The shape profile is defined as a sequence of 5 points, each describing a frequency/phase noise pair.

The graph on the left displays two color-coded curves:

- Yellow: the current profile, as set with the frequency/phase values.
- Red: the calculated filter shape incl. the amplitude values at the frequency points.

If the values are extracted from a file, you can change the amplitude value for the first point only. The values of the remaining four points are calculated automatically as sum of the value defined in the profile and the delta used for the first point.

Remote command:

[\[:SOURce<hw>\]:NOISe:PHASenoise:LEVel<ch>](#) on page 1259

[\[:SOURce<hw>\]:NOISe:PHASenoise:FREQuency<ch>](#) on page 1260

## 6.4 Impairing the signal

In the R&S SMW200A, *analog and digital linear impairments* such as I/Q imbalance and quadrature error can be added to the generated signal.

The instrument can also simulate the effect of nonlinear memoryless effects like AM/AM and AM/PM conversion.

See the user manual R&S SMW-K540, R&S SMW-K541 Envelope Tracking and AM/AM, AM/PM Predistortion.

### 6.4.1 Required options

The equipment layout for impairing I/Q signals includes the following:

- Option Standard or Wideband Baseband Generator (R&S SMW-B10/-B9) per signal path
- Option Baseband main module, one or two I/Q paths to RF (R&S SMW-B13/-B13T) or  
Option Wideband baseband main module two I/Q paths to RF (R&S SMW-B13XT)

### 6.4.2 About the linear I/Q impairments

I/Q signal impairments are well-defined arithmetic modifications of the data. Every data sample is modified in the same way.

### About adding linear impairments

Adding linear impairments to the data stream is provided for the following purpose:

- To simulate frequent sources of distortions in a real signal processing chain as, it is required for tests with dirty transmitter conditions (receiver tests)
- To compensate the faults of the I/Q demodulator in the receiver

### Key features

The R&S SMW200A offers functions to impair an internal I/Q signal or external I/Q signal linearly.

These functions feature the following:

- Impair I/Q samples for each I/Q stream.
- Add impairments to an analog I/Q input signal.  
The instrument adds these impairments before the I/Q samples are passed to the I/Q modulator.
- Impair analog and digital I/Q signals twice.  
If you apply both impairments, they superimpose each other at the impaired signal.

### Related step-by-step instructions

For adding impairments to I/Q samples, see [Section 6.4.4, "Optimizing carrier leakage and sideband suppression"](#), on page 456.

For correcting impairments of I/Q samples at the I/Q modulator, see ["To correct systematic I/Q modulation errors"](#) on page 461.

### Settings:

- [Gain and gain imbalance](#)..... 450
- [I and Q offset](#).....451
- [Quadrature offset](#)..... 452

#### 6.4.2.1 Gain and gain imbalance

An I/Q gain is a multiplication of all I/Q amplitudes by a common factor. The effect is equivalent to two identical I and Q gain factors. The effect of an increased gain factor in the I/Q constellation diagram is shown on [Figure 6-6](#).

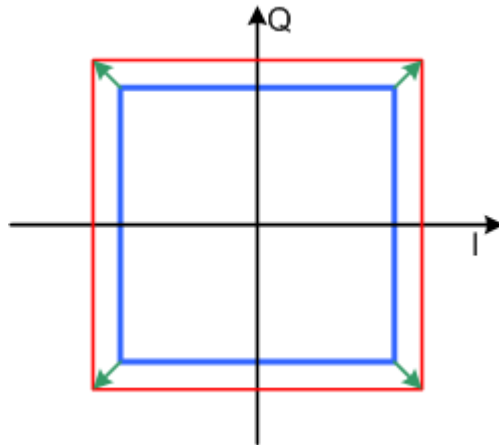

*Figure 6-6: Effect of an increased amplitude in the I/Q constellation diagram*

An I gain multiplies the I amplitudes by a factor, leaving the Q amplitudes unchanged. A Q gain has the opposite effect. Different I and Q gain factors result in an I/Q imbalance, which is due to different gains of the amplifiers in the I and Q channels of the I/Q modulator. The effect of a positive and negative gain imbalance is shown on [Figure 6-7](#).

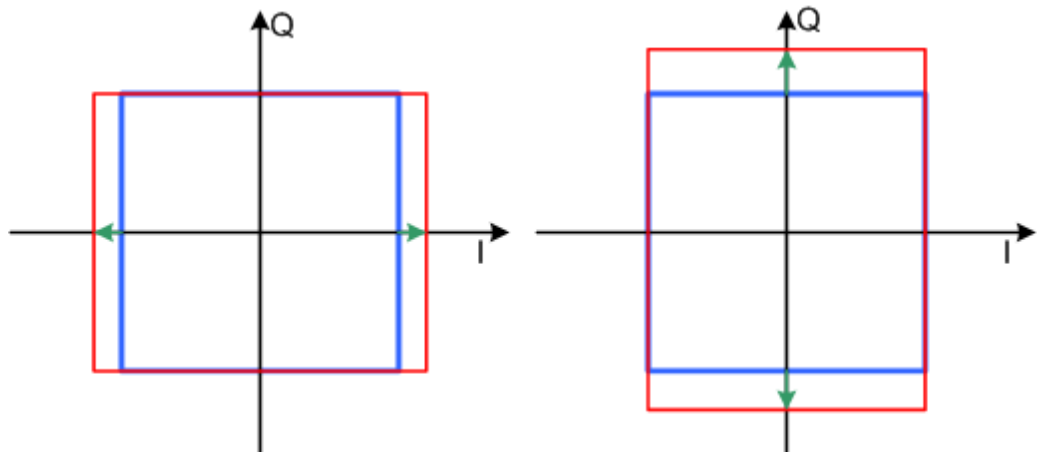

*Figure 6-7: Negative gain imbalance (left) and positive gain imbalance (right) in the I/Q constellation diagram*

#### 6.4.2.2 I and Q offset

An I offset adds a constant value to all I amplitudes, leaving the Q amplitudes unchanged. A Q offset has the opposite effect. A combination of I and Q values results in an I/Q offset, which is due to carrier feedthrough in the I/Q modulator. Possible reasons are interfering signals at the RF carrier frequency, e.g. an unsuppressed RF carrier subchannel. The effect of a positive I and Q offset in the I/Q constellation diagram is shown on [Figure 6-8](#).

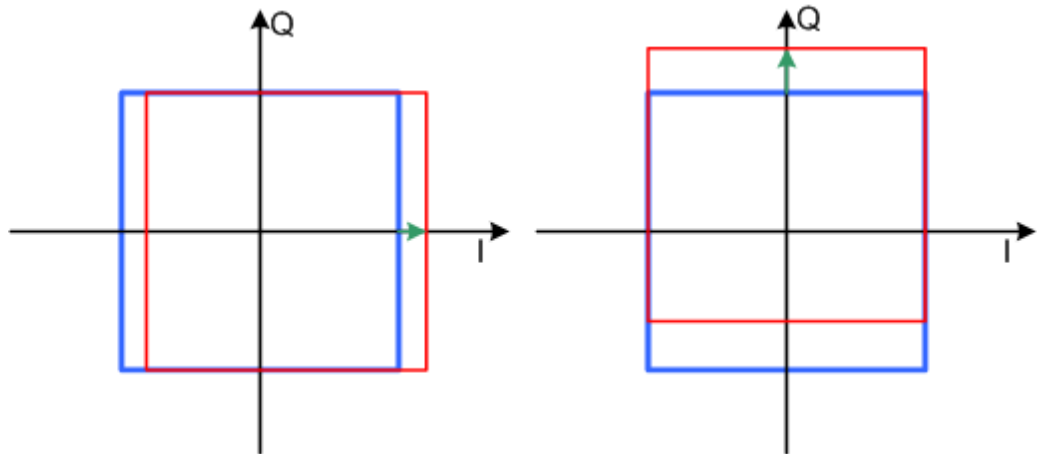

Figure 6-8: I offset (left) and Q offset (right) in the I/Q constellation diagram

### 6.4.2.3 Quadrature offset

Changes the phase angle between the I and the Q vectors from the ideal 90 degrees, while the amplitudes are maintained. A positive quadrature offset results in a phase angle greater than 90 degrees. The effect of a positive quadrature offset in the I/Q constellation diagram is shown on Figure 6-9.

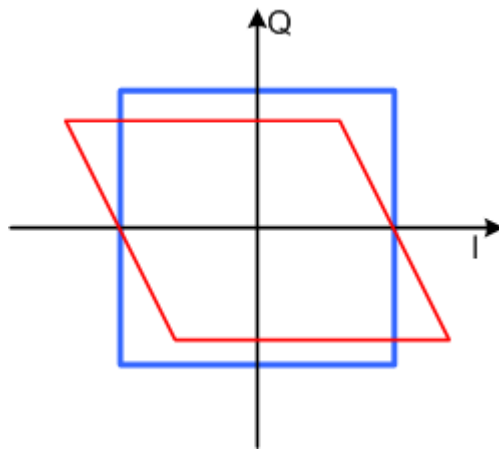

Figure 6-9: Positive quadrature offset in the I/Q constellation diagram

## 6.4.3 Analog and digital impairments settings

You can add digital impairments to each internal generated I/Q stream and analog impairments to internal generated or externally supplied analog I/Q signals.

See also [Section 6.4.2, "About the linear I/Q impairments"](#), on page 449.

### Accessing analog impairments settings

- ▶ Select "I/Q Mod" > "I/Q Analog Impairments".

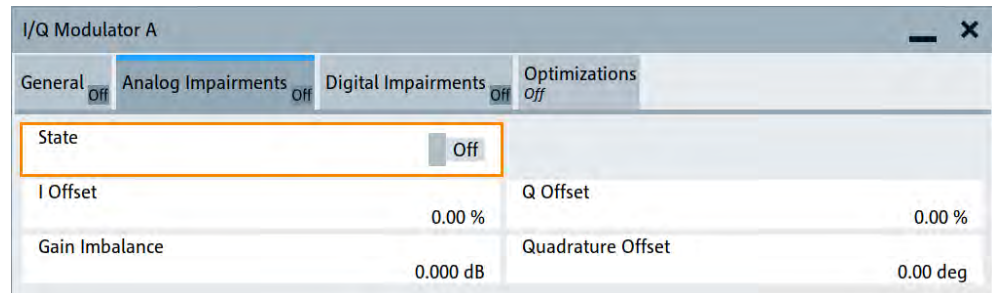

The dialog provides settings to configure I/Q analog impairments, like carrier leakage, imbalance and quadrature offset.

### Accessing digital impairments settings

1. Select "I/Q Mod" > "I/Q Digital Impairments" for digital impairing I/Q signals at the I/Q modulator to the RF output.
2. To add digital impairments to the other I/Q streams, access these settings as follows:
  - For analog I/Q outputs, select "I/Q Analog" > "I/Q Digital Impairments".
  - For digital I/Q outputs, select "I/Q Digital" > "I/Q Digital Impairments".

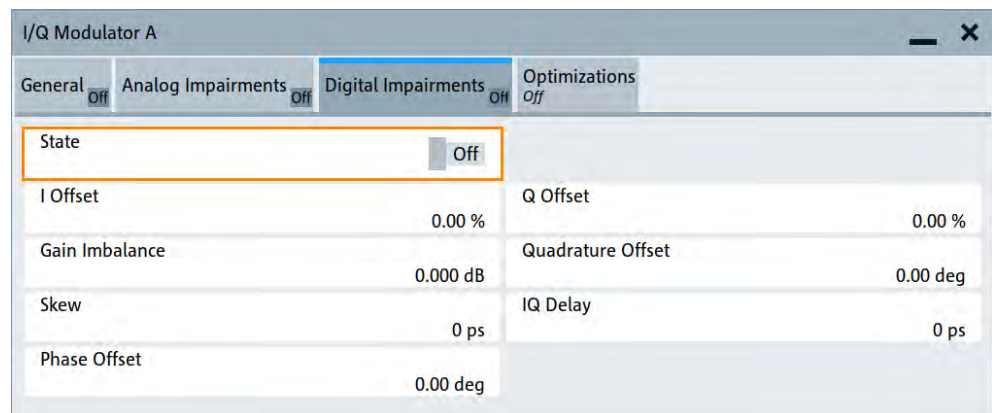

The dialog provides settings to configure I/Q digital impairments, like carrier leakage, imbalance, quadrature offset and I/Q delays.

If you connect an R&S SGT to one of the digital interfaces, the R&S SMW200A applies digital impairments at this R&S SGT. See also [Figure 4-17](#).

The remote commands required to define these settings are described in:

- [Section 14.19.5.5, "SOURce:BB:IMPairment subsystem"](#), on page 1169.
- [Section 14.19.10, "SOURce:IQ subsystem"](#), on page 1209.

The instrument can also simulate nonlinear effects like AM/AM and AM/PM conversion.

See the R&S SMW200A Envelope Tracking and AM/AM, AM/PM Predistortion user manual.

### Settings:

State.....	454
I Offset/Q Offset.....	454
Gain Imbalance.....	454
Quadrature Offset.....	455
Skew.....	455
IQ Delay.....	456
Phase Offset.....	456

### State

Enables adding impairments to the I/Q signal.

If enabled, the R&S SMW200A applies the settings for I/Q offset, gain imbalance and quadrature offset.

Remote command:

For analog impairments: `[ :SOURce<hw> ] :IQ:IMPairment [ :STATe ]` on page 1172

For digital impairments:

`[ :SOURce ] :BB:IMPairment:BBMM<ch>:STATe` on page 1172

`[ :SOURce ] :BB:IMPairment:FADer<ch>:STATe` on page 1173

`[ :SOURce ] :BB:IMPairment:IQOutput<ch>:STATe` on page 1173

`[ :SOURce ] :BB:IMPairment:RF<ch>:STATe` on page 1173

### I Offset/Q Offset

Sets a carrier offset (in percent) of the amplitudes (scaled to the peak envelope power (PEP)) for the I and/or Q signal component. An ideal I/Q modulator suppresses the carrier offset completely (offset = 0 percent).

For more information, see the following sections:

- [Section 6.4.2.2, "I and Q offset"](#), on page 451
- ["To optimize the carrier leakage suppression"](#) on page 457

Remote command:

For analog impairments:

`[ :SOURce<hw> ] :IQ:IMPairment:LEAKage:I` on page 1171

`[ :SOURce<hw> ] :IQ:IMPairment:LEAKage:Q` on page 1171

For digital impairments:

`[ :SOURce ] :BB:IMPairment:BBMM<ch>:LEAKage:I` on page 1171

`[ :SOURce ] :BB:IMPairment:BBMM<ch>:LEAKage:Q` on page 1171

`[ :SOURce ] :BB:IMPairment:FADer<ch>:LEAKage:I` on page 1171

`[ :SOURce ] :BB:IMPairment:FADer<ch>:LEAKage:Q` on page 1171

`[ :SOURce ] :BB:IMPairment:IQOutput<ch>:LEAKage:I` on page 1171

`[ :SOURce ] :BB:IMPairment:IQOutput<ch>:LEAKage:Q` on page 1171

`[ :SOURce ] :BB:IMPairment:RF<ch>:LEAKage:I` on page 1171

`[ :SOURce ] :BB:IMPairment:RF<ch>:LEAKage:Q` on page 1171

### Gain Imbalance

Sets the imbalance of the I and Q vector.

The entry is made in dB (default) or %, where 1 dB offset is roughly 12% according to the following:

$$\text{Imbalance [dB]} = 20 \log ( | \text{GainQ} | / | \text{GainI} | )$$

Positive values mean that the Q vector is amplified more than the I vector by the corresponding percentage. Negative values have the opposite effect.

For more information, see the following sections:

- [Section 6.4.2.1, "Gain and gain imbalance"](#), on page 450
- ["To optimize sideband suppression"](#) on page 456

Remote command:

For analog impairments: `[ :SOURce<hw> ] :IQ:IMPairment:IQRatio[:MAGNitude]` on page 1171

For digital impairments:

`[ :SOURce ] :BB:IMPairment:BBMM<ch>:IQRatio[:MAGNitude]` on page 1171

`[ :SOURce ] :BB:IMPairment:FADer<ch>:IQRatio[:MAGNitude]` on page 1171

`[ :SOURce ] :BB:IMPairment:IQOutput<ch>:IQRatio[:MAGNitude]`

on page 1171

`[ :SOURce ] :BB:IMPairment:RF<ch>:IQRatio[:MAGNitude]` on page 1171

### Quadrature Offset

Sets the quadrature offset.

For more information, see the following sections:

- [Section 6.4.2.3, "Quadrature offset"](#), on page 452
- ["To optimize sideband suppression"](#) on page 456

Remote command:

For analog impairments: `[ :SOURce<hw> ] :IQ:IMPairment:QUADrature[:ANGLE]` on page 1172

For digital impairments:

`[ :SOURce ] :BB:IMPairment:BBMM<ch>:QUADrature[:ANGLE]` on page 1172

`[ :SOURce ] :BB:IMPairment:FADer<ch>:QUADrature[:ANGLE]` on page 1172

`[ :SOURce ] :BB:IMPairment:IQOutput<ch>:QUADrature[:ANGLE]`

on page 1172

`[ :SOURce ] :BB:IMPairment:RF<ch>:QUADrature[:ANGLE]` on page 1172

### Skew

Sets or displays the delay between the Q vector and the I vector of the corresponding stream.

Setting this delay is possible for I/Q samples in the I/Q modulator ("I/Q Mod" > "I/Q Digital Impairments") and at the I/Q analog output interfaces ("I/Q Analog" > "I/Q Digital Impairments" dialog).

You cannot set a delay at the I/Q digital output interfaces.

See [Figure 4-17](#).

Remote command:

`[ :SOURce ] :BB:IMPairment:BBMM<ch>:SKEW` on page 1172

`[ :SOURce ] :BB:IMPairment:FADer<ch>:SKEW` on page 1172

`[ :SOURce ] :BB:IMPairment:IQOutput<ch>:SKEW` on page 1172

`[ :SOURce ] :BB:IMPairment:RF<ch>:SKEW` on page 1172

**IQ Delay**

Sets or displays the time delay of both I and Q vectors relative to the selected trigger and marker. A positive value means that the I and Q vectors delay relative to the marker or trigger. A negative delay implies the other way around.

Setting this time delay is possible for I/Q samples in the I/Q modulator ("I/Q Mod" > "I/Q Digital Impairments") and at the I/Q analog output interfaces ("I/Q Analog" > "I/Q Digital Impairments").

You cannot set a delay at the I/Q digital output interfaces.

See also [Section 10.3.1, "Connecting multiple instruments in primary-secondary instrument mode"](#), on page 664.

Remote command:

`[ :SOURce ] :BB :IMPairment :BBMM<ch> :DELay` on page 1170

`[ :SOURce ] :BB :IMPairment :FADer<ch> :DELay` on page 1170

`[ :SOURce ] :BB :IMPairment :IQOutput<ch> :DELay` on page 1170

`[ :SOURce ] :BB :IMPairment :RF<ch> :DELay` on page 1170

**Phase Offset**

Adds a phase offset after the stream mapper.

You can shift the signal phase at the different stages in the signal generation flow:

- For "Baseband Offsets" > "Phase Offset", see ["Phase Offset"](#) on page 421.
- For "I/Q Stream Mapper" > "Phase Offset", see ["Phase Offset"](#) on page 128.

Remote command:

`[ :SOURce ] :BB :IMPairment :BBMM<ch> :POFFset` on page 1173

`[ :SOURce ] :BB :IMPairment :FADer<ch> :POFFset` on page 1173

`[ :SOURce ] :BB :IMPairment :IQOutput<ch> :POFFset` on page 1173

`[ :SOURce ] :BB :IMPairment :RF<ch> :POFFset` on page 1173

**6.4.4 Optimizing carrier leakage and sideband suppression**

Applying linear I/Q impairments helps to improve signal quality in the following cases:

- To suppress a carrier leakage at the current RF frequency
- To improve the attenuation of the unwanted sidebands

In the following examples, we assume that:

- The R&S SMW200A generates a baseband signal
- A spectrum analyzer is connected to the R&S SMW200A, the analyzer is configured, and measures the required signal characteristics.

**To optimize sideband suppression**

For a given baseband signal, perform the following iterative steps:

1. In the block diagram, select "I/Q Mod" > "I/Q Digital Impairments".
2. Set the values of the parameters "Gain Imbalance" and "Quadrature Offset" to adjust the relative amplitude and phase relationship of the baseband signal.



3. Select "State" > "On".
4. On a connected signal analyzer, monitor the power spectrum.
5. Vary the values of the parameters "Gain Imbalance" and "Quadrature Offset" until the maximal sideband suppression is achieved.

#### To optimize the carrier leakage suppression

For a given baseband signal, perform the following iterative steps:

1. In the block diagram, select "I/Q Mod" > "I/Q Digital Impairments".
2. Set the parameters "I Offset" and "Q Offset".
3. Select "State" > "On".
4. On a connected signal analyzer, monitor the power spectrum.
5. Vary the I/Q offset until the maximal carrier leakage suppression is achieved.

Adjusting the I and Q offsets is one of the possible ways to control carrier leakage.

See also [Section 5.14.3, "Improving signal characteristics by shifting the baseband signal"](#), on page 422.

## 6.5 Frequency response correction

Frequency response correction is a method, used to compensate the frequency response influence of the test setup, for example of the cables, power combiners, switches or mixers. In the R&S SMW200A, you can load user-defined scattering parameters (S-parameters) files and frequency response files and pre-process the internally generated baseband signal with them.

See the user manual "R&S SMW-K544 User-Defined Frequency Response Correction".

## 6.6 Applying digital predistortion

Digital predistortion (DPD) is one of the methods, used to improve the efficiency of RF power amplifiers. In the R&S SMW200A, the generated digital signal can be deliberately AM/AM and AM/PM predistorted.

See the user manual R&S SMW-K540, R&S SMW-K541 Envelope Tracking and AM/AM, AM/PM Predistortion.

## 7 Applying I/Q vector modulation

The R&S SMW200A offers I/Q modulation with an external analog I/Q signals, external digital signals, and the internally generated digital signal.

For a description on applying digital impairments and applying nonlinear effects, see the following sections:

- [Section 6.4, "Impairing the signal"](#), on page 449
- [Section 7.4.2, "Optimizations settings"](#), on page 471

See the user manual R&S SMW-K540, R&S SMW-K541 Envelope Tracking and AM/AM, AM/PM Predistortion.

See the user manual "R&S SMW-K544 User-Defined Frequency Response Correction".

- [Required options](#).....458
- [About the I/Q modulator](#).....458
- [Optimizing I/Q modulation performance](#).....460
- [I/Q modulator settings](#).....466

### 7.1 Required options

The equipment layout for I/Q modulation includes:

- Frequency option (e.g. R&S SMW-B1003)  
Sufficient for I/Q modulation with an external analog signal
- Option standard or Wideband Baseband Generator (R&S SMW-B10/-B9) per signal path and
  - Option Baseband main module, one/two I/Q paths to RF (R&S SMW-B13/-B13T)  
Sufficient for I/Q modulation with internal and external digital signal.
  - Or option wideband baseband main module with two I/Q paths to RF (R&S SMW-B13XT)  
(I/Q modulation with internal digital signal)
- Option differential I/Q Inputs (R&S SMW-K739), for RF path A  
Required for I/Q modulation with an external differential analog signal
- Optional option RF linearization (R&S SMW-K575) per signal path  
Required for optimized wideband I/Q modulation with a linearized RF output signal.

### 7.2 About the I/Q modulator

The R&S SMW200A offers I/Q modulation with the internally generated digital signal, the external digital signals (when separately processed), and an external analog I/Q signal. The maximum available RF bandwidth of an externally applied wideband analog signal is higher than the bandwidths of the internal or external digital signal.

For more information, refer to the specifications document.

### 7.2.1 Input signals of the I/Q modulator

The table [Table 7-1](#) provides an overview of the possible input signals and input connectors. Any of the specified input signals is processed by the I/Q modulator and output at the RF output.

The "IQ Stream Mapper" defines the signal routing of the streams to the output connector. For detailed information, see [Section 4.3, "Overview of the signals and interfaces"](#), on page 108 and [Section 4.4.2, "I/Q stream mapper settings"](#), on page 127.

**Table 7-1: Physical input signals of the I/Q modulator**

Input signal	Input connector	GUI element
Internal digital	-	"I/Q Mod" > "I/Q Modulator Input" > "Internal Baseband" and "Baseband" > "On"
External digital	CODER	"I/Q Mod" > "I/Q Modulator Input" > "Internal Baseband" and "BB Input" > "On"
External analog wideband	I/Q	"I/Q Mod" > "I/Q Modulator Input" > "Analog Wideband I/Q Input"
External differential analog (in the first signal path)	I/Q Bar	"I/Q Mod" > "I/Q Modulator Input" > "Differential Analog I/Q Input"

#### Restrictions to analog I/Q input signals

Analog I/Q input signals are directly applied to the analog I/Q modulation circuit, and are not routed through the baseband section of the R&S SMW200A.

For I/Q modulation with an analog I/Q input signal, you cannot use the following functions or input signals simultaneously:

- Amplitude modulation (AM) of the modulated signal at the RF signal block
- The internal digital baseband signal including digital modulation, ARB, multicarrier CW and the average white Gaussian noise generator (AWGN).
- An external digital input signal.

### 7.2.2 About I/Q modulation optimizations

Option R&S SMW-K575 allows you to optimize the I/Q modulation with internal calibration data by applying an automatic AM/AM predistortion and AM/PM predistortion to the RF chain of the instrument.

Option R&S SMW-K541 allows you to optimize the I/Q modulation manually by measuring the AM/AM predistortion for the current RF settings. For optimization, the option supplies the mode "Linearize RF" > "Manual".

**Installing option R&S SMW-K575**

New R&S SMW200A instruments are shipped with the option R&S SMW-K575 and the instrument has calibration data available. If calibration data is missing, contact Rohde & Schwarz.

If you already have an R&S SMW200A and want to equip it with option R&S SMW-K575, contact Rohde & Schwarz.

**Related step-by-step instructions**

See the following sections:

- ["To optimize I/Q modulation for best EVM performance"](#) on page 462
- ["To linearize the RF signal automatically"](#) on page 462
- ["To linearize the RF signal manually"](#) on page 463
- ["To apply user-defined optimization characteristics"](#) on page 464

**Related settings**

See [Section 7.4.2, "Optimizations settings"](#), on page 471.

## 7.3 Optimizing I/Q modulation performance

In the following sections, we assume that:

- The R&S SMW200A generates a baseband signal
- A spectrum analyzer is connected to the R&S SMW200A, the analyzer is configured, and measures the required signal characteristics.

- [General I/Q modulation tasks](#).....460
- [Using optimization characteristics](#).....461
- [Improving the output signal quality](#).....465

### 7.3.1 General I/Q modulation tasks

The following step-by-step instructions help you to execute general I/Q modulation tasks with dedicated I/Q modulator settings:

- ["To use the default settings"](#) on page 460
- ["To generate a wideband modulation signal"](#) on page 461
- ["To correct systematic I/Q modulation errors"](#) on page 461

**To use the default settings**

- ▶ In the block diagram, select "I/Q Mod" > "I/Q Settings" > "I/Q Modulator" > "On".

The I/Q modulator is enabled. Modulated is the internal baseband signal.

The I/Q modulator provides a vector-modulated signal that is optimized for time-sensitive measurements and lower noise at high switching speeds.

**To generate a wideband modulation signal**

1. In the block diagram, select "I/Q Mod" > "I/Q Settings" > "I/Q Modulator" > "On".

The I/Q modulator is enabled. Modulated is the internal baseband signal.

2. Select "I/Q Wideband" > "On".

The R&S SMW200A shifts the switching frequencies of the lowpass filters in the output section and generates a signal with a higher I/Q modulation bandwidth. The harmonic suppression, however, degrades.

**To correct systematic I/Q modulation errors**

Adjust the I/Q modulator for a given carrier frequency to correct systematic errors, for example temperature fluctuations of several degrees. These corrections ensure precise and repeatable measurements.

1. Select "System Config" > "Setup" > "General" > "Internal Adjustments".
2. Select "Adjust I/Q Modulator Current Frequency".

See also [Section 17.3.4.3, "How to use the internal adjustments"](#), on page 1371.

### 7.3.2 Using optimization characteristics

The following step-by-step instructions help you to optimize I/Q modulation to achieve an optimized value of a certain measure or signal parameter:

- ["To enable modulation with the baseband signal"](#) on page 461
- ["To optimize I/Q modulation for best EVM performance"](#) on page 462
- ["To linearize the RF signal automatically"](#) on page 462
- ["To check if calibration data is available"](#) on page 463
- ["To linearize the RF signal manually"](#) on page 463
- ["To apply user-defined optimization characteristics"](#) on page 464

**To enable modulation with the baseband signal**

All step-by-step instructions in this section require the signal from the baseband domain as the modulation source. This signal can be the internal baseband signal or an external digital I/Q signal.

1. Select "I/Q Mod" > "I/Q Settings" > "I/Q Modulator".
2. Select "General" > "Source" > "Internal Baseband".
3. Select "State" > "On".

The I/Q modulator is enabled. The modulation source is the signal from the baseband domain.

### To optimize I/Q modulation for best EVM performance

If your test setup requires the lowest EVM values, use the "Optimize EVM" function of the R&S SMW200A. For example, if you need to generate 5G NR signals, LTE signals or IEEE 802.11 signals that require best EVM performance.

1. Use the signal from the baseband domain as a modulation source.  
See ["To enable modulation with the baseband signal"](#) on page 461.
2. Select "I/Q Mod" > "I/Q Settings" > "Optimizations".
3. Select "Optimization Characteristics" > "Optimize EVM".

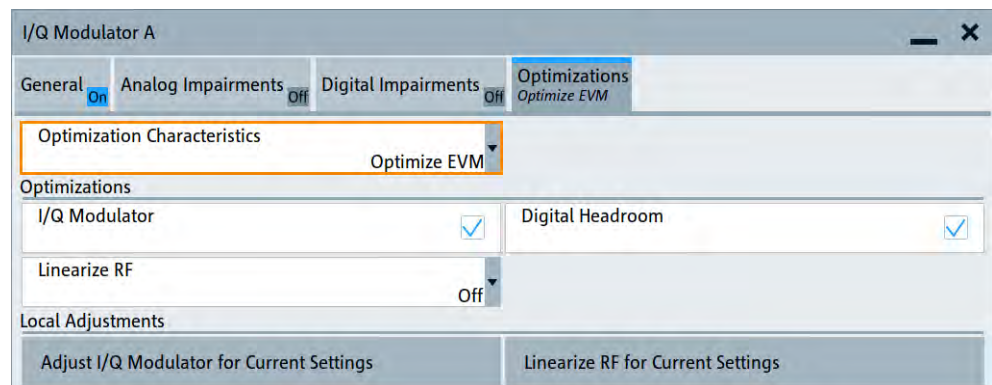

If enabled, the frequency section of the status bar displays the enabled EVM optimization state as in [Figure 7-1](#).



**Figure 7-1: Optimize EVM enabled**

4. On a connected signal analyzer, monitor the signal characteristics.

### To linearize the RF signal automatically

Linearizing the RF signal automatically requires R&S SMW-K575.

1. Use the signal from the baseband domain as a modulation source.  
See ["To enable modulation with the baseband signal"](#) on page 461.
2. Select "I/Q Mod" > "I/Q Settings" > "Optimizations".
3. Select "Linearize RF" > "Auto".

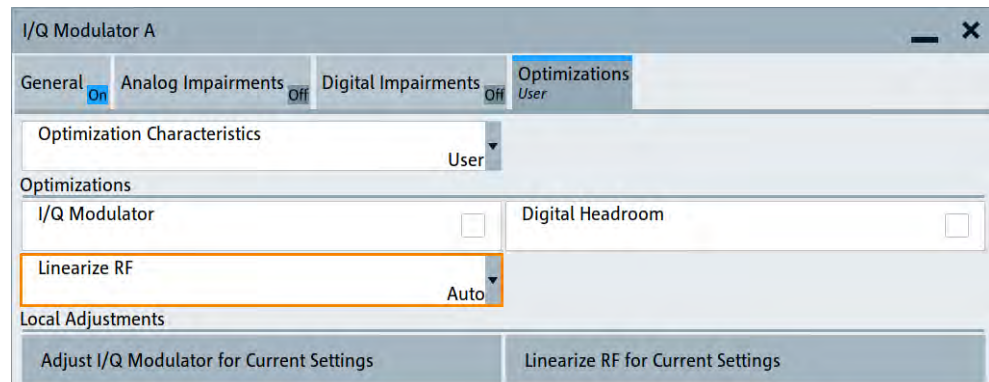

The instrument uses the AM/AM and AM/PM predistortion data from a factory calibration to linearize the RF output signal at high output powers. If you cannot select "Auto", the calibration data is not available on your instrument. See ["To check if calibration data is available"](#) on page 463.

4. On a connected signal analyzer, monitor the signal characteristics.

#### To check if calibration data is available

If you cannot select the automatic RF linearization functionality ("Linearize RF" > "Auto"), check if your instrument has calibration data:

1. Select "Setup" > "Instrument Assembly" > "Versions / Options".
2. Select the "Versions" tab.
3. In the column "Package", check the line "K575 CalData".

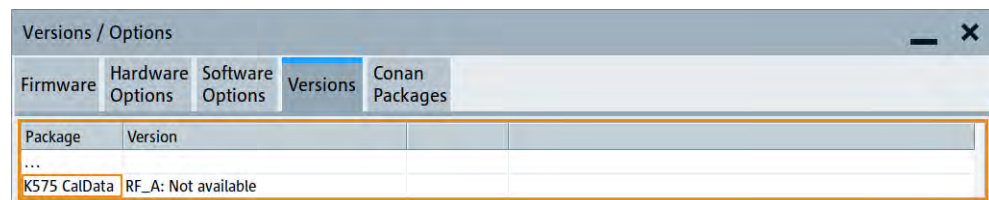

The "Version" column displays if calibration data is available or not. If it displays "Not available" contact Rohde & Schwarz. See also ["Installing option R&S SMW-K575"](#) on page 460.

#### To linearize the RF signal manually

Linearizing the RF signal requires R&S SMW-K541 or R&S SMW-K575.

1. Use the signal from the baseband domain as a modulation source. See ["To enable modulation with the baseband signal"](#) on page 461.
2. Select "I/Q Mod" > "I/Q Settings" > "Optimizations".
3. Select "Local Adjustments" > "Linearize RF for Current Settings".

The instrument measures the AM/AM nonlinearity on the RF chain for the current frequency. During the measurement, the instrument interrupts signal generation.

4. Select "Optimizations" > "Linearize RF" > "Manual".

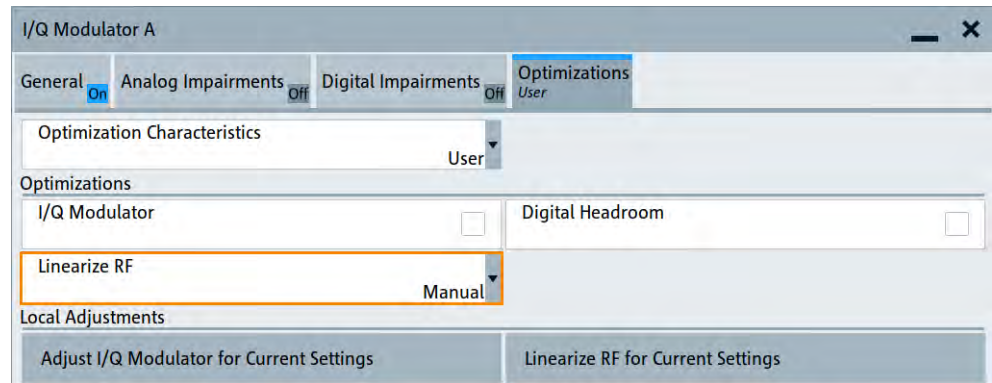

The instrument uses the measured AM/AM correction data. If the option R&S SMW-K575 is also installed on your instrument, the manual mode also uses AM/PM calibration data from the factory calibration.

5. On a connected signal analyzer, monitor the signal characteristics.

#### To apply user-defined optimization characteristics

For a given baseband signal and RF frequency, perform the following:

1. Select "I/Q Mod" > "I/Q Settings" > "I/Q Modulator".
2. Select "General" > "State" > "On".

The I/Q modulator is enabled. Modulated is the internal baseband signal.

3. Select "I/Q Mod" > "I/Q Settings" > "Optimizations".
4. In the "Optimizations" section, select a user-defined optimization setting, for example:
  - a) Select "I/Q Modulator" > "On".
  - b) Select "Digital Headroom" > "Off".
  - c) Select "Linearize" > "Off".

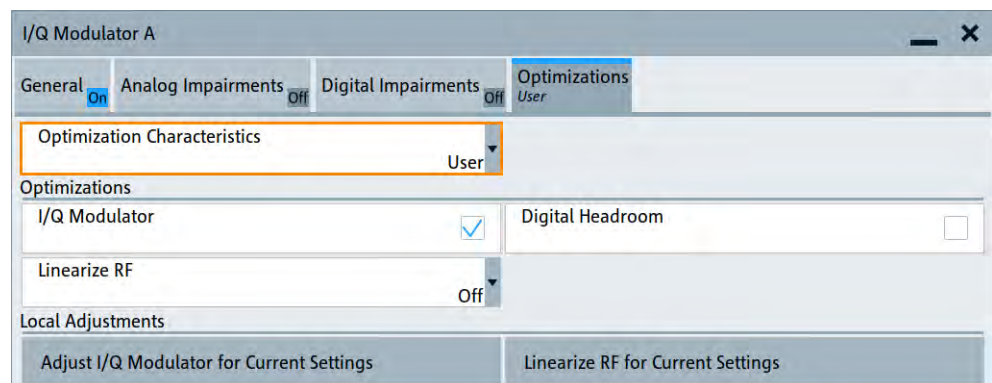

The parameter "Optimization Characteristics" > "User" indicates a user-defined setting.



5. On a connected signal analyzer, monitor the signal characteristics.

### 7.3.3 Improving the output signal quality

The following step-by-step instructions help you to improve the quality of the RF output signal with dedicated I/Q modulator settings:

- "To improve signal flatness" on page 465
- "To optimize for signals with high ACPR" on page 465
- "To minimize signal intermodulation" on page 465

#### To improve signal flatness

For a given baseband signal and RF frequency, perform the following:

1. In the block diagram, select "I/Q Mod" > "I/Q Settings" > "I/Q Modulator" > "On".

The I/Q modulator is enabled. Modulated is the internal baseband signal.

This mode generates a flat signal but requires longer settling time and leads to signal interruption.

2. Select "Optimization Mode" > "High Quality".

**Note:**

Do not enable both the I/Q optimization mode "High Quality" and the RF signal level optimization mode "Uninterrupted" or "Strictly Monotone". The high-quality I/Q optimization mode leads to an RF signal interruption which blocks the RF signal level optimization.

3. On a connected signal analyzer, monitor the signal characteristics.

#### To optimize for signals with high ACPR

Optimize the I/Q modulator for signals with high adjacent channel power ratio (ACPR). For a given baseband signal (e.g. a 3GPP signal) and RF frequency, perform the following iterative steps:

1. In the block diagram, select "I/Q Mod" > "I/Q Settings" > "I/Q Modulator" > "On".

The I/Q modulator is enabled. Modulated is the internal baseband signal.

2. Select "Baseband Gain" = "6 dB".
3. On a connected signal analyzer, monitor the signal characteristics.
4. Vary the value of the parameter "Baseband Gain" until the maximal signal-to-noise ratio (SNR) is achieved.

#### To minimize signal intermodulation

For a given baseband signal and RF frequency, perform the following iterative steps:

1. In the block diagram, select "I/Q Mod" > "I/Q Settings" > "I/Q Modulator" > "On".

The I/Q modulator is enabled. Modulated is the internal baseband signal.

2. If enabled, disable the "I/Q Wideband" > "Off".

3. Select "Baseband Gain" = "-2 dB".
4. On a connected signal analyzer, monitor the signal distortion characteristics.
5. Vary the value of the parameter "Baseband Gain" until the maximal suppression of the intermodulation products is achieved.

## 7.4 I/Q modulator settings

Access:

1. To choose the input signal of the I/Q modulator, select one of the following:
  - For the internal baseband signal, select "I/Q Mod" > "I/Q Modulator Input" > "Internal Baseband".
  - For an analog wideband input signal, select "I/Q Mod" > "I/Q Modulator Input" > "Analog Wideband I/Q Input".
  - For a differential analog input signal, select "I/Q Mod" > "I/Q Modulator Input" > "Differential Analog I/Q Input".

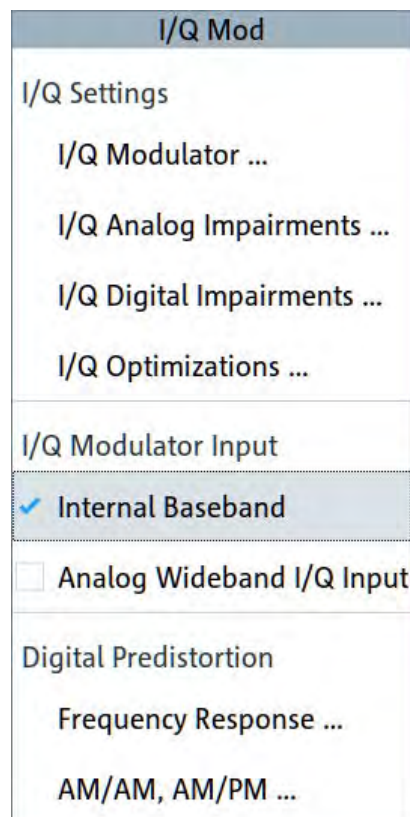

See also "[Source](#)" on page 468.

2. Select "I/Q Mod" > "I/Q Settings" > "I/Q Modulator".

The dialog provides the I/Q modulator settings, settings for optimized wideband modulation and settings for applying analog or digital impairments.

The remote commands required to define these settings are described in [Section 14.19.10, "SOURce:IQ subsystem"](#), on page 1209.

For a description on applying digital impairments and applying nonlinear effects, see the following sections:

- [Section 6.4, "Impairing the signal"](#), on page 449
- [Section 7.4.2, "Optimizations settings"](#), on page 471

See the user manual R&S SMW-K540, R&S SMW-K541 Envelope Tracking and AM/AM, AM/PM Predistortion.

See the user manual "R&S SMW-K544 User-Defined Frequency Response Correction".

#### Settings:

- [General settings](#).....467
- [Optimizations settings](#).....471

### 7.4.1 General settings

Access:

- ▶ Select "I/Q Mod" > "I/Q Settings" > "I/Q Modulator".

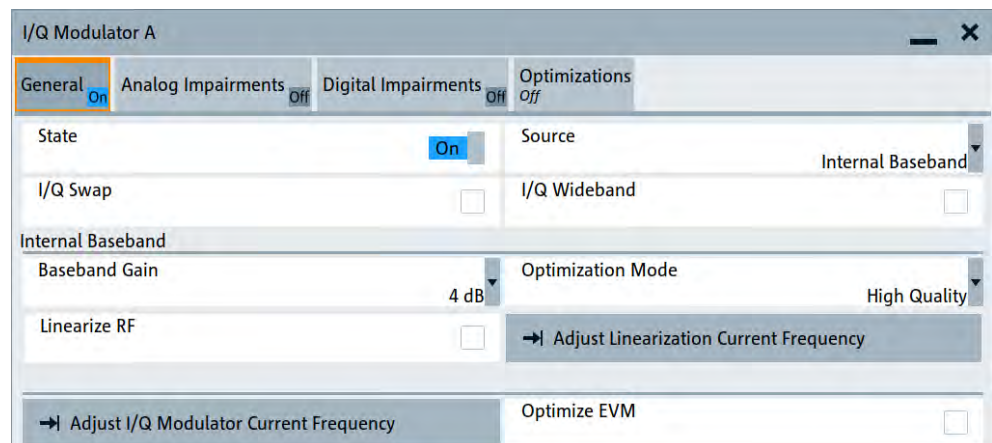

The tab provides the general I/Q modulator settings.

#### Settings:

- [State](#).....468
- [Source](#).....468
- [I/Q Swap](#).....468

I/Q Wideband.....	469
Crest Factor.....	469
Baseband Gain.....	470
Optimization Mode.....	470

**State**

Enables I/Q modulation.

If you use the internal baseband signal as the input signal and enable baseband signal generation, the I/Q modulator is enabled automatically. You can disable I/Q modulation, for example, if you want to route the baseband signal directly to the I/Q output connectors.

Remote command:

[ :SOURce<hw> ] :IQ:STATe on page 1210

**Source**

Selects the input signal for the I/Q modulator.

Enabling the I/Q modulator for external source signals disables an enabled amplitude modulation of the RF output signal. See also [Table 7-1](#).

"Internal Baseband"

Selects the internal baseband signal.

"Analog Wideband I/Q Input"

Selects an external analog signal.

See also ["To apply an external analog signal directly to the I/Q modulator"](#) on page 211.

"Differential Analog I/Q Input"

Option: R&S SMW-K739, for RF path A.

Selects an external differential analog signal.

If the instrument is equipped with one of the [High frequency options](#) and a "Freq > 19.5 GHz" is selected, the "Analog Wideband I/Q Input" is automatically selected.

Remote command:

[ :SOURce<hw> ] :IQ:SOURce on page 1210

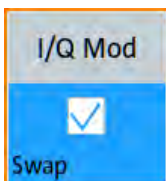
**I/Q Swap**

Selects normal or swapped I/Q control for the generated signal.

The I/Q modulator defined in the IS2000 standard differs from the definition in this implementation. The definition on which the implementation is based is used by virtually all digital communication standards, except IS95 and IS2000.

In the final step, the filtered I/Q signal is modulated to the desired RF in a different way in the I/Q modulator:

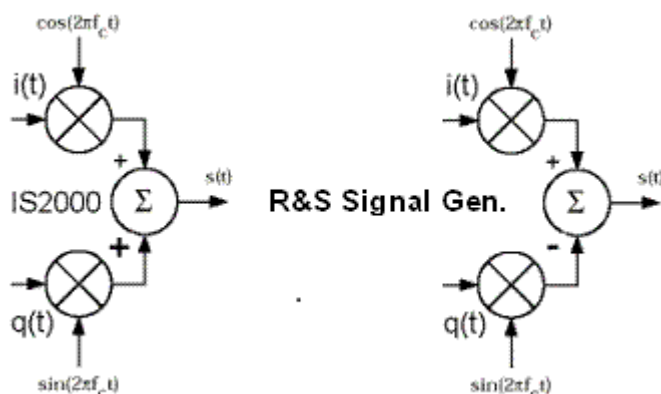

Figure 7-2: Definition of I/Q modulator in IS2000 and the R&S SMW200A

IS2000 = The RF signal  $s(t)$  is derived from the baseband I/Q signal as  $s(t) = i(t)\cos(2\pi f_c t) + q(t)\sin(2\pi f_c t)$

R&S SMW = The RF signal  $s(t)$  is based on the definition  $s(t) = i(t)\cos(2\pi f_c t) - q(t)\sin(2\pi f_c t)$

See also:

- Description "CDMA2000® incl. EV-DV Digital Standard for R&S SMW200A"
- Description "1xEV-DO Rev. A, Rev. B Digital Standard for R&S SMW200A"

"Off" I/Q control is normal.

"On" The modulation sidebands are inverted by swapping the I and Q signals (the Q-part of the signal is inverted).  
The generated baseband signal is according to standards CDMA2000 and 1xEV-DO.

Remote command:

`[ :SOURCE<hw> ] :IQ:SWAP [ :STATE ]` on page 1212

### I/Q Wideband

Activates/deactivates optimization for wideband modulation signals (higher I/Q modulation bandwidth).

The modulation frequency response of the R&S SMW200A in the useful bandwidth is improved at the expense of poorer harmonic suppression. This improvement is achieved by shifting the switching frequencies of the lowpass filters in the output section.

Remote command:

`[ :SOURCE<hw> ] :IQ:WBState` on page 1212

### Crest Factor

Requires an external analog I/Q input signal, for example "Source" > "Analog Wideband I/Q Input".

Sets the crest factor of the external analog I/Q signal.

The crest factor is the difference in level between the peak envelope power (PEP) and the average power value (RMS) in dB. The R&S SMW200A uses this value for the calculation of the RF output power.

For more information, see [Section 4.3.5, "Important signal parameters and interface characteristics"](#), on page 114.

**Note:**

To set the crest factor of an external digital input signal, use the following parameter:

- "BB Input" > "Input Level" > [Crest Factor](#).
- "BB Input" > "Input Level" > [Crest Factor](#).

See also ["To apply an external analog signal directly to the I/Q modulator"](#) on page 211.

Remote command:

[\[:SOURce<hw>\]:IQ:CREStfactor](#) on page 1211

**Baseband Gain**

Sets the baseband gain for a wide dynamic range.

You can amplify the baseband signal power level (positive gain) or attenuate this level (negative gain) to optimize the I/Q modulation performance. The optimization is a trade-off between signal distortion and signal-to-noise ratio (SNR).

Setting the gain has no effect for instruments with output frequencies higher than 19.5 GHz, for example R&S SMW-B1020.

How to: ["To optimize for signals with high ACPR"](#) on page 465

"-4 dB"/"-2 dB"

Attenuates the baseband signal internally to minimize signal distortions and optimize the intermodulation characteristics of the modulated signal. But the SNR decreases, the signal noise increases.

"0 dB"

No changes on the baseband signal, applies no optimization.

"2 dB"/"4 dB"/"6 dB"/"8 dB"

Amplifies the baseband signal internally to maximize the SNR while minimizing the signal noise is minimized. But the signal distortions increase.

Use amplified baseband signals, for example, for 3GPP signals with high adjacent channel power ratio (ACPR).

"Auto"

Requires a connected R&S SZU. The R&S SMW200A automatically sets the gain with optimized adjustment data from the R&S SZU.

Remote command:

For the analog I/Q signal:

[\[:SOURce<hw>\]:IQ:GAIN](#) on page 1210

For digital I/Q signal:

[\[:SOURce<hw>\]:BB:IQGain](#) on page 1210

**Optimization Mode**

Requires "Source" > "Internal Baseband".

Selects the optimization mode for I/Q modulation of the internal baseband signal. This optimization mode applies for the I/Q modulation performance and for the user-defined frequency response corrections.

How to:

- [Section 7.3, "Optimizing I/Q modulation performance"](#), on page 460
- [Section "Applying user-defined frequency response corrections"](#) in the user manual "R&S SMW-K544 User-Defined Frequency Response Correction".

For more information, refer to the specifications document.

- "Fast" Fast optimization with high switching speed by compensating for I/Q skew. This mode is suitable in time sensitive environments and for narrowband signals. Also, this mode disables I/Q modulation optimizations ("Optimization Characteristics" > "Off").
- "High Quality" Optimizes I/Q modulation by compensating for I/Q skew and frequency response correction. This mode generates a flat signal over a large bandwidth but requires a longer setting time and leads to signal interruption.

**Note:**

Do not enable both the I/Q optimization mode "High Quality" and the RF signal level optimization mode "Uninterrupted" or "Strictly Monotone". The high-quality I/Q optimization mode leads to an RF signal interruption which blocks the RF signal level optimization.

"High Quality Table"

Improves the frequency response while maintaining setting time, there is no signal interruption.

Select this mode if your setup requires repeatable settings together with high-quality optimization or if you have wideband baseband input signals. The mode is useful in the following cases:

- To optimize I/Q modulation in setups to generate phase coherent signals. See [Section 10.2, "Generating phase coherent signals"](#), on page 663.
- To optimize I/Q modulation if you generate upconverted I/Q signals, for example with a connected R&S SZU. See ["To connect and configure an R&S SZU"](#) on page 195.
- To optimize I/Q modulation in setups to digital predistortion setups. See the R&S SMW200A envelope tracking user manual.

Remote command:

`[ :SOURce<hw> ] :BB:IMPairment:OPTimization:MODE` on page 1173

## 7.4.2 Optimizations settings

Access:

- ▶ Select "I/Q Mod" > "I/Q Settings" > "Optimizations".

The tab provides settings to configure optimized I/Q modulation methods of the internal baseband signal.

The remote commands required to define these settings are described in [Section 14.19.10, "SOURce:IQ subsystem"](#), on page 1209.

**Settings:**

Optimization Characteristics.....	472
Optimizations.....	472
I/Q Modulator.....	472
Digital Headroom.....	473
Linearize RF.....	473
Local Adjustments.....	474
Adjust I/Q Modulator for current settings.....	474
Linearize RF for current settings.....	474

**Optimization Characteristics**

Selects the method for optimizing the I/Q modulation.

"Off" No dedicated I/Q modulation optimization.

"Optimize EVM"

Optimizes I/Q modulation to achieve better EVM performance. This method reduces the wideband noise and improves the nonlinear effects of amplifiers resulting in a linear gain. The table [Table 7-2](#) provides an overview on related parameters and their values. These values are different for an instrument that is equipped with option R&S SMW-K575 and without option R&S SMW-K575.

**Table 7-2: Optimize EVM parameters and values**

Parameter	With R&S SMW-K575 *)	Without R&S SMW-K575
"I/Q Modulator"	"On"	"On"
"Digital Headroom"	"On"	"On"
"Linearize RF"	"Auto"	"Off"

\*) If equipped with option R&S SMW-K575 and factory calibration data, the method executes a static digital predistortion (DPD) without considering memory effects.

"User" Selects or indicates a user-defined setting of the settings in the "Optimizations" section. These settings imply a changed setting compared to the "Optimize EVM" optimizations.

Remote command:

`[ :SOURce<hw> ] :CORRection:OPTimize:RF:CHARacteristics` on page 1195

**Optimizations**

Provides settings to configure the optimization parameters individually:

- ["I/Q Modulator"](#) on page 472
- ["Digital Headroom"](#) on page 473
- ["Linearize RF"](#) on page 473

**I/Q Modulator**

Enables automatic adjustments of the I/Q modulator after each RF frequency change or RF level change.

"Off" No adjustment of the I/Q modulator.



"On" Adjusts the I/Q modulator automatically after each RF frequency change or RF level change.

Remote command:

[\[:SOURce<hw>\]:CORRection:OPTimize:RF:IQModulator](#) on page 1195

### Digital Headroom

Enables an enhanced digital headroom up to full scale for a better signal-to-noise ratio. This enhancement implies an optimization for the current settings after each RF frequency change and RF level change.

"Off" No enhanced digital headroom.  
Also, you need to trigger optimization for current settings manually. Select "I/Q Mod" > "Frequency Response" > "General" > "Optimize for current settings".

See the user manual "R&S SMW-K544 User-Defined Frequency Response Correction".

"On" Enhanced digital headroom with automatic optimization for current settings after each RF frequency change and RF level change.

Remote command:

[\[:SOURce<hw>\]:CORRection:OPTimize:RF:HEADroom](#) on page 1195

### Linearize RF

Requires R&S SMW-K541 or R&S SMW-K575.

Selects the mode to apply a digital predistortion (DPD) to the nonlinear RF chain to linearize the RF signal.

During the calculation and RF linearization, the following applies:

- The instrument interrupts signal generation.
- If only equipped with option R&S SMW-K541, the settings for the digital predistortion AM/AM and AM/PM are disabled.

"Off" Disables the linearization of the RF chain of the instrument.

"Auto" Requires R&S SMW-K575. Applies an automatic AM/AM predistortion and AM/PM predistortion to the RF chain of the instrument. This mode requires factory calibration data available on the instrument. If your instrument has no calibration data, this mode is not available.

How to: ["To linearize the RF signal automatically"](#) on page 462

"Manual" Requires R&S SMW-K541.  
This mode uses an AM/AM correction data from the function "Linearize RF for current settings" to linearize the RF chain of the instrument. Select "Linearize RF for current settings" before using the manual mode.  
If the R&S SMW-K541 is installed on your instrument and the option R&S SMW-K575 is not installed, you cannot load user-defined digital predistortions. The R&S SMW-K541 functionality for digital predistortion is not available.  
If the option R&S SMW-K575 is also installed on your instrument, the manual mode also uses AM/PM calibration data from the factory calibration.  
How to: ["To linearize the RF signal manually"](#) on page 463

If you select the auto mode or manual mode, the function "Calculate Envelope from predistorted signal" is not available.

Remote command:

`[ :SOURce<hw> ] :CORRection:OPTimize:RF:LINearize` on page 1196

### Local Adjustments

Provides settings to trigger the local adjustments of the I/Q modulator and AM/AM distortions of the RF output signal:

- ["Adjust I/Q Modulator for current settings"](#) on page 474
- ["Linearize RF for current settings"](#) on page 474

### Adjust I/Q Modulator for current settings

Starts the adjustment of the I/Q modulator for the current settings of the RF frequency, RF level, baseband gain and optimizations.

Remote command:

`[ :SOURce<hw> ] :CORRection:OPTimize:RF:IQModulator:ADJust?`  
on page 1196

### Linearize RF for current settings

Requires R&S SMW-K541.

Measures the AM/AM nonlinearity on the RF chain for the current frequency. During the measurement, the instrument interrupts signal generation.

Execute "Linearize RF for current settings" before setting the mode "Linearize RF" > "Manual", see ["Linearize RF"](#) on page 473.

Remote command:

`[ :SOURce<hw> ] :CORRection:OPTimize:RF:LINearize:ADJust?` on page 1197

## 8 Configuring the RF signal

The vector signal generator R&S SMW200A generates RF signals with outstanding spectral purity within the frequency range from 100 kHz up to 67 GHz and with adjustable signal level over a wide range.

In addition to these real-time CW signals, you can generate RF signals from predefined lists and sweep signals that vary according to the frequency or amplitude curves.

You can also apply versatile analog modulation types with definable characteristics.

The variably adjustable output level due to the built-in attenuator, allows you to vary the RF signal level over the full level range. There are different methods to improve signal performance and to optimize the signal quality for the particular application, or to increase the accuracy and reliability of the generated RF signal.

The R&S SMW200A supports R&S NRP power sensors, e.g. to monitor the output level of the generator or to determine the level correction values for user correction lists.

### Signal modes and characteristics

The R&S SMW200A generates unmodulated or analog modulated RF signals. You can output the signal in fixed mode or as a signal having periodically varying frequencies or amplitudes.

**Signal modes** for RF signal generation:

- Unmodulated signal  
Generates an unmodulated continuous wave (CW) of constant frequency and amplitude.  
For information on the signal frequency and level settings and example on how to configure a simple CW signal, see:
  - [Section 8.5, "RF frequency settings"](#), on page 481
  - [Section 8.6, "RF level settings"](#), on page 485
  - [Section 8.7, "RF phase settings"](#), on page 490
  - [Section 3.3.1, "Generating an unmodulated carrier"](#), on page 54
- Analog modulated signal  
Modulates the signal with an analog signal and generates amplitude, phase, frequency and pulse modulation.

See [Section 8.11, "Analog modulations"](#), on page 546.

- Vector modulated signal  
Generates an I/Q vector modulated signal  
See [Section 7, "Applying I/Q vector modulation"](#), on page 458.

The R&S SMW200A allows you to provide the RF signal with constant or varying frequencies and/or amplitudes at the output:

- Constant frequency and level (CW/Fixed mode)  
The RF output signal has the set frequency and level.
- Varying frequency and/or level

- Sweep mode  
An RF or LF frequency and RF level sweep signal, processed continuously, step-by-step or individually and with selectable trigger modes. You can only run one sweep at a time.
- List mode  
The RF signal is based on a list of predefined frequency and level values pairs and step widths.

See [Section 8.10, "Varying the RF signal in list or sweep mode"](#), on page 509.

## 8.1 Required options



To improve the signal performance of the R&S SMW200A, several hardware components in the RF domain have been replaced. New option numbers denote the hardware modifications.

Accordingly, the description in the user manual has been extended. It applies to all new options, as for example R&S SMW-B1006, but also comprises the former ones.

Differences to instruments with the former RF hardware are referred to as *earlier RF hardware versions*.

The equipment layout for generating the RF signal includes:

- Option frequency (e.g. R&S SMW-B1003) for signal path A
- Option frequency (e.g. R&S SMW-B2003) for signal path B
- Option baseband main module, one/two I/Q paths to RF (R&S SMW-B13/-B13T) or Option wideband baseband main module two I/Q paths to RF (R&S SMW-B13XT)  
Option R&S SMW-B13T/-B13XT is required for simultaneously vector and an analog frequency or phase modulation in the same path

## 8.2 How to access the RF settings



Access:

1. In the block diagram, select the block "RF > RF".
2. Select the required function from the list.

The RF block covers all functions and settings concerning the RF signal. The settings include the RF frequency and level settings, enhanced functions for improving the signal characteristics, analog modulations, list and sweep mode settings and connector assignments and measurement functions of the RF signal.

The following overview shows all functions of the RF block and leads you to the corresponding descriptions.

Table 8-1: RF block menu

Menu item	Content	Described in ...
<b>RF Frequency</b>		
RF On	Activates RF signal output.	<a href="#">Section 8.3, "How to activate RF signal output"</a> , on page 478
Connectors	The instrument's customizable input and output interfaces: <ul style="list-style-type: none"> <li>• Global connectors</li> <li>• Local connectors</li> </ul>	<a href="#">Section 12.2, "Configuring local and global connectors"</a> , on page 742
Frequency / Phase	<ul style="list-style-type: none"> <li>• RF signal frequency and phase settings</li> <li>• The various possibilities for accessing the frequency settings</li> <li>• Impact of a downstream instrument to the frequency display</li> </ul>	<a href="#">Section 8.4, "How to set the frequency and level"</a> , on page 479
Reference Frequency / LO Coupling	<ul style="list-style-type: none"> <li>• Internal and external reference frequency</li> <li>• Local oscillator (LO)</li> <li>• LO coupling</li> </ul>	<a href="#">Section 8.8, "Reference oscillator"</a> , on page 491 and <a href="#">Section 8.9, "Local oscillator coupling"</a> , on page 500
<b>RF Level</b>		
Level	<ul style="list-style-type: none"> <li>• RF signal level settings</li> <li>• The various possibilities for setting the level</li> <li>• Impact of a downstream instrument to the level display</li> </ul>	<a href="#">Section 8.4, "How to set the frequency and level"</a> , on page 479
Attenuator	The electronic step attenuator settings.	<a href="#">Section 8.12.1, "Attenuator"</a> , on page 581
Power on / EMF	<ul style="list-style-type: none"> <li>• Determine the state of the RF signal output at power-on</li> <li>• Voltage level display in the status bar (no-load voltage)</li> </ul>	<a href="#">Section 12.1.4, "Defining the RF signal state on power on"</a> , on page 740
Automatic Level Control	The automatic adaptive control system to stabilize the RF output level.	<a href="#">Section 8.12.2, "ALC - automatic level control"</a> , on page 584
User Correction	The level correction function for compensating external losses.	<a href="#">Section 8.12.3, "User correction"</a> , on page 588
<b>RF Measurement</b>		<a href="#">Section 8.12.4, "Using power sensors"</a> , on page 600
Power Viewer	Function for monitoring and measuring the RF output power.	<a href="#">Section 8.12.4.2, "NRP power viewer"</a> , on page 602
Power Control	Function to achieve a precise and constant output level with a downstream closed loop power control circuit.	<a href="#">Section 8.12.4.3, "NRP power control"</a> , on page 605
Sensor Configuration	Settings for connected R&S NRP power sensors.	<a href="#">Section 8.12.4.4, "NRP sensor configuration"</a> , on page 610

Menu item	Content	Described in ...
Sensor Mapping	Function for assigning R&S NRP power sensors to the four sensor channels.	<a href="#">Section 8.12.4.5, "NRP sensor mapping"</a> , on page 615
<b>Analog Modulation</b>	All settings for analog modulations, including the LF signal and some typical examples.	<a href="#">Section 8.11, "Analog modulations"</a> , on page 546
Amplitude / Frequency / Phase Modulation	AM, FM and PhiM settings.	<a href="#">Section 8.11.4, "Modulation settings"</a> , on page 557
Pulse Modulation	Pulse modulation settings: <ul style="list-style-type: none"> <li>• General settings</li> <li>• Pulse generator settings</li> <li>• Graphical display of the pulse signal</li> </ul>	<a href="#">Section 8.11.4.1, "Pulse modulation settings"</a> , on page 557
Modulation Source	Signal sources for the LF signal: <ul style="list-style-type: none"> <li>• Internal signal generators</li> <li>• Externally applied LF signal</li> <li>• LF signal shapes</li> </ul>	<a href="#">Section 8.11.2, "Modulation signals"</a> , on page 549 and <a href="#">Section 8.11.2.4, "Modulation signal waveforms"</a> , on page 554
LF Output	Configures the LF signal for output.	<a href="#">Section 8.11.4.6, "Output settings"</a> , on page 575
<b>Sweep / List</b>	Information on configuring an RF signal with varying frequencies or amplitudes, either in Sweep or List Mode.	<a href="#">Section 8.10, "Varying the RF signal in list or sweep mode"</a> , on page 509
RF Frequency / RF Level Sweep / LF Frequency Sweep	Sweep mode settings.	<a href="#">Section 8.10.5, "Sweep mode settings"</a> , on page 525
List Mode	List mode settings.	<a href="#">Section 8.10.6, "List mode settings"</a> , on page 535

## 8.3 How to activate RF signal output

By default, the RF output signal is disabled. When you activate the RF output, the instrument restores the previously set signal configuration

### To activate the RF output

1. Configure the RF signal as required.  
Set, for example, the frequency and level values.
2. Enable the RF output in one of the following ways:
  - a) In the status bar, select the "RF On" icon and enable RF.
  - b) In the block diagram, select the "On" checkbox of the RF block.
  - c) In the RF level settings menu, select "Level > RF ON > On"
  - d) At the front panel, press the [RF ON/OFF] key.

The blue color of the "RF On" icon and the RF block indicate that the RF signal output is enabled.

RF State/RF ON.....	479
PEP.....	479
RF output impedance.....	479

**RF State/RF ON**

Activates or deactivates the RF output.

Acts as the [RF ON/OFF] key.

Remote command:

`:OUTPut<hw>[:STATe]` on page 945

`:OUTPut:ALL[:STATe]` on page 945

**PEP**

Displays the PEP (Peak Envelope Power) in the status bar. This value corresponds to the level specification of a digital modulation or of a digital standard signal at the RF output.

Remote command:

`[:SOURce<hw>]:POWER:PEP?` on page 1273

**RF output impedance**

You can query the impedance of the RF output.

Remote command:

`:OUTPut<hw>:IMPedance?` on page 947

## 8.4 How to set the frequency and level

The simplest form of the RF signal is a continuous wave (CW) of constant frequency and amplitude. The RF signal is defined by its frequency, level and phase.

**To access the frequency, level and phase settings**

► Use one of the following:

- "Status bar" > "Frequency" / "Level"
- "Status bar" > "RF Off/On" > "RF Frequency" > "Frequency"
- "RF block" > "RF" > "RF Frequency" > "Frequency"
- "RF block" > "RF" > "RF Level" > "Level"
- "RF block" > "RF" > "RF Frequency" > "Phase"
- "Block diagram" > "RF connector label" "RF" > "RF Frequency" > "Frequency", etc.
- At the front panel, press the [FREQ] or the [LEVEL] key.

The frequency and level values are indicated in the "Status bar" so that you can see them at a glance. Values displayed in the status bar and in the "Frequency/Level" dialogs can deviate from each other.

## 8.4.1 References

This section shows how the R&S SMW200A includes the factors of a downstream instrument to provide an optimal RF signal for the DUT.

### 8.4.1.1 Displayed RF frequency and level values with downstream instruments

If you are working with a downstream instrument, like a mixer, a frequency multiplier, an amplifier or an attenuator, you can enter the parameter (offset, multiplier, amplitude) of the downstream instrument in the frequency or level settings dialog of the R&S SMW200A.

The generator includes these parameters and displays the result in the "Freq" and "Lev" fields in the status bar, as if the downstream instrument and the generator were one unit. Thus, the displayed value corresponds to the value at the RF output of the downstream instrument.

The R&S SMW200A generates the signal without the downstream parameters, but considers all additional features concerning the RF level, like digital attenuation, user correction, etc.

#### RF frequency and level display with a downstream instrument

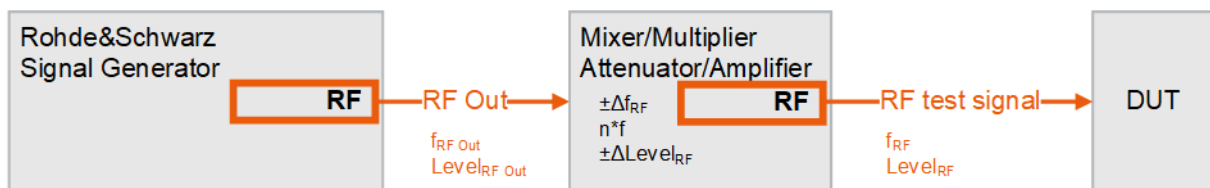

**Figure 8-1: Frequency and Level display vs. frequency and level at the RF output**

$f_{RF}$ , $Level_{RF}$	= Frequency and level ("Status bar" > "Frequency" and "Level") at the output of the downstream instrument.
$f_{RF Out}$ , $Level_{RF Out}$	= Frequency and level at the output connector [RF A/RF B] ("RF" > "RF Frequency" > "Frequency" and "RF" > "RF Level" > "Amplitude")
$n*f$	= Multiplication factor ("RF" > "RF Frequency" > "Multiplier")
$\Delta f$	= Frequency offset ("RF" > "RF Frequency" > "Offset")
$\Delta Level$	= Power offset ("RF" > "RF Level" > "Offset")

As shown on [Figure 8-1](#), there are further parameters in addition to the frequency and amplitude, which affect the RF signal for the DUT, e.g. impacts of subsequent instruments. To include these impacts already in the configuration, you can set the related parameters directly in the dialogs (see [RF frequency settings](#), or [RF level settings](#)).

#### Calculation of $f_{RF}$ and $Level_{RF}$

- $f_{RF} = n * f_{RF Out} + \Delta f$
- $Level_{RF} = Level_{RF Out} + \Delta Level + Level_{DigAtt}$   
( $Level_{DigAtt}$  for active internal I/Q modulation, "RF" > "RF Level" > "Digital Attenuation")



In the "Freq" and "Lev" fields of the status bar, the R&S SMW200A shows the results of the following correlations:



1 = Status bar (display)  
2,3,4 = (frequency settings dialog)



1 = Status bar (display)  
2,3,4 = (level settings dialog)



The level displayed in the status bar includes "Amplitude", "Offset" and "Digital Attenuation".

"Offset" represents a level value that impacts the RF signal outside the R&S SMW200A. In contrast, the "Digital attenuation" directly affects the level value at the RF output.

Further settings that affect the level at the RF output, like user correction, are indicated by an icon in the status bar.

## 8.5 RF frequency settings

Access:

- ▶ Select "RF" > "RF Frequency" > "Frequency".

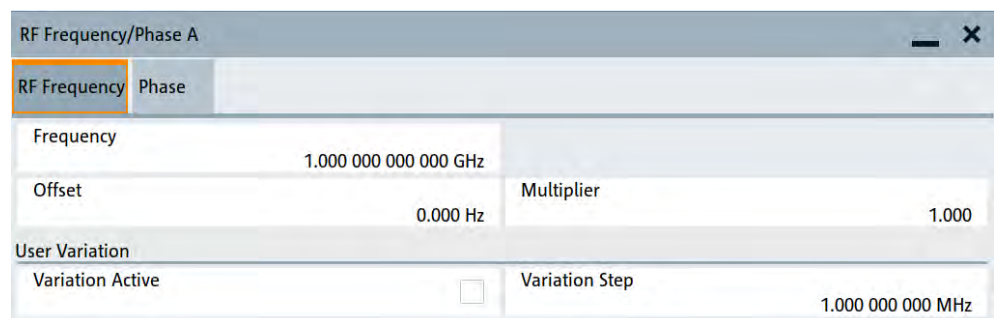

In the "RF Frequency" dialog, you can configure:

- RF frequency, incl. an offset or multiplication factor of a downstream instrument
- The step size for varying the frequency with the rotary knob.
- The frequency overrange, If an R&S SZU is connected, see "[Frequency Overrange](#)" on page 484.

The remote commands required to define the settings are described in [Section 14.19.7, "SOURCE:FREQUENCY subsystem"](#), on page 1197.

**Settings:**

Frequency.....	482
Offset.....	482
Multiplier.....	483
Converter Mode.....	483
Frequency Overrange.....	484
L Frequency Overrange Active.....	484
L Minimal Frequency.....	484
L Maximal Frequency.....	484
User Variation.....	485
L Variation Active.....	485
L Variation Step.....	485

**Frequency**

Sets the RF frequency.

This frequency is output at the RF A/RF B connector.

It does not consider any parameter that affect the frequency, as e.g., a frequency offset.

See [Section 8.4.1.1, "Displayed RF frequency and level values with downstream instruments"](#), on page 480.

**Note: Suppressed values in the status bar**

For security concerns or certain operating modes, you can hide the frequency and level display in the status bar.

- **\*\*\*\*\***

The display has been disabled for security reasons.

See:

- [Annotation Frequency](#)
- [Annotation Amplitude](#)

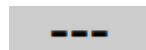

The display is disabled when:

- List mode is running, see [Section 8.10, "Varying the RF signal in list or sweep mode"](#), on page 509.
- Digital only signals are generated, see the user manual "R&S SMW-K551 Generation of Digital "Slow IQ" Signals"

Remote command:

`[ :SOURce<hw> ] :FREQuency [ :CW | FIXed ]` on page 1202

**Offset**

Sets the frequency offset.

This value represents the frequency shift of a downstream instrument, like for example a mixer.

The "Frequency" value displayed in the status bar is the resulting frequency, as it is at the output of the downstream instrument. The frequency at the R&S SMW200A RF output is not changed.

See [Section 8.4.1.1, "Displayed RF frequency and level values with downstream instruments"](#), on page 480.

Remote command:

`[ :SOURce<hw> ] :FREQuency:OFFSet` on page 1204

### Multiplier

Sets the multiplication factor for the RF frequency.

This value represents the multiplication factor of a downstream instrument, as for example a multiplier. You can also assign a negative multiplication factor, for example -1.0 to support frequency converters working in the reverse frequency position.

The "Frequency" value displayed in the status bar is the resulting frequency, as it is at the output of the downstream instrument. The frequency at the R&S SMW200A RF output is not changed.

See [Section 8.4.1.1, "Displayed RF frequency and level values with downstream instruments"](#), on page 480.

Remote command:

`[ :SOURce<hw> ] :FREQuency:MULTiplier` on page 1203

### Converter Mode

Selects the mode for calculating the output frequency of a downstream converter.

#### Example: Functionality of the converter mode

As the R&S SMW200A is a 2 path signal generator, it optimally supports external frequency converters. For convenient operation, this functionality calculates the resulting system frequency.

The converter mixes an I/Q modulated RF signal of the first path with an unmodulated, multiplied signal generated in the second path of the R&S SMW200A.

To configure the converter frequency:

- Set the frequency of the modulation carrier and the multiplication factor in the first path.
- Select the mixing frequency in the second path.  
According to the selected converter mode, the R&S SMW200A shows the resulting frequency in the status bar.

The modes selectable show the basis of the calculation. Due to the interaction of the two paths, active converter modes are mutually exclusive. Depending on the band to be used, select the appropriate mode:

"OFF"                      No converter considered.

"Multiplier \* RFB + RFA" / "Multiplier \* RFA + RFB"  
Uses the upper sideband.

"Multiplier \* RFB - RFA" / "Multiplier \* RFA - RFB"  
Uses the lower sideband.

Remote command:

n.a.

**Frequency Overrange**

This section applies to an R&S SZU100A IQ Upconverter connected to the corresponding path.

An R&S SZU can support a wider frequency range than the range given in the specifications document due to component and manufacturing tolerances. To benefit from the extended range, the R&S SMW200A provides accessing this overrange, e.g. if required for certain test setups.

The R&S SMW200A obtains the calibration data of the R&S SZU when you establish the connection, see ["To connect and configure an R&S SZU"](#) on page 195. If the calibration data confirm an extended range, the R&S SMW200A displays the expanded frequency range, and you can enable the overrange for use.

The remote commands required to define these settings are described in [Section 14.19.8, "SOURCE:FREQUENCY:CONVERTER subsystem"](#), on page 1206.

**Frequency Overrange Active ← Frequency Overrange**

Activates the overrange operation.

The [Minimal Frequency](#) and [Maximal Frequency](#) parameters show the actual frequency range the specific R&S SZU100A provides.

**Note:** The performance in the extended range can deviate from the specified values given in the specifications document of the R&S SZU100A.

**Note:** Preset behavior.

The impact of an instrument preset depends on the "Preset behavior: keep connections to external instruments" setting in the connection configuration:

- Enabled  
The setting is not affected by an instrument preset ([PRESET] key or \*RST) and the "Save/Recall" function. It is reset only by factory preset.
- Disabled  
The instrument preset also deactivates the frequency overrange.

See also [Section 4.4.3, "External RF and I/Q settings"](#), on page 129.

Remote command:

```
[ :SOURCE<hw> ] :FREQUENCY:CONVERTER:EXTERNAL:OVERRANGE [ :STATE ]
```

on page 1208

**Minimal Frequency ← Frequency Overrange**

Displays the minimum frequency value of the connected R&S SZU100A.

Remote command:

```
[ :SOURCE<hw> ] :FREQUENCY:CONVERTER:EXTERNAL:OVERRANGE:FREQUENCY:MIN?
```

on page 1208

**Maximal Frequency ← Frequency Overrange**

Displays the upper frequency value of the connected R&S SZU100A.

Remote command:

```
[ :SOURCE<hw> ] :FREQUENCY:CONVERTER:EXTERNAL:OVERRANGE:FREQUENCY:MAX?
```

on page 1207

**User Variation**

Defines and activates a user-defined step width for varying the RF frequency or RF level with the rotary knob.

If disabled, the step width varies in steps of one unit at the cursor position.

**Variation Active ← User Variation**

Activates the set user-defined step width.

Remote command:

[\[:SOURce<hw>\]:FREQuency:STEP:MODE](#) on page 1206

[\[:SOURce<hw>\]:POWer:STEP:MODE](#) on page 1277

**Variation Step ← User Variation**

Sets the user-defined step width.

Remote command:

[\[:SOURce<hw>\]:FREQuency:STEP\[:INCRement\]](#) on page 1206

[\[:SOURce<hw>\]:POWer:STEP\[:INCRement\]](#) on page 1277

## 8.6 RF level settings

Access:

1. Select "RF" > "RF Level" > "Level".

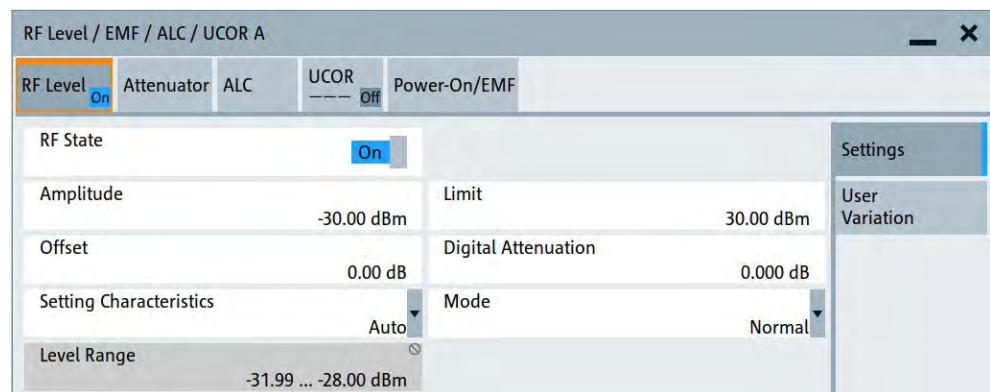

In the "RF Level" dialog, you can configure the offset-free level, the level limit, and the step width for varying the level with the rotary knob.

2. Select "User Variation" to set the step width to be used when setting the RF level using the rotary knob.

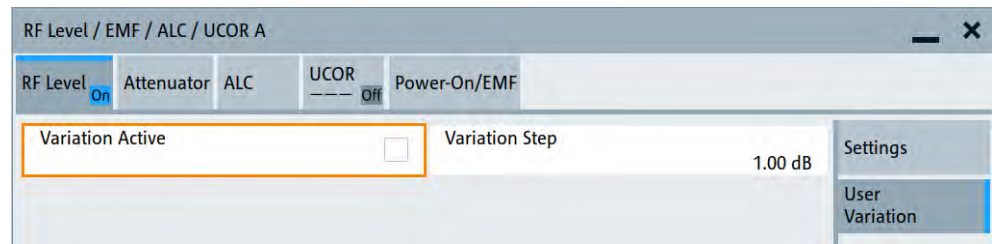

The remote commands required to define the settings are described in [Section 14.19.18, "SOURce:POWer subsystem"](#), on page 1264.

### Settings:

RF State/RF ON.....	486
Amplitude.....	486
Digital Attenuation.....	487
Mode.....	487
Setting Characteristics.....	487
Level Range.....	489
Readjust.....	489
Limit.....	489
Offset.....	489
User Variation.....	490
L Variation Active.....	490
L Variation Step.....	490

### RF State/RF ON

Activates or deactivates the RF output.

Acts as the [RF ON/OFF] key.

Remote command:

`:OUTPut<hw> [:STATe]` on page 945

`:OUTPut:ALL [:STATe]` on page 945

### Amplitude

Sets the level of the RF signal.

The value is offset-free and corresponds to the level at the RF A/RF B connector.

See [Section 8.4.1.1, "Displayed RF frequency and level values with downstream instruments"](#), on page 480.

### Note: Suppressed values in the status bar

For security concerns or certain operating modes, you can hide the frequency and level display in the status bar.

- **\*\*\*\*\***

The display has been disabled for security reasons.

See:

- [Annotation Frequency](#)
- [Annotation Amplitude](#)



The display is disabled when:

- List mode is running, see [Section 8.10, "Varying the RF signal in list or sweep mode"](#), on page 509.
- Digital only signals are generated, see the user manual "R&S SMW-K551 Generation of Digital "Slow IQ" Signals"

Remote command:

`[ :SOURce<hw> ] :POWer:POWer` on page 1273

**Note:** The SCPI command `[ :SOURce<hw> ] :POWer [ :LEVel ] [ :IMMediate ] [ :AMPLitude ]` sets the level of the "Level" display.

This means, the level containing offset.

### Digital Attenuation

Attenuates or raises the level of the internal, digitally modulated I/Q baseband signals, and thus the level of the RF signal accordingly.

The function allows fast level changes of the internal I/Q signals. You can determine an attenuation value between -3 dB and +80 dB. The instrument calculates the digital attenuation to the  $Level_{PEP}$  and the  $Level_{rms}$  as follows:

$$Level_{PEP(RF\ output)} = Level_{PEP} - \text{Digital Attenuation}$$

$$Level_{rms(RF\ output)} = Level_{rms} - \text{Digital Attenuation}$$

The level range changes accordingly.

**Note:** The digital attenuation has no effect on the RF output level when you work in CW mode or with externally applied I/Q signals, i.e. with unmodulated signals. If the digital attenuation effects the RF level, the R&S SMW200A indicates the resulting level in the "Status bar". It is also denoted by an icon next to the level indicator.

Note also that several other parameters affect the displayed RF level value.

See [Section 8.4.1.1, "Displayed RF frequency and level values with downstream instruments"](#), on page 480.

Remote command:

`[ :SOURce<hw> ] :POWer:ATTenuation:DIGital` on page 1270

### Mode

Allows you to optimize the RF output signal for applications, where improved harmonic distortion or improved wideband noise is required.

"Normal" Generates an RF output signal with high signal to noise ratio as well as low distortion.

"Low Noise" Optimizes the signal to noise ratio.

"Low Distortion" Reduces distortion (harmonics) of the RF signal to a minimum.  
For more information, refer to the specifications document.

Remote command:

`[ :SOURce<hw> ] :POWer:LMODe` on page 1271

### Setting Characteristics

Selects additional quality characteristics to optimize the behavior of the RF signal level for the specific application.

"Auto"	<p>Sets the RF output level automatically according to the selected mode.</p> <p>In this mode, the instrument provides the highest dynamic range and fastest setting times.</p> <p>The RF signal is shortly blanked when the step attenuator is switching.</p> <p>For more information, refer to the specifications document.</p>
"Uninterrupted"	<p>Suppresses blanking at level transitions. Frequency transitions can lead to an RF level blanking due to hardware-specific switching points.</p> <p>This mode reduces the dynamic range of the instrument. The step attenuator is fixed.</p> <p><b>Note:</b> Do not enable both the I/Q optimization mode "High Quality" and the RF signal level optimization mode "Uninterrupted" or "Strictly Monotone". The high-quality I/Q optimization mode leads to an RF signal interruption which blocks the RF signal level optimization.</p>
"Strictly Monotone"	<p>Executes signal level changes monotonically increasing or decreasing.</p> <p>The setting makes sure that increasing the level value exclusively results in an increased output level, and vice versa.</p> <p>All electronic switches, which can affect the monotonicity are fixed.</p> <p>The operation mode is useful for applications using level searching algorithms which rely on a strictly monotonous behavior.</p>
"Constant-VSWR"	<p>Suppresses output impedance variations at the RF A/RF B output connector, due to changed level settings.</p>
"Continuous-Phase"	<p>Suppresses phase discontinuities.</p> <p>This mode reduces the dynamic range of the instrument and the step attenuator is fixed (equates to "Strictly Monotone").</p>
"Constant-Phase"	<p>This mode keeps the phase constant by coupling the digital attenuation directly to the level setting.</p> <p><b>Note:</b> The coupling is only active when the I/Q modulator is in operation.</p> <p>Pressing <a href="#">Readjust</a> adds the value of the digital attenuation to the level setting, and sets the <a href="#">Digital Attenuation = 0</a>. In total, the level value remains constant.</p>
"User"	<p>Selects this entry automatically when you change one of the following parameters from the default setting:</p> <ul style="list-style-type: none"> <li>• "Attenuator" &gt; <a href="#">Mode</a></li> <li>• "ALC" &gt; <a href="#">State</a>, <a href="#">Detector Sensitivity</a> or <a href="#">Driver Amplifier</a></li> </ul> <p><b>Note:</b> If you select another setting characteristic, the R&amp;S SMW200A presets the modified attenuator and ALC parameters.</p>



Remote command:

`[ :SOURce<hw> ] :POWER:LBEHaviour` on page 1271

### Level Range

Shows the interruption-free range of the level that you can use in the selected mode.

Remote command:

`:OUTPut<hw>:AFIXed:RANGe:LOWer?` on page 947

`:OUTPut<hw>:AFIXed:RANGe:UPPer?` on page 947

### Readjust

Recalculates and adjusts the internal switch positions of the RF chain according to the current level.

The R&S SMW200A provides the "Readjust" function when you change one of the following parameters from the default setting:

- "RF Level" > [Setting Characteristics](#)
- "Attenuator" > [Mode > FixedSetting Characteristics](#)

In ALC mode "Sample & Hold" or "Sample & On" mode, the function also triggers a new sample process. During the recalculation, the output level is blanked briefly.

Remote command:

`[ :SOURce<hw> ] :POWER:ALC:SONCe` on page 1268

### Limit

Sets an upper limit for the output power.

**Note:** The parameter "RF level" > "**Limit**" and "NRP power control" > "**RF Amplitude Limit**" are identical.

You can use this value to protect your DUT from damage due to high input power. If you enter an RF level above this value, the instrument limits the output power to this specified value, and generates the warning message:

"Pep value greater than the defined limit." However, the level indication in the status bar is not affected.

The setting is not affected by an instrument preset ([PRESET] key or \*RST) and the "Save/Recall" function. It is reset only by factory preset.

Remote command:

`[ :SOURce<hw> ] :POWER:LIMit [ :AMPLitude ]` on page 1271

### Offset

Sets a level offset.

This value represents the level shift of a downstream instrument, like, for example, an attenuator or an amplifier.

The "Level" value displayed in the status bar is the resulting level, as it is at the output of the downstream instrument. The level at the R&S SMW200A RF output is not changed.

See [Section 8.4.1.1, "Displayed RF frequency and level values with downstream instruments"](#), on page 480.

Remote command:

`[ :SOURce<hw> ] :POWER [ :LEVel ] [ :IMMediate ] :OFFSet` on page 1278

**User Variation**

Defines and activates a user-defined step width for varying the RF frequency or RF level with the rotary knob.

If disabled, the step width varies in steps of one unit at the cursor position.

**Variation Active ← User Variation**

Activates the set user-defined step width.

Remote command:

[ :SOURce<hw> ] :FREQuency:STEP:MODE on page 1206

[ :SOURce<hw> ] :POWer:STEP:MODE on page 1277

**Variation Step ← User Variation**

Sets the user-defined step width.

Remote command:

[ :SOURce<hw> ] :FREQuency:STEP [ :INCRe ment ] on page 1206

[ :SOURce<hw> ] :POWer:STEP [ :INCRe ment ] on page 1277

## 8.7 RF phase settings

The phase in sinusoidal signals defines the initial angle at its origin.

Access:

- ▶ Select "RF" > "RF Frequency" > "Phase".

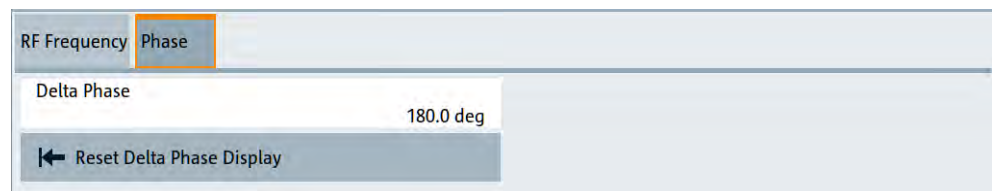

In the "RF Phase" tab, you can determine the delta phase value and reset the phase to this reference.

The remote commands required to define the settings are described in [Section 14.19.17, "SOURce:PHASe subsystem"](#), on page 1263.

**Settings:**

<a href="#">Delta Phase</a> .....	490
<a href="#">Reset Delta Phase Display</a> .....	491

**Delta Phase**

Sets the phase of the RF signal.

The current phase of the signal is used as the reference.

**Note:** Achieving long-term stable phase-locked coupling. We recommend that you use the LO coupling feature, if you try to synchronize the output signal with the phase of a second signal generator for example.

See [Section 8.9, "Local oscillator coupling"](#), on page 500.

Remote command:

[ :SOURce<hw> ] : PHASe on page 1264

#### Reset Delta Phase Display

Adopts the selected "Delta Phase" value as the current value, and resets delta phase to 0 degrees.

Remote command:

[ :SOURce<hw> ] : PHASe:REFeRence on page 1264

## 8.8 Reference oscillator

The R&S SMW200A is equipped with an internal reference oscillator that generates a reference frequency of 10 MHz. It is used as internal reference source for the synthesizer.

Alternatively, you can apply an external reference signal. If equipped with the required options, the R&S SMW200A can process external reference frequency in the range 1 MHz to 100 MHz and the 1 GHz reference frequency.

Regardless of the used reference source (internal or external), the R&S SMW200A always provides the configured reference frequency at the output. You can use it, for example to synchronize several interconnected instruments, see [Section 8.8.5, "Using the reference frequency for instruments synchronization"](#), on page 497, for an overview of typical test situations.



The reference oscillator settings are not affected by an instrument preset ([PRESET] key or \*RST) and the "Save/Recall" function. They are reset only by factory preset.

### 8.8.1 Required options

R&S SMW200A base unit equipped with the following options:

- 100 MHz, 1 GHz ultra low noise reference input and output (R&S SMW-K703)
- 1 MHz to 100 MHz flexible reference input (R&S SMW-K704)

For more information, refer to the specifications document.

### 8.8.2 Reference frequency settings

Access:

1. Select "RF" > "RF Frequency" > "Reference Frequency".

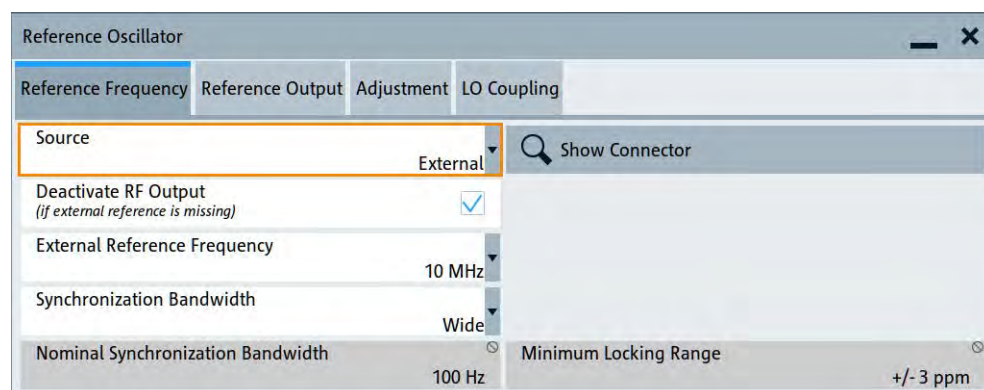

In the "Reference Frequency" tab, you can select the reference frequency signal source and the frequency and synchronization bandwidth mode of an external reference signal.

2. Observe the information in the status bar of the block diagram.

The status bar indicates the current oscillator configuration.



The remote commands required to define these settings are described in [Section 14.19.19, "SOURCE:ROSCillator subsystem"](#), on page 1280.



### Dependencies on RF hardware versions

The supported external reference frequencies depend on the versions of the RF hardware components, the R&S SMW200A is equipped with.

See:

- ["Checking the installed hardware options"](#) on page 1348
- ["Checking the RF hardware assembly"](#) on page 1348
- [Appendix: RF Hardware Versions](#), on page 1397

### Settings:

<a href="#">Source</a> .....	492
<a href="#">Show Connector</a> .....	493
<a href="#">Deactivate RF Output (if external reference is missing)</a> .....	493
<a href="#">External Reference Frequency</a> .....	493
<a href="#">Variable Reference Frequency</a> .....	494
<a href="#">Synchronization Bandwidth</a> .....	494
<a href="#">Nominal Synchronization Bandwidth</a> .....	494
<a href="#">Minimum Locking Range</a> .....	495

### Source

Selects the reference frequency source.

- "Internal" Uses the internal reference oscillator, either with calibrated or a user-defined [Adjustment Value](#).
- Note:** The internal reference frequency automatically uses [Synchronization Bandwidth > Narrow](#). Thus, if you preset this parameter, or set the reference source from "External" to "Internal" manually, the R&S SMW200A sets the bandwidth to "Narrow".
- "External" Uses an external reference signal.
- Note:** If the external reference is missing, the R&S SMW200A issues a warning message and indicates the icon  (external reference missing).
- To set the frequency of the external reference, see "External Reference Frequency".

Remote command:

`[ :SOURce ] :ROSCillator :SOURce` on page 1282



### Show Connector

Accesses a dialog that displays the physical location of the selected connector on the front/rear panel of the instrument.

A blinking LED on the front/rear panel indicates the selected connector, too (see [Section 12.2.2.4, "Status indicators"](#), on page 746).

### Deactivate RF Output (if external reference is missing)

Turns off the RF output when the external reference signal is selected, but no signal is supplied.

This function prevents that no improper RF signal due to the missing external reference signal is used for measurements. A message indicates that the RF output is deactivated.

Remote command:

`[ :SOURce ] :ROSCillator :EXTernal :RFOff [ :STATe ]` on page 1282

### External Reference Frequency

Selects the frequency of the external reference input signal.

The settings depend on the versions of the RF hardware, see [Appendix: RF Hardware Versions, on page 1397](#).

- "10 MHz" 10 MHz external reference frequency
- "100 MHz"/"1 GHz"  
Option: R&S SMW-K703  
Selects the external reference frequency.
- "Variable" Requires R&S SMW-K704.  
The external reference signal has an arbitrary frequency, within the permissible range from 1 MHz to 100 MHz.
- "5 MHz"/"10 MHz"/"13 MHz"  
Option: none (*earlier RF hardware versions*)  
Selects the frequency corresponding to the signal at the reference input.

Remote command:

`[ :SOURce ] :ROSCillator :EXTernal :FREQuency` on page 1282

### Variable Reference Frequency

Requires R&S SMW-K704 and "External Reference Frequency" > "Variable".

Sets a variable value for the external reference frequency.

The settings depend on the versions of the RF hardware, see [Appendix: RF Hardware Versions, on page 1397](#).

For more information, refer to the specifications document.

Remote command:

`[ :SOURce ] :ROSCillator :EXTernal :FREQuency :VARiable` on page 1282

### Synchronization Bandwidth

Selects the synchronization bandwidth for an external reference signal, set with "Source > External".

The resulting bandwidth is indicated by the parameter [Nominal Synchronization Bandwidth](#).

**Note:** If you preset or set the reference source from "External" to "Internal", the R&S SMW200A resets the synchronization bandwidth to "Narrow".

"Narrow"	<p>The internal reference oscillator is synchronized to the external signal with narrow bandwidth.</p> <p>This setting is recommended if the phase noise of the external signal is worse than the phase noise of the internal OCXO.</p>
"Wide"	<p>Synchronizes the internal oscillator to the external signal with the maximum possible bandwidth.</p> <p>This mode is the recommended standard mode and for precise reference sources of high spectral purity.</p> <p><b>Note:</b> If the frequency of the external reference signal is outside the locking range of the internal reference oscillator, spurs due to the difference of the internal and external reference frequency are generated in the reference PLL.</p> <p>The R&amp;S SMW200A issues an error message.</p> <p>For more information, refer to the specifications document.</p>

Remote command:

`[ :SOURce ] :ROSCillator :EXTernal :SBANdwidth` on page 1283

### Nominal Synchronization Bandwidth

Indicates the nominal synchronization bandwidth for the selected external reference frequency and the synchronization bandwidth.

The settings depend on the versions of the RF hardware, see [Appendix: RF Hardware Versions, on page 1397](#).

Remote command:

`[ :SOURce ] :ROSCillator :EXTernal :NSBandwidth?` on page 1284

**Minimum Locking Range**

Indicates the minimum locking range for the selected external reference frequency and the synchronization bandwidth.

The settings depend on the versions of the RF hardware, see [Appendix: RF Hardware Versions, on page 1397](#).

Remote command:

`[ :SOURce ] :ROSCillator :EXTernal :MLRange?` on page 1283

**8.8.3 Reference output settings**

Access:

1. Select "RF" > "RF Frequency" > "Reference Frequency".
2. Select "Reference Output".

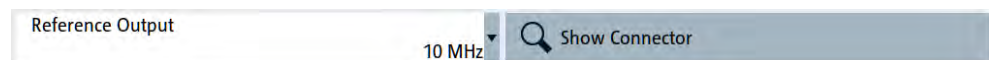

In the "Reference Output" tab, you can set the reference frequency value at the output connectors.

As a result of parameter dependencies, "Preset This Parameter" sometimes does not affect output dialogs.

The remote commands required to define these settings are described in [Section 14.19.19, "SOURce:ROSCillator subsystem"](#), on page 1280.

**Settings:**

<a href="#">Reference Output/1 GHz Reference Output</a> .....	495
<a href="#">Show Connector</a> .....	496

**Reference Output/1 GHz Reference Output**

Selects frequency reference output signal for downstream instruments.

The settings depend on the versions of the RF hardware, see [Appendix: RF Hardware Versions, on page 1397](#).

"Off"	Deactivates the reference signal output.
"10 MHz"	Derives a signal with 10 MHz frequency from the internal reference oscillator and provides this signal at the output.
"100 MHz"	Option: R&S SMW-K703 Provides the 100 MHz reference frequency signal at the output.
"1 GHz"	Option: R&S SMW-K703 Provides the 1 GHz reference frequency signal at the output.
"Input Signal (loop through)"	Option: R&S SMW-K703/-K704 Passes the external reference frequency to the output directly.

"Same As Reference Input"

(*earlier RF hardware versions*)

Passes the assigned reference frequency to the output directly.

"10 MHz Derived From Ref. Output"

(*earlier RF hardware versions*)

Derives a signal with 10 MHz frequency from the reference input and forwards this signal to the output.

Remote command:

`[ :SOURce ] :ROSCillator :OUTPut :FREQuency :MODE` on page 1284



### Show Connector

Accesses a dialog that displays the physical location of the selected connector on the front/rear panel of the instrument.

A blinking LED on the front/rear panel indicates the selected connector, too (see [Section 12.2.2.4, "Status indicators"](#), on page 746).

## 8.8.4 Adjustment settings

Access:

1. Select "RF" > "RF Frequency" > "Reference Frequency".
2. Select "Adjustment".

Adjustment Active <input checked="" type="checkbox"/>	Adjustment Value <input type="text" value="0"/>
---	---

Settings:

<a href="#">Adjustment Active</a> .....	496
<a href="#">Adjustment Value</a> .....	496

### Adjustment Active

Selects the adjustment mode.

"Off" Uses the calibrated internal reference frequency.

"On" Allows you to apply a deviation to the internal reference frequency, according to your requirements.  
Enter the value in the [Adjustment Value](#) field.

Remote command:

`[ :SOURce ] :ROSCillator [ :INTernal ] :ADJust [ :STATe ]` on page 1284

### Adjustment Value

Sets a user-defined adjustment value for the internal reference frequency. This value takes effect when it is activated with [Adjustment Active](#).

- "0" represents the calibrated state.
- The setting range depends on the reference oscillator type and its factory calibration value.



**Note:**

The setting is not affected by an instrument preset ([PRESET] key or \*RST) and the "Save/Recall" function. It is reset only by factory preset.

Remote command:

`[ :SOURce ] :ROScillator [ :INTernal ] :ADJust :VALue` on page 1284

### 8.8.5 Using the reference frequency for instruments synchronization

Test setups with two or more instruments often require that the instruments use a common reference frequency. Depending on the availability of external reference frequency source and its quality, the instruments are connected and configured in different ways.

This section gives an overview of the possible test setups and the related settings. The following situations are considered:

- External reference source is not available or the **built-in reference oscillator** is of better quality than the external source  
(see ["Distributing the internal 10 MHz reference signal to further instruments"](#) on page 497)
- **Clean external reference source** with quality exceeding the quality of the built-in reference oscillator  
(see ["Using external reference source"](#) on page 498)
- **Interfered or noisy external reference signal**  
(see ["Deriving 10 MHz from the external reference frequency"](#) on page 499)
- **1 GHz reference coupling** for phase coherence of the RF signals with enhanced long-term phase stability  
(see ["Sharing the 1 GHz reference frequency to obtain phase-coherent signals"](#) on page 498)

#### Connectors overview

Use the "Show Connector" function to indicate the connector on the front/real panel:

- ["REF IN/REF OUT"](#) on page 48
- 1GHz ["REF IN/REF OUT"](#) on page 48
- ["EFC"](#) on page 49

#### Distributing the internal 10 MHz reference signal to further instruments

The internal reference oscillator provides the reference frequency:

- Internal  $f_{\text{ref}} = 10 \text{ MHz}$  (10 MHz at connector REF OUT)
- [Source](#) = "Internal"
- [Reference Output/1 GHz Reference Output](#) = "10 MHz"

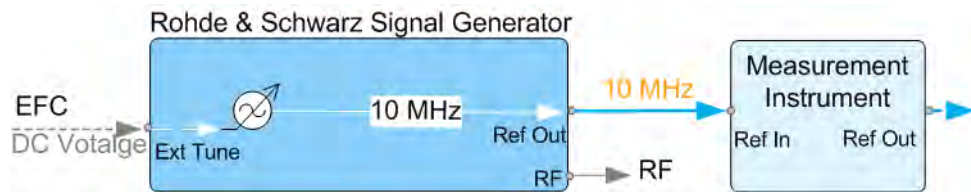

**Figure 8-2: Synchronizing instruments using the internal 10 MHz reference signal of the R&S SMW200A**

EFC = External frequency control  
 EFC, REF IN, REF OUT = Connectors

In phase noise measurement systems, for example, you can also use the EFC (external frequency control) function and shift the frequency. EFC is a function that transforms an external tuning voltage into frequency shift, where the value range of the resulting frequency is a technical characteristic. Further parameters are sensitivity, input voltage range, impedance and maximum bandwidth for external tuning signal.

Consider the following interdependency:

- EFC in combination with an external PLL  
 If the EFC is applied in combination with an external PLL (phase locked loop), the PLL bandwidth must be smaller than the bandwidth of the external tuning signal.
- FM-DC mode  
 If the measurement requires higher PLL bandwidth, we recommend that you use the external FM modulation (DC coupling) in low noise mode.  
 The FM-DC mode yields a fixed tuning sensitivity that is independent of the RF output frequency and corresponds to the selected FM deviation.

For more information, refer to the specifications document.

### Sharing the 1 GHz reference frequency to obtain phase-coherent signals

Compared to 10 MHz, a 1 GHz reference signal significantly improves the achievable phase stability between two signal sources. Because the synchronization frequency increases by a factor of 100, the relative phase fluctuations between the sources can be reduced.

#### 1 GHz at connector REF IN 1GHz and 1 GHz at REF OUT 1GHz

- External  $f_{\text{Ref}} = 1 \text{ GHz}$
- **Source** = "External"
- **External Reference Frequency** = "1 GHz"
- **1GHz Reference Output** = "1 GHz"

#### Using external reference source

If you have a clean external reference signal with 10 MHz or 100 MHz frequency, for example, you can **directly pass it to the output**. The signal quality remains the same.

#### 10 MHz, 100 MHz at connector REF OUT and REF IN

- External  $f_{\text{Ref}} = 10 \text{ MHz}$  or  $100 \text{ MHz}$   
 (earlier RF hardware versions: 5 MHz, 10 MHz, 13 MHz)

- Source = "External"
- Reference Output = "10 MHz, 100 MHz" or "Input Signal (loop through)"  
(earlier RF hardware versions: 5 MHz, 10 MHz, 13 MHz)
- Set the synchronization bandwidth according to the requirements of the application.

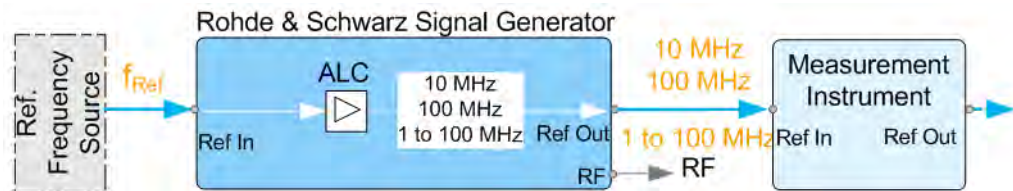

Figure 8-3: Synchronizing instruments with a 10 MHz external reference signal

Ref. Frequency Source = e.g., Rohde & Schwarz signal analyzer

$f_{\text{Ref}}$  = 10 MHz, 100 MHz, 1 MHz to 100 MHz external reference frequency

REF IN, REF OUT = Connectors

You can forward reference frequency between 1 MHz and 100 MHz directly to the output in the same way.

For more information, refer to the specifications document.

- External  $f_{\text{Ref}}$  = 1 MHz to 100 MHz  
(1 MHz to 100 MHz at connector REF IN and REF OUT)
- Source = "External"
- Variable Reference Frequency = "Variable"
- External Reference Frequency = current external frequency
- Reference Output = "Input Signal (loop through)" or specify the reference frequency the synchronized instrument supports
- Set the synchronization bandwidth according to the requirements of the application.

#### Deriving 10 MHz from the external reference frequency

10 MHz reference frequency can be derived from the following external reference signals:

- 10 MHz from internal oscillator locked to external input
- 100 MHz and 1 GHz external reference signals
- External reference signal between 1 MHz and 100 MHz
- If the external reference signal is interfered (noisy)

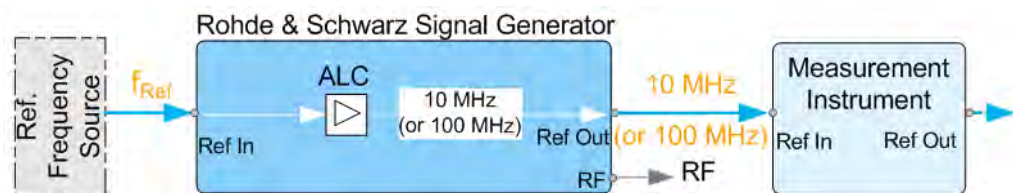

Figure 8-4: Synchronizing instruments with 10 MHz (derived from an external reference frequency)

Ref. Frequency Source = e.g., Rohde & Schwarz signal analyzer  
 $f_{\text{Ref}}$  = 10 MHz, 100 MHz, 1 MHz to 100 MHz, 1 GHz\*\* external reference frequency  
 \*\* = 1 GHz uses REF IN 1 GHz connector  
 REF IN, REF OUT = Connectors

### 1 GHz, 1 MHz to 100 MHz at connector REF IN 1 GHz/REF IN and 10 MHz at REF OUT

- E.g., external Ref.  $f_{\text{ref}}$  = 100 MHz
- **Source** = "External"
- **External Reference Frequency** = "100 MHz"
- **Reference Output/1 GHz Reference Output** = "10 MHz"
- **Synchronization Bandwidth** = "Narrow"

## 8.9 Local oscillator coupling

The local oscillator (LO) coupling function allows a distribution of the local oscillator signal in a way that multiple RF signals can be derived from the same LO signal. Derivation from the same LO signal is mandatory for minimizing the phase fluctuations between these RF signals.

The R&S SMW200A uses either the internal oscillator frequency for the LO signal that is the output signal of the internal synthesizer or an external frequency source. You can select the internal or external LO signal of path A, and optionally couple it with path B. If uncoupled, the path B uses its internal signal. When the LO signal is coupled, the R&S SMW200A indicates the connection line in the block diagram.

### Connectors

- The internal LO signal is output at the LO OUT connector.
- An external signal is fed in at the LO IN connector.

See also ["To locate the LO In/Out connectors"](#) on page 505.

### LO coupling possibilities

You can couple the LO signal as follows:

- **"A Internal & A -> B Coupled"**  
 The R&S SMW200A uses the internal oscillator signal of path A also in path B. The reference frequency settings in path B have no effect and are thus disabled for editing.
- **"A External & A -> B Coupled"**  
 The R&S SMW200A receives an external oscillator signal and uses this signal in both paths. The reference frequency settings in both paths have no effect and are thus disabled for editing.  
 Similarly, you can couple the signals of cascaded instruments as shown in ["To configure LO coupling with cascaded instruments"](#) on page 505.



The instrument cannot verify the frequency of the oscillator signal that is fed in. We recommend that you feed in signal with the same frequency as shown in the settings dialog, see [LO OUT Frequency](#).

### Level adjustment

The level range of the LO input and LO output signal is 10 dBm  $\pm$ 3 dB.

For more information, refer to the specifications document.

The instrument uses the default settings to adjust its internal level, which is sufficiently accurate for most applications. But consider that the oscillator signal level at LO IN is stable, with minimized phase noise and interferences. The fed in signal is directly used in the instrument, and thus affects the instrument performance. We recommend that you keep the harmonics and the subharmonics below -20 dBc, and the level stable within  $\pm$ 0.1 dB over time and temperature.

However, if you need optimum performance, or if you have long interconnections between LO OUT and LO IN, we recommend that you adjust the LO level at the current frequency. Using this function, the instrument optimizes the internal signal levels.

The adjustment takes a few milliseconds.



### LO level adjustments for subsequent instruments

When you perform LO level adjustments in several interconnected signal generators, always start with the first Rohde & Schwarz signal generator, and continue in the order of the following Rohde & Schwarz signal generators. This sequence is necessary, because the second instrument adjusts its internal gain as long as the levels are accurate and then keeps this adjustment untouched. If you change the predecessor, the level of the second signal generator changes and its adjustment is no longer correct.

## 8.9.1 Required options

The equipment layout for using the LO Coupling function is included in:

- Option Phase Coherence (R&S SMW-B90)

## 8.9.2 Phase coherence

Phase coherence of RF signals designates a defined, constant delta phase between two or more RF carrier signals with the same frequency or a multiple of the frequency.

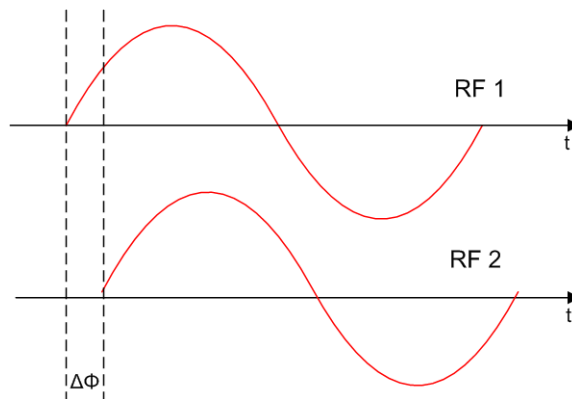

If two signal generators are coupled via their 10 MHz reference, they are generating the same frequency but only from the long term perspective. Having a closer look into the instantaneous differential phase (“delta phase”) of these two RF signals, the following are possible causes for instabilities:

- Phase noise of the two synthesizers
- *Weak* coupling at 10 MHz and a long synthesis chain up to the RF domain
- Temperature differences which cause a change of the effective electrical length of some synthesizer components

Most critical for a stable delta phase is the thermal RF phase fluctuation between multiple RF synthesizers. These fluctuations can be minimized by using a common synthesizer, that means a common local oscillator (LO) signal for all RF carrier. The LO signal is internally used for upconverting the baseband signal to the RF. Only if the LO signal is the same for all carriers, you can achieve a stable phase relationship between the RF signals.

### 8.9.3 LO coupling settings

Access:

- ▶ Select "RF" > "LO Coupling".

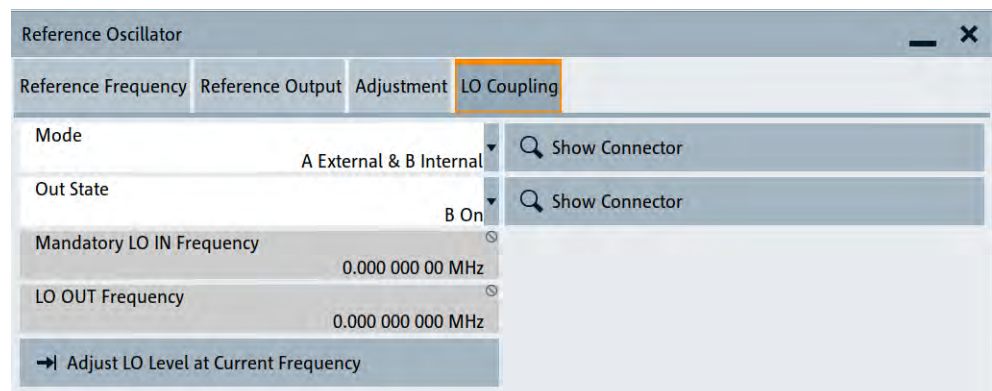

The tab provides settings to configure the coupling of the local oscillator signal in the RF signal paths.

The remote commands required to define these settings are described in [Section 14.19.7, "SOURce:FREQuency subsystem"](#), on page 1197.

### Settings:

Mode.....	503
Out State.....	504
Mandatory LO IN Frequency.....	504
LO OUT Frequency.....	504
Adjust LO Level at Current Frequency.....	504

### Mode

Selects the coupling mode of the LO signals in path A and B.

If you work with a one path instrument, the distinction between A & B and coupling are not relevant. You can select between "Internal" and "External".

See some of typical test setups in [Section 8.9.4, "Configuring cascaded instruments"](#), on page 504.

**Note:** Working with an **external** oscillator signal disables all setting parameters of "RF Frequency / Phase / Ext. Reference" in the corresponding path.

"A&B Internal" Uses the internal local oscillator signal in each path.

"A External & B Internal"

Uses an external signal in path A, and the internal signal in path B.

"A Internal & A -> B Coupled"

Uses the internal oscillator signal of path A in both paths.

"A External & A -> B Coupled"

Uses an external signal in both paths.

"A Internal & B RF Off"

Uses the internal local oscillator signal of path A.

In addition, it enables you to route this LO signal to the LO OUT connector. Thus you can use it as an input signal for a downstream instrument.

The RF output of path B is switched off.

"A External & B RF Off"

Uses an LO input signal for path A.

This setting requires that the applied signal corresponds to the set frequency in path A. You can route the signal to the LO OUT connector and use it as an input for a downstream instrument.

The RF output of path B is switched off.

"A RF Off & B External"

Uses an LO input signal for path B.

This setting requires that the applied signal corresponds to the set frequency in path B. You can route the signal to the LO OUT connector and use it as an input for a downstream instrument.

The RF output of path A is switched off.

"Internal"

Uses the internal signal. This selection parameter applies to one path instruments.

"External" Uses an externally supplied signal. This selection parameter applies to one path instruments.

Remote command:

[\[:SOURce<hw>\]:FREQuency:LOSCillator:MODE](#) on page 1200

#### Out State

Activates or deactivates the LO output.

"B On / On" **Note:** Selection "B On" applies to two-path instruments, and "On" to one-path instruments, respectively.

For coupling two instruments, the internal local oscillator signal is also available at the LO OUT connector.

"Off" The LO output signal is switched off.

Remote command:

[\[:SOURce<hw>\]:FREQuency:LOSCillator:OUTPut:STATe](#) on page 1201

#### Mandatory LO IN Frequency

Displays the frequency that must be applied as external LO frequency.

Remote command:

[\[:SOURce<hw>\]:FREQuency:LOSCillator:INPut:FREQuency?](#) on page 1199

#### LO OUT Frequency

Displays the current LO frequency at the LO OUT connector.

Remote command:

[\[:SOURce<hw>\]:FREQuency:LOSCillator:OUTPut:FREQuency?](#) on page 1201

#### Adjust LO Level at Current Frequency

Adjusts the level of the oscillator signal to optimum, if an external LO signal is applied.

See ["To adjust the LO level to the current frequency"](#) on page 505.

The function is enabled in the following cases:

- An external "LO Coupling Mode" is selected.
- "Out State" is on ("B On" or "On").

**Note:** If your test setup consists of several cascaded Rohde & Schwarz instruments, always use an external oscillator signal and start the LO level adjustment with the first instrument. Continue in the order up to the last.

Remote command:

[:CALibration<hw>:LOSCillator:COUPling:LOCal?](#) on page 922

### 8.9.4 Configuring cascaded instruments

This section describes how you can find out the location of the LO signal connectors (LO In/Out). You can also find instructions for configuring the LO signals of several disconnected signal generators.



### To adjust the LO level to the current frequency

If you are working with an external LO signal, we recommend that you adjust the internal LO level to the optimum value.

To adjust the internal signal level, proceed as follows:

1. In the "LO Coupling" tab, select one of the following:
  - "Mode" > "A External & B Internal"
  - "Mode" > "A External & A-> B Coupled"
  - "Mode" > "External" if you are working with a one path instrument
  - "Mode" > "A External & B RF Off"
  - "Mode" > "A RF Off & B External"
2. Apply the oscillator signal, with a level of 10 dBm  $\pm$ 3 dB at the corresponding LO IN connector.  
See [Section 12.2.4, "RF connectors settings"](#), on page 751.
3. Check if the external oscillator signal has the required frequency, as shown in the dialog under "LO OUT Frequency".
4. Set "Out State > B On".
5. Execute "Adjust LO Level Current Frequency".

The R&S SMW200A automatically adjusts the internal LO signal level at the I/Q modulator and the LO OUT connector.

### To locate the LO In/Out connectors

The LO IN and LO OUT connectors are located on the rear panel. To find out the exact position, proceed as follows:

1. In the block diagram, select the "T/E/P/L/V" status indication field above the "RF" block.
2. Select "LO IN" > "Show".

The connector is on the rear panel.

See also [Section 12.2.4, "RF connectors settings"](#), on page 751.

### To configure LO coupling with cascaded instruments

Use the LO coupling function, for example, to generate beamforming signals. The test setups in the following examples represent possible applications and provide information about the coupling modes set in the signal generators. For the configuration via remote control, see the examples in [Section 14.19.7, "SOURCE:FREQUENCY subsystem"](#), on page 1197.



### Cascading restrictions

In coupled mode or external mode, if you cascade instruments or channels at frequencies below 200 MHz, make sure that the following applies:

- All channels are equipped equally regarding option R&S SMW-B22 that means each channel is equipped with or without the option.
- The connection between the REF OUT of the first instrument and REF IN of the subsequent instrument is established, see [Section 8.8, "Reference oscillator"](#), on page 491.

Frequencies below 200 MHz are generated using downconversion. Therefore the coherence of the cascaded channels in this frequency range is not as good as at higher frequencies.

The first test setup example represents all variants of the coupling modes, and describes step by step how to configure each of the Rohde & Schwarz signal generators. The following examples show further conceivable test setups. To configure these test setups, proceed similarly as shown in the first example.

### Example: Cascading three Rohde & Schwarz signal generators

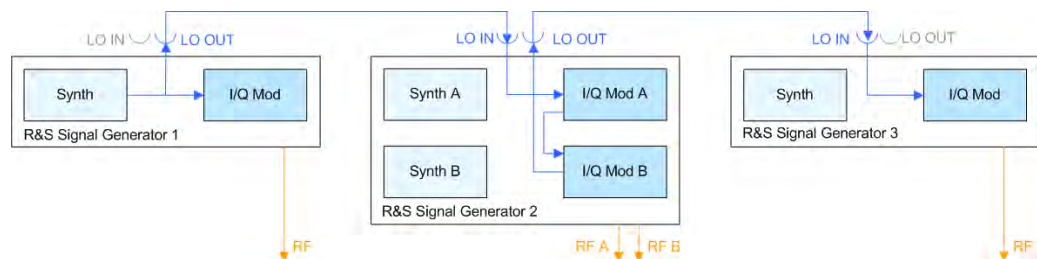

**Figure 8-5: Set up of LO coupling with three Rohde & Schwarz Signal Generators**

Generator 1 = "Internal"; "LO OUT" > "On"

Generator 2 = "A External & A->B Coupled"; "LO OUT" > "On"

Generator 3 = "External"; "LO OUT" > "Off"

A frequency of 5 GHz is assumed.

- Signal Generator 1 is a one-path instrument, for example R&S SMW200A and uses its internal oscillator signal.
- Signal Generator 2 is a two-paths instrument, for example an R&S SMW. It receives the LO signal from the first instrument and assigns it to both paths.
- Signal Generator 3 is a one-path instrument, for example the R&S SMW200A or the R&S SGT100A. It receives the LO signal from the second instrument.

To configure the application, proceed as follows:

1. Connect the first signal generator REF OUT with LO IN of the second instrument, and similarly the LO OUT of the second signal generator with LO IN of the third.
2. Configure **Signal Generator 1**.  
Set the frequency "Freq" = "5 GHz".
  - a) Select "RF" > "LO Coupling" > "Mode" > "Internal".

- b) Set "Out State" > "On".
3. Configure **Signal Generator 2**.
- a) Set the frequency "Freq" = "5 GHz".
- b) Select "RF" > "LO Coupling" to check if both paths are able to deal with the desired RF frequency.
- If both paths can handle the RF frequency, select "Mode" > "A External & A->B Coupled"
  - If path A is not sufficiently equipped, select "Mode" > "A RF Off & B External"
  - If path B is not able to handle the frequency, select "Mode" > "A External & B RF Off"
- c) Set "Out State" > "On".
- d) If the attenuation between the interconnection LO OUT and LO IN is more than 1 dB at the oscillator frequency, we recommend that you execute "Adjust LO Level Current Frequency".
- Note:** Complete the adjustment procedure before you perform the adjustment on a subsequent instrument.  
The signal generator automatically adjusts the internal LO signal level at the I/Q modulator and LO OUT connector.
4. Configure **Signal Generator 3**.
- a) the frequency "Freq" = "5 GHz".
- b) Select "RF" > "LO Coupling" > "Mode" > "External".
- c) Set "Out State" > "Off".
- d) If the attenuation between the interconnection LO OUT and LO IN is greater than 1 dB at the oscillator frequency, we recommend that you perform level adjustment:
- Check if the "Adjust LO Level Current Frequency" procedure of the previous instrument is completed.
  - Execute "Adjust LO Level Current Frequency".
- The signal generator automatically adjusts the internal LO signal level at the I/Q modulator and LO OUT connector.

All instruments generate the RF signals in phase, as they use the same oscillator signal looped through all instruments.

**Example: Generating a beamformed signal (single path instruments)**

This example shows a test setup with two single-path Rohde & Schwarz generators.

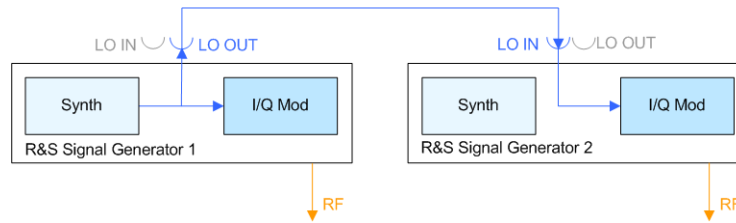

Generator 1 = "Internal"; "LO OUT" > "On"  
 Generator 2 = "External"; "LO OUT" > "Off"

The *Signal Generator 1* uses its internal oscillator signal. *Signal Generator 2* receives the LO signal from the first instrument. The frequency is assumed to be 2 GHz.

**Example: Generating a beamformed signal (dual path instruments)**

This example shows a test setup with two dual-path generators, for example the R&S SMW200A.

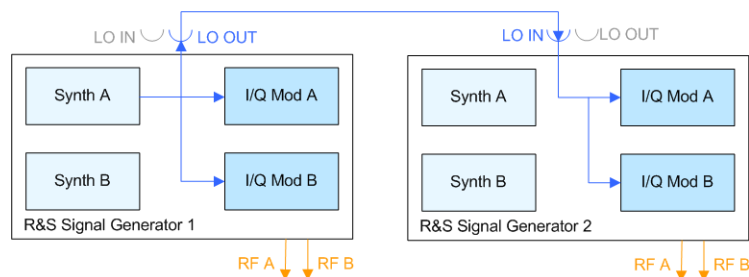

**Figure 8-6: Set up of LO coupling with two Rohde & Schwarz Signal Generators**

Generator 1 = "A Internal & A->B Coupled"; "LO OUT > On"  
 Generator 2 = "A External & A->B Coupled"; "LO OUT > Off"

The signal generator 1 uses the internal oscillator signal of path A also in path B. The signal generator 2 receives the LO signal from the first instrument and assigns it to both paths. The frequency is assumed to be 2 GHz.



Depending on the required RF frequency, your instrument may not be adequately equipped in one of the paths.

If so, you can adjust the LO coupling mode accordingly to use the LO signal from the other path. Proceed as described in [Configure Signal Generator 2 in the example "Cascading three Rohde & Schwarz Signal Generators"](#).

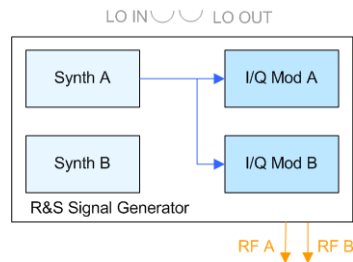
**Example: Generating a beamformed signal with one R&S SMW200A**

Generator = "A Internal & A->B Coupled"; "LO OUT" > "Off"

The R&S SMW200A uses its internal oscillator signal in both paths and outputs the signal at the LO OUT connector. The frequency is 5 GHz.

## 8.10 Varying the RF signal in list or sweep mode

The operating modes "List" and "Sweep" allow you to generate an RF signal having periodically varying frequencies or amplitudes.

A signal generated with varying parameters scans a certain range of varying values of a parameter, with defined start and end points, and can be repeated cyclically.

The R&S SMW200A supports two basic methods:

- **Sweep** mode

The instrument generates an RF signal which varies its frequency or level values in discrete steps between the start and end values. The values change according to a specific shape like sawtooth or triangle. The spacing is linear or logarithmic.

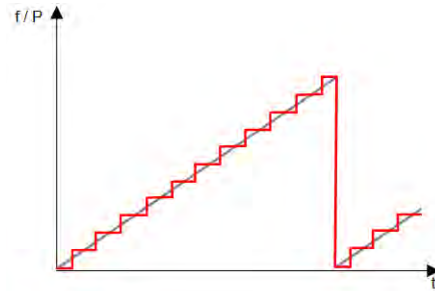

*Figure 8-7: Schematic representation of a signal generated in sweep mode*

The main application field of the "Sweep" mode is to determine the frequency response of a DUT.

- **List** mode

The instrument generates a varying output signal, based on a previously saved list with frequency, amplitude and step width values. While in sweep mode the frequency **or** the level values change, in list mode you can vary **both parameters simultaneously**. The frequency and level values do not need to have ascending or descending order, they can vary arbitrarily.

You can use a global dwell time, which means that the time interval is constant for all steps of the list, or different dwell times for each value pair.

Figure 8-8 represents the frequency and power value pairs, in this case with the dwell time set the same for all steps (global dwell time).

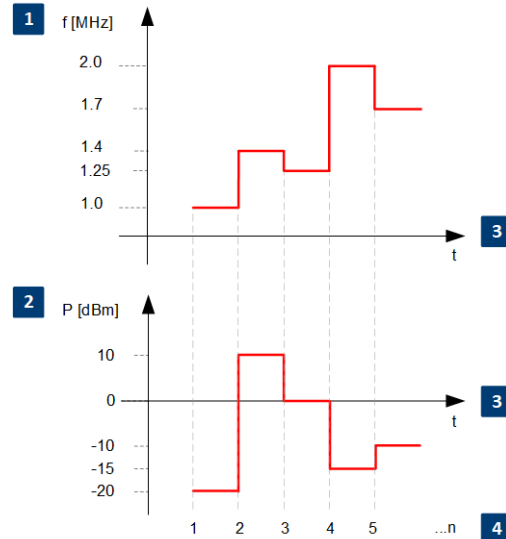

Figure 8-8: Schematic representation of a signal generated in list mode (global dwell time)

- 1 = RF frequency
- 2 = RF Level
- 3 = Dwell time (global)
- 4 = List index

The list mode is especially useful in high-speed measurements with fast changing frequency and level settings.



Note that the shown diagrams represent the behaviour in theory. In real signal generation, the instruments usually have a blank time when the frequency or level changes.

### Interactions and characteristics of list and sweep mode

- Activating the list mode automatically deactivates all RF and LF sweeps and vice versa.
- In list processing mode, the frequency and level display in the status bar is disabled.

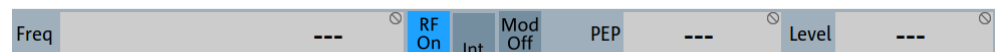

- The sweep modes only work with a *global* dwell time, that means the time intervals are constant during signal generation.
- If you want to hold a running sweep at a specific frequency or level value, enter the value in the status bar. The sweep stops immediately.
- We recommend that you switch off the display update for optimum sweep performance, especially with short dwell times  
See [Section 12.1.3, "Display update settings"](#), on page 739.

**I/Q modulation and list mode in path B depends on frequency options**

If the instrument is equipped with one of the frequency options R&S SMW-B2012 or higher frequency options (R&S SMW-B212/-B220 for earlier RF hardware versions) in path B, and you are generating an I/Q modulated signal, the list processing mode is blocked in this path.

### 8.10.1 Signal generation and triggering in the sweep and list modes

In both operating modes "List" and "Sweep", triggering and signal generation follow the same principle. The instrument generates the signal continuously (that means triggered automatically) or in individual steps (controlled manually by an internal or external trigger signal).

The instrument expects the trigger signal at the INST TRIG x connector.



If the dwell time in sweep or list mode is too short or external trigger signals come too fast, the signal generation delays. As the delay increases, the R&S SMW200A signals an overrun, or even stops sweep or list mode signal generation, if the delay gets too long.

The instrument displays corresponding error messages.

The figures in this section give an overview on the signal generation in the sweep and list modes and the appropriate triggering. The figures show the signal state after activating the mode and the generation of the signal when a trigger event occurs. For each mode, the relevant parameters and settings are briefly explained.

Each "Sweep" and "List" mode dialog provides also a "Reset" function that sets the signal to the initial value or the beginning of the list. Depending on the selected trigger mode, the signal generation proceeds accordingly.



The naming of the selection parameters in manual control (GUI) sometimes deviates from the naming in the remote-control commands. In addition, the value names of the selection parameters used in the signal generator partly differ from the SCPI syntax. The instrument accepts all value names.

The correlation between the manual control and the corresponding remote control commands, including the SCPI conform syntax are explained for each mode (see the cross-reference tables).

See also the following programming examples on the sweep and list modes in remote control:

- [Example "Setup an RF frequency or power sweep"](#) on page 1288
- [Example "Setup an LF sweep"](#) on page 1227
- [Example "Create an RF list and activate the list mode"](#) on page 1240

## Auto mode (Sweep/List)

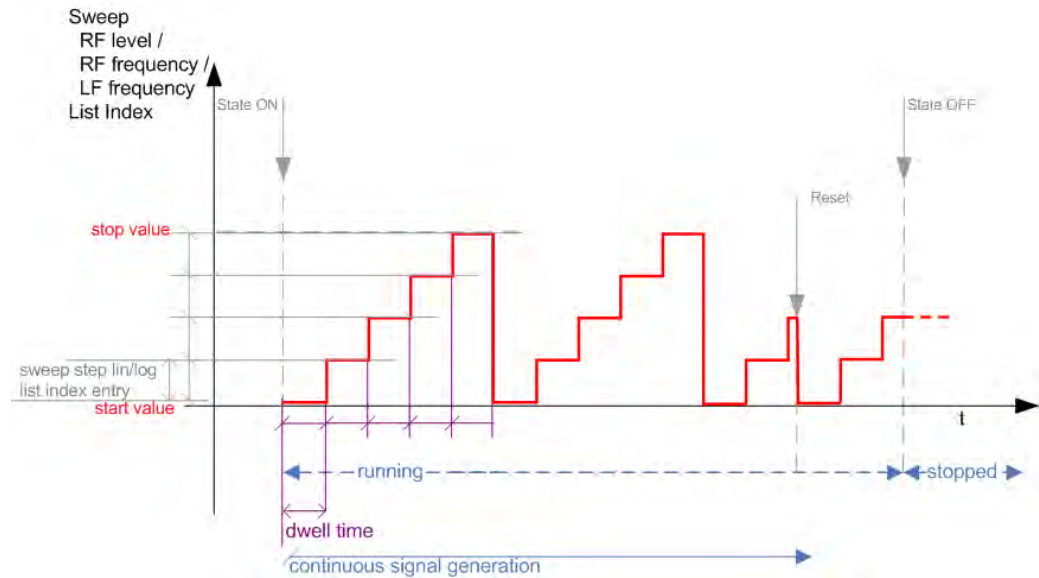

Figure 8-9: Auto mode (Sweep/List)

- The instrument generates the signal continuously.
- Trigger mode "Auto" is prerequisite (default). It causes the continuous generation of the sweep signal.
- Starts signal generation immediately with "State = On".
- Switches automatically to the next step when the **Dwell time** has elapsed.
- Stops signal generation with "State = Off".

Table 8-2: Cross-reference between manual and remote control in Auto mode (Sweep/List)

Manual control mode: "Auto"	Remote commands Rohde & Schwarz proprietary and [SCPI conform] value name
RF frequency sweep	:TRIGger<hw>:FSweep:SOURce AUTO [IMMediate] :SOURce<hw>:SWEep:FREQuency:MODE AUTO
RF level sweep	:TRIGger<hw>:PSweep:SOURce AUTO [IMMediate] :SOURce<hw>:SWEep:POWer:MODE AUTO
LF frequency sweep	:TRIGger<hw>:LFFSweep:SOURce AUTO [IMMediate] :SOURce<hw>:LFOutput<ch>:SWEep:FREQuency:MODE AUTO
List	:SOURce<hw>:LIST:MODE AUTO :SOURce<hw>:LIST:TRIGger:SOURce AUTO



### Single / Extern Single mode (Sweep/List)

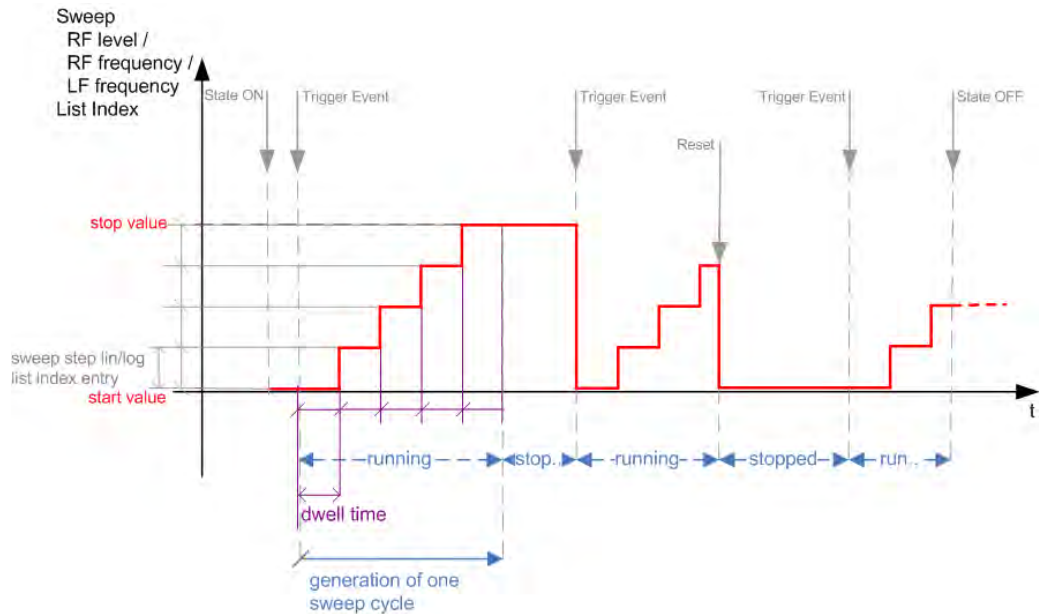

Figure 8-10: Single / Extern Single mode (sweep / list)



In single mode, you can specify, that the signal returns to the start value when a sweep cycle has been completed.

See "[The Retrace function](#)" on page 518 for details.

- The instrument generates a single sweep cycle.
- Trigger mode "Manual". A trigger event initiates one sweep from the start value to the end value.
- "State = On" sets the signal to the start value: the sweep start frequency, the sweep start power or the frequency-power value pair of the selected index in the list.
- Starts signal generation with a trigger event.
- Switches automatically to the next step when the [Dwell time](#) has elapsed.
- Stops signal generation at the set end value and waits for the subsequent trigger event.
- Trigger sources:
  - The corresponding remote control command.
  - An externally applied trigger signal.
- "State = Off" stops the signal generation in sweep or list mode.

**Table 8-3: Cross-reference between manual and remote control in Single / Extern Single modes (Sweep/List)**

Manual control mode: "Single / Extern Single"	Remote commands Rohde & Schwarz proprietary and [SCPI conform] value name
RF frequency sweep	:TRIGger<hw>:FSWEEP:SOURce SINGLE [BUS] "Single" or :TRIGger<hw>:FSWEEP:SOURce EXTERNAL [EXTERNAL] "Extern Single" :SOURce<hw>:SWEep:FREQuency:MODE AUTO
RF level sweep	:TRIGger<hw>:PSWEEP:SOURce SINGLE [BUS] for "Single" or :TRIGger<hw>:PSWEEP:SOURce EXTERNAL [EXTERNAL] for "Extern Single" :SOURce<hw>:SWEep:POWer:MODE AUTO
LF frequency sweep	:TRIGger<hw>:LFFSWEEP:SOURce SINGLE [BUS] "Single" or :TRIGger<hw>:LFFSWEEP:SOURce EXTERNAL [EXTERNAL] "Extern Single" :SOURce<hw>:LFOuTput<ch>:SWEep:FREQuency:MODE AUTO
List	:SOURce<hw>:LIST:TRIGger:SOURce SINGLE "Single" or :SOURce<hw>:LIST:TRIGger:SOURce EXTERNAL "Extern Single" :SOURce<hw>:LIST:MODE AUTO

### Step / Extern Step mode (Sweep/List)

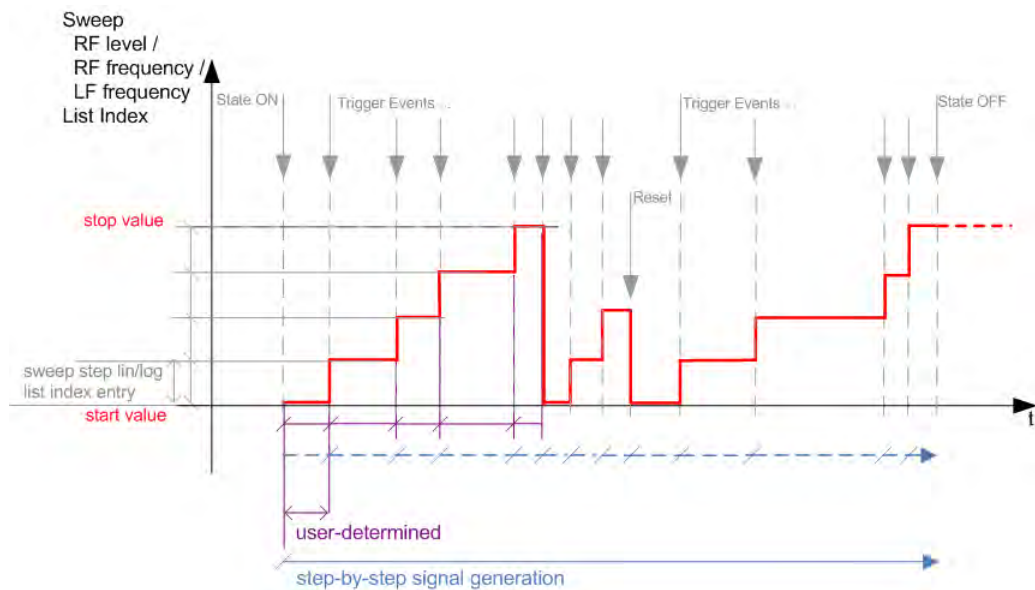

**Figure 8-11: Step / Extern Step mode (sweep / list)**

- The instrument generates the signal step-by-step.
- Starts signal generation with "State = On".
- Switches to the next step with a manual action.  
If the end value is reached, signal generation starts again from the beginning.
- Stops signal generation with "State = Off".

- Trigger sources:
  - The rotary knob at the front panel.
  - The [Arrow] keys at the front panel.
  - The corresponding remote control commands.
  - An externally applied trigger signal.

To step through the sweep frequencies or levels:

- In manual mode:
  - Set the [Current Frequency](#) or [Current Level](#) values
  - Use the [Up] and [Down] keys or the rotary knob
- In remote control mode:
  - Use the commands `[ :SOURCE<hw> ] :FREQUENCY:MANual` or `[ :SOURCE<hw> ] :POWER:MANual` with the UP or DOWN parameter



Steps that would exceed the sweep range are ignored.

**Table 8-4: Cross-reference between manual and remote control in Step / Extern Step modes (Sweep/ List)**

Manual control mode: "Step / Extern Step"	Remote commands Rohde & Schwarz proprietary and [SCPI conform] value name
RF frequency sweep	:TRIGger<hw>:FSweep:SOURce SINGLE [BUS] "Step" or :TRIGger<hw>:FSweep:SOURce EXTernal [EXTenal] for "Extern Step" :SOURCE<hw>:SWEep:FREQUENCY:MODE STEP
RF level sweep	:TRIGger<hw>:PSweep:SOURce SINGLE [BUS] "Step" or :TRIGger<hw>:PSweep:SOURce EXTernal [EXTenal] "Extern Step" :SOURCE<hw>:SWEep:POWER:MODE STEP
LF frequency sweep	:TRIGger<hw>:LFFSweep:SOURce SINGLE [BUS] "Step" or :TRIGger<hw>:LFFSweep:SOURce EXTernal [EXTenal] "Extern Step" :SOURCE<hw>:LFOutput<ch>:SWEep:FREQUENCY:MODE STEP
List	:SOURCE<hw>:LIST:TRIGger:SOURce SINGLE "Step" or :SOURCE<hw>:LIST:TRIGger:SOURce EXTernal "Extern Step" :SOURCE<hw>:LIST:MODE STEP

**Extern Start/Stop mode (sweep)**

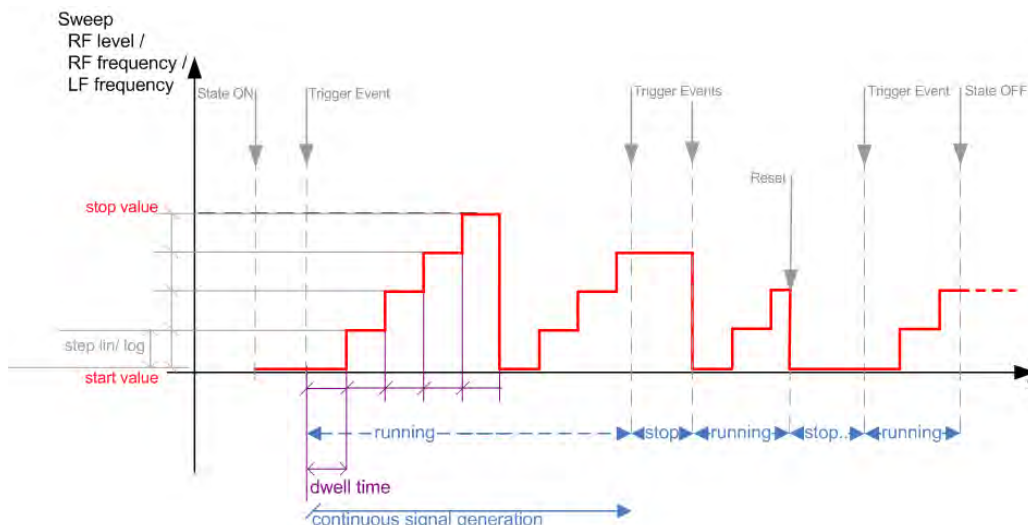

**Figure 8-12: Extern Start/Stop mode (sweep)**

- The instrument generates the signal continuously.
- Trigger mode "Auto" and "Sweep > State = On" are prerequisite.
- State "On" sets the signal to the start value, that is one of the following:
  - Sweep start frequency
  - Sweep start power
  - Frequency-power value pair of the selected index in the list
- Starts signal generation with a trigger event.
- Switches automatically to the next sweep step when the **Dwell time** has elapsed. If the end value is reached, signal generation continues with the next sweep cycle.
- Stops signal generation with the next external trigger event.
- Starts the signal generation again with the next trigger event, beginning at the start value.
- "State = Off" stops the signal generation in sweep or list mode.
- Trigger source: An externally applied trigger signal.

**Table 8-5: Cross-reference between manual and remote control in Extern Start/Stop modes (sweep)**

Manual control mode: "Extern Start/Stop"	Remote commands Rohde & Schwarz proprietary and [SCPI conform] value name
RF frequency sweep	:TRIGger<hw>:FSweep:SOURce EAUTO [-] :SOURce<hw>:SWEep:FREQuency:MODE AUTO
RF level sweep	:TRIGger<hw>:PSweep:SOURce EAUTO [-] :SOURce<hw>:SWEep:POWer:MODE AUTO
LF frequency sweep	:TRIGger<hw>:LFFSweep:SOURce EAUTO [-] :SOURce<hw>:LFOutput<ch>:SWEep:FREQuency:MODE AUTO

### Manual mode (Sweep/List)



The **manual** mode only applies to remote control. It is not visible in the graphical user interface of the instrument and is described here for completeness.

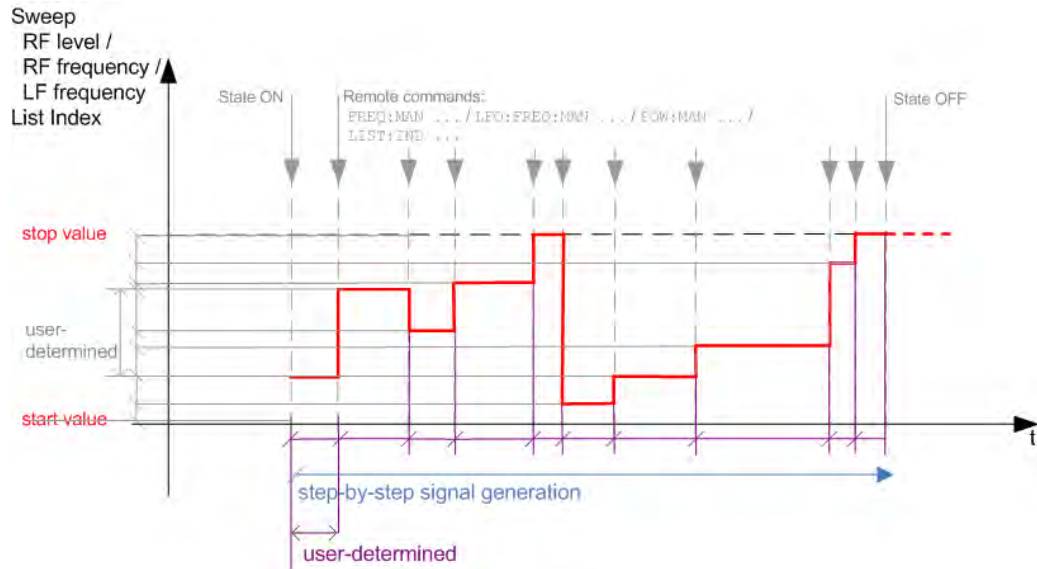

**Figure 8-13: Manual mode in remote control (sweep / list)**

- The instrument generates the signal in steps.
- Starts signal generation with "State = On".
- Switches to the next step with a user defined setting via remote control. You can arbitrarily select a value within the range of the start and stop values by setting the frequency, power or index using the corresponding remote control command. There is no ascending or descending order.
- Stops signal generation with "State = Off".

**Table 8-6: Remote control commands in manual mode (Sweep/List)**

Remote control mode:	Remote commands
Manual	Rohde & Schwarz proprietary and [SCPI conform] value name
RF frequency sweep	:SOURce<hw>:FREQUency:MANUal <Manual>
RF level sweep	:SOURce<hw>:POWER:MANUal <Manual>
LF frequency sweep	:SOURce<hw>:LFOUtput:FREQUency:MANUal <Manual>
List	:SOURce<hw>:LIST:INDex <Index>

### The Retrace function

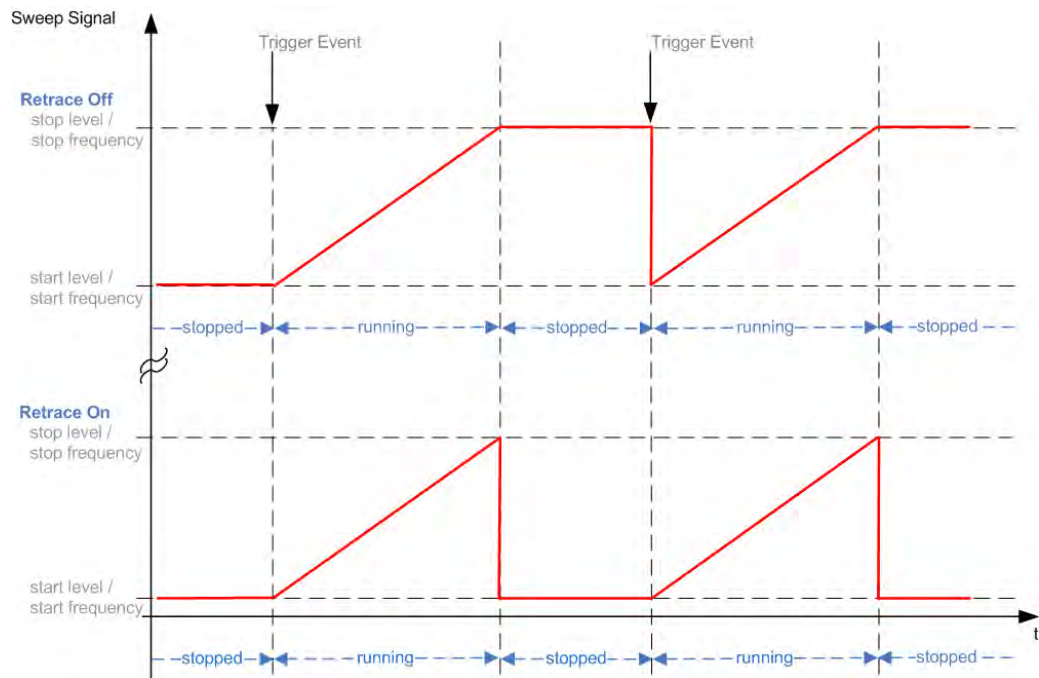

Retrace is a function especially designed for "Single" sweep modes, when the sweep signal follows a sawtooth shape. Working in this mode, the instrument performs a single sweep cycle when a trigger event occurs. The signal generation stops at the set end point (stop frequency or stop level), and waits for the next trigger event.

In this state, the upper value of the signal remains at the output until the next cycle starts. In particular, if you generate a level sweep signal, the high amplitude of the signal is output for a certain time. To protect the DUT from overload, the retrace function immediately resets the signal value to the start value at the end of a sweep cycle. It returns to the start level or start frequency until the next trigger is applied.

You can use the "Retrace" function if "Sweep > Mode = Single/External Single" and "Shape = Sawtooth", see:

- "Shape" on page 528
- "Mode" on page 528

### 8.10.2 About sweep mode

In sweep mode, the signal generator scans the sweep range gradually from one point to another, using a defined step size and following a triangle or sawtooth shape. This mode also enables you to change direction, that means, it is possible to step backwards.

See [Section 8.10.2.2, "Sweep signal shapes"](#), on page 521.

### Configuration and operation of sweep mode signals

- The R&S SMW200A generates a sweep signal by varying either the *RF frequency*, the *RF level* or the *LF frequency*.
- In all sweep modes, you can perform a complete sweep cycle once, repeat the cycle continuously or step through it gradually.
- The instrument generates the sweep signal according to the sweep settings.
- The "Reset Sweep" function, provided in the sweep settings dialogs enables you to reset the sweep to its initial value and restart it.



### Impact of changing the sweep mode during performance

If you change the sweep mode during the execution, the signal generator stops the sweep and starts with the next trigger event at the initial value.

#### 8.10.2.1 Correlating parameters in sweep mode

A sweep signal is a periodic signal that changes its frequency or level, or both, from a starting value to an ending value in a defined time.

The R&S SMW200A provides various possibilities to configure a sweep signal. For example, you can determine the sweep range by the start and end values, or based on the start value and span. In any case, related parameters are adjusted accordingly.

The formulas below show how the sweep parameters correlate and the corresponding calculation basis, by the frequency and offset settings. Apart from "Center Frequency", "Span" and "Step\_lin", the values apply accordingly to the level settings.

**Table 8-7: Variables that are used in the following formulas**

Variable	Description
Sweep range	Defined frequency or level value range
$f_{\text{CENTer}}$	Defined center frequency
$f_{\text{SPAN}}$	Defined extend of the sweep range
$f_{\text{OFFSet}}$	Frequency offset
$f_{\text{START}}$	Start frequency of the sweep range
$f_{\text{STOP}}$	End frequency of the sweep range
$f_1$	Current sweep frequency
$f_2$	Next, subsequent sweep frequency
step_lin	Step size in linear scaling
step_log	Step size in logarithmic scaling
POINTS	Number of steps within the sweep range

### Sweep range

The sweep range is defined by a start and an end value. How the remaining parameters correlate is shown below.

#### Offset = 0

Sweep Range =  $f_{\text{START}}$  to  $f_{\text{STOP}}$

$$f_{\text{CENTer}} = (f_{\text{START}} + f_{\text{STOP}})/2$$

$$f_{\text{SPAN}} = (f_{\text{STOP}} - f_{\text{START}})$$

Where:

$$f_{\text{START}} = f_{\text{CENTer}} - (f_{\text{SPAN}}/2)$$

$$f_{\text{STOP}} = f_{\text{CENTer}} + (f_{\text{SPAN}}/2)$$

#### Offset≠0

A defined offset also affects the sweep range and the center frequency. Therefore, the set frequencies are only absolute values, if the Offset = 0. Offset ≠ 0 shifts the frequencies with the offset value:

Sweep Range =  $f_{\text{START}} + f_{\text{OFFSet}}$  to  $f_{\text{STOP}} + f_{\text{OFFSet}}$

$$f_{\text{CENTer}} = f_{\text{CENTer}} + f_{\text{OFFSet}}$$

$$f_{\text{SPAN}} = f_{\text{SPAN}} + f_{\text{OFFSet}}$$

The value range of the instrument is calculated as follows:

$$RF_{\text{min}} + f_{\text{OFFSet}} \text{ to } RF_{\text{max}} + f_{\text{OFFSet}}$$



It is possible to set  $f_{\text{START}} > f_{\text{STOP}}$  and  $f_{\text{START}} < f_{\text{STOP}}$ , so that even a negative value is permitted for the "Span".

If you change the start and/or stop frequency, the span and center frequency change accordingly, and vice versa.

### Sweep steps

In the following, you see how the sweep steps are calculated depending on the defined spacing mode. The formulas show a frequency sweep, but apply to the level settings in the same way.

The step size is added to the current value, to get the subsequent sweep step.

With **linear** scaling, the next frequency is calculated according to:

$$f_2 = f_1 + \text{step\_lin}$$

In the **logarithmic** scaling, the step size is determined in per cent, as a constant fraction of the current frequency.

Successive frequencies are calculated as follows:

- For  $f_{\text{START}} < f_{\text{STOP}}$   

$$f_2 = f_1 * (1 + \text{step\_log}/100)$$



If  $f_2 > f_{STOP}$ , then  $f_2 = f_{STOP}$

- For  $f_{START} > f_{STOP}$   
 $f_2 = f_1 / (1 + \text{step\_log}/100)$   
 If  $f_2 < f_{STOP}$ , then  $f_2 = f_{STOP}$

With "Shape = Triangle", the frequency values on the slope from  $f_{STOP}$  to  $f_{START}$  are the same as on the slope from  $f_{START}$  to  $f_{STOP}$ .

If you specify the number of steps within the sweep range, the step size is adjusted according to the following correlation:

- For **linear** sweeps and  $f_{START} < f_{STOP}$   
 $\text{POINTS}_{\text{frequency}} = ((f_{START} - f_{STOP})/\text{step\_lin}) + 1 = (f_{SPAN}/\text{step\_lin}) + 1$
- For **logarithmic** sweeps and  $f_{START} < f_{STOP}$   
 $\text{POINTS}_{\text{frequency}} = ((\log f_{STOP} - \log f_{START})/\log \text{step\_log}) + 1$

If step\_log changes, the value of POINTs is adjusted. The  $f_{START}$  and  $f_{STOP}$  values are retained.

### 8.10.2.2 Sweep signal shapes

The R&S SMW200A supports the following sweep shapes:

- **Sawtooth**  
 The sweep sequence resembles a sawtooth. One sweep runs from start to stop frequency, or level value respectively. Each subsequent sweep starts again at the start value.

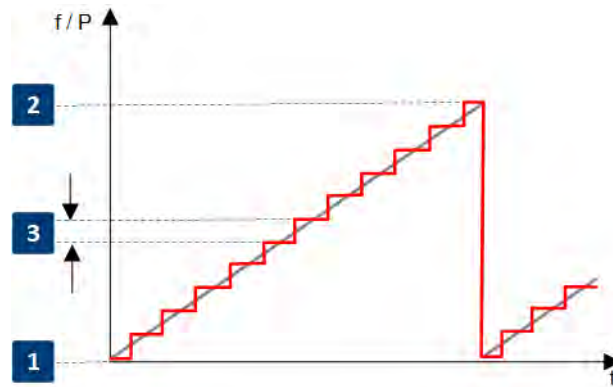

**Figure 8-14: Sweep signal sawtooth shape**

1 = Start value  
 2 = Stop value  
 3 = Step size

- **Triangle**  
 The sweep sequence resembles a triangle. One sweep runs from start to stop value frequency and back. Each subsequent sweep starts at the start value.

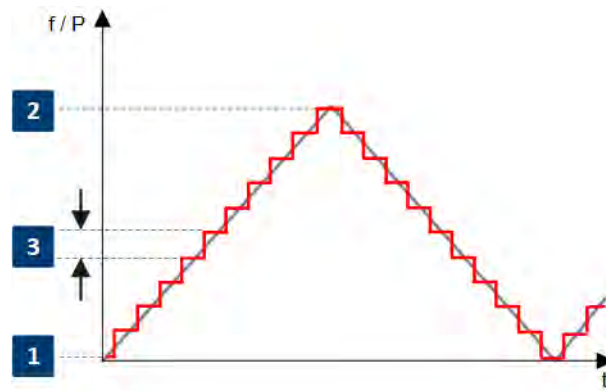

Figure 8-15: Sweep signal triangle shape

- 1 = Start value
- 2 = Stop value
- 3 = Step size

The current frequency or level of an RF frequency, level or LF frequency sweep is determined by the shape (e.g. sawtooth or triangle) and the spacing (linear or logarithmic), and the step size.

### 8.10.3 About list mode

The list mode is used to generate the RF signal based on a set of predefined frequency and amplitude value pairs, with individual step times. You can define the values arbitrarily, in any order and varying step sizes, within the entire configurable value range of the instrument.

#### Configuration and operation of list mode signals

The parameters configuring the RF signal are defined in a list (table) and stored in a file.

#### Creating and handling lists

List files can be created in the following ways:

- **Internally**
  - Use the build-in table editor with columns for the frequency-level values pairs and the dwell time.
  - Define the values manually (row by row) or automatically, based on value range and step size.
  - See [Section 8.10.7, "List data editor"](#), on page 542.
  - Lists are saved as files with user-definable filename and the predefined file extension \*.lsw. To load a saved file, use the "File Manager".
  - See [Section 11.8, "Using the file manager"](#), on page 719.
- Lists can be exported, too. For example, to exchange configuration between instruments or to modify the file content with an external program and reload them again.
- **Externally**

Create a list file as a CSV file with Microsoft Excel, with a Notepad or a similar tool and save it with the predefined extension. Transfer the file to and load it into the instrument.

### Dwell time mode

You can choose whether you want to use different dwell times or a fixed value for all steps in the list mode:

- "From List"  
This mode uses the values from the data table.  
See [Section 8.10.7, "List data editor"](#), on page 542.
- "Global"  
This mode processes the list with a fixed time interval you can set with [Global Dwell Time](#).

### List processing mode

The R&S SMW200A generates signals from list files in two modes, "Live" and "Learned (Frozen RF Settings)". These modes differ in terms of signal quality, signal processing and switching time.

For details, see:

- ["Learn List Mode Data list processing mode"](#) on page 524
- ["Live list processing mode"](#) on page 525

## 8.10.4 Significant parameters and functions

This section provides some basic parameters, settings and functions that affect the operating modes CW, list and sweep, that means at all frequency and level transitions of the RF signal.

### Dwell time

Dwell time is the length of time that elapses from the beginning until the end of a step in list or sweep mode.

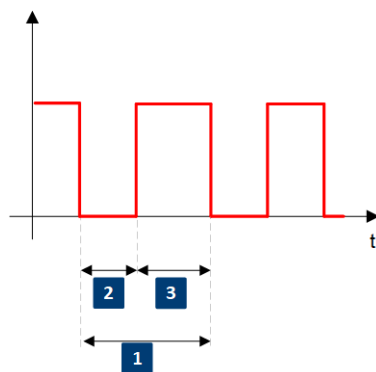

Figure 8-16: Dwell Time vs. settling time

- 1 = "Dwell Time" (as set with the parameter)
- 2 = Settling time
- 3 = Dwell time (effective)

However, the time the instrument requires for the signal to settle reduces the set dwell time:

$$t_{\text{dwell(effective)}} = t_{\text{dwell}} - t_{\text{settling}}$$



If the dwell time in sweep or list mode is too short or external trigger signals come too fast, the signal generation delays. As the delay increases, the R&S SMW200A signals an overrun, or even stops sweep or list mode signal generation, if the delay gets too long.

The instrument displays corresponding error messages.

### Hardware adjustments

The first time a list (new or modified) is processed, the instrument automatically calculates the necessary hardware settings. It can be performed during list processing, but delays the first cycle, especially with short dwell times.

With long dwell times, you can perform this calculation while the list is being processed; the entered dwell times are observed. With short dwell times, calculation of the hardware settings increases the dwell time for the initial processing cycle; the entered value is only observed from the second processing cycle onwards. In this case, a message indicates that there is a deviation between the current and set dwell times. After the first cycle, you do not need to perform additional calculations. The current dwell times do not deviate from the set dwell times.

### Blanking

The instrument applies *blanking*, which temporarily turns off the RF signal when the frequency or level changes, until the signal has settled to a stable state.

If you disable this blanking, the signal is not turned off during transition, but a temporary loss of power still occurs while the instrument adjusts the hardware. The power level immediately increases and can exceed the set level value before the hardware controls take effect. However, the time until the signal is stable and automatically level controlled is shorter than the time of the blanking interval.

Temporary blanking applies to all operating modes.

### Learn List Mode Data list processing mode

Before signal generation starts, the instrument reads the values of the data list in sequence and determines the corresponding hardware settings for each value pair. Along with the current RF state and the modulation settings, the function stores the list data in the temporary memory.

Once the entire table is processed, the R&S SMW200A starts signal generation by replaying the stored values from the list. Thus, it achieves fast switching of the RF signal with high accuracy.

This mode provides optimized switching times, and is particularly useful if dwell times of less than 2 ms are required.

However, consider that R&S SMW200A generates the signal from the saved data, thus reflecting the state of the instrument at the time of recording. Modifications of settings during list processing are ignored. If you turn off the instrument, the list file remains saved on the internal memory, but not the learned data in the temporary memory.

Consider also, that processing learned list mode data is not available when options R&S SMW-B711/-B721 are installed. In this configuration, the R&S SMW200A automatically switches to "[Live list processing mode](#)" on page 525.



#### When to use the "Learn List Mode Data" function

The instrument performs the learning process in the following situations:

- RF state is on (prerequisite)
- You deliberately activate this function, provided a list is loaded and RF is on.
- You switch list mode on in "Learned" run mode and no data is available in the memory
- You change the list data file

Perform the list mode learning in the following situations:

- Always when:
  - You change any value in the list.
  - Any hardware setting changes.  
Especially if you have fluctuating environmental conditions, the hardware settings need to be adjusted.
- We recommend that you learn the list before activating the list mode, even if the list has been learned previously.

#### Live list processing mode

The R&S SMW200A generates the signal directly from the value pairs in the database, and adjusts the hardware settings accordingly. The current instrument state and thus any change during the signal generation directly affects the RF signal. The temporary memory is not used.

You can conveniently modify parameters like modulation settings during run-time. Learning list mode data is not required. Impacts like temperature drift are also considered immediately.

This mode is optimized for **maximum signal quality**, and is useful if dwell times higher than 2 ms are sufficient.

### 8.10.5 Sweep mode settings

This section lists the settings of **all** available sweep modes.

Access:

1. Select "RF" > "Sweep / List" > "RF Frequency Sweep"
2. Select "RF" > "Sweep / List" > "RF Level Sweep"
3. Select "RF" > "Sweep / List" > "LF Frequency Sweep"

The sweep modes use the similar parameters to be configured. Thus, the description comprises the settings of all sweep dialogs. If parameters relate to only particular modes, they are pointed out.

The remote commands required to define these settings are described in:

- [Section 14.19.7, "SOURce:FREQuency subsystem"](#), on page 1197
- [Section 14.19.18, "SOURce:POWEr subsystem"](#), on page 1264
- [Section 14.19.21, "SOURce:SWEep subsystem"](#), on page 1287
- [Section 14.19.12, "SOURce:LFOutput subsystem"](#), on page 1227

Settings:

- [General sweep settings](#).....526
- [Frequency range settings](#).....530
- [Level range settings](#).....532

### 8.10.5.1 General sweep settings

Access:

- ▶ Select, for example, "RF" > "Sweep / List" > "RF Frequency Sweep".

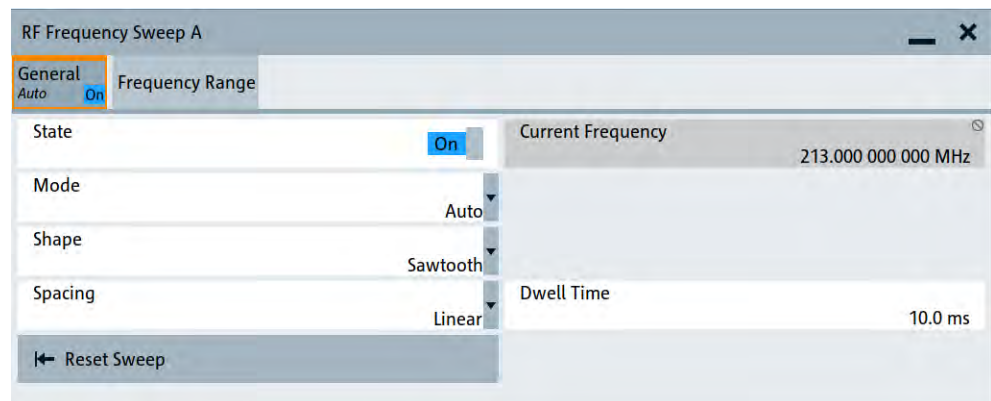

Settings:

- [State \(RF frequency sweep\)](#)..... 527
- [State \(RF level sweep\)](#).....527
- [State \(LF frequency sweep\)](#)..... 527
- [Current Frequency](#)..... 527
- [Current Level](#).....527
- [Mode](#)..... 528

Retrace.....	528
Shape.....	528
Spacing.....	529
Dwell Time.....	529
Trigger Slope.....	529
Execute Single Sweep.....	530
Show Connector.....	530
Reset Sweep.....	530

### State (RF frequency sweep)

Activates RF frequency sweep signal generation.

**Note:** Active RF frequency, RF level or RF combined sweep modes deactivate the LF sweep or List mode and vice versa.

Remote command:

[ :SOURce<hw> ] :FREQuency:MODE on page 1201

### State (RF level sweep)

Activates RF level sweep signal generation.

**Note:** Active RF frequency, RF level or RF combined sweep modes deactivate the LF sweep or List mode and vice versa.

Remote command:

[ :SOURce<hw> ] :POWer:MODE on page 1272

### State (LF frequency sweep)

Status of the LF frequency sweep signal.

You find this parameter in two dialogs:

- "LF Frequency Sweep" turns on/off the signal generation.  
See [Sweep mode settings](#) for access.
- "Analog Modulation Sources" displays the current state (read-only). If it is turned on, this dialog provides the varying sweep frequency, see [Current Frequency](#).

**Note:** Active RF frequency, RF level or RF combined sweep modes deactivate the LF sweep or List mode and vice versa.

Remote command:

[ :SOURce<hw> ] :LFOutput:FREQuency:MODE on page 1231

### Current Frequency

Displays the current frequency sweep value for all sweep [Modes](#), except of [Mode > Step](#). In this mode, you can enter the next frequency setting manually.

Remote command:

[ :SOURce<hw> ] :FREQuency:MANual on page 1203

[ :SOURce<hw> ] :LFOutput:FREQuency:MANual on page 1231

### Current Level

Displays the current level sweep value for all sweep [Modes](#), except of [Mode > Step](#). In this mode, you can enter the next level setting manually.

Remote command:

[ :SOURce<hw> ] :POWer:MANual on page 1272

**Mode**

Selects the sweep mode.

See [Section 8.10.1, "Signal generation and triggering in the sweep and list modes"](#), on page 511.

"Auto" Generates a continuously repeating sweep signal directly after activating the sweep mode.  
The sweep steps are performed automatically, controlled by the dwell time.

"Single / Extern Single" Generates a single sweep cycle after a trigger event.  
The sweep steps within the cycle are performed automatically, controlled by the dwell time. If one cycle is completed, the instrument waits for the next trigger event.

"Step / Extern Step" Generates the sweep signal step-by-step, manually triggered.

"Extern Start/Stop" Generates a continuously repeating sweep signal that is started, stopped, and restarted by subsequent external trigger events.  
The sweep steps are performed automatically, controlled by the dwell time.

Remote command:

RF frequency sweep:

[\[:SOURce<hw>\]:SWEep\[:FREQuency\]:MODE](#) on page 1292  
[:TRIGger<hw>:FSweep:SOURce](#) on page 1337

RF level sweep:

[\[:SOURce<hw>\]:SWEep:POWer:MODE](#) on page 1290  
[:TRIGger<hw>:PSweep:SOURce](#) on page 1337

LF frequency sweep:

[\[:SOURce<hw>\]:LFOutput:SWEep\[:FREQuency\]:MODE](#) on page 1237  
[:TRIGger<hw>:LFFSweep:SOURce](#) on page 1337

**Retrace**

For "Shape = Sawtooth" and "Mode = Single/External Single", enables changing the signal to the start value while it is waiting for the next trigger event. It returns to the start level or start frequency until the next trigger is applied.

See ["The Retrace function"](#) on page 518.

Remote command:

RF frequency sweep:

[\[:SOURce<hw>\]:SWEep\[:FREQuency\]:RETRace](#) on page 1294

RF level sweep:

[\[:SOURce<hw>\]:SWEep:POWer:RETRace](#) on page 1294

LF frequency sweep:

[\[:SOURce<hw>\]:LFOutput:SWEep\[:FREQuency\]:RETRace](#) on page 1238

**Shape**

Selects the waveform shape of the sweep signal.

See also [Section 8.10.2.2, "Sweep signal shapes"](#), on page 521.



## Varying the RF signal in list or sweep mode

- "Sawtooth" The sweep runs from start to stop frequency. The subsequent sweep starts at the start value, i.e. the shape of the sweep sequence resembles a sawtooth.
- "Triangle" The sweep runs from start to stop value and back, i.e. the shape of the sweep resembles a triangle. Each subsequent sweep starts at the start frequency.

Remote command:

RF frequency sweep:

[\[:SOURce<hw>\]:SWEep\[:FREQuency\]:SHAPE](#) on page 1293

RF level sweep:

[\[:SOURce<hw>\]:SWEep:POWer:SHAPE](#) on page 1293

LF frequency sweep:

[\[:SOURce<hw>\]:LFOutput:SWEep\[:FREQuency\]:SHAPE](#) on page 1239

### Spacing

In "RF and LF Frequency Sweep" mode, "Spacing" selects the mode for calculating the frequency interval, which increases or decreases the current frequency at each step.

To determine the step size, select the parameter [Step Linear/Step Logarithmic](#).

In "RF Combined Sweep" mode, the parameter indicates that the step intervals are linearly (straight proportional) distributed, i.e. the intervals have the same size. The frequency / level range and the [Dwell Time](#) time determine the calculated step size.

"Linear" Takes the frequency value entered as absolute value in Hz.

"Logarithmic" Takes the value entered as a logarithmic value, i.e. as a constant fraction of the current frequency in %.

Remote command:

RF frequency sweep:

[\[:SOURce<hw>\]:SWEep\[:FREQuency\]:SPACing](#) on page 1292

LF frequency sweep:

[\[:SOURce<hw>\]:LFOutput:SWEep\[:FREQuency\]:SPACing](#) on page 1239

### Dwell Time

Defines the duration of the individual sweep steps.

**Note:** In case of considerable overrun conditions, the R&S SMW200A turns off the sweep mode.

See also [Section 8.10.4, "Significant parameters and functions"](#), on page 523.

Remote command:

RF frequency sweep:

[\[:SOURce<hw>\]:SWEep\[:FREQuency\]:DWELl](#) on page 1291

RF level sweep:

[\[:SOURce<hw>\]:SWEep:POWer:DWELl](#) on page 1290

LF frequency sweep:

[\[:SOURce<hw>\]:LFOutput:SWEep\[:FREQuency\]:DWELl](#) on page 1237

### Trigger Slope

For "Mode = Extern Step/Single", selects the polarity of the active slope of an applied instrument trigger.

Trigger signal is expected at the INST TRIG x connector.

"Positive" The rising edge of the trigger signal triggers the instrument.

"Negative" The falling edge of the trigger signal triggers the instrument.

Remote command:

`[ :SOURce<hw> ] :INPut:TRIGger:SLOPe` on page 1209

### Execute Single Sweep

In "Mode = Single", starts a sweep manually.

Remote command:

RF frequency sweep:

`[ :SOURce<hw> ] :SWEep [ :FREQuency ] :EXECute` on page 1293

`:TRIGger<hw>:FSWep [ :IMMediate ]` on page 1338

RF level sweep:

`[ :SOURce<hw> ] :SWEep:POWer:EXECute` on page 1293

`:TRIGger<hw>:PSWep [ :IMMediate ]` on page 1339

LF frequency sweep:

`[ :SOURce<hw> ] :LFOutput:SWEep [ :FREQuency ] :EXECute` on page 1237

`:TRIGger<hw>:LFFSWep:IMMediate` on page 1338

General:

`:TRIGger<hw> [ :SWEep ] [ :IMMediate ]` on page 1339



### Show Connector

Accesses a dialog that displays the physical location of the selected connector on the front/rear panel of the instrument.

A blinking LED on the front/rear panel indicates the selected connector, too (see [Section 12.2.2.4, "Status indicators"](#), on page 746).

### Reset Sweep

Resets a sweep.

With the next trigger event, the sweep starts at the initial value.

Remote command:

`[ :SOURce<hw> ] :SWEep:RESet [ :ALL ]` on page 1295

## 8.10.5.2 Frequency range settings

Access:

1. Select for example "RF" > "Sweep / List" > "RF Frequency Sweep"
2. Select "Frequency Range".

RF Frequency Sweep A			
General	Frequency Range		
Auto	On		
Start Frequency	100.000 000 000 MHz	Stop Frequency	500.000 000 000 MHz
Center Frequency	300.000 000 000 MHz	Span	400.000 000 000 MHz
Spacing	Linear	Step Linear	1.000 000 000 MHz

**Settings:**

Start Frequency/Stop Frequency.....	531
Center Frequency.....	531
Span.....	531
Spacing.....	531
Step Linear/Step Logarithmic.....	532

**Start Frequency/Stop Frequency**

Defines the frequency sweep range by setting the start and end values.

See [Section 8.10.2.1, "Correlating parameters in sweep mode"](#), on page 519.

Remote command:

RF frequency sweep:

[ :SOURce<hw> ] :FREQuency:START on page 1205

[ :SOURce<hw> ] :FREQuency:STOP on page 1205

LF frequency sweep:

[ :SOURce<hw> ] :LFOutput:FREQuency:START on page 1232

[ :SOURce<hw> ] :LFOutput:FREQuency:STOP on page 1232

**Center Frequency**

In "RF Frequency Sweep" mode, sets the RF center frequency.

See [Section 8.10.2.1, "Correlating parameters in sweep mode"](#), on page 519.

Remote command:

[ :SOURce<hw> ] :FREQuency:CENTer on page 1204

**Span**

In "RF Frequency Sweep" mode, sets the span of the frequency sweep range.

See [Section 8.10.2.1, "Correlating parameters in sweep mode"](#), on page 519.

Remote command:

[ :SOURce<hw> ] :FREQuency:SPAN on page 1205

**Spacing**

In "RF and LF Frequency Sweep" mode, "Spacing" selects the mode for calculating the frequency interval, which increases or decreases the current frequency at each step.

To determine the step size, select the parameter [Step Linear/Step Logarithmic](#).

In "RF Combined Sweep" mode, the parameter indicates that the step intervals are linearly (straight proportional) distributed, i.e. the intervals have the same size. The frequency / level range and the [Dwell Time](#) time determine the calculated step size.

"Linear" Takes the frequency value entered as absolute value in Hz.

"Logarithmic" Takes the value entered as a logarithmic value, i.e. as a constant fraction of the current frequency in %.

Remote command:

RF frequency sweep:

[\[:SOURCE<hw>\]:SWEep\[:FREQuency\]:SPACing](#) on page 1292

LF frequency sweep:

[\[:SOURCE<hw>\]:LFOutput:SWEep\[:FREQuency\]:SPACing](#) on page 1239

### Step Linear/Step Logarithmic

In "RF/LF Frequency Sweep" mode, sets the step width for the individual frequency sweep steps. The value is added at each sweep step to the current frequency.

Depending on the current [Spacing](#), you can enter either an absolute or logarithmic step width.

See [Section 8.10.2.1, "Correlating parameters in sweep mode"](#), on page 519.

"Step Linear" The step width is a constant value in Hz.

"Step Logarithmic"

The step width is determined logarithmically in %, i.e. as a constant fraction of the current frequency.

Remote command:

[\[:SOURCE<hw>\]:SWEep\[:FREQuency\]:STEP\[:LINear\]](#)  
on page 1294

[\[:SOURCE<hw>\]:SWEep\[:FREQuency\]:STEP:LOGarithmic](#)  
on page 1294

[\[:SOURCE<hw>\]:LFOutput:SWEep\[:FREQuency\]:STEP\[:LINear\]](#) on page 1239

[\[:SOURCE<hw>\]:LFOutput:SWEep\[:FREQuency\]:STEP:LOGarithmic](#) on page 1239

### 8.10.5.3 Level range settings

Access:

1. Select "RF" > "Sweep / List" > "RF Level Sweep"
2. Select "Level Range".

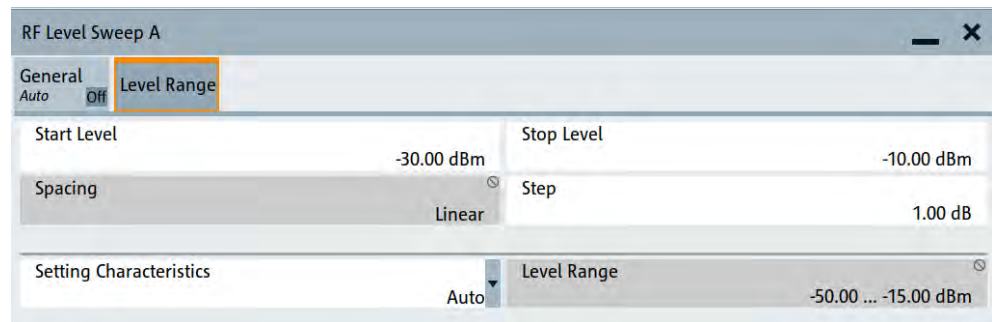
**Settings:**

<a href="#">Start Level / Stop Level</a> .....	533
<a href="#">Spacing</a> .....	533
<a href="#">Step</a> .....	533
<a href="#">Setting Characteristics</a> .....	533
<a href="#">Level Range</a> .....	535

**Start Level / Stop Level**

Defines the RF level sweep range by setting the start and end values.

See [Section 8.10.2.1, "Correlating parameters in sweep mode"](#), on page 519.

Remote command:

RF level sweep:

[\[:SOURce<hw>\]:POWer:START](#) on page 1274

[\[:SOURce<hw>\]:POWer:STOP](#) on page 1274

**Spacing**

Indicates that the instrument distributes the level steps linearly (straight proportional), i.e. the level steps have the same size.

To determine the step size, use the parameter [Step](#).

Remote command:

n.a.

**Step**

Sets the step width for the RF level sweep in dB.

The "RF level sweep" mode increases or decreases the level value linearly by the set value.

Remote command:

[\[:SOURce<hw>\]:SWEep:POWer:STEP\[:LOGarithmic\]](#) on page 1291

**Setting Characteristics**

Selects additional quality characteristics to optimize the behavior of the RF signal level for the specific application.

"Auto"	<p>Sets the RF output level automatically according to the selected mode.</p> <p>In this mode, the instrument provides the highest dynamic range and fastest setting times.</p> <p>The RF signal is shortly blanked when the step attenuator is switching.</p> <p>For more information, refer to the specifications document.</p>
"Uninterrupted"	<p>Suppresses blanking at level transitions. Frequency transitions can lead to an RF level blanking due to hardware-specific switching points.</p> <p>This mode reduces the dynamic range of the instrument. The step attenuator is fixed.</p> <p><b>Note:</b> Do not enable both the I/Q optimization mode "High Quality" and the RF signal level optimization mode "Uninterrupted" or "Strictly Monotone". The high-quality I/Q optimization mode leads to an RF signal interruption which blocks the RF signal level optimization.</p>
"Strictly Monotone"	<p>Executes signal level changes monotonically increasing or decreasing.</p> <p>The setting makes sure that increasing the level value exclusively results in an increased output level, and vice versa.</p> <p>All electronic switches, which can affect the monotonicity are fixed.</p> <p>The operation mode is useful for applications using level searching algorithms which rely on a strictly monotonous behavior.</p>
"Constant-VSWR"	<p>Suppresses output impedance variations at the RF A/RF B output connector, due to changed level settings.</p>
"Continuous-Phase"	<p>Suppresses phase discontinuities.</p> <p>This mode reduces the dynamic range of the instrument and the step attenuator is fixed (equates to "Strictly Monotone").</p>
"Constant-Phase"	<p>This mode keeps the phase constant by coupling the digital attenuation directly to the level setting.</p> <p><b>Note:</b> The coupling is only active when the I/Q modulator is in operation.</p> <p>Pressing <a href="#">Readjust</a> adds the value of the digital attenuation to the level setting, and sets the <a href="#">Digital Attenuation = 0</a>. In total, the level value remains constant.</p>
"User"	<p>Selects this entry automatically when you change one of the following parameters from the default setting:</p> <ul style="list-style-type: none"> <li>• "Attenuator" &gt; <a href="#">Mode</a></li> <li>• "ALC" &gt; <a href="#">State</a>, <a href="#">Detector Sensitivity</a> or <a href="#">Driver Amplifier</a></li> </ul> <p><b>Note:</b> If you select another setting characteristic, the R&amp;S SMW200A presets the modified attenuator and ALC parameters.</p>

Remote command:

[ :SOURce<hw> ] :POWer:LBEHaviour on page 1271

### Level Range

Shows the interruption-free range of the level that you can use in the currently selected mode.

Remote command:

[ :SOURce<hw> ] :POWer:RANGe:LOWer? on page 1280

[ :SOURce<hw> ] :POWer:RANGe:UPPer? on page 1280

## 8.10.6 List mode settings

The "List Mode" dialog contains all the functions and settings for creating and handling lists with RF frequency/level pairs for generating the RF signal based on these values.

Access:

- ▶ Select "RF" > "Sweep / List" > "List mode".

The dialog contains parameters for configuring the list mode processing, entering list mode data and transferring data files from or to the instrument.

The remote commands required to define these settings are described in [Section 14.19.13, "SOURce:LIST subsystem"](#), on page 1240.

- [General settings](#)..... 535
- [List mode data settings](#)..... 538
- [Import/export settings](#)..... 540

### 8.10.6.1 General settings

Access:

- ▶ Select "RF" > "Sweep / List" > "List Mode" > "General".

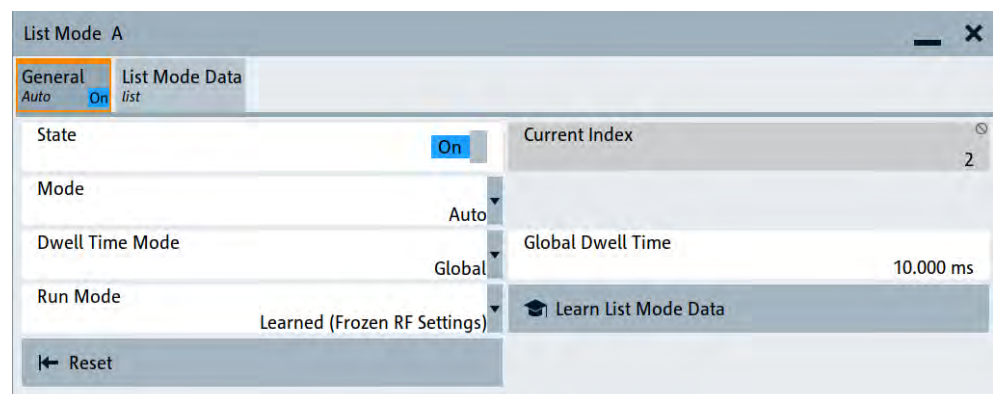

In the "General" tab, you can configure the trigger and dwell time modes for list processing and activate signal generation.

**Settings:**

State.....	536
Current Index.....	536
Mode.....	536
Dwell Time Mode.....	537
Global Dwell Time.....	537
Run Mode.....	537
Learn List Mode Data.....	538
Trigger Slope.....	538
Show Connector.....	538
Reset.....	538
Execute Single.....	538

**State**

Activates the list mode and processes the currently selected list.

**Note:** Active RF frequency, RF level or RF combined sweep modes deactivate the LF sweep or List mode and vice versa.

Remote command:

[ :SOURce<hw> ] :FREQuency:MODE on page 1201

**Current Index**

Sets the list index for list processing in "Step" mode. In the other modes, the index indicates the current step.

Remote command:

[ :SOURce<hw> ] :LIST:INDEX on page 1246

**Mode**

Selects the mode for list processing.

See [Section 8.10.1, "Signal generation and triggering in the sweep and list modes"](#), on page 511.

"Auto" Generates the signal by processing the frequency/level value pairs of the list from the beginning to the end.

The list steps are performed automatically, controlled by the dwell time. If you switch from any mode to "Auto", signal generation always starts at the top of the list.

"Single / Extern Single"

Generates the signal by processing the frequency/level value pairs of the list once from the beginning to the end after a trigger event.

The list steps are performed automatically, controlled by the dwell time. If one cycle is completed, the instrument waits for the next trigger event.

"Step / Extern Step"

Generates the signal by processing the frequency/level value pairs of the list step-by-step, manually triggered.



"Extern PDW Index" Option: R&S SMW-K503/-K504

Requires

- "I/Q Mod > I/Q Settings > I/Q Modulator" > "Internal baseband > Optimization Mode > Fast"
- "RF > RF Level > Automatic Level Control" > "State > Off (Table)".

Generates the signal by processing the frequency/level value pair triggered by the list index in the time control descriptor word (TCDW).

Remote command:

`[ :SOURce<hw> ] :LIST:TRIGger:SOURce` on page 1249

`[ :SOURce<hw> ] :LIST:MODE` on page 1247

### Dwell Time Mode

Selects either variable dwell times or a fixed dwell time to perform signal generation in list mode.

"Global" Uses the same dwell time for all lists steps, set with [Global Dwell Time](#).

"From List" Uses the dwell times from the list.  
You can define the dwell time for each frequency/level value pair individually, see [Section 8.10.7, "List data editor"](#), on page 542.

Remote command:

`[ :SOURce<hw> ] :LIST:DWELL:MODE` on page 1244

### Global Dwell Time

Sets the dwell time for [Dwell Time Mode](#) > "Global".

**Note:** In case of considerable overrun conditions, the R&S SMW200A turns off the list mode.

See also ["Dwell time"](#) on page 523.

Remote command:

`[ :SOURce<hw> ] :LIST:DWELL` on page 1244

### Run Mode

Selects whether the instrument generates the signal by processing the list directly, or by learning and replaying the data.

"Learned (Frozen RF Settings)"

Generates the signal with the previously learned and stored data from the temporary memory.

See ["Learn List Mode Data list processing mode"](#) on page 524.

"Live"

Generates the signal directly from the database.

The instrument reads the pairs of values from the list, calculates the hardware settings and generates the signal immediately.

See ["Live list processing mode"](#) on page 525.

Remote command:

`[ :SOURce<hw> ] :LIST:RMODE` on page 1247

**Learn List Mode Data**

Reads the settings from the list data table and calculates the associated hardware settings. The learned data is stored in the temporary memory.

See also "[When to use the "Learn List Mode Data" function](#)" on page 525.

Remote command:

`[ :SOURce<hw> ] :LIST:LEARn` on page 1247

**Trigger Slope**

For "Mode = Extern Step/Single", selects the polarity of the active slope of an applied instrument trigger.

Trigger signal is expected at the INST TRIG x connector.

"Positive"            The rising edge of the trigger signal triggers the instrument.

"Negative"           The falling edge of the trigger signal triggers the instrument.

Remote command:

`[ :SOURce<hw> ] :INPut:TRIGger:SLOPe` on page 1209

**Show Connector**

Accesses a dialog that displays the physical location of the selected connector on the front/rear panel of the instrument.

A blinking LED on the front/rear panel indicates the selected connector, too (see [Section 12.2.2.4, "Status indicators"](#), on page 746).

**Reset**

Resets the list to the starting point.

Remote command:

`[ :SOURce<hw> ] :LIST:RESet` on page 1251

**Execute Single**

Manually starts list processing in "Single" mode.

Remote command:

`[ :SOURce<hw> ] :LIST:TRIGger:EXECute` on page 1249

**8.10.6.2 List mode data settings**

Access:

1. Select "RF" > "Sweep / List" > "List mode".

## 2. Select "List Mode Data".

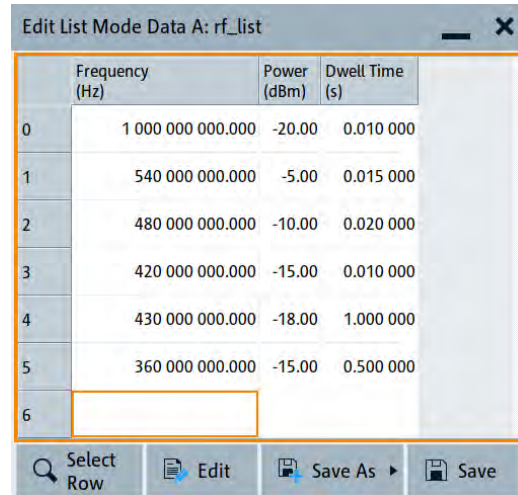

	Frequency (Hz)	Power (dBm)	Dwell Time (s)
0	1 000 000 000.000	-20.00	0.010 000
1	540 000 000.000	-5.00	0.015 000
2	480 000 000.000	-10.00	0.020 000
3	420 000 000.000	-15.00	0.010 000
4	430 000 000.000	-18.00	1.000 000
5	360 000 000.000	-15.00	0.500 000
6			

This dialog contains the parameters required for creating and editing lists, activating the learning function and selecting the list processing mode.

**Settings:**

List Mode Data.....	539
Edit List Mode Data.....	539
List Range from/to.....	539

**List Mode Data**

Accesses the standard "Select List" dialog for selecting, creating and editing a list file. The currently loaded file is indicated.

You can create data lists with the internal editor or import externally created files, see "[Creating and handling lists](#)" on page 522.

Remote command:

- [ :SOURce<hw> ] :LIST:CATalog? on page 1250
- [ :SOURce<hw> ] :LIST:SElect on page 1252
- [ :SOURce<hw> ] :LIST:DElete on page 1250
- [ :SOURce<hw> ] :LIST:DElete:ALL on page 1251

**Edit List Mode Data**

Opens the build-in table editor to define a new list data table or edit an existing one.

See also: [Section 8.10.7, "List data editor"](#), on page 542.

You find this function also in standard file select dialog, accessed via [List Mode Data](#).

**List Range from/to**

Defines an index range in the current list by setting the start and stop index.

The instrument generates the signal with the values of the selected index range and ignores all other list entries.

Remote command:

[ :SOURce<hw> ] :LIST:INDEX:START on page 1246

[ :SOURce<hw> ] :LIST:INDEX:STOP on page 1246

### 8.10.6.3 Import/export settings

Access:

1. Select "RF" > "Sweep / List" > "List Mode".
2. Select "List Mode Data" > "Im-/Export".

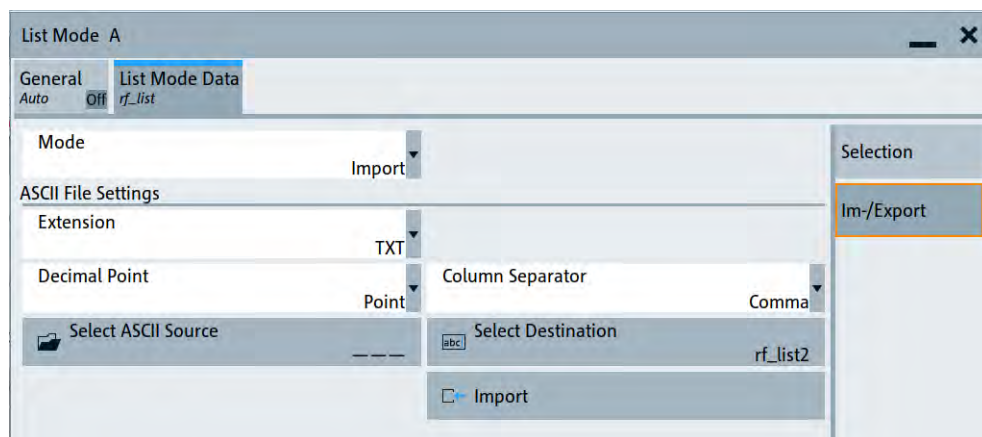

The "Im-/Export" dialog provides the parameters for importing or exporting files with user data in standard ASCII \*.txt or \*.csv file format.

The table separators and the decimal floating point numbers are customizable.



Since you need to determine the same parameters for all standard ASCII file formats, the settings of these dialogs are similar to the settings of user correction, for example.

Therefore, [Section 8.12.3.4, "Import/export list files"](#), on page 598 describes the settings in general.

#### Settings:

<a href="#">Mode</a> .....	540
<a href="#">ASCII File Settings</a> .....	541
<a href="#">Select (ASCII) Source/Select (ASCII) Destination</a> .....	541
<a href="#">Select Source/Select ASCII Destination</a> .....	541
<a href="#">Import / Export</a> .....	541

#### Mode

Selects import or export of a data list file. The provided parameters vary according to the selected mode.

Remote command:

[ :SOURce<hw> ] :LIST:DEXChange:MODE on page 1254

[ :SOURce<hw> ] :CORRection:DEXChange:MODE on page 1192

**ASCII File Settings**

Defines the format and the separators of the associated data file.

"Extension"	Selects *.csv or *.txt format.
"Decimal Point"	Sets "Point" (dot) or "Comma" as the decimal separator used in the ASCII data with floating-point numerals.
"Column Separator"	Sets the separator between the columns in an ASCII table. Available are: "Tab", "Semicolon", "Comma" or "Space".

Remote command:

[\[:SOURCE<hw>\]:LIST:DEXChange:AFIle:EXTension](#) on page 1252  
[\[:SOURCE<hw>\]:LIST:DEXChange:AFIle:SEParator:DECimal](#) on page 1253  
[\[:SOURCE<hw>\]:LIST:DEXChange:AFIle:SEParator:COLumn](#) on page 1253  
[\[:SOURCE<hw>\]:CORRection:DEXChange:AFIle:EXTension](#) on page 1191  
[\[:SOURCE<hw>\]:CORRection:DEXChange:AFIle:SEParator:DECimal](#)  
 on page 1192  
[\[:SOURCE<hw>\]:CORRection:DEXChange:AFIle:SEParator:COLumn](#)  
 on page 1192

**Select (ASCII) Source/Select (ASCII) Destination**

In "Mode > Import", access the file select dialog that provides standard file handling functions.

Where:

- "Select ASCII Source": defines the file to be loaded (imported)
- "Select ASCII Destination": selects the filename under that the loaded file is saved

Remote command:

[\[:SOURCE<hw>\]:LIST:DEXChange:AFIle:CATalog?](#) on page 1252  
[\[:SOURCE<hw>\]:LIST:DEXChange:AFIle:SElect](#) on page 1253  
[\[:SOURCE<hw>\]:CORRection:DEXChange:AFIle:CATalog?](#) on page 1191  
[\[:SOURCE<hw>\]:CORRection:DEXChange:AFIle:SElect](#) on page 1191

**Select Source/Select ASCII Destination**

In "Mode > Export", access the file select dialog that provides standard file handling functions.

Where:

- "Select Source": selects the file to be exported
- "Select ASCII Destination": defines the filename and the file path for the exported file

Remote command:

[\[:SOURCE<hw>\]:LIST:DEXChange:SElect](#) on page 1254  
[\[:SOURCE<hw>\]:CORRection:DEXChange:SElect](#) on page 1193

**Import / Export**

Imports or exports the selected data list file, depending on the current mode.

Remote command:

[\[:SOURCE<hw>\]:LIST:DEXChange:EXECute](#) on page 1253  
[\[:SOURCE<hw>\]:CORRection:DEXChange:EXECute](#) on page 1192

### 8.10.7 List data editor

The "List Mode" dialog provides a build-in list editor for defining the corresponding frequency and level value pairs. Prerequisite to define list mode data is that you have selected a file.

Access:

- ▶ "RF" > "Sweep / List" > "List Mode" > "List Mode Data" > "Edit List Mode Data"

The editor for list mode provides a table with RF frequency and power values, a column for defining variable dwell times, and standard navigation functions.

	Frequency (Hz)	Power (dBm)	Dwell Time (s)
0	1 000 000 000.000	-20.00	0.010 000
1	540 000 000.000	-5.00	0.015 000
2	480 000 000.000	-10.00	0.020 000
3	420 000 000.000	-15.00	0.010 000
4	430 000 000.000	-18.00	1.000 000
5	360 000 000.000	-15.00	0.500 000
6			

The remote commands required to define the list mode data are described in [Section 14.19.13, "SOURCE:LIST subsystem"](#), on page 1240.



All columns in a row must contain values. Cells with missing values are therefore filled automatically, using the value of the previous row.

Once you enter a value, the editor automatically adds preset values in the other columns. This functionality protects against data loss, otherwise incomplete rows are lost when saving. You can simply override these values.

If you use **global dwell time in list mode**, consider also that the instrument uses the value set with [Global Dwell Time](#) for all list steps and not the values from the list.

Since the table and navigation functions can be assumed to be known, the following description contains a brief overview.

#### Settings:

Frequency (Hz).....	543
Power (dBm).....	543
Dwell Time (s).....	543
Data handling keys.....	543
L Select Row.....	543

L Edit.....	543
L Save As/Save.....	543
Fill.....	543

**Frequency (Hz)**

Sets the frequency values for list mode operation.

Remote command:

[ :SOURce<hw> ] :LIST:FREQuency on page 1245

**Power (dBm)**

Sets the level value for the selected frequency in list mode.

Remote command:

[ :SOURce<hw> ] :LIST:POWer on page 1248

**Dwell Time (s)**

Sets the dwell time values for the frequency power value pairs in list mode operation.

Remote command:

[ :SOURce<hw> ] :LIST:DWELL:LIST on page 1245

**Data handling keys**

Standard functions for file and data handling.

**Select Row ← Data handling keys**

Selects a row for editing.

**Edit ← Data handling keys**

Enables you to insert, or delete a row or ranges within the table, and provides access to a dialog for automatic filling, see "Fill..." on page 543.

**Save As/Save ← Data handling keys**

Saves the table in a file with user-defined name and predefined file extension. To save a copy or create a file, use the "Save as" function.

**Fill...**

Provides parameters for filling a table automatically with user-defined values.

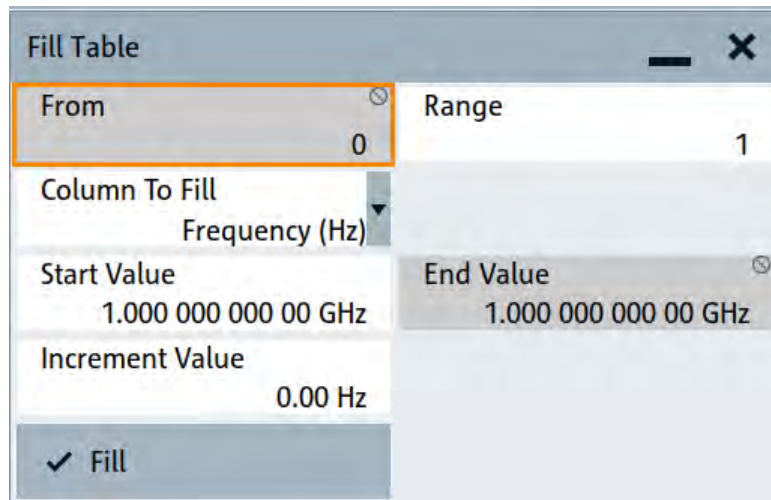

To fill the table, select "Fill".

**Note:** Once you enter a value or fill a column, the editor automatically adds preset values in the other columns. This functionality protects against data loss, otherwise incomplete rows will be lost when saving. You can simply override these values.

"From / Range"

Defines the start line and number of lines to be filled.

"Column To Fill"

Selects, if the column is filled up with frequencies in Hz, levels in dBm or dwell times in s.

"Start Value / End Value"

Sets the start value for frequency, level or dwell time. The end value is read only and depends on the increment value and the range.

"Increment Value"

Determines the step size.

"Fill"

Fills the column specified in "Column To fill".

### 8.10.8 How to generate a signal in list or sweep mode

This section shows you how to configure a varying RF output signal for both, the list and sweep modes.

#### To configure the frequency sweep signal

1. In the status bar, enter "Freq = 6 GHz" and "Lev = -25 dBm".
2. Select "RF" > "Sweep / List" > "RF Frequency Sweep"
3. Select "Mode > Auto".
4. Select "Spacing > Linear".
5. Set "Dwell Time > 15.0 ms".



6. In the "Frequency Range" tab, set "Start Freq > 200 MHz" and "Stop Freq > 600 MHz".  
(Alternatively you can set "Center Freq > 400 MHz" and "Span > 400 MHz".)
7. Set the step width "Step Lin > 10 MHz" and "Dwell Time > 10.0 ms".
8. In the "Advanced" tab, trigger the sweep "Auto".
9. In the "General" tab, select "State > On".

#### **Example: Fast changing frequency and level settings in list mode**

The following example shows you how to generate an amplitude modulated RF signal based on list mode data.

#### **General workflow**

Since any change of the hardware settings or list entries can affect the RF signal characteristics directly, we recommend that you proceed as follows:

1. Configure the modulation settings.  
Activate the RF signal.
2. Wait until the hardware settings have settled.
3. Create a list file.
4. Configure the list mode.
5. Execute "Learn List Mode Data" if necessary.
6. Activate list mode.

#### **To configure amplitude modulation and switch RF on**

1. Press [PRESET] to start from an initial state.
2. Select "RF" > "Analog Modulation" > "Amplitude Modulation > On".
3. Select "RF > On" to activate RF signal generation.

#### **To create list mode data**

1. Select "RF" > "Sweep / List" > "List Mode".
2. In the "List Mode Data" tab, select "List Mode Data > New"
3. Enter the filename `ListMode_Test` for the data list and confirm with "Ok".  
The instrument creates a file and stores it in the `/var/user/` directory.
4. Select "Edit List Mode Data".
5. Enter the first values "Frequency > 2", "Power > 0" and "Dwell > 2".
6. Enter further frequency, power and dwell time values in the same way.
7. Select "Save" and close the dialog.

**To configure the list mode and start signal generation**

1. In the "General" tab, select "List Mode > Auto".
2. Select "Dwell Time Mode > From List".
3. Select "List Mode Data > Learn List Mode Data".
4. Switch state to "On".
5. Select "Run Mode > Learned (Frozen RF Settings)".
6. Select "General > State > On".

The instrument continuously generates an amplitude-modulated RF signal whose frequency and level values change according to the dwell times, as defined in the list.

With active list mode, the generator displays no frequency and level values in the status bar, but you can check the following parameters.

- In the list mode dialog, the current index indicates the steps of the signal generation.
- In remote control mode, you can query:
  - The current state with `[ :SOURce<hw> ] :LIST:RUNning?`
  - Current parameters with the commands `FREQ?`, `POW?` and `LIST:DWEL?`.

## 8.11 Analog modulations

Analog modulation is a method used to transmit information of an LF (Low Frequency) signal in accordance with a second signal, typically one of a higher frequency. This is done by varying one or more properties of a high frequency waveform, called the modulation or carrier signal, with the modulating signal that contains the information to be transmitted.

The three key parameters of the modulation signal are the:

- Amplitude
- Phase
- Frequency

These parameters are modified in accordance with the low frequency signal to obtain the modulated RF signal.

The R&S SMW200A supports AM (Amplitude Modulation), FM (Frequency Modulation),  $\Phi$ M (Phase Modulation (PhiM)), and also PULM (Pulse Modulation).

It generates LF modulation signals as sine, triangle, trapezoidal or square (pulse) waveform, that can be output for use in a downstream instrument. You can also create various interference signals such as white noise with selectable bandwidth and level distribution.

A monitor function allows you to synchronize the LF output signal with the amplitude, frequency or phase modulation signal.

The instrument provides the following internal **modulation signal sources**:

- An LF generator
- A multifunction generator and a noise generator
- A high performance pulse generator

The R&S SMW200A generates both the carrier (LF) and RF frequencies, provides sine or square waves, waveforms with rising and falling edges (triangle, sawtooth and trapezoid), and various noise signals, such as a white noise with selectable bandwidth and level distribution.

To configure and perform a modulation, you need to select the LF modulation signal source, configure the LF signal, and determine the settings of the modulation.

See the following sections for detailed information:

- [Modulation signals](#) describes the characteristics of the available modulation signal sources, and provides access to the [RF connectors settings](#).
- [Modulation signal waveforms](#) shows the waveform shapes and their respective parameters graphically.
- [Modulation settings](#) contains the settings for the AM, FM, PhiM and Pulse modulation.
- [Output settings](#) enables you to select the signal for output, and to specify the amplitude and an offset.



### Interactions and characteristics

- Some modulations exclude each other and cannot be performed simultaneously.
- For instruments equipped with R&S SMW-B2031/-B2044(N), amplitude modulation, frequency modulation and phase modulation are only possible in RF path A. When activating frequency or phase modulation in RF path A, the R&S SMW200A turns off signal generation in RF path B.
- For pulse modulated signals, you can select between fast or smoothed transitions, see "[Transition Type](#)" on page 558.  
This setting is available over the entire frequency range for all instruments with frequency options up to 6 GHz. For higher frequency options, the frequency range for the smoothed setting is limited.

For more information, refer to the specifications document.

- The settings of the modulation signal affect all analog modulations that use an internal modulation source.
- In sweep mode, LF frequency sweep is possible.
- You can feed an external LF signal in each of the two paths.
- An activated analog modulation automatically turns off:
  - I/Q modulation
  - Arbitrary waveform generation
  - Digital modulation
  - Digital standards

For more information, refer to the specifications document.

## 8.11.1 Required options

The equipment layout for generating the analog modulation signals includes per signal path:

- Option frequency (e.g. R&S SMW-B1003)
- Option baseband main module, one/two I/Q paths to RF (R&S SMW-B13/-B13T) or option wideband baseband main module two I/Q paths to RF (R&S SMW-B13XT)  
To perform for example I/Q modulation and an analog frequency or phase modulation in one path simultaneously, option R&S SMW-B13T/B13XT must be installed.
- Option pulse modulator (R&S SMW-K22)
- Option high performance pulse generator (R&S SMW-K23)
- Option multi-function generator (R&S SMW-K24)
- Option AM/FM/PhiM (R&S SMW-K720)
- *earlier RF hardware versions:*
  - Option FM/PhiM modulator (R&S SMW-B20) or
  - Option FM/PhiM modulator and low phase noise (R&S SMW-B22)

## 8.11.2 Modulation signals

The signal sources for the modulation signal are two internal generators, LF and Noise, and a pulse generator, but you can also use an externally supplied signal, see [External signal sources](#).

You can perform the AM, FM and PhiM with the signal of any of the provided sources. Even more, you can merge two modulation signals, for example, to generate a two-tone signal. Similarly, you can forward the used modulation signal to the output.

### 8.11.2.1 Internal signal sources

Fully equipped, the R&S SMW200A provides the following internal modulation sources:

- **LF Generator**  
Supplies sinusoidal and square waves in the frequency range 0.1 Hz to 1 MHz and selectable shapes.  
To obtain a triangle, trapezoid or square wave, a pulse signal, the R&S SMW200A converts the sinusoidal signal internally to the respective shape.
- **Multifunction generator**  
A further LF generator for use as a second modulation source. It features an extended frequency range of 0.1 Hz to 10 MHz and selectable signal shapes. Alternatively, you can use it to generate a noise modulation signal.
- **Noise generator**  
Supplies white noise with selectable bandwidth and level distribution.
- **High performance pulse generator**  
Allows you to generate either single or double pulse signals.

### 8.11.2.2 External signal sources

For the input of an external amplitude, frequency or phase modulation signal, you can assign the signal at the EXT connectors.

External pulse modulation signals are fed via the global connectors, assigned in the "Global Connector Settings" dialog, see [Section 12.2.5, "Global connectors settings"](#), on page 752.



The external modulation signal at the input must have a voltage of  $U_S = 1 \text{ V}$  ( $U_{\text{EFF}} = 0.707 \text{ V}$ , in case of sine signals) to achieve the displayed modulation depth and range. The input voltage should not exceed 1.1 V, otherwise modulation distortions might occur. With external pulse modulation, the switching point is max. 2.4 V and the voltage at the input should not exceed 5 V. The maximum modulation frequency is 10 MHz for frequency and phase modulation.

### 8.11.2.3 Assigning the LF signal to the output

The R&S SMW200A can also act as the source for modulations in downstream equipment. Regardless of the used signal source, which can be the internally generated or

an externally fed LF modulation signal, you can optionally select the signal for output. The LF signal is output at the LF OUT x connectors.



Note that the output of the internal LF signal and the analog I/Q signal use the same physical connectors (LF OUT x and I/Q out x), that means these signals cannot be output simultaneously. If both, the I/Q and the LF signal output are switched on, the I/Q signal is suppressed and the instrument provides the LF signal.

You can freely assign the LF signals from both paths (A or B) to the outputs. To perform the assignment, use the "LF Output" tab. It is available both in the "Modulation" dialog of path A and path B, but the functionality applies to both paths the same way. Therefore, the instrument adjusts your settings always in parallel. The "Overview" tab shows the current configuration graphically, and allows you to modify the assignments there directly. The assignment of the shown LF output is of course in both paths the same.

Since there are two LF output connectors, but the R&S SMW200A can process multiple LF signals simultaneously, there are some configurations that exclude each other.

See the following examples to the overview tab, the versatile options for configuring the modulation signals and the graphical representation of the signal flow.

#### **Example: Introduction to the "Overview" tab**

This example briefly explains the view and the elements of the "Overview" tab of the two paths (A and B). The tab shows the two common LF output signal connectors, which are the same in both paths, and the specific modulation settings of the respective path. Active signals are indicated by a blue output box.

The following modulations are configured:

- Path A (first image)  
Amplitude modulation that is performed with an internally generated trapezoid wave signal and a superposed external signal.
- Path B (second image)  
Amplitude modulation, performed with the sine signal of the LF Generator 2 and a superposed noise signal.  
Simultaneously, the instrument performs frequency modulation with an LF signal that is composed of a sine wave (LF Generator 1, path B) and an external signal.
- LF OUT x (the same in both images)  
The LF signal of the LF generator 1 in path A is routed to the first LF output, and the signal of second LF generator - to the second LF output.  
This assignment is not mandatory. It has been chosen randomly and can be changed arbitrarily.

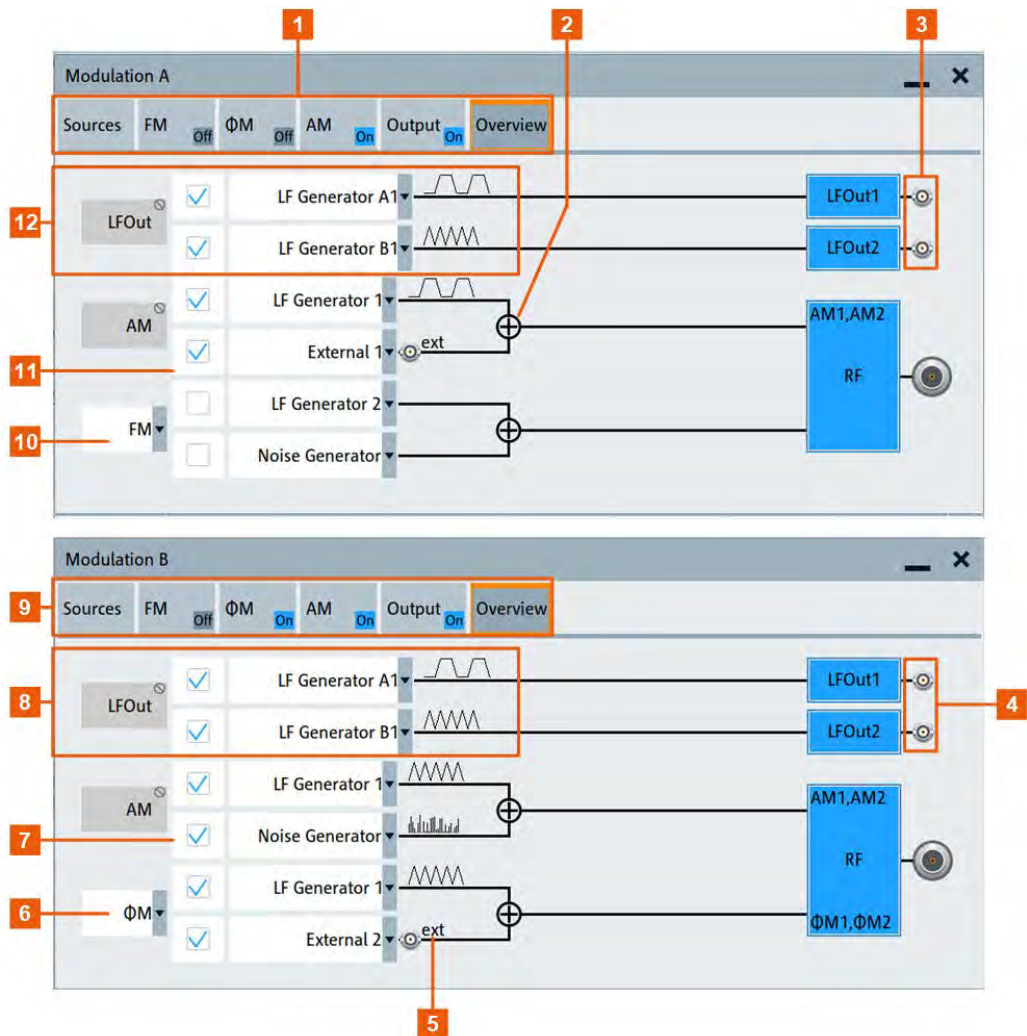

**Figure 8-17: Example: Elements in the analog modulations "Overview" tab**

- 1, 9 = Modulation dialogs of path A, and path B
- 2, 5 = external input connectors 1 and 2
- 3, 4 = LF output connectors 1 and 2
- 6, 10 = Selection between FM and  $\phi$ M
- 7, 11 = modulation signal sources used in path A, and path B
- 8, 12 = assigned modulation signals to the LF outputs 1 and 2

This tab reflects the signal sources of the analog modulations AM, FM and  $\phi$ M as in the corresponding settings dialogs. Therefore, you can also select the signal source as well as turn a modulation on or off in this tab. Corresponding to the activated modulation, the used signal sources are displayed. Furthermore, the overview also shows the signals that are routed to one of the LF output connectors.

#### **Example: Assigning a composite modulation signal to the LF output**

This example shows two different configurations for analog modulations in path A.

The following modulations are configured:

- Analog modulation (first image)  
Amplitude modulation performed with an internally generated trapezoid wave signal and a superposed external signal. This composite LF signal is assigned to the output LF OUT x 1.  
Simultaneously, the instrument performs phase modulation with an LF signal that is composed of an external signal and a sine wave, provided by the "LF Generator 2". This signal is used for the modulation and does not affect the LF output.
- Path B  
Phase modulation performed with two internally generated trapezoid wave signals that are combined and routed to the output LF OUT x 1.

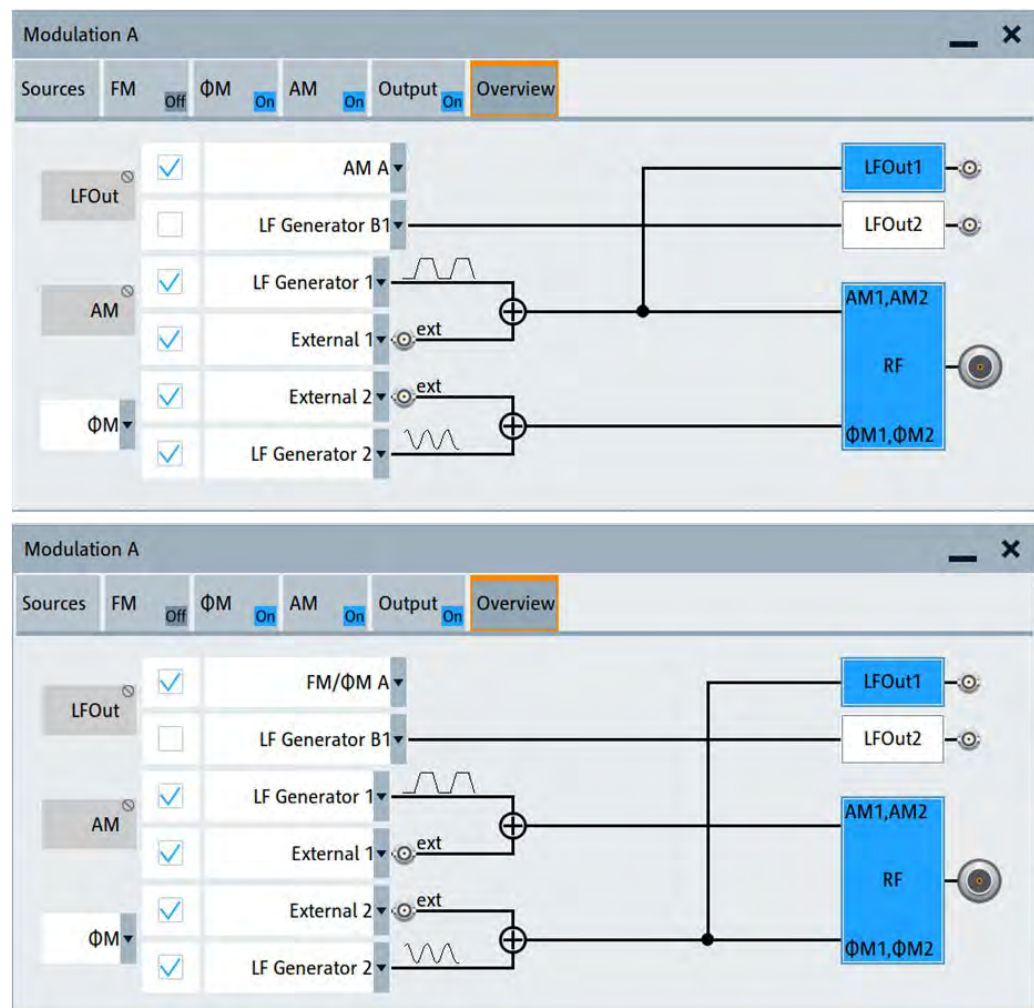

In the first image, both signals selected for the amplitude modulation in path A are combined. The instrument performs the amplitude modulation with this signal and also provides it at the LF output.

The second image shows the similar configuration set up for the phase modulation.



### Example: Assigning two independent composite modulation signals to the LF outputs

This example shows the following configuration:

- Path A  
Amplitude modulation performed with an internally generated square wave signal and a superposed external signal. This composite LF signal is also assigned to the output LF OUT x 2. Simultaneously, the instrument performs frequency modulation with an LF signal that is composed of the internally generated sine wave, superposed with noise. This signal is used for the modulation and does not affect the LF output.
- Path B  
Phase modulation performed with two internally generated trapezoid wave signals that are combined and routed to the output LF OUT x 1.

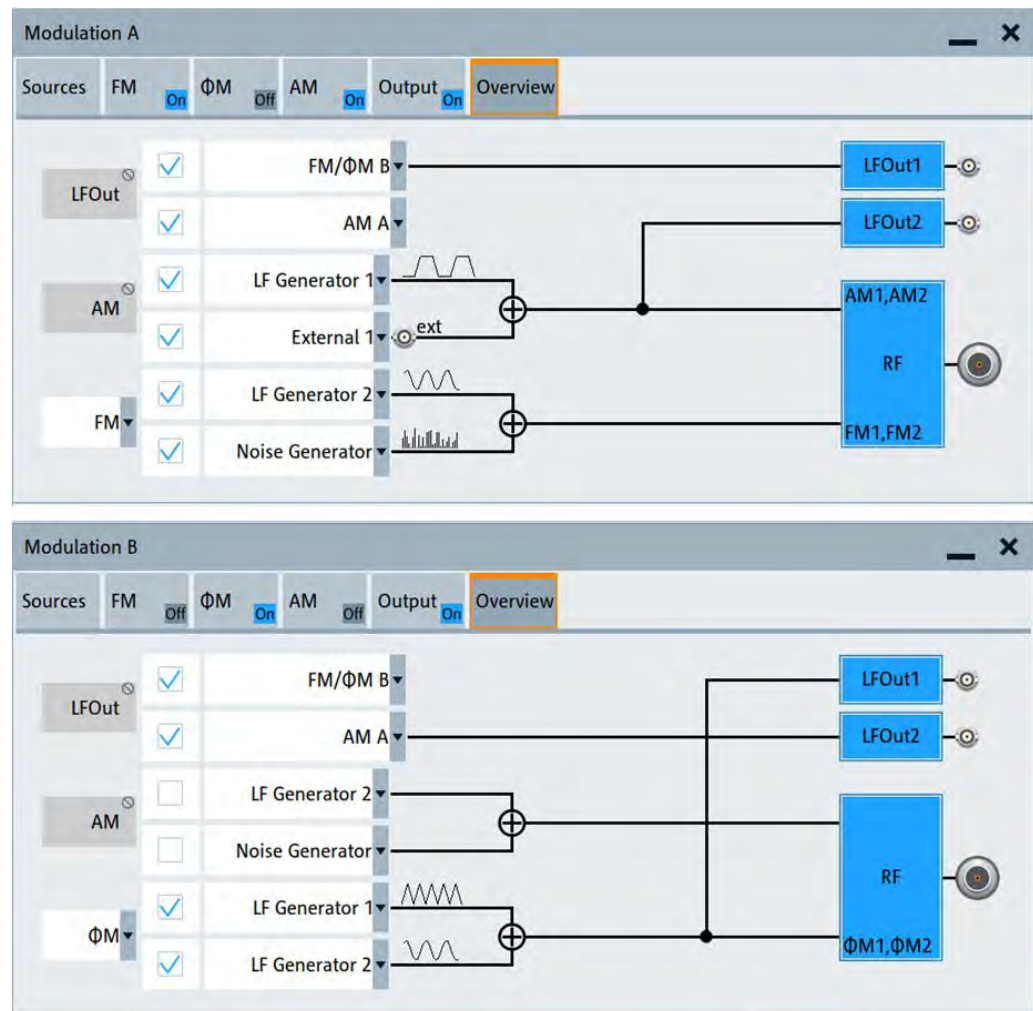

The two images illustrate how the same configuration is displayed in the "Overview" tabs of the two paths.

In the tab of path A (see the first image), you can see the settings of the modulations in path A. The signal coming from B is only displayed. Vice versa, the tab in the path B

(second image) shows the configuration of the modulations of this path, but also the signal coming from A.

#### 8.11.2.4 Modulation signal waveforms

The following graphs show the modulation signal waveforms of the R&S SMW200A.

##### LF Generator

The LF and multifunction generators support the following signal shapes:

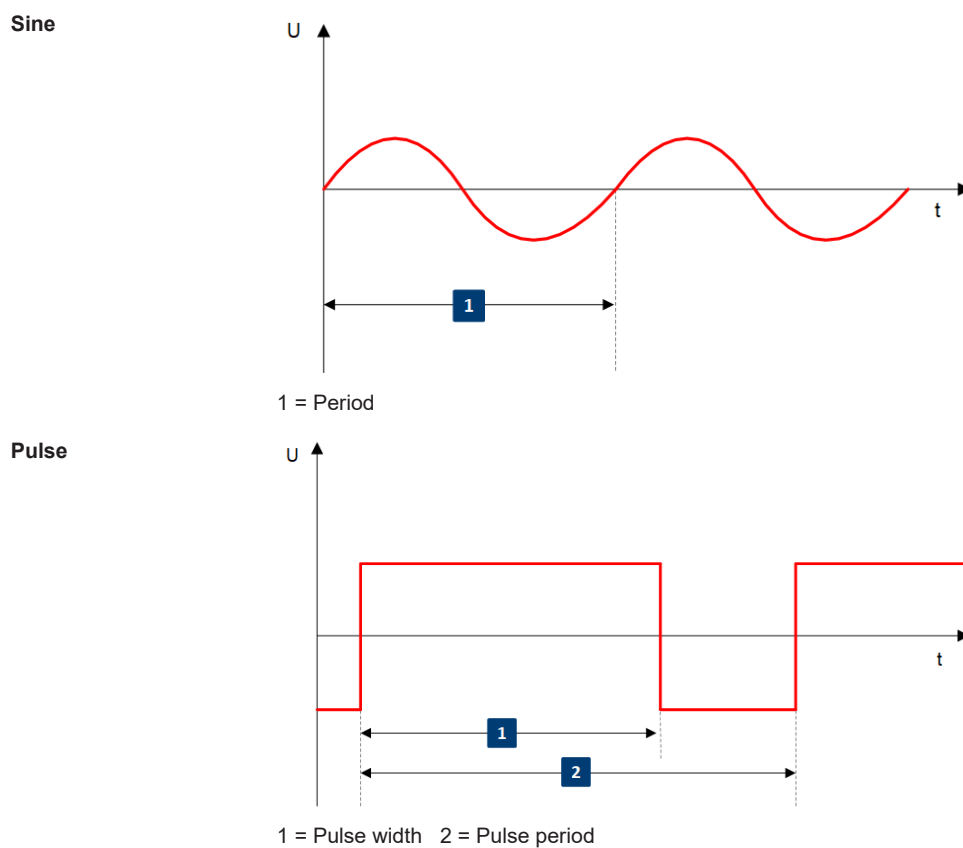

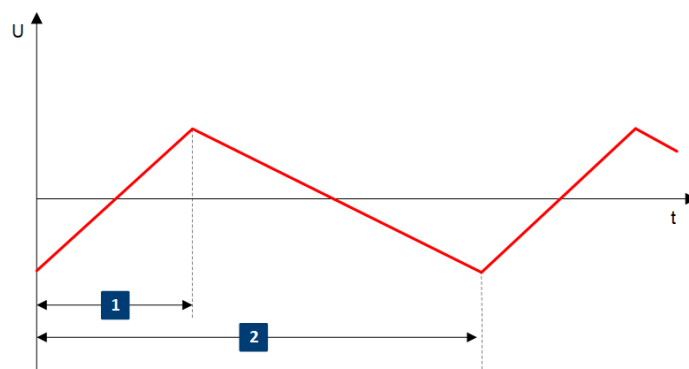
**Triangle**

1 = Triangle rise 2 = Triangle period

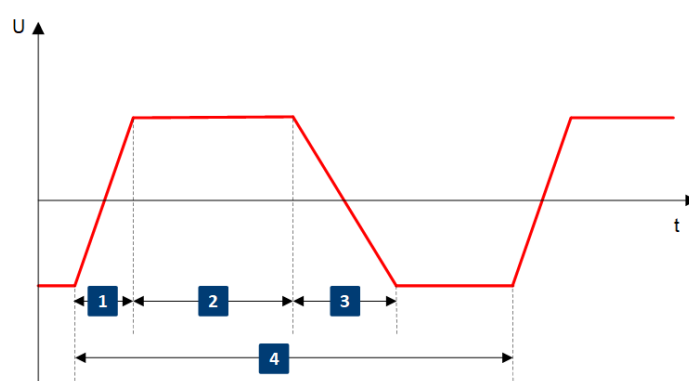
**Trapezoid**

1 = Trapezoid rise 2 = Trapezoid high

3 = Trapezoid fall 4 = Trapezoid period

To configure the associated parameters of a signal shape, see "[Shape](#)" on page 572.

**Pulse Generator**

The high performance pulse generator enables you to generate single or double pulse signals.

## Single

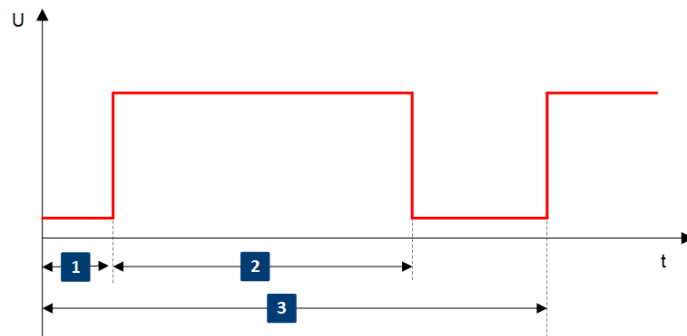

1 = Pulse delay 2 = Pulse width 2 = Pulse Period

## Double

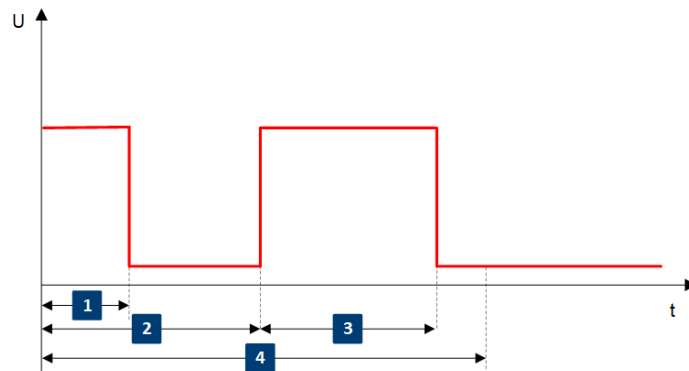

1 = Pulse width 2 = Double pulse delay  
3 = Double pulse width 4 = Pulse period

### 8.11.3 Activating analog modulations

1. Option: R&S SMW-B9  
Select "System Config" > "Fading/Baseband Config" > "Mode" = "Standard".
2. Option: R&S SMW-B10  
Use one of the following:
  - Select "RF" > "Amplitude Modulation/Frequency Modulation/Phase Modulation" > "State" > "ON".
  - Select "Mod Off" > "Modulation On" in the status bar.
  - Press the [MOD ON/OFF] key on the front panel.

#### [MOD ON/OFF]

Activate one or more analog modulations and press the [MOD ON/OFF] key to toggle the state of them all.

Pressing the key again restores the status that was active before the last switch-off.

Remote command:

`[ :SOURce<hw> ] :MODulation [ :ALL ] [ :STATe ]` on page 1036

## 8.11.4 Modulation settings

Access:

- ▶ Select "RF" > "Analog Modulation".

The "Modulation" dialog contains all functions and settings to configure the analog modulations, the LF signal sources for performing a modulation, and the LF signal output.

The remote commands required to define these settings are described in:

- [Section 14.19.4.2, "SOURCE:AM subsystem"](#), on page 1037
- [Section 14.19.4.3, "SOURCE:FM subsystem"](#), on page 1041
- [Section 14.19.4.4, "SOURCE:PM subsystem"](#), on page 1046
- [Section 14.19.4.5, "SOURCE:PULM subsystem"](#), on page 1051
- [Section 14.19.12, "SOURCE:LFOutput subsystem"](#), on page 1227

### 8.11.4.1 Pulse modulation settings

Access:

- ▶ Select "RF" > "Analog Modulation" > "Pulse Modulation".

**Table 8-8: Pulse Modulation**

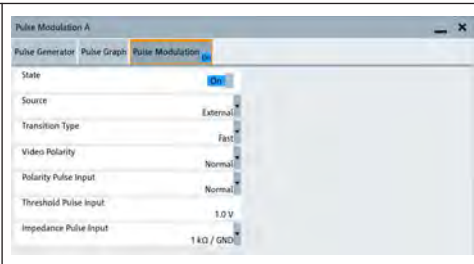
	
"Signal Source" > "Pulse Generator" (internal)	"Signal Source" > "External"

The "Pulse Modulation" dialog contains all parameters required to configure pulse modulation and pulse signal generation.

It also displays the pulse signal graphically.

The remote commands required to define these settings are described in [Section 14.19.4.5, "SOURCE:PULM subsystem"](#), on page 1051.

**Settings:**

<a href="#">State</a> .....	558
<a href="#">Source</a> .....	558
<a href="#">Transition Type</a> .....	558
<a href="#">Video Polarity</a> .....	558
<a href="#">Polarity Pulse Input</a> .....	559
<a href="#">Threshold USER4-6 Input/Threshold Pulse Input</a> .....	559
<a href="#">Impedance Pulse Input</a> .....	559

**State**

Option: R&S SMW-B9 - enabled in "System Config" > "Mode" = "Standard".

Option: R&S SMW-B10 - enabled in "System Config" > "Mode" = "Standard"/"Advanced".

Activates pulse modulation.

Remote command:

[\[:SOURce<hw>\]:PULM:STATe](#) on page 1054

**Source**

Selects between the internal "Pulse Generator" or an "External" pulse signal for the modulation.

"Pulse Generator"

Selects the internal generator.

See [Pulse generator settings](#).

"External"

Modulation source is fed to the input connector.

See [Section 8.11.2.2, "External signal sources"](#), on page 549.

Remote command:

[\[:SOURce<hw>\]:PULM:SOURce](#) on page 1055

**Transition Type**

Selects between "Fast" or "Smoothed" slew rate (slope).

"Fast"

Enables fast transitions with shortest rise and fall times.

"Smoothed"

Flattens the slew rate, resulting in longer rise / fall times. Use this mode if you are working with devices that are sensitive to steep slopes.

For more information, refer to the specifications document.

**Note:** The R&S SMW200A supports this functionality up to a certain frequency, depending on the installed frequency options, see also ["Interactions and characteristics"](#) on page 548.

For more information, refer to the specifications document.

For more information, refer to the specifications document.

Remote command:

[\[:SOURce<hw>\]:PULM:TTYPe](#) on page 1055

**Video Polarity**

Sets the polarity of the internally generated pulse video (modulating) signal, related to the RF (modulated) signal.

This signal synchronizes the pulse generator signal and the RF signal.

"Normal"

The video signal level follows the RF signal, that means it is high and low simultaneously with the RF signal.

"Inverse"

Inverts the polarity between the video and the RF signal, that means it is high, when RF is low, and vice versa.

Remote command:

[\[:SOURce<hw>\]:PULM:OUTPut:VIDeo:POLarity](#) on page 1055

**Polarity Pulse Input**

Sets the polarity of the active slope of a pulse input signal, that is the external pulse modulation signal.

Remote command:

`[ :SOURce<hw> ] :PULM:POLarity` on page 1056

**Threshold USER4-6 Input/Threshold Pulse Input**

Sets the high/low threshold in volts for the signal at the USER4-6 connectors.

The input signal is defined with the parameter [Signal](#). The same threshold applies for all 3 connectors and any input signal (e.g. external pulse modulation or trigger signal).

Remote command:

`[ :SOURce ] :INPut:USER:PULM:LEVel` on page 1014

**Impedance Pulse Input**

Selects the input impedance for an external pulse modulation signal.

Remote command:

`[ :SOURce<hw> ] :PULM:IMPedance` on page 1056

**8.11.4.2 AM, FM and PhiM modulation settings**

Access:

- ▶ Select "RF" > "Amplitude Modulation/Frequency Modulation/Phase Modulation".

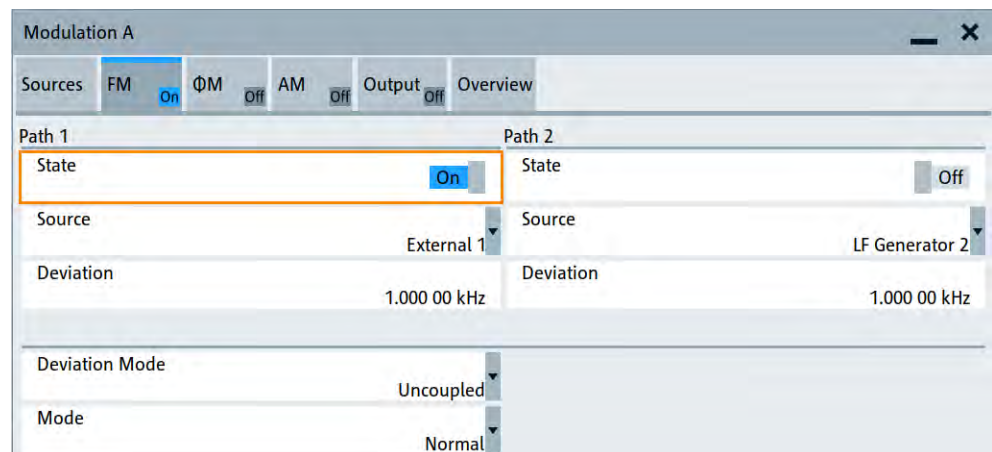

The "FM", "Φ" and "AM" tabs contain the parameters per modulation type.

Since you need to determine an LF signal source for all modulations, "Source" and "State" are described in general. These parameters apply to the modulation modes AM, FM and ΦM. The following description explains the specific settings for the appropriate modulation modes.

**State**

Option: R&S SMW-B9 - enabled in "System Config" > "Mode" = "Standard".

Option: R&S SMW-B10 - enabled in "System Config" > "Mode" = "Standard"/"Advanced".

Activates a modulation.

**Note:** Some modulations exclude each other and cannot be performed simultaneously. For more information, refer to the specifications document.

Remote command:

[ :SOURce<hw> ] :AM<ch> :STATe on page 1039

[ :SOURce<hw> ] :FM<ch> :STATe on page 1043

[ :SOURce<hw> ] :PM<ch> :STATe on page 1048

### Source

Selects the LF signal source.

You can vary the signal sources for each of the modulations.

"LF Generator 1/2"

Selects one or both of the internally generated LF signals.

"External 1/2"

Selects an externally supplied LF signal.

"Noise Generator"

Selects the internally generated noise signal.

"Internal Baseband"

Option: R&S SMW-B9

The I component of the internal baseband signal is used as modulation signal source for the frequency (FM) or phase (PhiM) modulations.

Consider the following interdependency:

- The I/Q modulator in the same signal path cannot be used simultaneously and is thus disabled.
- The FM and the PhiM cannot be used as source for the LF output.
- The FM and PhiM sources in the second path are disabled, too.
- The second path is disabled and cannot be activated.

Remote command:

[ :SOURce<hw> ] :AM<ch> :SOURce on page 1039

[ :SOURce<hw> ] :FM<ch> :SOURce on page 1044

[ :SOURce<hw> ] :PM<ch> :SOURce on page 1048

### FM settings

The following settings are dedicated to FM.

#### Deviation ← FM settings

Sets the frequency modulation deviation in Hz.

The maximal deviation depends on the RF frequency and the selected modulation mode.

Maximal possible deviation is selected automatically, if one of the following applies:

- The selected deviation is too high for the particular frequency
- The selected frequency is outside of the range where deviation is possible.

A warning message indicates this situation, too.



For more information, refer to the specifications document.

Remote command:

`[ :SOURce<hw> ] :FM<ch> [ :DEViation ]` on page 1044

#### Deviation Mode ← FM settings

Enables you to couple the LF signal of both paths and determines the mode for fixing the total deviation.

The total deviation is the sum of both paths. When the sum is exceeded, the R&S SMW200A reports a settings conflict, but does not change the settings.

- |               |  |
|---------------|--|
| "Uncoupled"   | Enables you to adjust the deviation for each path independently.   |
| "Fixed Total" | Couples the deviation of both paths in per Hz. If you change the deviation of any path, the R&S SMW200A automatically adjusts the value of the other path. The sum always results in the set <a href="#">Total Deviation</a> . |
| "Fixed Ratio" | Couples the deviation ratio of both paths. If you change the deviation of any path, the R&S SMW200A adjusts the value of the other path.   |

Remote command:

`[ :SOURce<hw> ] :FM:DEViation:MODE` on page 1045

#### Total Deviation ← FM settings

Sets the sum of the signal deviation for path 1 and path 2 in Hz when using combined sources in [Deviation Mode > Fixed Total](#).

[Deviation](#) of both paths always sum up to the value of the total deviation.

Behavior when changing any depth settings:

- Changing the total deviation adjusts the deviation of both paths proportionally.
- Changing the deviation of one path adjusts the deviation of the other path. The sum always results in the set total deviation.

Remote command:

`[ :SOURce<hw> ] :FM:DEViation:SUM` on page 1045

#### Ratio Path2/Path1 ← FM settings

Sets the deviation ratio (path2 to path1) in percent.

#### Example:

If the deviation in path1 is 10 kHz and the ratio is 50%, the deviation in path 2 is automatically set to 5 kHz.

Remote command:

`[ :SOURce<hw> ] :FM:RATio` on page 1045

#### Mode ← FM settings

Selects the mode of the frequency modulation.

- |             |  |
|-------------|--|
| "Normal"    | The maximum range for modulation bandwidth is available.   |
| "Low Noise" | Phase modulation with phase noise and spurious characteristics close to CW mode. The range for modulation bandwidth and FM deviation is reduced. |

For more information, refer to the specifications document.

Remote command:

`[ :SOURce<hw> ] :FM:MODE` on page 1046

### PhiM settings

The following settings are dedicated to PhiM ("ΦM").

#### Deviation ← PhiM settings

Sets the phase modulation deviation in radians or degrees.

The maximal deviation depends on the RF frequency and the selected modulation mode.

For more information, refer to the specifications document.

Maximal possible deviation is selected automatically, if one of the following applies:

- The selected deviation is too high for the particular frequency
- The selected frequency is outside of the range where deviation is possible.

A warning message indicates this situation, too.

Remote command:

`[ :SOURce ] :PM<ch>[:DEViation]` on page 1051

#### Deviation Mode ← PhiM settings

Enables you to couple the LF signal of both paths and determines the mode for fixing the total deviation.

The deviation sum 2 rad at a maximum. When the sum is exceeded, the R&S SMW200A adjusts the settings automatically.

"Uncoupled" Enables you to adjust the deviation for each path independently.

"Fixed Total" Couples the deviation of both paths. If you change the deviation of any path, the R&S SMW200A automatically adjusts the value of the other path. The sum always results in the set [Total Deviation](#).

"Fixed Ratio" Couples the deviation ratio of both paths. If you change the deviation of any path, the R&S SMW200A adjusts the value of the other path.

Remote command:

`[ :SOURce<hw> ] :PM:DEViation:MODE` on page 1049

#### Total Deviation ← PhiM settings

In [Deviation Mode = Fixed Total](#), sets the sum of the signal deviation for path 1 and path 2.

[Deviation](#) of both paths always sum up to the value of the total deviation.

Behavior when changing any depth settings:

- Changing the total deviation adjusts the deviations of both paths proportionally.
- Changing the deviation of one path adjusts the deviation of the other path. The sum always results in the set total deviation.

Remote command:

`[ :SOURce<hw> ] :PM:DEViation:SUM` on page 1050

#### Ratio Path2/Path1 ← PhiM settings

Sets the deviation ratio (path2 to path1) in per cent.

**Example:**

If the deviation in path1 is 10 rad and the ratio is 50%, the deviation in path 2 is automatically set to 5 rad.

Remote command:

`[ :SOURce<hw> ] :PM:RATio` on page 1050

**Mode ← PhiM settings**

Selects the mode of the phase modulation.

"High Bandwidth"

The maximum range for modulation bandwidth and PhiM deviation is available.

However, phase noise increases at low frequencies, and the range of PhiM deviation is limited. This mode is suitable if you process high frequencies.

"High Deviation"

The maximum range for PhiM deviation is available.

Phase noise is improved for low frequencies compared to the default mode. The range for modulation frequency is limited.

This mode is suitable for low modulation frequencies and/or high PhiM deviation.

"Low Noise"

Frequency modulation with phase noise and spurious characteristics close to CW mode. The range for modulation bandwidth and FM deviation is reduced.

For more information, refer to the specifications document.

Remote command:

`[ :SOURce<hw> ] :PM:MODE` on page 1049

**AM settings**

Provides the settings for amplitude modulation.

**Depth ← AM settings**

Determines the depth of the modulation signal in percent.

The depth is limited by the maximum peak envelope power (PEP).

Remote command:

`[ :SOURce<hw> ] :AM<ch> [ :DEPTTh ]` on page 1040

**Sensitivity ← AM settings**

Sets the input sensitivity of the external modulation signal.

Remote command:

`[ :SOURce<hw> ] :AM<ch> :SENSitivity` on page 1041

**Deviation Mode ← AM settings**

Enables you to couple the LF signal of both paths and determines the mode for fixing the total deviation.

The deviation sum of both paths is 100% in total. When the sum is exceeded, the R&S SMW200A reports a settings conflict, but does not change the settings.

- "Uncoupled" Enables you to adjust the deviation depth for each path independently.
- "Fixed Total" Couples the deviation depth of both paths in per cent. If you change the depth of any path, the R&S SMW200A automatically adjusts the value of the other path. The sum always results in the set **Total Depth**.
- "Fixed Ratio" Couples the deviation ratio of both paths. If you change the depth of any path, the R&S SMW200A adjusts the value of the other path.

Remote command:

`[ :SOURce<hw> ] :AM:DEVIation:MODE` on page 1040

#### **Total Depth ← AM settings**

Sets the sum of the signal **Depth** for path 1 and path 2 in per cent when using combined sources and **Deviation Mode > Fixed Total**.

Provided both signal paths are turned on, the depth of both paths always sum up to the value of the total depth.

Behavior when changing any depth settings:

- Changing the total depth adjusts the depths of both paths proportionally.
- Changing the depth of one path adjusts the depth of the other path. The sum always results in the set total depth.

Remote command:

`[ :SOURce<hw> ] :AM:DEPTH:SUM` on page 1040

#### **Ratio Path2/Path1 ← AM settings**

Sets the deviation ratio of the signal depth for path 2 to path 1 in per cent when using combined sources.

Remote command:

`[ :SOURce<hw> ] :AM:RATio` on page 1041

### **8.11.4.3 Pulse generator settings**

Access:

- ▶ Select "RF" > "Analog Modulation" > "Pulse Generator".

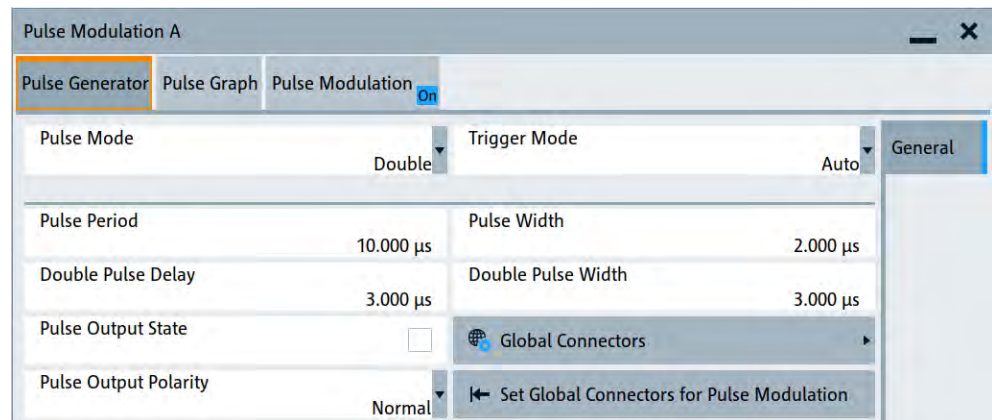

The "Pulse Generator" tab contains the settings for creating the pulse modulation signal internally.

### Pulse generator > general settings

Access:

- ▶ Select "RF" > "Analog Modulation" > "Pulse Generator".

Settings:

Pulse Mode.....	565
Trigger Mode.....	565
Pulse Period.....	567
Pulse Width.....	567
Double Pulse Width.....	567
Pulse Delay.....	568
Double Pulse Delay.....	568
Pulse Output State.....	568
Pulse Output Polarity.....	568
Set Global Connectors for Pulse Modulation.....	568

#### Pulse Mode

Sets the operating mode of the pulse generator. Depending on the selection, the instrument displays the associated parameters.

- "Single" Generates a single pulse in one pulse period.
- "Double" Generates two pulses in one pulse period.

Remote command:

[ : SOURce<hw> ] : PULM:MODE on page 1052

#### Trigger Mode

Selects between continuous triggering or triggering initiated by a trigger event from an external signal.

- "Auto" Generates the internal modulation signal continuously.
- "Ext Single" Generates a single pulse signal, triggered by an external signal.

"Ext Triggered" Generates the pulse signal each time an external trigger event occurs.

**Example: Generation of double pulse signal ("Pulse Mode = Double") using "Trigger Mode = Ext Triggered"**

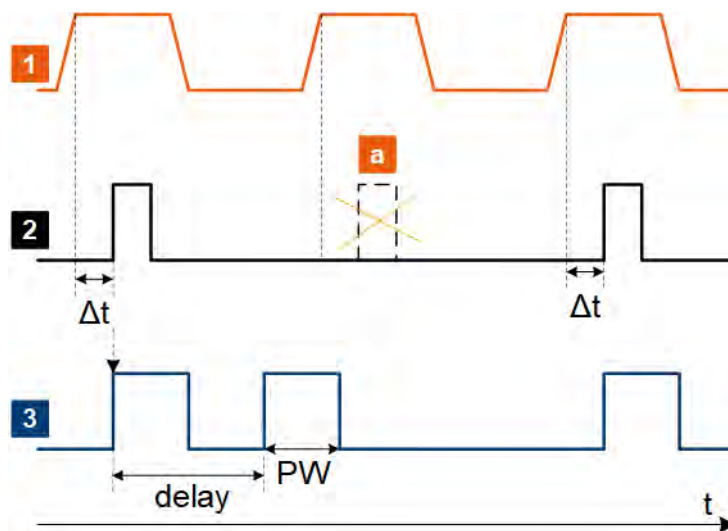

- 1 = External trigger signal input with "Trigger Input Polarity = Normal" (the positive slope is active)
- 2 = Sync signal
- 3 = Pulse signal
- a = Trigger signal during double pulse generation is without effect
- $\Delta t$  = Trigger delay between the trigger and the sync signal start.
- delay = "Double Pulse Delay = 200 ns"; the first pulse starts without a delay
- PW = "Double Pulse Width = 100 ns"

"Ext Gated" Generates the signal triggered by an external gate signal.

**Example: Generation of single pulse signal ("Pulse Mode = Single") using "Trigger Mode = Ext Gated"**

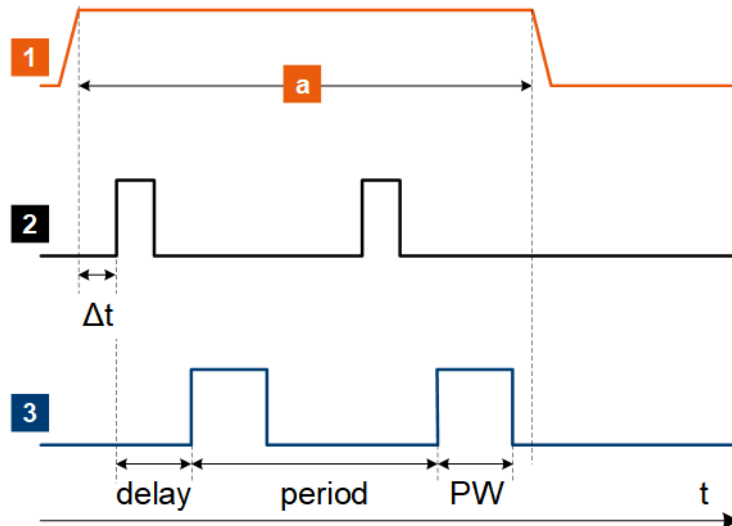

- 1 = External trigger signal input with "Trigger Input Polarity = Normal" (the positive slope is active)
- 2 = Sync signal
- 3 = Pulse signal
- $\Delta t$  = Trigger delay between the trigger and the sync signal start; see specifications document
- delay = "Pulse Delay = 100 ns"
- PW = "Pulse Width = 100 ns"
- period = "Pulse Period = 300 ns" (time between the pulse start of two consecutive pulses)
- a = Gate active duration (pulses are generated during the gate active part)

For more information, refer to the specifications document.

Remote command:

`[ :SOURce<hw> ] :PULM:TRIGger:MODE` on page 1053

#### Pulse Period

Sets the repetition rate of the generated pulse signal.

Remote command:

`[ :SOURce<hw> ] :PULM:PERiod` on page 1053

#### Pulse Width

Sets the pulse duration of the generated pulse signal.

**Note:** The pulse width must be at least 20 ns less than the set pulse period.

Remote command:

`[ :SOURce<hw> ] :PULM:WIDTHh` on page 1053

#### Double Pulse Width

Sets the width of the second pulse.

Remote command:

`[ :SOURce<hw> ] :PULM:DOUBle:WIDTh` on page 1054

#### **Pulse Delay**

Sets the pulse delay. The pulse delay determines the time that elapses after a trigger event before pulse modulation starts. The pulse delay is not effective for double pulse generation.

Remote command:

`[ :SOURce<hw> ] :PULM:DELay` on page 1053

#### **Double Pulse Delay**

Sets the delay from the start of the first pulse to the start of the second pulse.

Remote command:

`[ :SOURce<hw> ] :PULM:DOUBle:DELay` on page 1054

#### **Pulse Output State**

Activates the output of the pulse modulation signal.

Remote command:

`[ :SOURce<hw> ] :PGENerator:OUTPut [ :STATe ]` on page 1263

#### **Pulse Output Polarity**

Sets the polarity of the pulse output signal.

Remote command:

`[ :SOURce<hw> ] :PGENerator:OUTPut:POLarity` on page 1263

#### **Set Global Connectors for Pulse Modulation**

Routes the pulse input signal and the pulse output signal to a global connector.

By default, routes the pulse input to "USER 4" ("Signal" > "Pulse In") and the pulse output to "USER 5" ("Signal" > "Pulse Out").

For a two-path instrument, the signals correspond to the related path "A" or "B".

See also [Section 12.2, "Configuring local and global connectors"](#), on page 742.

Remote command:

`:SOURce<hw>:PGENerator:SET:GLB:CONNectors` on page 1262

#### **8.11.4.4 Pulse graph**

Access:

- ▶ Select "RF" > "Analog Modulation" > "Pulse Modulation > Pulse Graph".

The pulse graph is the graphical representation of the current pulse signal.





The height of the bars corresponds to the selected amplitude of the pulse signal.

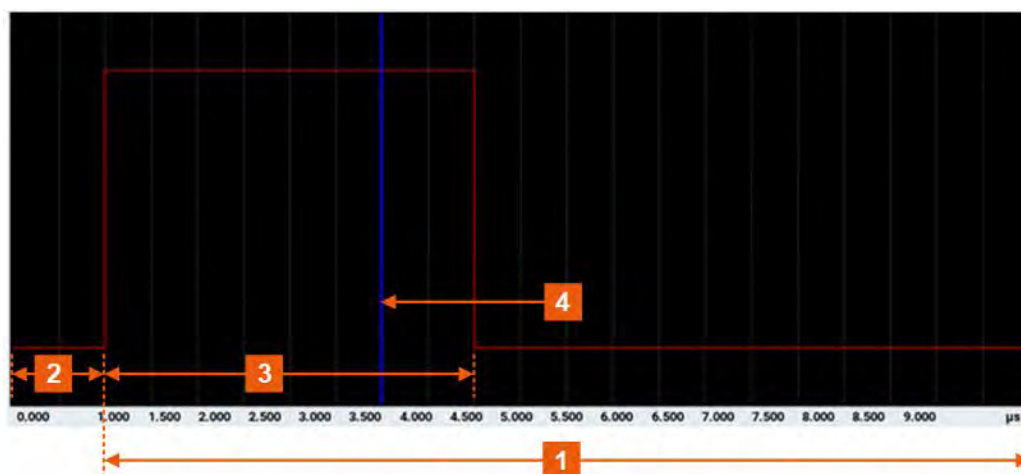

**Figure 8-18: Pulse Graph - single pulse**

- 1 = Pulse Period
- 2 = Pulse Delay
- 3 = Pulse Width
- 4 = Pulse Zoom Position

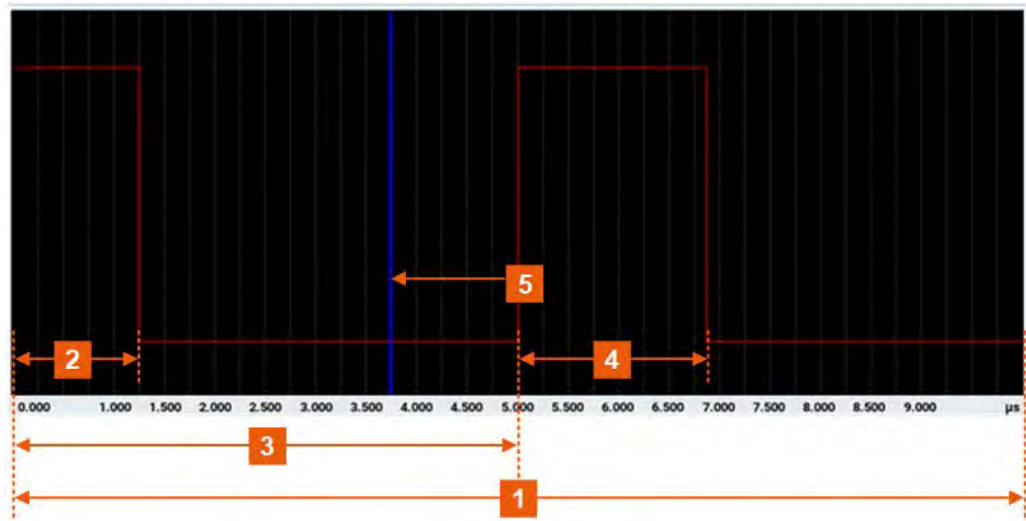

**Figure 8-19: Pulse Graph - double pulse**

- 1 = Pulse Period
- 2 = Pulse Width
- 3 = Double Pulse Delay
- 4 = Double Pulse Width
- 5 = Pulse Zoom Position

### Settings:

Zooming..... 570

### Zooming

You can zoom into the diagram to visualize the graph in more detail:

- "Zoom Position": Sets the focus on the time axis where to enlarge the graph.
- "Zoom In": Enlarges the graph at the selected position.
- "Zoom Out" for the reverse operation.

#### 8.11.4.5 AM, FM and PhiM modulation sources

Access:

- ▶ Select "RF" > "Analog Modulation" > "Sources".

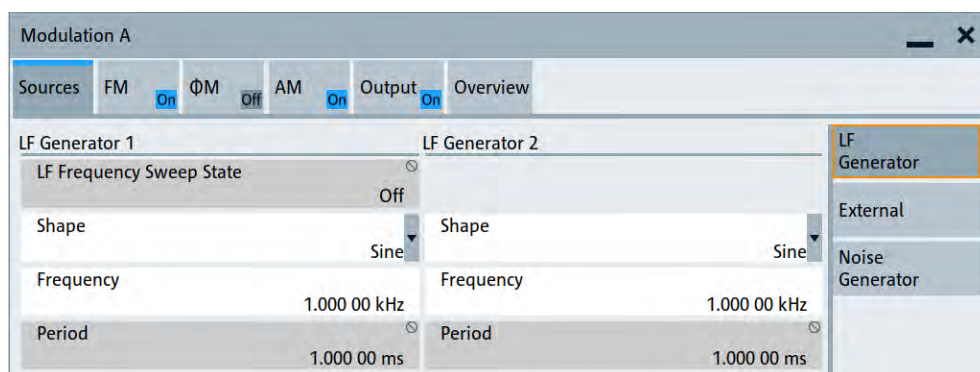

In the "Sources" tab, you can configure an LF modulation signal for performing analog modulations. It includes the setting parameters of the internal LF- and multi-function generators, the noise generator, and an external signal source. To select an external signal, you can directly access the settings of the [Connectors](#) dialog.

The remote commands required to define these settings are described in [Section 14.19.12, "SOURce:LFOutput subsystem"](#), on page 1227.

### Source > LF generator settings

Access:

- ▶ Select "RF" > "Analog Modulation" > "Sources" > "LF Generator".

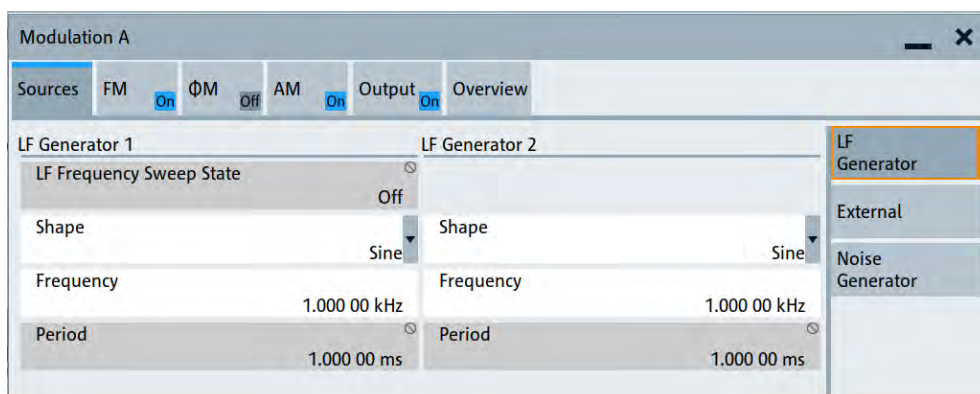

You can use the internal LF signal as modulation signal source for any of the analog modulations. The LF signal applies to all modulations which use the internal modulation signal. Therefore, any modification of the LF signal influences immediately all currently active modulations.

### Settings:

State (LF frequency sweep).....	572
Shape.....	572
Frequency.....	572
Period.....	572

Pulse Width.....	572
Pulse Duty Cycle.....	572
Triangle Rise.....	573
Trapezoid Rise / Fall.....	573
Trapezoid High.....	573

### State (LF frequency sweep)

Status of the LF frequency sweep signal.

You find this parameter in two dialogs:

- "LF Frequency Sweep" turns on/off the signal generation.  
See [Sweep mode settings](#) for access.
- "Analog Modulation Sources" displays the current state (read-only). If it is turned on, this dialog provides the varying sweep frequency, see [Current Frequency](#).

**Note:** Active RF frequency, RF level or RF combined sweep modes deactivate the LF sweep or List mode and vice versa.

Remote command:

[\[:SOURce<hw>\]:LFOutput:FREQuency:MODE](#) on page 1231

### Shape

Option: R&S SMW-K24.

Selects the waveform shape of the LF generator signal.

Remote command:

[\[:SOURce<hw>\]:LFOutput<ch>:SHAPE](#) on page 1234

### Frequency

Sets the frequency of the LF generator for sine signals.

Set the signal shape with the parameter [Shape](#).

Remote command:

[\[:SOURce<hw>\]:LFOutput<ch>:FREQuency](#) on page 1230

### Period

Sets the repetition rate of the generated LF signal for triangle, trapezoid or pulse shapes, see [Shape](#).

The period of sine signals is calculated from the selected [Frequency](#)

Remote command:

[\[:SOURce<hw>\]:LFOutput<ch>:SHAPE:TRAPeZe:PERiod](#) on page 1235

[\[:SOURce<hw>\]:LFOutput<ch>:SHAPE:TRIangle:PERiod](#) on page 1236

[\[:SOURce<hw>\]:LFOutput<ch>:SHAPE:PULSe:PERiod](#) on page 1234

### Pulse Width

Sets the pulse duration of the generated pulse signal.

Remote command:

[\[:SOURce<hw>\]:LFOutput<ch>:SHAPE:PULSe:WIDTh](#) on page 1234

### Pulse Duty Cycle

Sets the ratio between the pulse duration and the pulse period in percent.

Remote command:

[ :SOURce<hw> ] :LFOutput<ch>:SHAPE:PULSe:DCYClE on page 1234

### Triangle Rise

Sets the time required for the triangle signal to change from low level to high level.

See also [Modulation signal waveforms](#).

Remote command:

[ :SOURce<hw> ] :LFOutput<ch>:SHAPE:TRIangle:RISE on page 1236

### Trapezoid Rise / Fall

Sets the time required for the trapezoid signal to change from low level to high level, and vice versa.

See [Modulation signal waveforms](#).

Remote command:

[ :SOURce<hw> ] :LFOutput<ch>:SHAPE:TRAPeze:RISE on page 1235

[ :SOURce<hw> ] :LFOutput<ch>:SHAPE:TRAPeze:FALL on page 1235

### Trapezoid High

Sets how long the trapezoid signal is at high level.

Remote command:

[ :SOURce<hw> ] :LFOutput<ch>:SHAPE:TRAPeze:HIGH on page 1235

## Source > external settings

Access:

- ▶ Select "RF" > "Analog Modulation" > "Sources" > "External".

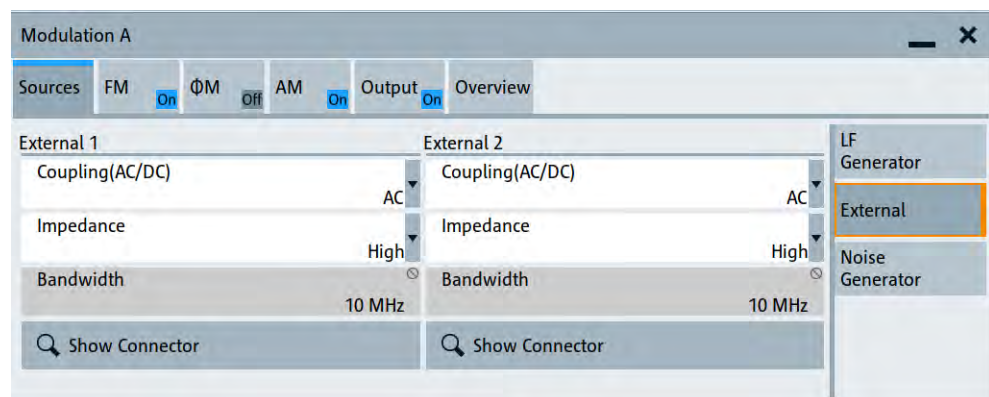

The "External" settings section contains all parameters required to configure the signal of an externally supplied LF signal.

**Settings:**

Coupling (AC/DC).....	574
Impedance.....	574
Bandwidth.....	574
Show Connector.....	574

**Coupling (AC/DC)**

Selects the coupling mode (AC or DC) for the external signal.

**Note:** You can set the coupling of the external modulation signal for AM, FM and  $\Phi$ M separately.

Remote command:

[ :SOURce<hw> ] : INPut : MODext : COUPling<ch> on page 1208

**Impedance**

Sets the impedance for the externally supplied signal.

Remote command:

[ :SOURce<hw> ] : INPut : MODext : IMPedance<ch> on page 1209

**Bandwidth**

Displays the maximum bandwidth of the external LF signal.

Remote command:

[ :SOURce ] : LFOutput<ch> : BANDwidth? on page 1230

**Show Connector**

Accesses a dialog that displays the physical location of the selected connector on the front/rear panel of the instrument.

A blinking LED on the front/rear panel indicates the selected connector, too (see [Section 12.2.2.4, "Status indicators"](#), on page 746).

**Source > noise generator settings**

Access:

- ▶ Select "RF" > "Analog Modulation" > "Sources" > "Noise Generator".

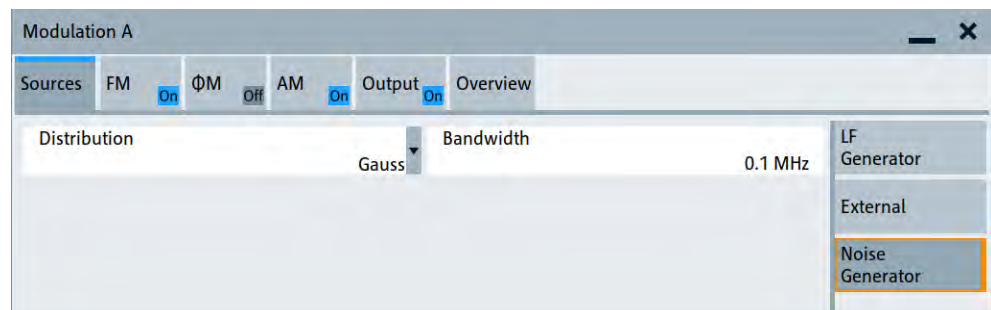

The "Noise Generator" settings contain all parameters to configure the signal of the internal noise generator.

**Settings:**

Distribution.....	575
Bandwidth.....	575

**Distribution**

Selects the distribution of the noise power density.

"Gauss" Generates the noise power according to a Gaussian distribution.

"Equal" Generates an evenly distributed noise.

Remote command:

[\[:SOURce<hw>\]:NOISe:DISTriBution](#) on page 1256

**Bandwidth**

Sets the noise bandwidth as distinct value.

You can set the bandwidth between 100 kHz and 10 MHz in 100 KHz steps.

The noise signal is generated within the set frequency bandwidth. The noise level in the frequency band is defined by "Noise Level (System Bandwidth)".

Remote command:

[\[:SOURce<hw>\]:NOISe:BANDwidth|BWIDth](#) on page 1255

**8.11.4.6 Output settings**

Access:

- ▶ Select "RF" > "Analog Modulation" > "Output".

**LF output settings**

Access:

- ▶ Select "RF" > "Analog Modulation" > "Output" > "LF Output".

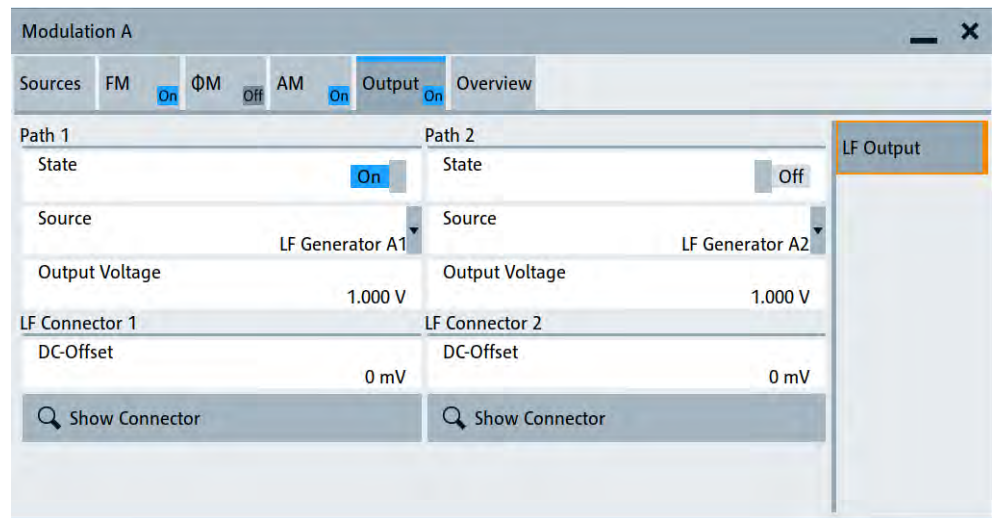

In the "LF Output" side tab, you can configure the signal at the LF output, determine the output voltage or add a DC offset.

### Settings:

State.....	576
Source.....	576
Output Voltage.....	576
DC-Offset.....	577
Show Connector.....	577

### State

Activates the output of the LF signal.

Remote command:

`[ :SOURce ] :LFOutput<ch> [ :STATe ]` on page 1232

### Source

Determines the LF signal to be synchronized of the corresponding path.

"LF Generator A1/2, B1/2"

Selects one of internally generated LF signals.

"AM A/B" Selects the AM signal.

"FM/ΦM A/B" Selects the signal also used by the frequency or phase modulations.

"Noise Generator A/B"

Selects the internally generated noise signal.

"External 1/2" Selects an externally supplied LF signal

Remote command:

`[ :SOURce ] :LFOutput<ch> :SOURce` on page 1233

### Output Voltage

Sets the peak to peak voltage of the selected LF output source.

This value, e.g. +1 V to -1 V refers to 50 Ohm at the RF output with high termination impedance at the LF output.



Remote command:

`[ :SOURce ] :LFOutput<ch>:VOLTage` on page 1233

### DC-Offset

Adds a DC offset to the LF output signal.

Remote command:

`[ :SOURce ] :LFOutput<ch>:OFFSet` on page 1232



### Show Connector

Accesses a dialog that displays the physical location of the selected connector on the front/rear panel of the instrument.

A blinking LED on the front/rear panel indicates the selected connector, too (see [Section 12.2.2.4, "Status indicators"](#), on page 746).

### Noise level settings

Access:

1. Select "RF" > "Analog Modulation" > "Output" > "LF Output".
2. Set "Source" > "Noise Generator".
3. Select "Output" > "Noise Level".

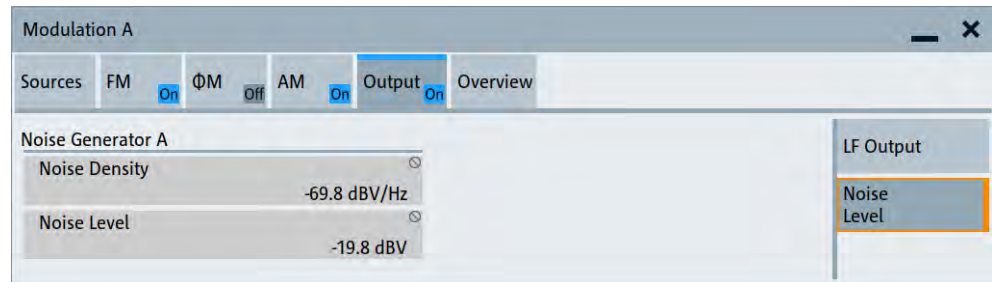

In the "Noise Level" side tab, you can set the signal level and noise density.

### Settings:

<a href="#">Noise Density</a> .....	577
<a href="#">Noise Level</a> .....	577

### Noise Density

Indicates the level of the noise signal for a bandwidth of 1 Hz (relative).

Remote command:

`[ :SOURce<hw> ] :NOISe:LEVel<ch>:RELative?` on page 1256

### Noise Level

Indicates the level of the noise signal per Hz within the total bandwidth (absolute).

Remote command:

`[ :SOURce<hw> ] :NOISe:LEVel<ch>[:ABSolute]?` on page 1256

### 8.11.4.7 Overview

Access:

- ▶ Select "RF" > "Analog Modulation" > "Modulations" > "Overview".

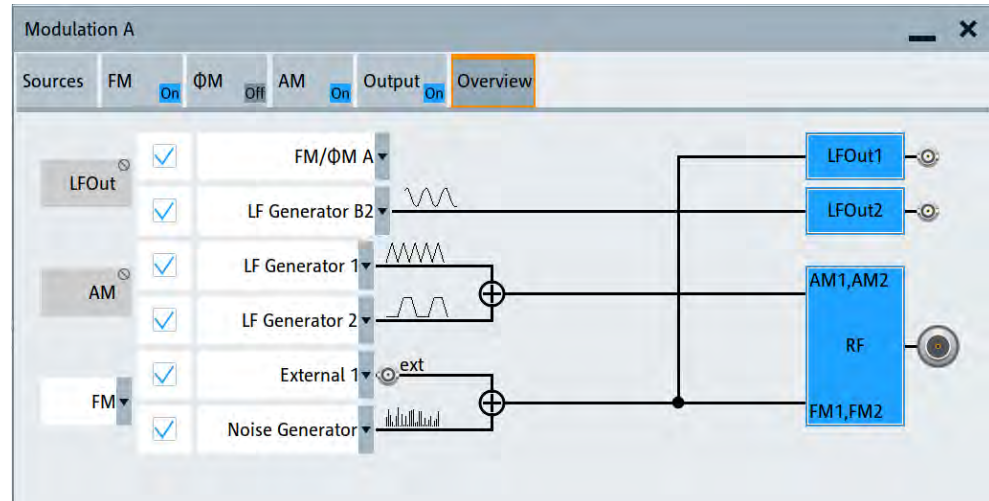

- Blue color = Active output signal (AM and FM)
- Gray color = Inactive output signal (LF Out)
- Miniature graph = Indicates an active source
- Connectors = Indicate a connector (e.g. external signal) is involved in the path of the signal

The "Overview" tab is an interactive diagram that indicates the active modulations and the signal being output.

Here you can:

- Select the output signal ("LF Out") per path; the setting acts as the parameter "LF Output Source"
- Select the source for each modulation and modulation path; the setting acts as the parameter "Source"
- Activate modulation per path; the setting acts as the parameter "State"  
To generate a two-tone signal composed form the two paths of the same modulation type, activate both paths.
- Activate "FM" or "PhiM"; the two modulations are mutually exclusive.

See:

- [Section 8.11.2.3, "Assigning the LF signal to the output"](#), on page 549 for details
- [Section 8.11.4, "Modulation settings"](#), on page 557 for description of the related settings

#### Settings:

LFOut.....	579
AM.....	579
FM/PhiM.....	579

**LFOut**

Label for the LF output settings in the overview.

Remote command:

n.a.

**AM**

Label for the amplitude modulation settings in the overview.

Remote command:

n.a.

**FM/PhiM**

Selects the modulation signal to be assigned to the output. You can assign the frequency or phase modulated signal.

Remote command:

n.a.

## 8.11.5 How to generate a modulated signal

### 8.11.5.1 How to generate an amplitude modulated signal

The following examples use the internal LF generator.

**To set the frequency and level of the RF signal**

1. Press [PRESET] to start from a defined state.
2. In the status bar, set "Frequency = 2 GHz".
3. Set "Level = -20 dBm".

**To configure the modulation signal (LF generator)**

1. Select "RF" > "Analog Modulation" > "Modulation Source".
2. In the "Sources" tab, select "Shape > Sine".
3. Set "Frequency = 20 kHz".

The period is calculated automatically and indicates "Period = 50.00 µs".

**To configure the amplitude modulation settings**

1. In "Modulation" dialog, select the "AM" tab.
2. Set "Source = LF Generator1"
3. Set "Depth = 30%"
4. Select "State = I" to activate the modulation.
5. Set "RF > On" to enable signal output.

### 8.11.5.2 How to generate a pulse modulated signal

The following example uses the internal pulse generator.

#### To set the frequency and level of the RF signal

1. Press [PRESET].
2. In the status bar, set "Frequency = 4 GHz".
3. Set "Level = -25 dBm".

#### To configure the pulse generator

1. Select "RF" > "Analog Modulation" > "Pulse Generator".
2. Select "Pulse Mode = Double".
3. Set "Pulse Period = 10 us".
4. Set "Pulse Width = 2 us".
5. Set "Double Pulse Width = 1.2 us".
6. Set "Double Pulse Delay = 4.5 us".
7. Activate "Pulse Output State".
8. Set "Trigger Mode = Auto".

In the "Pulse Graph" tab, you can view the generated pulse signal graphically.

#### To enable pulse modulation

1. Select the "Pulse Modulation" tab.
2. Set "State = I" to activate pulse modulation.
3. Set "RF > On" to enable signal output.

## 8.12 Improving level performance

To adjust the RF output signal to specific needs in your application optimally, the R&S SMW200A provides different functions:

- **Attenuator**

The R&S SMW200A is equipped with a step attenuator that enables you to vary the amplitude of the RF signal in a wide range. It is characterized by low VSWR (voltage standing wave ratio) over the full level and frequency range, and provides highest level accuracy and noise suppression.

See [Section 8.12.1, "Attenuator"](#), on page 581.

- **Automatic Level Control (ALC)**

The automatic level control system ensures stable RF signals with highest absolute level accuracy over temperature and time.

See [Section 8.12.2, "ALC - automatic level control"](#), on page 584.

- **User correction (UCOR)**

The user correction function allows you to compensate frequency responses of external setups (e.g. losses of cables) and achieve a stable input signal over frequency directly at the DUT.  
See [Section 8.12.3, "User correction"](#), on page 588.
- **Power sensors**

The R&S NRP power sensors support RF signal level optimization by determining the attenuation characteristics of downstream devices or cables, or by monitoring the RF signal level at the output directly. The R&S SMW200A uses the readings of a sensor for compensation of losses and thus improving the accuracy of the RF signal level.  
You can configure the measurement parameters of a power sensor directly in the R&S SMW200A and monitor its readings, including calibration.  
See:

  - [Section 8.12.4, "Using power sensors"](#), on page 600
  - [Section 8.12.5, "Improving the RF signal performance"](#), on page 617
  - [Section 8.12.4.2, "NRP power viewer"](#), on page 602
  - [Section 8.12.4.3, "NRP power control"](#), on page 605
  - [Section 8.12.4.4, "NRP sensor configuration"](#), on page 610
  - [Section 8.12.4.5, "NRP sensor mapping"](#), on page 615

## 8.12.1 Attenuator

### About the attenuator

The step attenuator is either an electronic or mechanical device. Instruments with frequency options up to 13 GHz use an electronic step attenuator, providing fast and wear free level settings. Instruments capable to generate higher frequency signals use mechanical step attenuators.

According to the requirements of your application, you can select different attenuator characteristics.

The following are examples of test requirements and the corresponding configuration:

- **Automatic configuration**

Select standard operation mode ("Auto"), in which the generator adjusts the attenuation of the RF output signal automatically.
- **DUT tests under low signal to noise conditions**

Low output power is suitable to test the behavior of a DUT under low signal to noise conditions.
- **Uninterrupted level settings with constant VSWR**

A fix attenuation value is required for obtaining uninterrupted level settings with constant VSWR.  
The configuration "RF Off Mode > Unchanged" ensures that constant VSWR is maintained if you turn the signal off and on again.
- **Highest level accuracy**

Enter the target level value in "Fixed" mode and activate ALC (automatic level control).

In this operating mode, the generator adjusts the output level whenever the frequency or level setting changes.

- Noise sensitive applications  
The parameter "RF OFF Mode > Full Attenuation" sets maximum attenuation and thus suppresses noise when you turn off the RF signal.



### Interactions and characteristics

- The spectral purity of the RF output signal decreases with high attenuation.
- Fixed mode is effective when automatic level control is activated (**ALC State = On**).
- The setting of the **RF OFF Mode > Full Attenuation** has priority over the RF level **Mode > Fixed or Manual**, regardless of the selected settings characteristics.

#### 8.12.1.1 Attenuator settings

Access:

- ▶ Select "RF" > "RF Level" > "Level > Attenuator".

In the "Attenuator" dialog, you can select the operating mode of the step attenuator, the instrument is equipped with.

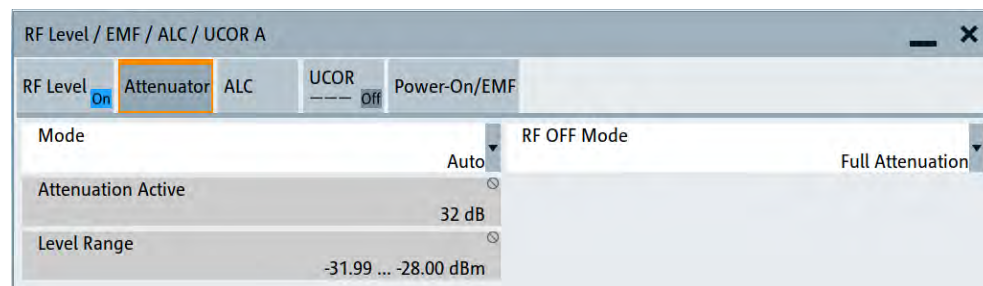

The remote commands required to define these settings are described in [Section 14.16, "OUTPut subsystem"](#), on page 945 and [Section 14.19.18, "SOURce:POWer subsystem"](#), on page 1264.

### Settings

<a href="#">Mode</a> .....	582
<a href="#">Attenuation</a> .....	583
<a href="#">Attenuation Active</a> .....	583
<a href="#">Level Range</a> .....	583
<a href="#">RF OFF Mode</a> .....	583

### Mode

Determines the operating mode of the step attenuator.

**Note:** **RF OFF Mode > Full Attenuation** has higher priority than "Fixed" or "Manual".

"Auto"	Adjusts the attenuator settings automatically.
"Fixed"	Fixes the attenuator and amplifier paths for the current RF level and provides signal output with constant output VSWR. The resulting level range is indicated under <b>"Level Range"</b> on page 489. This mode is coupled with ALC, and therefore only effective when ALC is enabled.
"Manual"	Allows you to set the <b>Attenuation</b> . The user-specified nominal attenuation is useful for instruments equipped with a mechanical step attenuator. Similar to "Fixed" mode, relays and amplifier stages keep the specified value, providing interruption-free signal output level.

Remote command:

`:OUTPut<hw>:AMODE` on page 946

### Attenuation

Sets the nominal attenuation of the RF signal in **Mode > Manual**.

Remote command:

`[ :SOURce<hw> ] :POWer:ATTenuation` on page 1269

### Attenuation Active

Displays the current level attenuation value in **Mode > Auto | Fixed**.

Remote command:

`[ :SOURce<hw> ] :POWer:AATTenuation?` on page 1269

### Level Range

Shows the interruption-free range of the level that you can use in the selected mode.

Remote command:

`:OUTPut<hw>:AFIXed:RANGe:LOWer?` on page 947

`:OUTPut<hw>:AFIXed:RANGe:UPPer?` on page 947

### RF OFF Mode

Determines the state of the step attenuator, when the RF signal is switched off.

The setting is not affected by an instrument preset ([PRESET] key or \*RST) and the "Save/Recall" function. It is reset only by factory preset.

"Unchanged" Freezes the setting of the step attenuator.  
Use this mode if a constant VSWR (Voltage Standing Wave Ratio) is required.

"Full Attenuation"  
Switches to the maximum attenuation.  
Use this mode for applications that require a high level of noise suppression.  
**Note:** "Full Attenuation" has higher priority than the RF level modes **Mode > Fixed or Manual**.

Remote command:

`[ :SOURce<hw> ] :POWer:ATTenuation:RFOff:MODE` on page 1270

### 8.12.1.2 Reverse power protection

The instrument is equipped with a reverse power protection circuit.

The reverse power protection is tripped when the power of signals reflected from the load or external signals applied to the RF output get too high. A relay opens and interrupts the internal connection to the RF output. This condition is indicated in the status bar by the "Overload" status message.

#### Overload

If an "Overload" status message is indicated in the status bar, perform the following:

- Remove the cause for the overload
- Press the [RF ON/OFF] key to reset the overload protection

The RF input is activated when the overload protection is reset.

Remote command:

`:OUTPut<hw>:PROTection:TRIPped?` on page 948

`:OUTPut<hw>:PROTection:CLEar` on page 948

`:OUTPut<hw>:PROTection:STATe` on page 948

### 8.12.2 ALC - automatic level control

The R&S SMW200A is equipped with an automatic level control (ALC) unit to obtain best RF level accuracy.

#### About ALC

ALC is an adaptive control system to stabilize the RF output level. It continuously monitors the current level and adjusts it to keep a steady state over temperature and time.

ALC is active in almost all applications by default. It is not active for frequencies below 200 kHz and if the optimization mode (IQ modulation) is different than "FAST".

Also note that ALC can detect incorrect values in **multi-transmitter** test setups. If multiple generators are coupled, reverse power can affect the ALC readings, which leads to an incorrect RF output power.

#### ALC states and their effects

The following description basically explains the ALC states and their principle of operation:

- "Auto"  
Adjusts the output level to the operating conditions automatically. ALC is active in almost all operating modes.
- "On"  
Activates the internal level control permanently, regardless of the operating conditions.  
If you also set "Attenuator Mode > Fixed", the instrument recalibrates every level and frequency setting, resulting in high-level accuracy.



**Note:** This mode is not useful for pulse modulation with narrow pulses and low repetition rates, since the automatic level control cannot settle in time. Set ALC "Auto" or "Table & On" instead.

- "Off (Sample & Hold)"  
Deactivates ALC, but still allows you to maintain a constant output level. The R&S SMW200A switches briefly in the CW mode and enables ALC to adjust the level to the set target value. The instrument freezes this setting, turns off ALC again, and switches back to the operating mode.
- "Sample & On"  
Initially the level control circuit uses a sample process to settle to the current level. When settled, it continues level control with highest level accuracy.
- "Off (Table)"  
Deactivates internal level control loop. The instrument calculates every level setting using the attenuation values from the internal (ALC) table. Level attenuation between two table values is done with linear interpolation. This mode enables you to perform a fast and strictly monotonic, but not quite as precise level adjustment. This mode achieves fastest setting times, since the output signal is not interrupted by the measurement, and also not disturbed.
- "Table & On"  
Starts with the associated value of the internal level table and then activates the automatic level control. This mode achieves maximum level accuracy and fast setting times.

The R&S SMW200A displays the level control setting as a status message in the info line.

How to: See [Section 8.12.2.3, "How to enable the ALC"](#), on page 588.

### 8.12.2.1 Required options

The equipment layout for automatic level control includes:

- Option frequency (e.g. R&S SMW-B1003/-B2003)

### 8.12.2.2 ALC settings

Access:

- ▶ Select "RF" > "RF Level" > "Automatic Level Control".

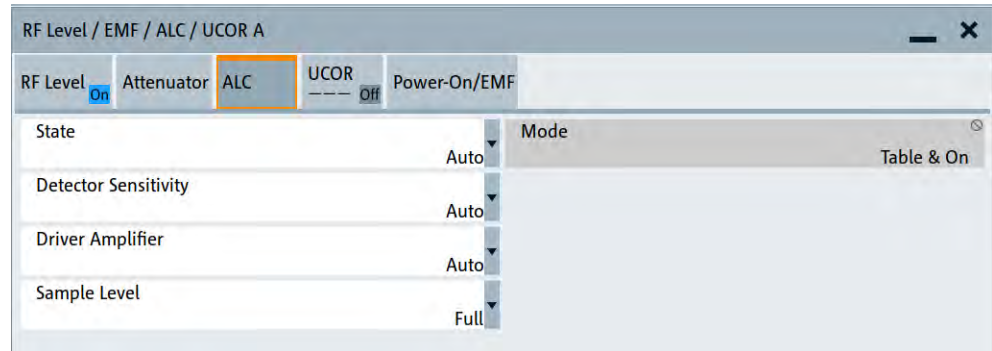

In the "ALC" dialog, you can configure the settings for the automatic level control of the RF signal to achieve optimal accuracy.

The remote commands required to define these settings are described in [Section 14.19.18, "SOURCE:POWER subsystem"](#), on page 1264.

How to: See [Section 8.12.2.3, "How to enable the ALC"](#), on page 588.

#### Settings

<a href="#">State</a> .....	586
<a href="#">Mode</a> .....	587
<a href="#">Detector Sensitivity</a> .....	587
<a href="#">Driver Amplifier</a> .....	587
<a href="#">Sample Level</a> .....	588

#### State

Selects the internal level control mode.

"Auto"	Selects the most appropriate ALC mode automatically.
"On"	Activates ALC permanently.
"Off (Sample & Hold)"	Deactivates the ALC, but allows you to recalibrate the level at each frequency and level change. The value remains up to the next change.
"Sample & On"	Enables automatic level control after a short sample pulse.
"Off (Table)"	Controls the level using the attenuation values of the internal ALC table.

**"Table & On"**

Starts with the attenuation setting from the internal ALC table and continues with automatic level control.

For further details on the individual settings, an overview of the functionality and details on what is to be considered, see ["ALC states and their effects"](#) on page 584.

**Note:**

The ALC modes "Off (Sample & Hold)" and "Sample & On" use a short sample pulse to set the level control. To adjust the level of this sample pulse, see ["Sample Level"](#) on page 588 in the ALC dialog. It does not consider any signal headroom, e.g. applied to a user defined ARB waveform.

How to: See [Section 8.12.2.3, "How to enable the ALC"](#), on page 588.

Remote command:

`[ :SOURce<hw> ] :POWer:ALC [ :STATe ]` on page 1267

**Mode**

In [ALC > State AUTO](#), the R&S SMW200A indicates the currently active ALC mode that is set automatically.

Remote command:

`[ :SOURce<hw> ] :POWer:ALC:MODE?` on page 1267

**Detector Sensitivity**

Determines the path of the internal level detector.

The level detector of the ALC has multiple paths distinguished by their sensitivity.

"Auto"	Selects the detector path automatically, according to the given level. This mode is the recommended operation mode.
"Low"	Selects the detector path with low sensitivity. This setting is intended for signals with high internal electronic levels.
"Med"	Selects the path with medium sensitivity. This setting corresponds to normal mode. It is intended for signals with medium internal electronic levels.
"High"	Selects the detector path with high sensitivity, intended for signals with low internal electronic levels.
"Fix"	Fixes the last set sensitivity setting.

Remote command:

`[ :SOURce<hw> ] :POWer:ALC:DSENSitivity` on page 1268

**Driver Amplifier**

Selects the switching state of the driver amplifier, that means the switchable amplifier or step attenuator at the output.

"Auto"	Switches the step attenuator automatically.
"On/Off"	The driver amplifier is switched on, or off respectively.

**"On (maximum Gain)"**

The driver amplifier is switched on.

The R&S SMW200A supplies the maximum level at the output within the frequency range 6 GHz to 10 GHz.

**Note:** In this mode, the harmonics increase.

**"Fix"**

Fixes the last setting.

The **Readjust** button switches the driver amplifier state first to automatic, calculates all level settings and then resets to fix.

Remote command:

`[ :SOURce<hw> ] :POWer:ALC:DAMPlifier` on page 1268

**Sample Level**

Determines the level at the output of the instrument during the sample process.

How to: See [Section 8.12.2.3, "How to enable the ALC"](#), on page 588.

**"Full"**

Attenuates the sample level by the crest factor of the used I/Q modulation signal or 9 dB, whichever is lower. Additionally, an internal headroom of the signal is considered.

**"Attenuated"**

Sets an additional attenuation of 40 dB.

**"Minimum"**

Sets the attenuation to maximum.

Remote command:

`[ :SOURce<hw> ] :POWer:ALC:SLEVel` on page 1269

**8.12.2.3 How to enable the ALC**

1. Select "RF" > "RF Level" > "Automatic Level Control".
2. **NOTICE!** Risk of DUT damage due to high input power. The ALC modes "State" > "Off (Sample & Hold)" and "State" > "Sample & On" use a short sample pulse to set the level control. With the setting "Sample Level" > "Full", this sample pulse results in a CW RF pulse. Usually, the RMS value of this CW pulse equals the configured RMS level value of the signal, but it can also rise up to the PEP level.  
To protect the DUT from damage due to high input power, use the following setting combinations for the sampling states "Off (Sample & Hold)" or "Sample & On":
  - Set "Sample Level" > "Attenuated" or
  - Set "Sample Level" > "Minimum".
3. Set "RF" > "State" > "On".

**8.12.3 User correction**

The R&S SMW200A supports a correction function to compensate external losses, caused, for example, by the RF cable, to achieve a precise target input level at the DUT.

The signal at the RF outputs of the R&S SMW200A is flat. However, the DUT is usually not connected directly to the outputs of the instrument but rather via connecting cables. Components like cables, power combiners, switches or mixers can affect the signal flatness at the DUT input.

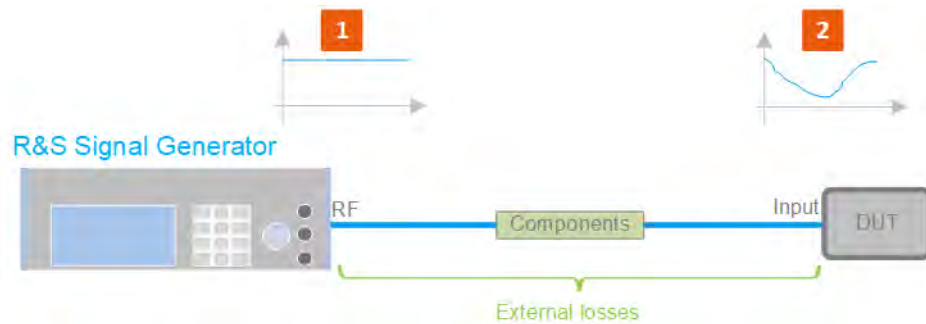

**Figure 8-20: Effect of external losses on the signal flatness at the DUT input**

- DUT = Device under test  
 Components = Designation of all components between the measurement equipment and the DUT, e.g. cables  
 1 = Flat signal at the outputs of the R&S SMW200A  
 2 = Signal received at the DUT, incl. the external losses

### About UCOR

User correction (UCOR) is a method that determines the external level loss of the RF output signal over a frequency range in advance, see [Figure 8-21](#).



User correction relates to the RF center frequency only. It does not affect the baseband bandwidth.

The difference between the generator output level and the level at the DUT determines the correction value at the respective frequency. Alternatively, the attenuation characteristics over a certain frequency range of, for example, RF cables are also specified in the associated specifications document.

For more information, refer to the specifications document.

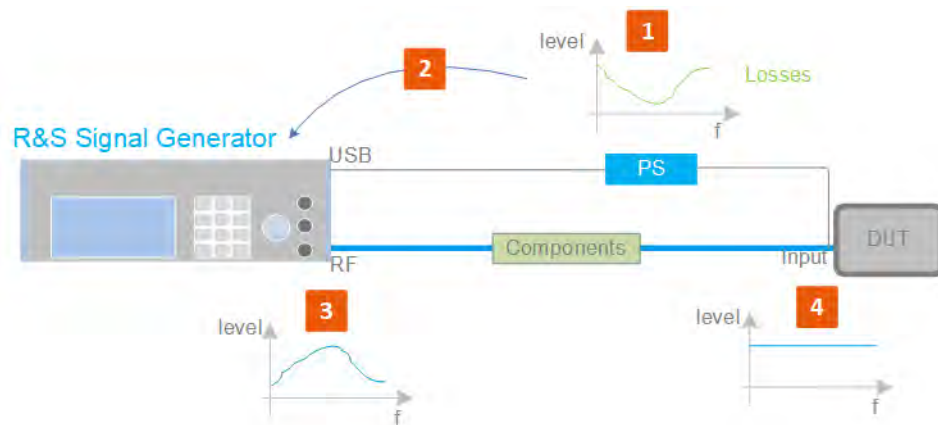

**Figure 8-21: Understanding the principle of user correction**

- DUT = Device under test  
 Components = Designation of all components between the measurement equipment and the DUT, e.g. cables  
 PS = Power sensor, e.g. R&S NRP, connected at the DUT's input and the USB connector of the R&S SMW200A
- 1 = Power sensor measures the level over a frequency range, where the collected values correspond to the losses caused by the components between the R&S SMW200A and the DUT
  - 2 = Obtain the correction data by inverting the collected data; load the correction parameters in the R&S SMW200A
  - 3 = In the R&S SMW200A, the RF signal is pre-processed with the correction values so that the signal at the outputs is the inverted version of the external losses
  - 4 = Received at the DUT input, the pre-processed signal is flat

With active **UCOR**, the generator adds the correction value internally and thus increases the output level by exactly the amount of the loss between its output and the DUT. For frequencies which are not contained in the list, the level correction is calculated by interpolation of the closest correction values.

### Possible ways for configuring the user correction values

You can configure correction values in the following ways:

- **Internally**

- Use the built-in table editor in the "UCOR > Edit User Correction Data" dialog. Once defined, user correction values can be saved in a file. Files with correction data can be exported, for example, to exchange configuration between instruments or to modify the file content with an external program and reload them again.
- Using the corresponding remote-control commands. Note that you have to create a user correction file first.

- **Externally**

Create a file with correction values as a CSV file with Microsoft Excel, with a Notepad or a similar tool and save it with the predefined extension. Transfer the file to and load it into the instrument.

### UCOR file format

Files containing correction data are simple files in text or comma-separated value (CSV) file format. The filename is user-definable; the file extension is \*.ucor.

The file contains a list of correction values, one row per frequency and correction value pair; a new line indicator separates the correction values.

For file handling, use the standard functions in the "File Manager", see [Section 11.8, "Using the file manager"](#), on page 719.

### Collecting correction data

To fill the frequency and power values in the correction table, use one of the following options:

- **Manually**, row by row.
- Fill the table **automatically** with linearly interpolated values, calculated from value range and step size.
- Acquire the real frequency response characteristics of the used component with the **R&S NRP power sensor**, see [Understanding the principle of user correction](#).

### Using a power sensor for frequency response measurements

Consider the following when using R&S NRP power sensors to measure the correction values:

- Measure the level directly at the input of the DUT.
- Use the internal correction functions of an R&S NRP power sensor to increase the measurement accuracy.
- Use S-parameter to consider the impact of any two-port device like an adapter between the signal generator and the sensor input.

For information on the various possibilities of interoperability between Rohde & Schwarz power sensors and Rohde & Schwarz signal generators, see the application note [1GP141](#).



### Interactions and characteristics

You can enable user correction in all operating modes.

However, user correction cannot be activated simultaneously with absolute level compensation based on user-defined frequency response values. These functions exclude each other; only one of them can be used at a time.

See the user manual "R&S SMW-K544 User-Defined Frequency Response Correction".

The RF output level ( $Level_{RF}$ ) is the sum of the level value and the correction for the particular frequency:

$$Level_{RF} = \text{"Status bar > Level"} + \text{"UCOR"}$$

If enabled, the R&S SMW200A indicates user correction by the "Lev Ucor" icon in the status bar.

### 8.12.3.1 User correction settings

Access:

1. Select "RF" > "RF Level" > "User Correction".
2. If you already have created a file with user correction data:
  - a) Select "UCOR Data" > navigate to the file "\*.uco" > "Select".
  - b) Proceed with [step 4](#).
3. If you need to create a file:
  - a) Select "UCOR Data" > "New".
  - b) Enter the filename `UCOR_Data` and confirm with "Ok".
  - c) Choose the file and confirm with "Select".
  - d) Select "Edit UCOR Data".
  - e) To fill the user correction data table, proceed as described in [Section 8.12.3.2, "Ucor data editor"](#), on page 593.
4. Select "UCOR" > "State" > "On".
5. Select block diagram > RF A > "On".

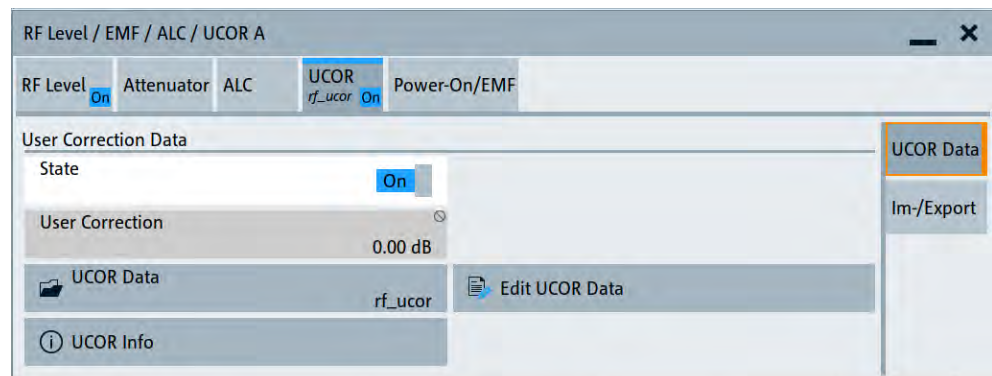

The "UCOR" dialog contains all settings for creating and handling files with user-defined level correction values.

The remote commands required to define these settings are described in [Section 14.19.6, "SOURCE:CORREction subsystem"](#), on page 1185.

#### Settings:

<a href="#">State</a> .....	592
<a href="#">User Correction</a> .....	593
<a href="#">UCOR Data</a> .....	593
<a href="#">Edit UCOR Data</a> .....	593
<a href="#">UCOR Info</a> .....	593

#### State

Enables user correction.



The R&S SMW200A displays the status icon "Lev Ucor" in the status bar.

You cannot enable both user correction and absolute level compensation based on user-defined frequency response values. These functions exclude each other.

See the user manual "R&S SMW-K544 User-Defined Frequency Response Correction".

Remote command:

[\[:SOURce<hw>\]:CORRection\[:STATe\]](#) on page 1190

### User Correction

Indicates the corrected level value for a specific frequency point.

Remote command:

[\[:SOURce<hw>\]:CORRection:VALue?](#) on page 1189

### UCOR Data

Accesses the standard "File Select" function of the instrument. The provided navigation possibilities in the dialog are self-explanatory.

Files with user correction values are files with predefined file extension \*.uco. When a file is selected, the dialog indicates the filename.

You can create the file internally in the table editor or externally.

- To select an existing file, select "Select List > navigate to the file \*.uco > Select"
- Use the general editor function to create a file or to edit an existing one.
- Use the standard file manager function to load externally created files to the instrument.

Remote command:

[\[:SOURce\]:CORRection:CSET:CATalog?](#) on page 1190

[\[:SOURce<hw>\]:CORRection:CSET\[:SElect\]](#) on page 1189

[\[:SOURce\]:CORRection:CSET:DELeTe](#) on page 1190

### Edit UCOR Data

Opens the build-in table editor to define a new correction table or edit an existing one.

See also:

- [Section 8.12.3.2, "Ucor data editor"](#), on page 593
- ["Fill..."](#) on page 543
- [Section 8.12.3.3, "Fill with sensor"](#), on page 596

### UCOR Info

Opens a window with information on the user correction file.

The window shows the metadata of the file and the output level parameters that are relevant for user correction.

Remote command:

n.a.

#### 8.12.3.2 Ucor data editor

The "User Correction" dialog provides a build-in list editor for defining the corresponding value pairs. Prerequisite to define correction values is that you have selected a file.

Access:

- ▶ "RF" > "RF Level" > "User Correction" > "Edit UCOR Data".

	Frequency (Hz)	Correction Value (dB)
0	1 560 000 000.00	11.51
1	1 561 000 000.00	11.03
2	1 562 000 000.00	10.55
3	1 563 000 000.00	10.07
4	1 564 000 000.00	9.59
5	1 565 000 000.00	9.11
6		

The editor for user correction data provides a table with RF frequency and level values and standard navigation functions. The remote commands required to define the user correction data are described in [Section 14.19.6, "SOURCE:CORRection subsystem"](#), on page 1185.



All columns in a row must contain values. Cells with missing values are therefore filled automatically, using the value of the previous row.

Once you enter a value, the editor automatically adds preset values in the other columns. This functionality protects against data loss, otherwise incomplete rows are lost when saving. You can simply override these values.

Since the table and navigation functions can be assumed to be known, the following description contains a brief overview.

**Settings:**

- Frequency (Hz)..... 594
- Correction Value (dB)..... 595
- User correction data handling keys..... 595
  - └ Select Row..... 595
  - └ Edit..... 595
  - └ Fill with Sensor..... 595
  - └ Save As/Save..... 595
- Fill..... 595

**Frequency (Hz)**

Sets the frequency for level correction.

Remote command:

[\[:SOURce<hw>\]:CORRection:CSET:DATA:FREQuency](#) on page 1188

### Correction Value (dB)

Sets the level correction value for the selected frequency.

Remote command:

[\[:SOURce<hw>\]:CORRection:CSET:DATA:POWer](#) on page 1188

### User correction data handling keys

Standard functions for handling user correction data and files.

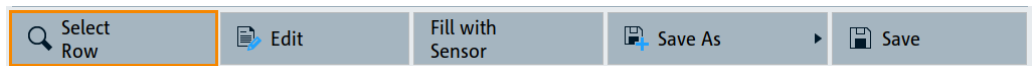

#### Select Row ← User correction data handling keys

Selects a row for editing.

#### Edit ← User correction data handling keys

Enables you to insert, or delete a row or ranges within the table, and provides access to a dialog for automatic filling, see "[Fill...](#)" on page 543.

#### Fill with Sensor ← User correction data handling keys

Opens a dialog to configure the automatic filling of user correction data with an R&S NRP power sensor.

See [Section 8.12.3.3, "Fill with sensor"](#), on page 596

#### Save As/Save ← User correction data handling keys

Saves the table in a file with user-defined name and predefined file extension. To save a copy or create a file, use the "Save as" function.

#### Fill...

Provides parameters for filling a table automatically with user-defined values.

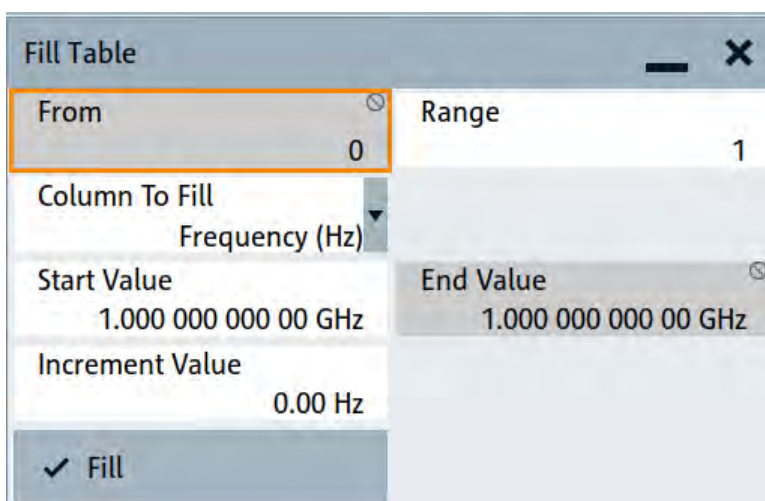

To fill the table, select "Fill".

**Note:** Once you enter a value or fill a column, the editor automatically adds preset values in the other columns. This functionality protects against data loss, otherwise incomplete rows will be lost when saving. You can simply override these values.

"From / Range"

Defines the start line and number of lines to be filled.

"Column To Fill"

Selects, if the column is filled up with frequencies in Hz, levels in dBm or dwell times in s.

"Start Value / End Value"

Sets the start value for frequency, level or dwell time. The end value is read only and depends on the increment value and the range.

"Increment Value"

Determines the step size.

"Fill"

Fills the column specified in "Column To fill".

### 8.12.3.3 Fill with sensor

The fill with sensor function requires that you have connected a power sensor and also selected a file for user correction data before.

See:

- [Section 8.12.4, "Using power sensors"](#), on page 600
- ["To create user correction data with an R&S NRP and the R&S SMW200A"](#) on page 618

Access:

1. Select "RF" > "RF Level" > "User Correction".
2. Select "User Cor. Data > navigate to the file \*.ucor > Select".
3. Select "Edit User Cor. Data > Fill With Sensor...".

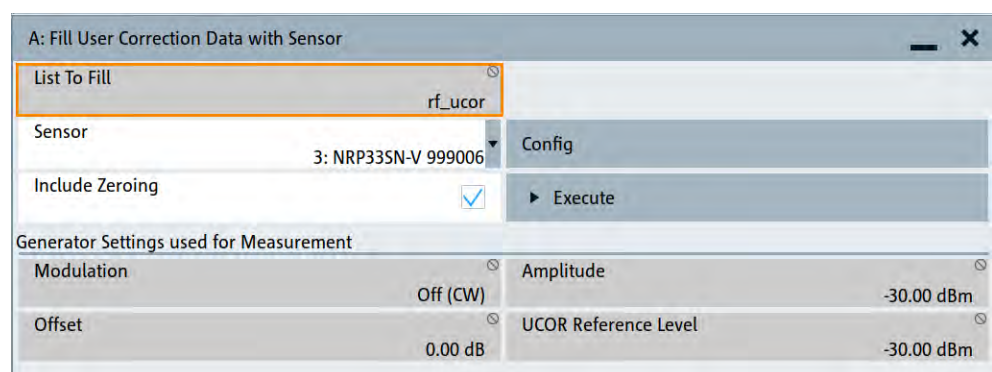

This dialog contains parameters for filling a table automatically with sensor readings.



To fill the table, select "Execute".

For information on power sensors and how to use them, see [Section 8.12.5, "Improving the RF signal performance"](#), on page 617.

### Settings:

<a href="#">Fill User Correction Data with Sensor</a> .....	597
<a href="#">Generator Settings used for Measurement</a> .....	597

### Fill User Correction Data with Sensor

The "Execute" button is only enabled if a sensor is detected and the user correction list contains at least one frequency value.

"Sensor"	Displays connected sensors for selection.
"List To Fill"	Indicates the used list.
"Config"	Opens the sensor configuration dialog to set the parameters for the selected power sensor.
"Include Zeroing"	<p>Performs a zeroing procedure before acquiring the user correction data to improve precision.</p> <p>No signal is applied to the sensor during zeroing. RF output is temporarily switched off during that time.</p> <p>When unchecked, the zeroing procedure is skipped. However, the RF signal level can be blanked shortly. This setting is useful if blanking of RF is undesirable or the absence of power at the sensor cannot be guaranteed.</p> <p>Remote command:  <a href="#">[:SOURce&lt;hw&gt;]:CORREction:ZERoing:STATe</a> on page 1189</p>
"Execute"	<p>Triggers the sensor to measure and to return the data for user correction.</p> <p>The "Execute" button is only enabled if a sensor is detected and the user correction list contains at least one frequency value.</p> <p>Remote command:  <a href="#">[:SOURce&lt;hw&gt;]:CORREction:CSET:DATA[:SENSor&lt;ch&gt;][:POWER]:SONCe</a> on page 1188</p>

### Generator Settings used for Measurement

Displays the settings relevant for the measurement.

"Modulation"	<p>Indicates that modulation is off.</p> <p>The R&amp;S SMW200A disables modulation for the "Fill with sensor" process, even if you have enabled a modulation and if you have started "Fill with sensor".</p>
"Amplitude"	<p>Displays the currently set level.</p> <p>Remote command:  <a href="#">[:SOURce&lt;hw&gt;]:POWER:POWER</a> on page 1273</p>

- "Offset" Displays the level offset, set with "Offset" on page 489.  
Remote command:  
`[ :SOURce<hw> ] :POWer[:LEVel] [:IMMediate] :OFFSet`  
on page 1278
- "UCOR Reference Level" Displays the reference value for user correction.  
The user correction reference level is the set [Amplitude](#) plus the set [Offset](#).  
Remote command:  
`[ :SOURce<hw> ] :POWer[:LEVel] [:IMMediate] :REFLevel`  
on page 1279

#### 8.12.3.4 Import/export list files

Access:

- Select one of the following:
  - "RF" > "Sweep / List" > "List mode".
  - "RF" > "RF Level" > "User Correction".
- Select "Import/Export".

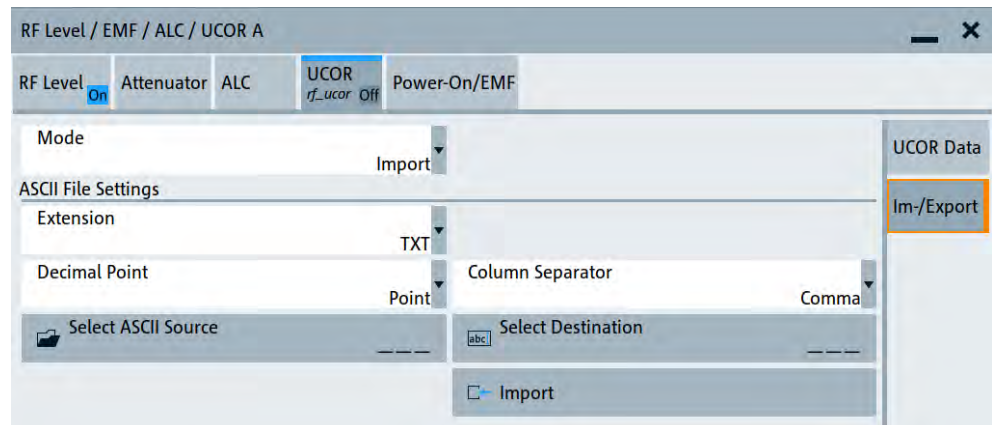

Figure 8-22: Im-/Export dialog (example with UCOR settings)

The "Import/Export" dialog contains all functions and settings to import externally created list data or to export it accordingly. You can process and store a list in the formats `*.txt` (ASCII), or `*.csv` (plain text with identical sequence of fields). The table separators and the decimal floating point numbers are customizable.

**Settings:**

Mode.....	599
ASCII File Settings.....	599
Select (ASCII) Source/Select (ASCII) Destination.....	599
Select Source/Select ASCII Destination.....	600
Import / Export.....	600

**Mode**

Selects import or export of a data list file. The provided parameters vary according to the selected mode.

Remote command:

`[ :SOURce<hw> ] :LIST:DEXChange:MODE` on page 1254

`[ :SOURce<hw> ] :CORRection:DEXChange:MODE` on page 1192

**ASCII File Settings**

Defines the format and the separators of the associated data file.

"Extension"      Selects \*.csv or \*.txt format.

"Decimal Point"      Sets "Point" (dot) or "Comma" as the decimal separator used in the ASCII data with floating-point numerals.

"Column Separator"      Sets the separator between the columns in an ASCII table.  
Available are: "Tab", "Semicolon", "Comma" or "Space".

Remote command:

`[ :SOURce<hw> ] :LIST:DEXChange:AFILe:EXTension` on page 1252

`[ :SOURce<hw> ] :LIST:DEXChange:AFILe:SEParator:DECimal` on page 1253

`[ :SOURce<hw> ] :LIST:DEXChange:AFILe:SEParator:COLumn` on page 1253

`[ :SOURce<hw> ] :CORRection:DEXChange:AFILe:EXTension` on page 1191

`[ :SOURce<hw> ] :CORRection:DEXChange:AFILe:SEParator:DECimal`  
on page 1192

`[ :SOURce<hw> ] :CORRection:DEXChange:AFILe:SEParator:COLumn`  
on page 1192

**Select (ASCII) Source/Select (ASCII) Destination**

In "Mode > Import", access the file select dialog that provides standard file handling functions.

Where:

- "Select ASCII Source": defines the file to be loaded (imported)
- "Select ASCII Destination": selects the filename under that the loaded file is saved

Remote command:

`[ :SOURce<hw> ] :LIST:DEXChange:AFILe:CATalog?` on page 1252

`[ :SOURce<hw> ] :LIST:DEXChange:AFILe:SElect` on page 1253

`[ :SOURce<hw> ] :CORRection:DEXChange:AFILe:CATalog?` on page 1191

`[ :SOURce<hw> ] :CORRection:DEXChange:AFILe:SElect` on page 1191

### Select Source/Select ASCII Destination

In "Mode > Export", access the file select dialog that provides standard file handling functions.

Where:

- "Select Source": selects the file to be exported
- "Select ASCII Destination": defines the filename and the file path for the exported file

Remote command:

[ :SOURce<hw> ] :LIST:DEXChange:SElect on page 1254

[ :SOURce<hw> ] :CORRection:DEXChange:SElect on page 1193

### Import / Export

Imports or exports the selected data list file, depending on the current mode.

Remote command:

[ :SOURce<hw> ] :LIST:DEXChange:EXECute on page 1253

[ :SOURce<hw> ] :CORRection:DEXChange:EXECute on page 1192

## 8.12.4 Using power sensors

The R&S SMW200A works with any of the R&S NRP power sensors and thus supports various application tasks. Using power sensors, you can for example determine attenuation characteristics of downstream equipment or cables. You can use the measured values to compensate the losses with internal control functions or with an external control circuit in real time.

For information on the various possibilities of interoperability between Rohde & Schwarz power sensors and Rohde & Schwarz signal generators, see the application note [1GP141](#).

R&S NRP power sensors are highly accurate standalone measuring devices, suitable for a wide range of applications. The power sensors communicate directly with the signal generator, calculate the average or peak power internally, include S-parameter correction and return the measurement results to the generator.

The R&S SMW200A supports up to four power sensors, allowing up to four power measurements simultaneously.



Check the firmware version of the R&S NRP sensors regularly. Update the firmware, if necessary.

For updates, see the Rohde & Schwarz website [www.rohde-schwarz.com](http://www.rohde-schwarz.com) in section "Power Meters & Voltmeters".

For more information on working with power sensors, see the following topics:

- [Section 8.12.4.1, "Connecting R&S NRP power sensors to the R&S SMW200A"](#), on page 601  
Overview on the supported connectors, connection options and the required accessories.
- [Section 8.12.4.2, "NRP power viewer"](#), on page 602



A function for measuring and monitoring the RF output power or a user-defined signal source.

- [Section 8.12.4.3, "NRP power control"](#), on page 605  
Controls a downstream closed loop power control circuit, to compensate frequency response characteristics.
- [Section 8.12.4.4, "NRP sensor configuration"](#), on page 610  
Parameter settings of the specific R&S NRP power sensor.
- [Section 8.12.4.5, "NRP sensor mapping"](#), on page 615  
Shows all R&S NRP sensors connected to the instrument, or in the LAN.

#### 8.12.4.1 Connecting R&S NRP power sensors to the R&S SMW200A

R&S NRP sensors are connected to the R&S SMW200A in the following ways:

- Connection to the SENSOR connector
  - R&S NRP-ZK6 (six-pole interface cable) for R&S NRPxx power sensors
  - No additional cable for R&S NRP-Zxx power sensors (cable is fixed on the sensor)
- Connection to the USB connector  
Requires the following cables, depending on the used sensor type:
  - R&S NRP-ZKU (USB interface cable) for R&S NRPxx power sensors
  - R&S NRP-Z3 or R&S NRP-Z4 (USB adapter cables) for sensors of the R&S NRP-Zxx family
- Connection via R&S NRP-Z5 sensor hub  
The R&S NRP-Z5 USB sensor hub (high-speed USB 2.0) can host up to 4 R&S NRP sensors.  
Requires additional cables, depending on the used output connector of the hub. Choose one of the following:
  - Short extension cable R&S NRP-Z2 for connection to the sensor connector. This six-pole connection provides the external trigger capability.
  - Standard USB cable (USB type A to USB type B) to any USB type A connector of the R&S SMW200A. This connection does not support external triggering.
- Connection via USB hub with external power supply unit  
Requires the following cables, depending on the used sensor type:
  - R&S NRP-ZKU (USB interface cable) for R&S NRPxx power sensors
  - R&S NRP-Z3 or R&S NRP-Z4 (USB adapter cables) for sensors of the R&S NRP-Zxx family
- Connection via LAN for R&S NRPxxxSN/xxxTN/xxxAN power sensors  
Using the Ethernet interface requires PoE (Power over Ethernet) to provide the electrical power.  
To establish the connection, you can use:
  - A PoE Ethernet switch, e.g. R&S NRP-ZAP1 and an RJ-45 Ethernet cable.
  - A PoE injector and an RJ-45 Ethernet cable.

For details, see the description R&S®NRP Power Sensors getting started.

### Detection and mapping

The R&S SMW200A either detects a R&S NRP power sensor automatically or you can scan for available power sensors manually. The "NRP Sensor Mapping" dialog lists all detected R&S NRP power sensors, see [Section 8.12.4.5, "NRP sensor mapping"](#), on page 615. The dialog enables you to add, remove and map the sensors manually.

Depending on the connection interface, the R&S SMW200A detects and maps connected R&S NRP power sensors differently:

- **SENSOR socket**  
Detects a sensor automatically and maps it with index "1" by default.  
If no sensor is connected to this socket, index "1" remains unassigned.
- **USB interface**  
Detects a sensor automatically and maps it with index "2" to index "4" according to the sequence of connection.
- **LAN interface**  
To detect sensors that are connected in the LAN, the instrument provides a scan function. When you start the function, scan searches in the LAN for available R&S NRP power sensors and adds all detected sensors to list. Assigning a mapping index activates the sensor for the measurement.



On connection, the R&S SMW200A immediately starts the measurement of the R&S NRP power sensor. If you preset the instrument ([PRESET] key or \*RST), the R&S SMW200A stops the measurement. The connection and the mapping of the power sensors remain.

#### 8.12.4.2 NRP power viewer

The R&S SMW200A features the power viewer function for measuring or monitoring signals with R&S NRP power sensors.

##### About

The R&S SMW200A can perform up to four power measurements simultaneously.

The measured signals can be the RF output power or other selected signal sources.

Depending on the signal characteristic (CW, AM, pulsed, etc.) or the parameter to be measured (average, peak, etc.) a suitable R&S power sensor must be used.

##### About the measuring principle, averaging filter, filter length, and achieving stable results

A sensor measures the average or peak RF power of the source continuously. The measurement results are displayed in the "NRP Power Viewer" dialog.

The power viewer function uses **averaging filters** for getting a stable readout.

Measurement results could be interfered, for instance, by too much noise in your setup, by a bad suppression of harmonics or non-harmonics or when you reach the sensitivity level of your power sensor.

Measurements are continuously repeated in a predefined time window. The measurement result is obtained by averaging the measured values for the last  $2N$  time windows. This approach is referred to as a **two-step averaging process**.

The factor of 2 in the formula arises because the output signals from the microwave detector are chopped at the same rate as the time windows to suppress low-frequency noise. An independent measured value can only be obtained from two consecutive values.

The variable  $N$  in the formula indicates the **filter length**. The filter length then directly influences the measurement time. The filter length can be selected automatically or it can be manually set to a fixed value.

Follow the following general recommendation to find out the **optimum filter length**:

- Always start a measurement in auto mode ("Filter > Auto").  
Check if the measurement results are sufficient.
- If the power is not constant, select the filter length manually ("Filter > User").  
Trigger the "Auto Once" function to search for the optimum filter length for the current measurement conditions.  
The estimated value is indicated as filter length.
- If the target measurement accuracy value is known, select "Filter > Fixed Noise".  
The averaging factor is selected automatically and so that the sensor's intrinsic noise (two standard deviations) does not exceed the specified noise content.
- Depending on the R&S NRP power sensor type, the manual setting of the filter length varies in resolution.
- Different sensor types achieve the same filtering result with different filter and time window lengths.  
For most sensors, the time window length is fixed to 20 ms, whereas, e.g., for the R&S NRP-Z81 sensor, the time window length is 10  $\mu$ s.

For more information, refer to the specifications document.

### About zeroing

Activates the auto zero function.

Zeroing calibrates the external power sensor by adjusting its reading at zero signal power. For this purpose, the RF power source must be switched off or disconnected from the sensor. If a Rohde & Schwarz power sensor receives an input power during the zeroing process, it aborts zeroing and generates an error message. Zeroing takes a few seconds, depending on the sensor model. Refer to the documentation of your power sensor for more information.

### Tips for zeroing

When to perform zeroing:

- During warm up after switching on or connecting the instrument
- After a substantial change of the ambient temperature
- After fastening the power sensor module to an RF connector at high temperature
- After several hours of operation

- When low-power signals are to be measured, e.g. less than 10 dB above the lower measurement limit.
- Switch off the RF power source for zeroing, but do not disconnect it from the power sensor. This proceeding keeps the thermal equilibrium, and the zeroing process also compensates the noise that superimposes the measured signal (e.g. from a broadband amplifier).

### Related settings and functions

- Measurements-related settings, like results, filter, filter length:  
[Section 8.12.4.4, "NRP sensor configuration"](#), on page 610
- Closed loop power control of the output level:  
[Section 8.12.4.3, "NRP power control"](#), on page 605.
- Software version of the connected power sensor:  
`:SENSe<ch>[:POWER]:TYPE?` on page 963
- Assignment of the external signals and the output connectors:  
[Section 12.2.4, "RF connectors settings"](#), on page 751
- Acquisition of level correction data:  
[Section 8.12.3, "User correction"](#), on page 588.

### Additional information

See the Rohde & Schwarz website [www.rohde-schwarz.com](http://www.rohde-schwarz.com), section "Power Meters & Voltmeters" for:

- R&S NRP power sensor manual.
- Information on the R&S NRP-Z5 sensor hub and the available accessories.
- Sensor software updates.

### NRP power viewer settings

Access:

- ▶ Select "RF" > "RF Measurement" > "NRP Power Viewer".

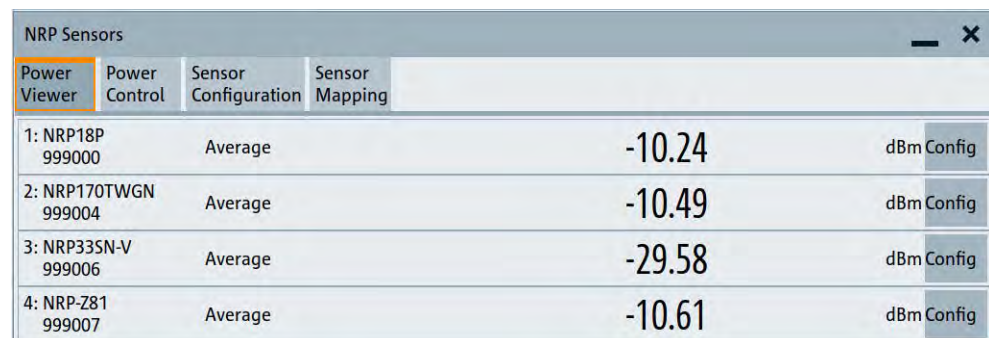

NRP Sensors			
Power Viewer	Power Control	Sensor Configuration	Sensor Mapping
1: NRP18P 999000	Average	-10.24	dBm Config
2: NRP170TWGN 999004	Average	-10.49	dBm Config
3: NRP335N-V 999006	Average	-29.58	dBm Config
4: NRP-Z81 999007	Average	-10.61	dBm Config

The "Power Viewer" tab lists the mapped R&S NRP power sensors with the measured parameter mode and the current readings. The "Config" button leads you to the configuration dialog to set the parameters for each sensor.

[Config](#).....605

### Config

Opens the "Sensor Configuration" dialog.

See also [Section 8.12.4.4, "NRP sensor configuration"](#), on page 610.

### 8.12.4.3 NRP power control

The NRP power control function enables you to apply stable and accurate RF power to the DUT. For example, you can set up a downstream closed loop power control circuit to compensate spurious effects or losses caused by power amplifiers or cables.

#### Example: How to set up a closed loop power control

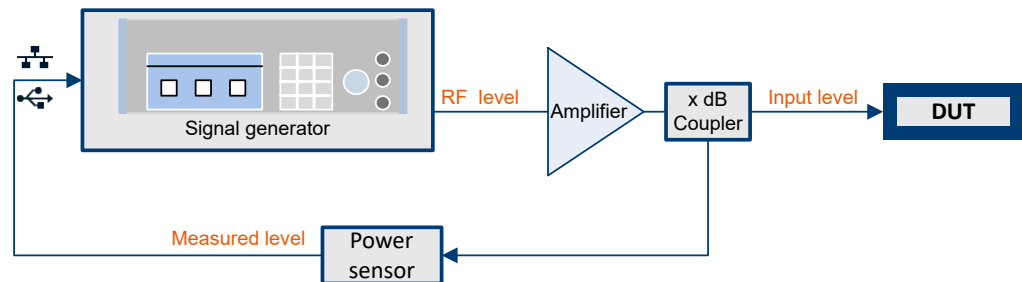

*Figure 8-23: Example of a test setup with NRP power control*

The signal generator applies the RF output signal to an amplifier and to the DUT. An intermediately connected coupler derives the output power from the output signal and forwards it to the power sensor. Thus, the power sensor measures a proportional power in defined time intervals, and returns the results to the signal generator. If supported, the power sensor also includes given S-parameters. The signal generator compares the measured power with the set level value and adjusts the level of the output signal accordingly.

This closed loop power control enables you to control the external signal level continuously and reliably achieve a constant input power at the DUT in real time.



### Impact of NRP power control and operating modes

Since the frequency and level of the RF output signal are continuously adjusted during "NRP Power Control", this operating mode interferes signal generation modes with varying frequency and level values. In addition, the setting time increases. The reason is the interaction between the signal generator and the R&S NRP power sensor in the control loop.

The operating modes impact each other as follows:

- Enabling the RF frequency sweep, RF level sweep or the list mode disables a running "NRP Power Control".
- A running list or RF sweep mode blocks "NRP Power Control".
- Modulated signals can deviate from the CW signal in mean power and peak power, and thus affect the "NRP Power Control".

### NRP power control settings

Access:

- ▶ Select "RF" > "RF Measurement" > "NRP Power Control".

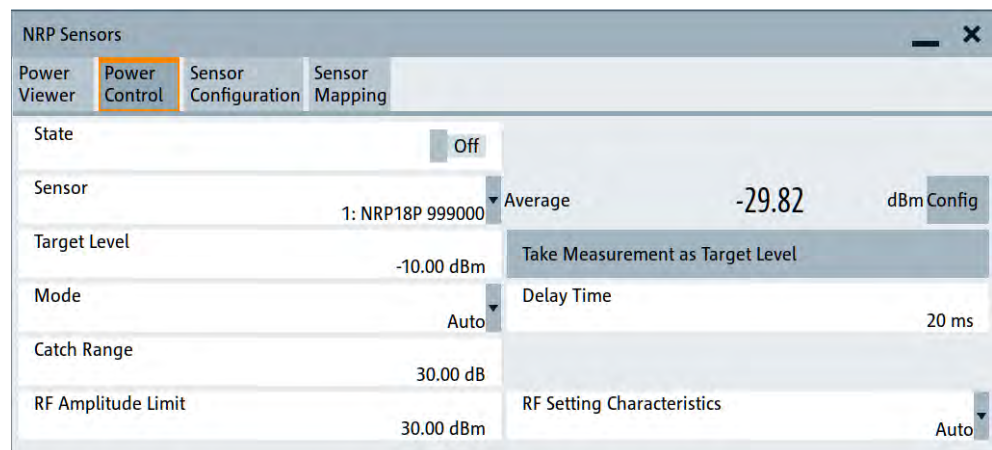

In this dialog you can configure the parameters of the power control setup for the selected power sensor.

The side tabs enable you to configure the settings for each path separately.

The remote commands required to define these settings are described in [Section 14.19.18, "SOURce:POWer subsystem"](#), on page 1264.

### Settings

State.....	607
Sensor.....	607
Measured Level.....	607
Target Level.....	607
Take Measurement as Target Level.....	607
Mode.....	607
Execute Single.....	608
Catch Range +/-.....	608

Delay Time.....	608
Limit.....	608
Setting Characteristics.....	608

**State**

Enables power control with the selected sensor.

The control loop periodically adjusts the generator output. After switching off, the running loop is completed.

**Note:** If you want to use another sensor, you must disable power control before. It is not possible to switch between sensors when power control is active.

Remote command:

`[ :SOURce<hw> ] :POWer:SPC:STATe` on page 1276

**Sensor**

Indicates the R&S NRP power sensor that is selected for power control.

To configure the power sensor parameters, see [Section 8.12.4.4, "NRP sensor configuration"](#), on page 610.

Remote command:

`[ :SOURce<hw> ] :POWer:SPC:SELEct` on page 1275

**Measured Level**

Indicates the current reading of the selected power sensor.

Remote command:

`:READ<ch> [ :POWer ] ?` on page 955

`:SENSe<ch>:UNIT [ :POWer ]` on page 956

**Target Level**

Specifies the nominal level expected at the input of the sensor. The signal generator adjusts the output power accordingly, to meet the target value at the sensor input, and thus the power required at the DUT.

Remote command:

`[ :SOURce<hw> ] :POWer:SPC:TARGet` on page 1276

**Take Measurement as Target Level**

Uses the currently measured level as reference and applies the value as target level, see ["Target Level"](#) on page 607.

This feature simplifies setting up the control loop after manual adjustment of the measurement configuration. To assign the measured level as reference level, you must switch off "NRP Power Control". It is not possible when the control loop is running.

Remote command:

`[ :SOURce<hw> ] :POWer:SPC:MEASure` on page 1275

**Mode**

Selects the measurement mode for acquiring the power values measured by the sensor.

"Auto"                      Immediately starts and measures the power continuously.

"Single" Starts when you manually select **Execute Single**, and executes one power measurement cycle.  
 Note, that you can achieve the expected target power level at the DUT only with linear test setups. Non-linear test setups, for example, setups including an amplifier do not work.

Remote command:

`[ :SOURce<hw> ] :POWer:SPC:MODE` on page 1275

### Execute Single

In mode "Single", starts one measurement cycle manually.

Remote command:

`[ :SOURce<hw> ] :POWer:SPC:SINGLE` on page 1276

### Catch Range +/-

Sets the capture range of the control system.

Within the range:

*Target Level +/- Catch Range*

the power control locks and tries to achieve the target level. Readings outside the range are not considered.

Remote command:

`[ :SOURce<hw> ] :POWer:SPC:CRANge` on page 1274

### Delay Time

Sets a waiting period between the level adjustment of the generator and the next measurement of the power sensor.

With this parameter, you can bypass idle times in the controlled system.

Remote command:

`[ :SOURce<hw> ] :POWer:SPC:DELAy` on page 1274

### Limit

Sets an upper limit for the output power.

**Note:** The parameter "RF level" > "**Limit**" and "NRP power control" > "**RF Amplitude Limit**" are identical.

You can use this value to protect your DUT from damage due to high input power. If you enter an RF level above this value, the instrument limits the output power to this specified value, and generates the warning message:

"Pep value greater than the defined limit." However, the level indication in the status bar is not affected.

The setting is not affected by an instrument preset ([PRESET] key or \*RST) and the "Save/Recall" function. It is reset only by factory preset.

Remote command:

`[ :SOURce<hw> ] :POWer:LIMit[:AMPLitude]` on page 1271

### Setting Characteristics

Selects additional quality characteristics to optimize the behavior of the RF signal level for the specific application.



"Auto"	<p>Sets the RF output level automatically according to the selected mode.</p> <p>In this mode, the instrument provides the highest dynamic range and fastest setting times.</p> <p>The RF signal is shortly blanked when the step attenuator is switching.</p> <p>For more information, refer to the specifications document.</p>
"Uninterrupted"	<p>Suppresses blanking at level transitions. Frequency transitions can lead to an RF level blanking due to hardware-specific switching points.</p> <p>This mode reduces the dynamic range of the instrument. The step attenuator is fixed.</p> <p><b>Note:</b> Do not enable both the I/Q optimization mode "High Quality" and the RF signal level optimization mode "Uninterrupted" or "Strictly Monotone". The high-quality I/Q optimization mode leads to an RF signal interruption which blocks the RF signal level optimization.</p>
"Strictly Monotone"	<p>Executes signal level changes monotonically increasing or decreasing.</p> <p>The setting makes sure that increasing the level value exclusively results in an increased output level, and vice versa.</p> <p>All electronic switches, which can affect the monotonicity are fixed.</p> <p>The operation mode is useful for applications using level searching algorithms which rely on a strictly monotonous behavior.</p>
"Constant-VSWR"	<p>Suppresses output impedance variations at the RF A/RF B output connector, due to changed level settings.</p>
"Continuous-Phase"	<p>Suppresses phase discontinuities.</p> <p>This mode reduces the dynamic range of the instrument and the step attenuator is fixed (equates to "Strictly Monotone").</p>
"Constant-Phase"	<p>This mode keeps the phase constant by coupling the digital attenuation directly to the level setting.</p> <p><b>Note:</b> The coupling is only active when the I/Q modulator is in operation.</p> <p>Pressing <a href="#">Readjust</a> adds the value of the digital attenuation to the level setting, and sets the <a href="#">Digital Attenuation = 0</a>. In total, the level value remains constant.</p>
"User"	<p>Selects this entry automatically when you change one of the following parameters from the default setting:</p> <ul style="list-style-type: none"> <li>• "Attenuator" &gt; <a href="#">Mode</a></li> <li>• "ALC" &gt; <a href="#">State</a>, <a href="#">Detector Sensitivity</a> or <a href="#">Driver Amplifier</a></li> </ul> <p><b>Note:</b> If you select another setting characteristic, the R&amp;S SMW200A presets the modified attenuator and ALC parameters.</p>

Remote command:

[ :SOURce<hw> ] :POWer:LBEHaviour on page 1271

#### 8.12.4.4 NRP sensor configuration

Access:

- ▶ Select "RF" > "RF Measurement" > "NRP Sensor Configuration".

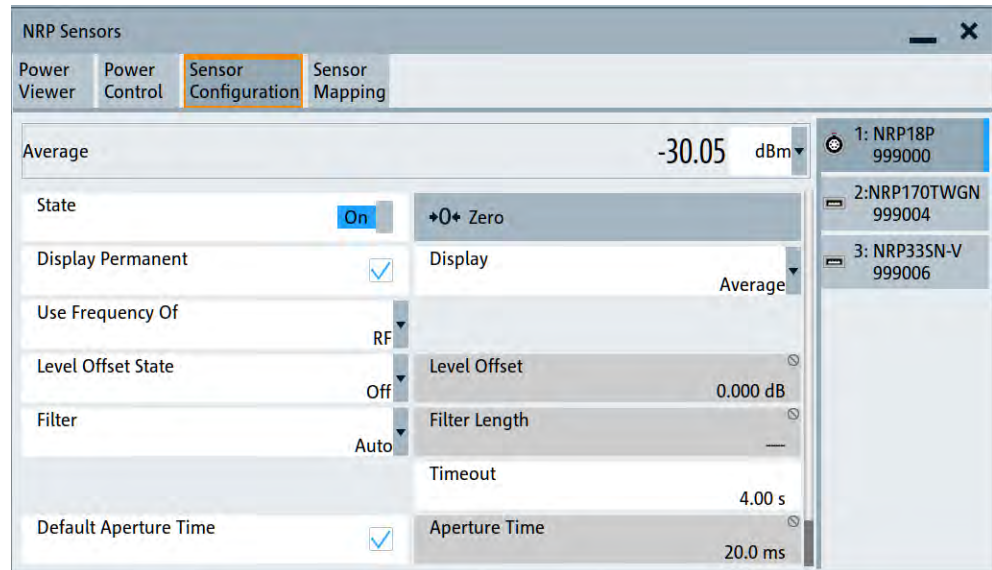

In this dialog you can configure the parameters for each mapped R&S NRP power sensor in separate tabs.

The remote commands required to define these settings are described in [Section 14.17, "SENSe, READ, INITiate and SLISt subsystems"](#), on page 948, including the triggering of the measurement and the retrieval of measurement results.

#### Settings:

Sensor type and serial number.....	611
Level (Peak) / Level (Average).....	611
State.....	611
Zero.....	611
Display.....	611
Display Permanent.....	611
Use Frequency Of.....	612
Frequency.....	612
Level Offset State, Level Offset.....	612
Filter.....	612
Filter Length.....	613
Auto Once.....	613
Noise/Signal Ratio.....	613
Timeout.....	613
Default Aperture Time.....	614

Aperture Time.....	614
S-Parameter.....	614
Enable Logging.....	614

### Sensor type and serial number

The side tab label indicates type and serial number of an R&S NRP power sensor and its mapping index.

The [Level \(Peak\)](#) / [Level \(Average\)](#) values display the current readings of the sensor.

Remote command:

[:SENSe<ch>\[:POWer\]:TYPE?](#) on page 963

[:SENSe<ch>\[:POWer\]:SNUMber?](#) on page 962

### Level (Peak) / Level (Average)

Indicates the measured peak or average level value.

You can also change the unit for the results display: Watt, dBm or dBμV.

**Note:** Peak level measurements are provided if the power sensor supports this feature.

Remote command:

[:READ<ch>\[:POWer\]?](#) on page 955

[:SENSe<ch>:UNIT\[:POWer\]](#) on page 956

### State

Enables level measurement of the R&S NRP power sensor.

Remote command:

[:INITiate<hw>\[:POWer\]:CONTinuous](#) on page 954

To query the availability of a sensor at a given connector, use the command [:SENSe<ch>\[:POWer\]:STATus\[:DEvIce\]?](#) on page 962.

### Zero

Activates the auto zeroing.

For details, see ["About zeroing"](#) on page 603.

Remote command:

[:SENSe<ch>\[:POWer\]:ZERO](#) on page 963

### Display

Sets the display of results on mean or peak power.

Remote command:

[:SENSe<ch>\[:POWer\]:DISPlay:PERManent:PRIority](#) on page 957

### Display Permanent

Enables the display of the power sensor with the currently measured value in the task bar.

The task bar label shows the measurement result, the channel, the sensor is mapped to and its serial number. Optionally, "(Offset,Peak)" appear when you have set these parameters.

You can activate the permanent display for several sensors.

Remote command:

[:SENSe<ch>\[:POWer\]:DISPlay:PERManent:STATe](#) on page 958

### Use Frequency Of

Selects the source for measurement.

"RF"	Assigns one of the RF signals of the R&S SMW200A. The R&S SMW200A transfers the RF frequency and level settings to the R&S power sensor automatically. Thus you achieve power readings of high accuracy, irrespective from the connected sensor type. You can also allocate two sensors in one path, for example to measure the power before and after the DUT.
"User"	Sets a user defined frequency.

#### Example:

If you have a frequency converting device between the generator and the DUT. If the frequency converter doubles the frequency, you can set twice the frequency in the R&S SMW200A. The R&S power sensor considers this RF frequency setting.

Set the parameter [Frequency](#) to the measurement's frequency.

Remote command:

[:SENSe<ch>\[:POWer\]:SOURce](#) on page 962

### Frequency

Defines the frequency value if "Source > User" is used.

Remote command:

[:SENSe<ch>\[:POWer\]:FREQuency](#) on page 960

### Level Offset State,Level Offset

Activates and defines a level offset which is considered in the power measurement result. The level offset value is always expressed in dB, irrespective of the display of the measurement result.

This function allows you to consider, for example, an attenuator in the signal path.

Remote command:

[:SENSe<ch>\[:POWer\]:OFFSet](#) on page 961

[:SENSe<ch>\[:POWer\]:OFFSet:STATe](#) on page 961

### Filter

Selects the way the length of the used filter is defined.

See also "[About the measuring principle, averaging filter, filter length, and achieving stable results](#)" on page 602.

"Auto"	<p>Selects the filter length automatically and adjusts it to the measured value. The value is indicated with the parameter <a href="#">Filter Length</a>.</p> <p>When high output power is applied, the filter length and therefore the measurement time can be short.</p> <p>When low output power is applied, the filter length and therefore the measurement time is increased which reduces the considered noise content in your measurement.</p>
"User"	<p>The filter length is defined manually, with the parameter <a href="#">Filter Length</a>.</p> <p>As the filter length works as a multiplier for the time window, constant filter length results in a constant measurement time.</p> <p>Values 1 and 2N are allowed.</p>
"Fixed Noise"	<p>The averaging factor is taken automatically in accordance to the value <a href="#">Noise/Signal Ratio</a>. Thus, the sensor's intrinsic noise (2 standard deviations) does not exceed the specified noise content.</p> <p>To avoid long measurement times when the power is too low, set a <a href="#">Timeout</a>.</p> <p>Timeout is the maximum acceptable measurement time which limits the averaging factor and therefore leads to a more unstable readout.</p>

Remote command:

[:SENSe<ch>\[:POWER\]:FILTer:TYPE](#) on page 960

### Filter Length

Sets or indicates the filter length, depending on the selected filter mode.

- "Filter > Auto" indicates the automatically adjusted filter length.
- "Filter > User" enables you to set the filter length manually.
- "Filter > Fixed Noise" hides the setting parameter.

Remote command:

[:SENSe<ch>\[:POWER\]:FILTer:LENGth:AUTO?](#) on page 958

[:SENSe<ch>\[:POWER\]:FILTer:LENGth\[:USER\]](#) on page 958

### Auto Once

Searches the optimum filter length for the current measurement conditions. The result is indicated with the parameter [Filter Length](#).

See also "[About the measuring principle, averaging filter, filter length, and achieving stable results](#)" on page 602.

Remote command:

[:SENSe<ch>\[:POWER\]:FILTer:SONCe](#) on page 959

### Noise/Signal Ratio

For [Filter > Fixed Noise](#), sets the noise content.

Remote command:

[:SENSe<ch>\[:POWER\]:FILTer:NSRatio](#) on page 959

### Timeout

Sets a time limit for the averaging process.

The setting is bound to the timeout of the connected sensor.

Remote command:

`:SENSe<ch>[:POWer]:FILTer:NSRatio:MTIME` on page 959

### Default Aperture Time

The sensor default setting is sufficient. Disable this parameter to specify a user-defined aperture time per sensor, if, for example, the readings vary.

To obtain stable readings, set the [Aperture Time](#) exactly to one modulation period.

Remote command:

`:SENSe<ch>[:POWer]:APERTure:DEFault:STATe` on page 956

### Aperture Time

If "Use Default Aperture Time > Off", defines the acquisition time per sensor.

For example, to obtain a sufficient low average value, set the aperture time exactly to one modulation period.

Remote command:

`:SENSe<ch>[:POWer]:APERture:TIME` on page 956

### S-Parameter

Activates the use of the S-Parameter correction data of the connected power sensor. For sensors with attenuator, this function is automatically activated.

S-Parameter correction is used to mathematically shift the reference plane to the DUT by considering the S-parameters for any components connected upstream of the sensor.

The S-Parameter table can be changed with the S-Parameters tool, provided as part of the free R&S NRP Toolkit software. For more information, refer to the manual of the connected R&S NRP power sensor.

Remote command:

`:SENSe<ch>[:POWer]:CORRection:SPDevice:STATe` on page 957

`:SENSe<ch>[:POWer]:CORRection:SPDevice:LIST?` on page 957

`:SENSe<ch>[:POWer]:CORRection:SPDevice:SElect` on page 957

### Enable Logging

Activates recording of R&S NRP power sensor readings in a log file.

There is 1 log file per sensor. The log files are created automatically and filled in continuously. They are text files with predefined filename `SensLog<n>.txt`, where `<n>` indicates the connected sensor. Log files are stored on the internal memory, in the directory `/var/user/SensorLogging`.

Each log file contains the measured value (2 readings when you work with peak sensors), the sensor type, and the measurement time (timestamp). Logged data is not overwritten. When a new measurement is started, the collected logging data is appended in the log file.

Check the used disc space regularly and remove log files to maintain storage capacity.

**Note:** The logging function is intended for measurements with long time intervals. It is suitable source for data reconstructions if the connection to the sensor was interrupted.

Remote command:

`:SENSe<ch>[:POWer]:LOGGing:STATe` on page 961

### 8.12.4.5 NRP sensor mapping

The "NRP Sensor Mapping" lists the sensors detected by the instrument.

Any R&S NRP sensor that supports the USB legacy protocol and is connected to one of the USB interfaces, is detected automatically and added to the list. When you disconnect a power sensor, the R&S SMW200A removes it from the list accordingly.

R&S NRP power sensors that are connected in the LAN or use the USBTMC protocol are only detected by the scan search function.

Access:

- ▶ Select "RF" > "RF Measurement" > "NRP Sensor Mapping".

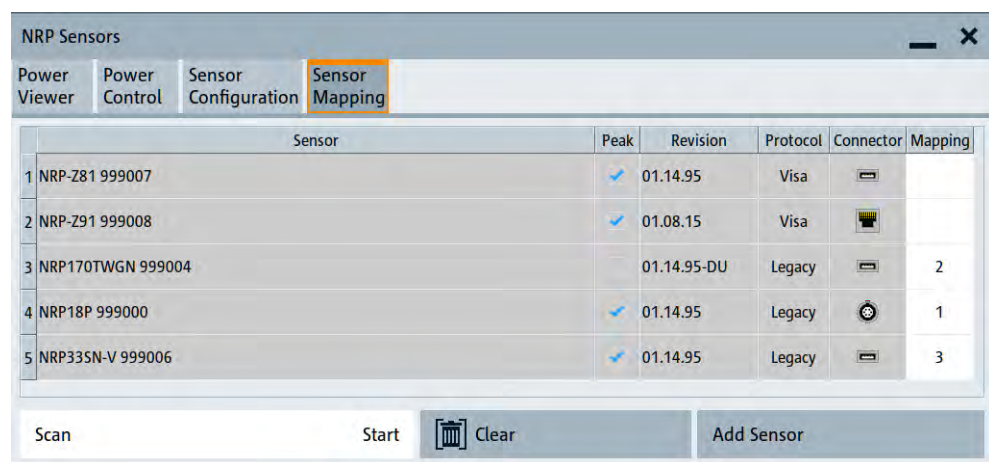

The dialog lists all detected R&S NRP sensors for selection and mapping. You can also browse the network for sensors.

The list informs on the sensor type with serial number, specific features and the revision of the sensor firmware.

For each sensor, you find the used protocol and the connector icon of the interface. In the "Mapping" column, you can assign a mapping index to enable the sensor for use. The list can contain several entries but the R&S SMW200A can only use up to four sensors simultaneously.

The remote commands required to define these settings are described in [Section 14.17, "SENSe, READ, INITiate and SLISt subsystems"](#), on page 948.

#### Settings

<a href="#">Sensor Mapping List</a> .....	615
<a href="#">Scan</a> .....	616
<a href="#">Clear</a> .....	616
<a href="#">Add Sensor</a> .....	616
<a href="#">Add LAN Sensor</a> .....	616
<a href="#">Add USBTMC Sensor</a> .....	617

#### Sensor Mapping List

Shows the sensors that are connected to the R&S SMW200A.

The table informs on the sensor type, specific features and the installed sensor firmware. It also shows the interface the sensor is connected to, including the communication protocol and the mapping index.

Remote command:

`:SLIST[:LIST]?` on page 952

`:SLIST:ELEMENT<ch>:MAPPING` on page 954

`:SLIST:SENSOR:MAP` on page 954

### Scan

Scans the network and the USB connections for sensors connected using the VISA communication protocol, i.e. sensors that are addressed over LAN or USBTMC.

The instrument detects sensors communicating over the USB legacy protocol automatically.

Remote command:

`:SLIST:SCAN[:STATE]` on page 952

### Clear

Removes the selected sensor from the sensor mapping list.

Remote command:

`:SLIST:CLEAR:LAN` on page 953

`:SLIST:CLEAR:USB` on page 953

`:SLIST:CLEAR[:ALL]` on page 954

### Add Sensor

Shows or hides the "Add Sensor" dialog to configure power sensors connected to the R&S SMW200A over USB or LAN.

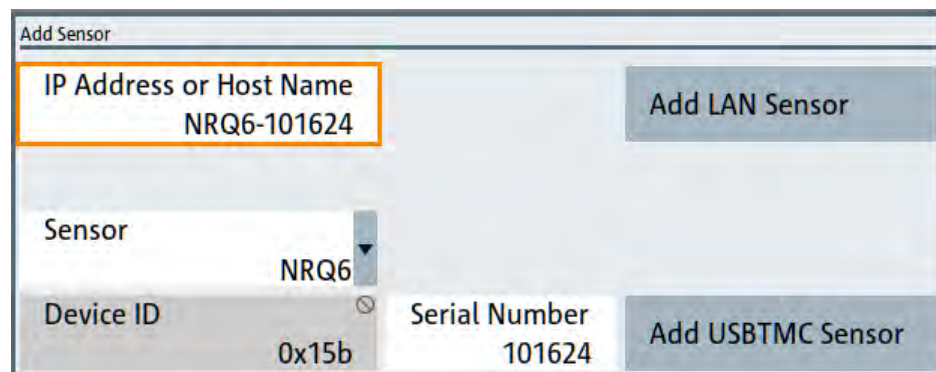

### Add LAN Sensor

Configures settings to add sensors connected to the R&S SMW200A over LAN.

"IP Address or Host Name"

Displays the host name or the IP address of a R&S NRP power sensor.

If the R&S SMW200A does not detect a connected R&S NRP sensor, you can assign the address information manually.



**"Add LAN Sensor"**

Adds a detected R&S NRP sensor connected in the LAN to the list of sensors, including its device ID or name and its serial number.

Remote command:

:SLIST:SCAN:LENSor on page 952

**Add USBTMC Sensor**

Configures settings to add sensors connected to the R&S SMW200A over USB.

If the R&S SMW200A does not detect a connected R&S NRP sensor, you can assign the device ID manually.

**"Sensor"**

Selects the name of the R&S NRP power sensor.  
If the R&S SMW200A does not contain the R&S NRP power sensor you use, select "<from Device ID". The "Device ID" entry field switches in edit mode where you can enter the ID of your product manually.

**"Device ID"**

Displays the device identifier of a selected R&S NRP power sensor.  
If you want to assign the device ID manually, get the information in the user documentation of your power sensor.

**"Serial Number"**

Displays the serial number of the R&S NRP power sensor.  
If the R&S SMW200A does not detect a connected R&S NRP sensor, you can assign the serial number manually.

**"Add USBTMC Sensor"**

Adds a detected R&S NRP sensor connected at the USB interface to the list of sensors, including its device ID or name and its serial number.

Remote command:

:SLIST:SCAN:USENSor on page 953

## 8.12.5 Improving the RF signal performance

To achieve an accurate input level at the DUT, you can compensate losses, e.g. caused by cables between the RF output and the DUT over a frequency range.

Using the user correction function and e.g., a R&S NRP power sensor, the R&S SMW200A utilizes the readings of the power sensor and creates a correction value table for controlling the output level during operation.

**To connect the R&S NRP to the R&S SMW200A**

1. Connect the power sensor.  
See [Section 8.12.4.1, "Connecting R&S NRP power sensors to the R&S SMW200A"](#), on page 601.
2. Select "RF" > "RF Measurement" > "NRP Sensor Mapping".

- If the sensor is not detected automatically, select "Scan > Start".  
The instrument scans the network and the USB connections for connected sensors and lists all detected R&S NRP sensors in the mapping table.
- In the "Mapping" column, assign the sensor to a sensor channel, see [Section 8.12.4.5, "NRP sensor mapping"](#), on page 615.
- Close the dialog.

### To configure and calibrate the R&S NRP in the R&S SMW200A

Provided the power sensor is connected to the R&S SMW200A and is assigned to a sensor channel, we recommend that you calibrate and configure the power sensor.

- In the block diagram > RF A, turn off the RF output signal.
- Select "RF" > "RF Measurement" > "NRP Power Viewer".

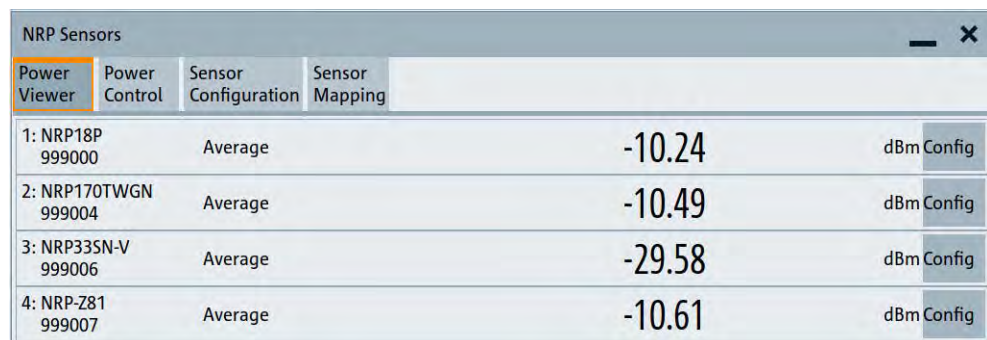

NRP Sensors			
Power Viewer	Power Control	Sensor Configuration	Sensor Mapping
1: NRP18P 999000	Average	-10.24	dBm Config
2: NRP170TWGN 999004	Average	-10.49	dBm Config
3: NRP335N-V 999006	Average	-29.58	dBm Config
4: NRP-Z81 999007	Average	-10.61	dBm Config

- To configure a sensor, select "Config".
- Select "Zero" to start zeroing of the sensor.  
**Note:** Always turn the RF power off or disconnect the sensor from RF before zeroing, since the function calibrates the power sensor at zero signal power.  
The zeroing process takes a few seconds, depending on the power sensor type.
- Configure additional parameters for the selected sensor as required.
- Select "State > On".
- Close the dialog.

### To create user correction data with an R&S NRP and the R&S SMW200A

We assume, that the power sensor is connected, assigned and ready for operation.

- Select "RF" > "RF Level" > "User Correction".

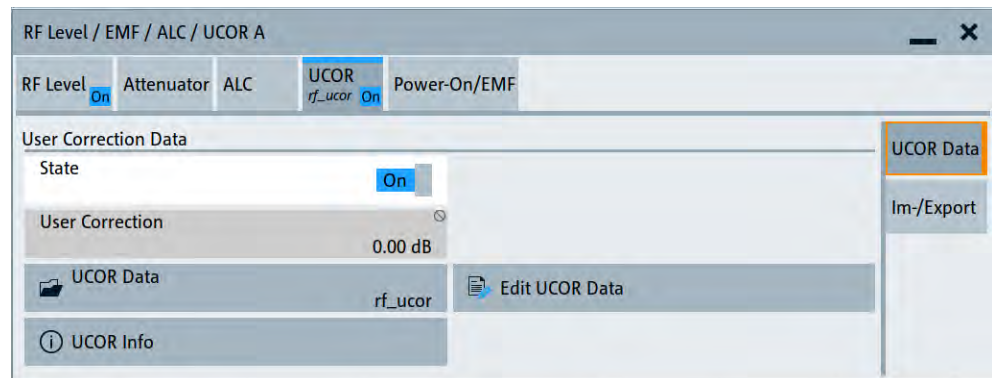

2. Select "UCOR Data" > "UCOR Data...."
3. Create a file: "New" > Filename and confirm with "OK".
4. Select the new file with "Select".
5. Select "Edit UCOR Data...".
6. Select "Edit" > "Fill".  
The "Fill Table" dialog enables you to fill in the values of the columns automatically.
7. To fill in the frequency column:

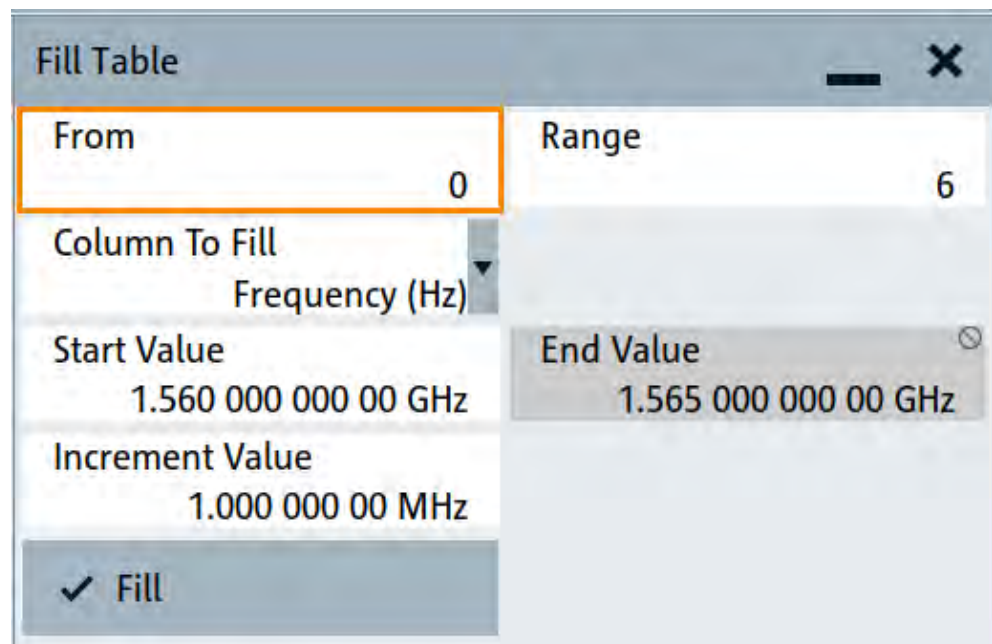

- a) Select "Select Column To Fill > Frequency / Hz".
- b) Select "Range > e.g. 15" to determine the number of values.
- c) Select "Start Value > e.g. 1.56 GHz".
- d) Select "Increment Value > e.g. 1 MHz", to determine the frequency steps.
- e) Select "Fill", to insert the frequency values.

The "Fill" function also fills the column of the "Correction Value / dB" values with a predefined value, since empty cells lead to the data loss of the entire line. If you need different values, you can change them manually, or you can use the automatic function "Fill with Sensor" as described in the next steps.

8. Select "Fill with Sensor".

The "Fill User Correction Data With Sensor" dialog provides an overview of the sensor configuration.

9. Select "Execute".

The R&S SMW200A successively sets each frequency point, reads the measured power of the sensor and fills in the value in the correction table.

	Frequency (Hz)	Correction Value (dB)
0	1 560 000 000.00	11.51
1	1 561 000 000.00	11.03
2	1 562 000 000.00	10.55
3	1 563 000 000.00	10.07
4	1 564 000 000.00	9.59
5	1 565 000 000.00	9.11
6		

10. Select "Save" to save the data in the file.
11. Close the dialog.

### To calibrate the power level with user correction data

We assume that a user correction file is available in the user directory of the R&S SMW200A or on a memory stick or in a shared directory.

If you have created and saved the file immediately before this step, the file is loaded in the "User Correction" dialog automatically. Otherwise you can load a previously saved file.

1. Select "RF" > "RF Level" > "User Correction".
2. Select "UCOR Data" > "UCOR Data...", if there is no file loaded already.
3. Select the directory and file you want to use.
4. Load the file with "Select".
5. To view the file content, select "Edit UCOR Data...".

6. Select "UCOR Data" > "State" > "On" to apply the user correction values.

When you activate the RF output, the R&S SMW200A considers the user correction data and adjusts the signal level accordingly to compensate external frequency responses.

## 9 Monitoring signal characteristics

The R&S SMW200A is a highly configurable signal generator with versatile routing possibilities and level settings distributed over several dialogs. You can optimize the signal generation process and monitor signal parameters during signal routing through the instrument. For these purposes, the R&S SMW200A offers a real-time graphical signal display and a power level surveillance function.

This section explains the provided functions for monitoring of the signal characteristics in real time. Here you can find out how to visualize the generated signal with measurement diagrams and how to enable measurements on the baseband power levels.

### 9.1 Monitoring baseband signal characteristics

Instead of analyzing the baseband signal characteristics with an external instrument, the R&S SMW200A can also visualize a subset of these signal characteristics with the built-in graphical signal display function. Also, this function evaluates signal measurement quantities and displays signal characteristics graphically in real-time.

#### 9.1.1 Required options

The minimum equipment layout for using this function includes

- Option standard baseband or wideband baseband generator (R&S SMW-B10/-B9) per signal path
- Option baseband main module, one/two I/Q paths to RF (R&S SMW-B13/-B13T) or Option wideband baseband main module two I/Q paths to RF (R&S SMW-B13XT)

#### 9.1.2 About the graphical signal display

To ease the setting and routing of baseband signals, R&S SMW200A is able to capture these signals and display them graphically in different ways: as I/Q, vector, eye or constellation diagram, as power spectrum or as statistical evaluations.

In the digital domain, the measurements are based on recorded I/Q samples. The sources of these samples are selectable points (acquisition points) in the signal flow. You can configure and display the signal characteristics simultaneously in up to diagrams.

##### 9.1.2.1 Available diagrams

This section focuses on graphical signal displays, their content and application. See [Table 9-1](#) for an overview of the signal characteristics that you can monitor.

Table 9-1: Graphics modes overview

Graphics modes	Domain	Measurement instrument
I/Q diagram	Time	Oscilloscope (standard mode)
Vector diagram	Time	Oscilloscope (XY mode)
Constellation diagram	Time	Oscilloscope (XY mode)
Eye diagram	Time	Oscilloscope (triggered to symbol clock and showing repetitive traces)
CCDF display	Statistical representation of peaks	Peak power analyzer
Power spectrum	Frequency	Spectrum analyzer

### I/Q diagram

The I/Q diagram displays the in-phase component ( $i[t]$ ) and quadrature component ( $q[t]$ ) of the I/Q signal over time.

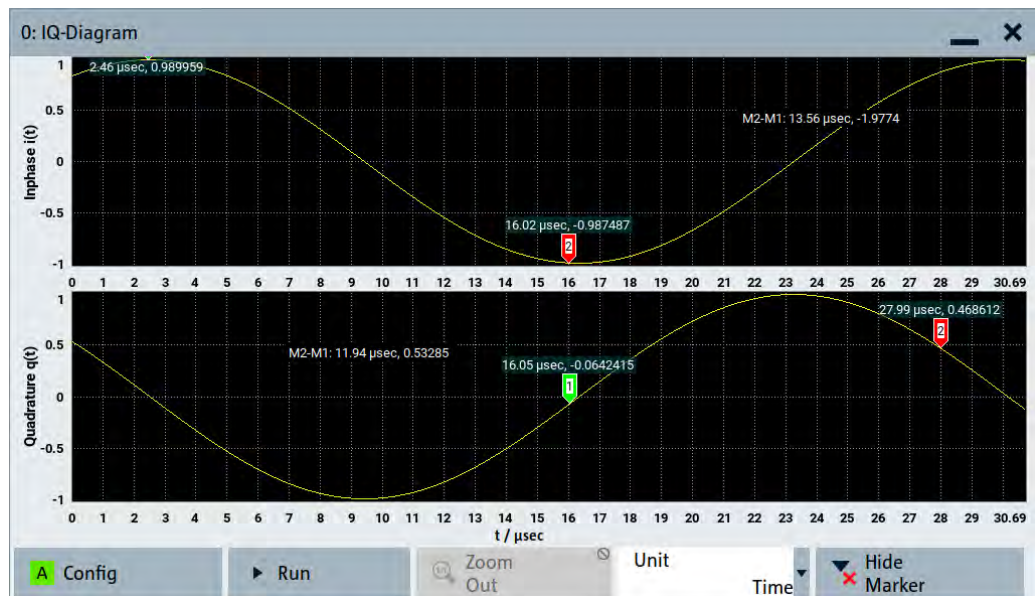

Figure 9-1: I/Q diagram with markers

= window with two separate coordinate systems with identical x-axis and y-axis  
 x-axis = time in units number of symbols, chips, samples or seconds depending on the signal  
 y-axis = amplitude, scaled to the peak envelope power; where minimum scaled amplitude = -1, maximum scaled amplitude = +1

**Application:** To analyze impairments, fading, added noise and added signals (e.g. from external baseband input) or from second path in the time domain. This mode shows the signal like an oscilloscope.

**Signal acquisition points:** See [Table 9-2](#).

### Vector diagram

The vector diagram displays the Q component over the I component. All points in the complex domain are connected by lines.

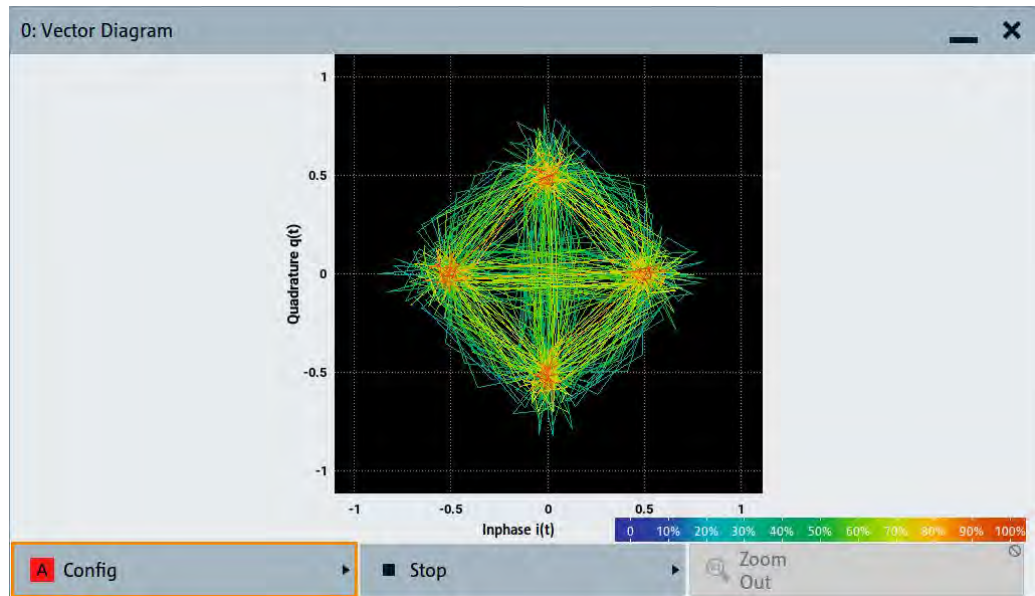

**Figure 9-2: Vector diagram (QPSK 45° offset)**

x-axis = In phase component  $I(t)$  of the signal is scaled to the peak envelope power, range -1 to 1  
 y-axis = Quadrature phase component  $Q(t)$  of the signal scaled to the peak envelope power, range -1 to 1

**Application:** To analyze the transition between the various states of modulation mapping, especially with linear modulations like MSK, QPSK or QAM. This mode shows the signal like an oscilloscope (X/Y-mode).

**Signal acquisition points:** See [Table 9-2](#).

### Constellation diagram

Constellation diagrams display the modulation symbols as discrete points in the I/Q plane. Unlike the vector diagram, the constellation diagram displays only one sample per symbol. This sample represents the symbol.

Constellation diagrams are helpful when generating signals using the "Custom Digital Modulation" settings. Compare the displayed constellation diagram with the diagram displayed in the "Modulation" tab of the "Custom Digital Modulation" dialog.



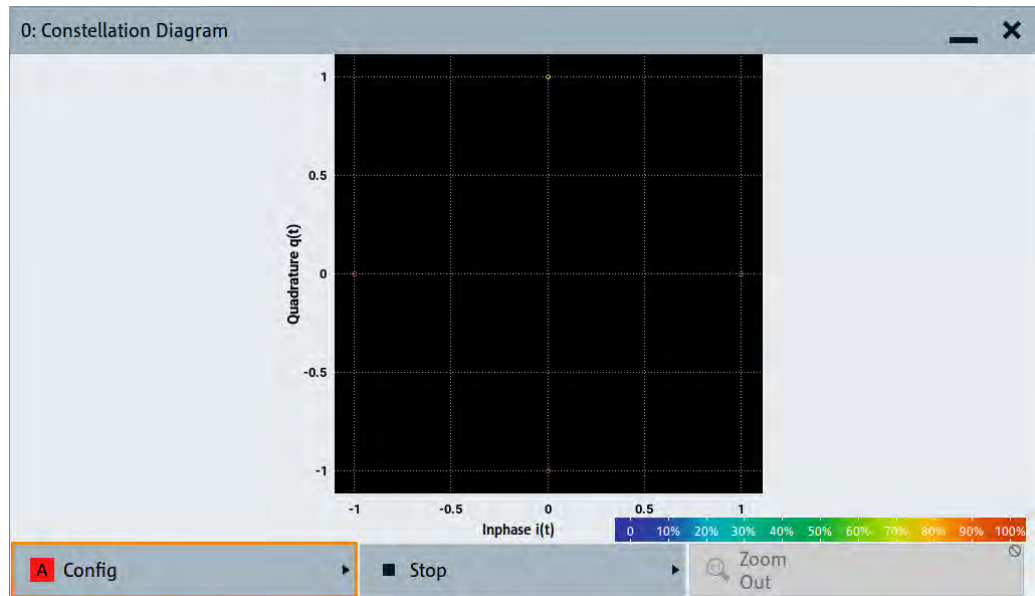

**Figure 9-3: Constellation diagram (QPSK 45° offset)**

x-axis = In phase component  $I(t)$  of the signal is scaled to the peak envelope power, range -1 to 1  
 y-axis = Quadrature phase component  $Q(t)$  of the signal scaled to the peak envelope power, range -1 to 1

**Application:** To classify modulation.

**Signal acquisition points:** See [Table 9-2](#).

### Eye diagram

The eye diagram displays synchronized and superimposed sections of either the in-phase or the quadrature components of the signal.

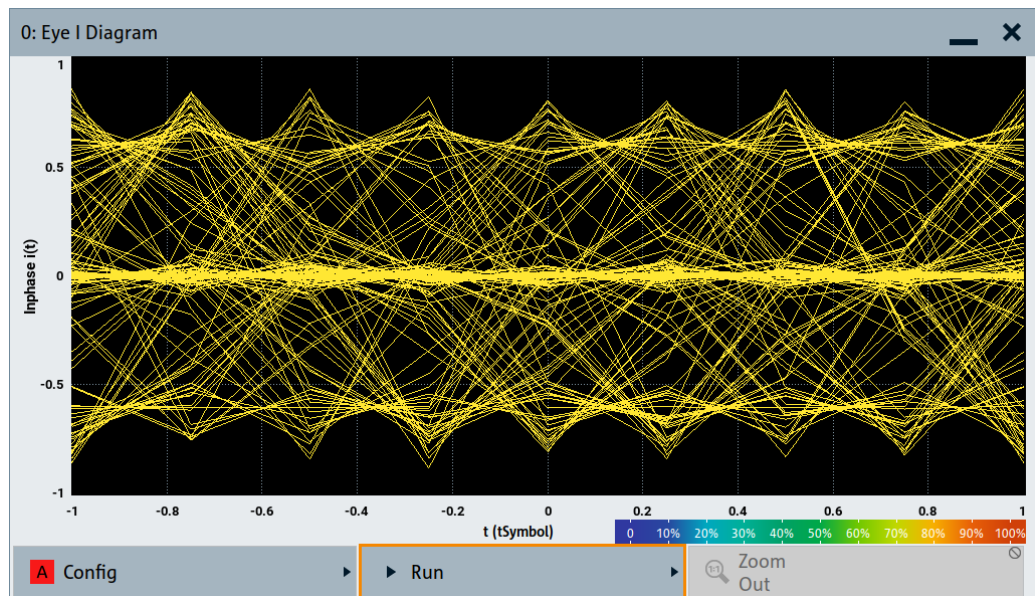

**Figure 9-4: Eye diagram with partially closed eye (QPSK 45° offset)**

x-axis = time in the range of  $\pm 1$  symbol

y-axis = amplitude, scaled to the peak envelope power; where minimum scaled amplitude = -1, maximum scaled amplitude = +1

The display width is normalized for 2 symbols. It uses one-symbol eye opening in the center of the display and 1/2-symbols to the left and right of the center eye for capturing time transitions. Several hundred curve segments are superimposed. The beginning of the recording is synchronous to the symbol and chip clock pulse.

**Application:** To analyze amplitude and time distortion elements (e.g. jitter) at high-speed digital data systems. A high quality, unimpaired signal shows a clearly open eye (horizontally and vertically).

**Signal acquisition points:** See [Table 9-2](#).

### CCDF display

The complementary cumulative distribution function (CCDF) displays the probability with which the output signal exceeds the average power.

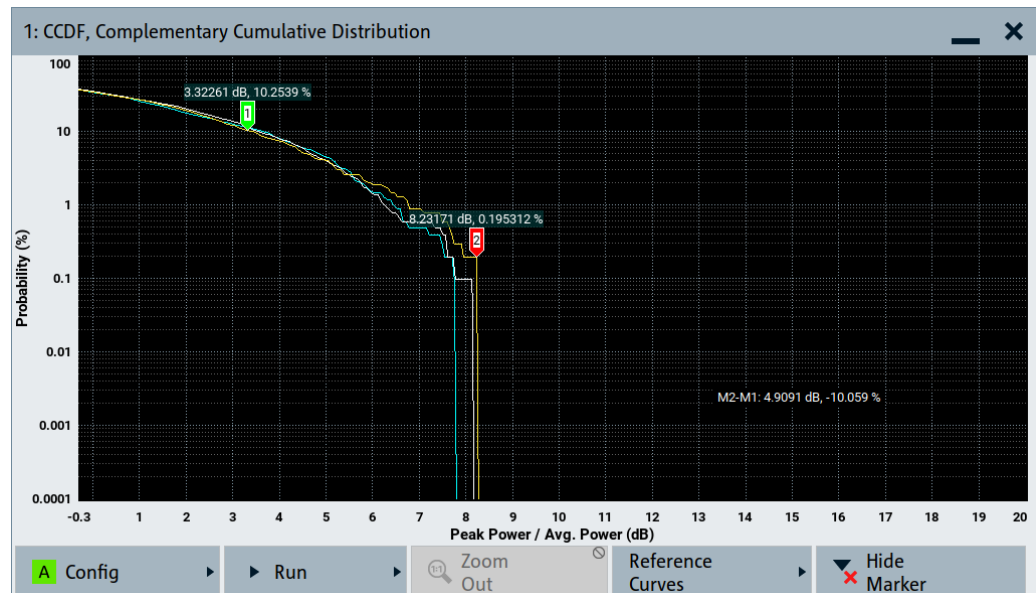

**Figure 9-5: CCDF diagram of a 5 MHz LTE signal (Level -30 dBm) and two reference curves**

x-axis = Level over the average signal power, where the average power (RMS) corresponds to the origin  
 y-axis = Probability of exceeding the average power that is the percentage of time the signal spends at or above the power level specified by the X-axis

Marker 1 = Interpolation: About 10.3 % of the samples exceed 3.3 dB above average; 1% of the samples exceed 7.5 dB above average (not shown with a marker)

Marker 2 = The point where the trace crosses the x-axis; indicates the highest peak that is found in the sample block and is 9.6 dB higher than average.

The CCDF diagram is calculated over 8 ksample and corresponds to a signal with the following characteristics:

- "Baseband" > "LTE" and "Test Model" > "E-TM1\_1\_\_5 MHz"
- In the status bar, set "Level" = "-30 dBm" and "PEP" = "-18.43 dBm"

The difference between the level and the PEP results in the peak to average ratio. If the measurement is long enough, the displayed highest peak corresponds to the calculated crest factor.

The PEP value does not indicate how often the peak level is reached. The CCDF shows the probability for reaching a dedicated instantaneous power.

**Signal acquisition points:** See [Table 9-2](#).

### Power spectrum

The power spectrum displays the signal spectrum which is calculated from the I/Q signal with fast Fourier transform (FFT). The power density over frequency is displayed.

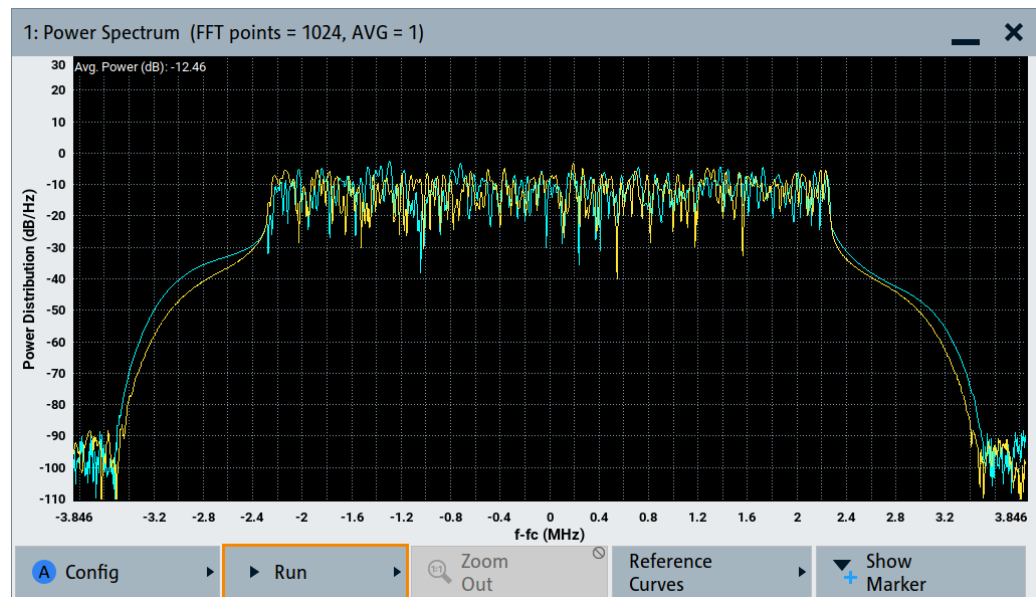

**Figure 9-6: Power spectrum diagram of a 5 MHz LTE signal with enabled reference curve (blue)**

"FFT points" = indicates the number of I/Q value pairs that are used for calculating a (part-)FFT

"AVG" = indicates the number of subspectra used for averaging

x-axis = frequency plotted symmetrically (- Sampling Rate/2 to +Sampling Rate/2)

y-axis = power density

**Signal acquisition points:** See [Table 9-2](#).

#### 9.1.2.2 Signal acquisition points

Signal characteristics can be displayed using different methods and different acquisition points, also at the same time. [Table 9-2](#) shows which signal acquisition point is suitable for which kind of graphics mode. Also, it provides associated graphics sources and the designation of the access points in the block diagram.

**Table 9-2: Signal acquisition points, modes and sources**

Signal acquisition points	Graphics modes	Graphics source	Designation
Baseband signals	Constellation diagram, eye diagram	"Baseband" "BB Input"	A or B A or B
Input streams	I/Q diagram, vector diagram, CCDF diagram, power spectrum diagram	"Stream"	A or B
Analog outputs	I/Q diagram, vector diagram, CCDF diagram, power spectrum diagram	"IQ Out" "RF"	1 or 2 A or B
Digital output streams	I/Q diagram, vector diagram, CCDF diagram, power spectrum diagram	"BBMM"	1 or 2

Figure 9-7 shows an example for locations of signal acquisition points.

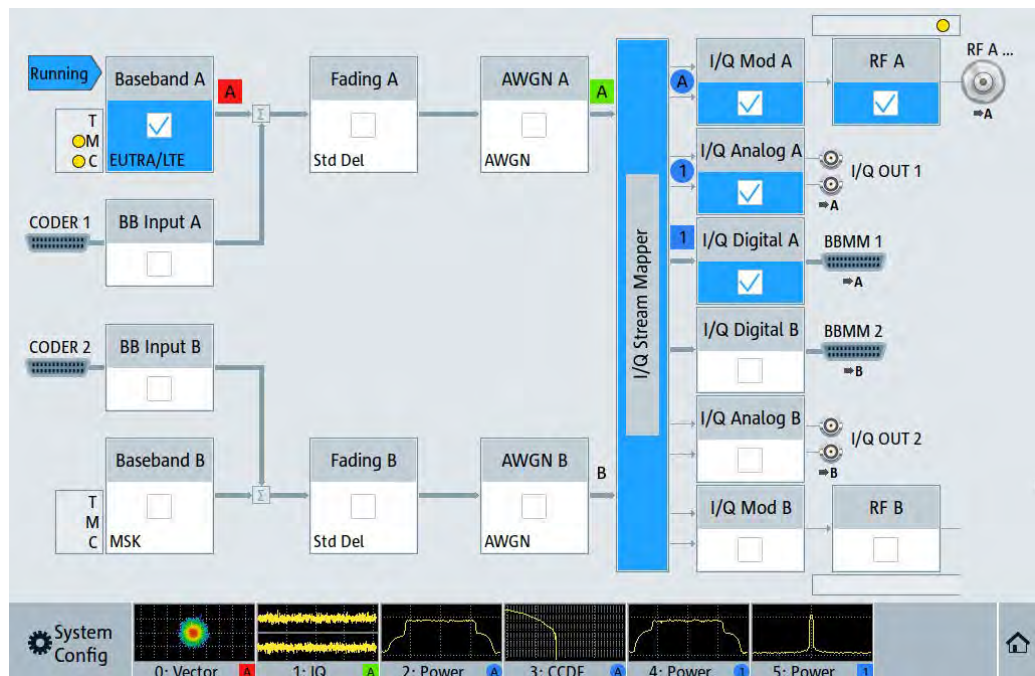
**Figure 9-7: Block diagram with graphical signal display and signal acquisition points**

The available signal acquisition points depend on the selected configuration (signal routing), see [Section 4, "Signal routing and system configuration"](#), on page 100.

### 9.1.2.3 Display functions

The graphical display provides general display functions known from other measurement instruments and offers zoom and markers.

### Zooming

You can zoom into the diagram to visualize the measurement results in greater detail. Using the touchscreen or a mouse pointer you can easily define the area to be enlarged.

Zooming is merely a visual tool, it does not change the number of samples used for the calculation. You can increase the number of samples before zooming.



See also ["To zoom into a diagram"](#) on page 641.

### Using markers

Markers are tools for numerical readout of measured data in diagrams. They help you analyze the displayed signal characteristics by determining particular values in the diagram.

Often you can use markers to measure the frequency distance of two peaks or to measure the power decrease of an oscillator at a given frequency offset, dBc value. Note that markers in the diagram are not related to the markers in the digital standards.

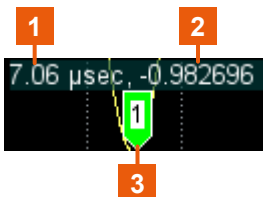
In the graphical display, the markers and their values (for example time or frequency) are displayed as usual.

Single marker indication	Delta marker indication
 <ul style="list-style-type: none"> <li>1 = marker position on the x-axis in the current units</li> <li>2 = marker value on the y-axis</li> <li>3 = marker number</li> </ul>	 <ul style="list-style-type: none"> <li>1 = delta marker</li> <li>2 = result of the marker function, i.e. the delta values in the current units</li> </ul>

See also ["To enable markers to read-out measured data"](#) on page 642.

### Persistence and color maps

In addition to the standard representation, the vector, the constellation, and the power spectrum diagrams use a color map.

The color encodes the relative amplitude (in percent) of the probability distribution of the data points in the diagram. A detailed breakdown of the colors is below diagrams the colors are relevant for. Data points in areas with high probability are marked in red, data points in areas with low probability in blue. Thus, for example, you can observe not only the "level versus frequency" trace but also a third dimension, the probability of the power level.

### Reference trace

Reference traces help you analyze a displayed characteristic, as do the markers. Reference traces are used to define amplitude curves or spectral distribution boundaries in

the result diagram which are not to be exceeded. They indicate, for example, the upper power limits which are allowed from a device under test (DUT).

The R&S SMW200A supports up to five reference traces. You can load reference traces and activate them simultaneously.

### 9.1.3 Graphics configuration settings

This section focuses on the graphics configuration dialog, which determines the number and kind of the graphical signal displays.



Access:

1. Select the sine wave icon.

The "Graphics Configuration" dialog opens.

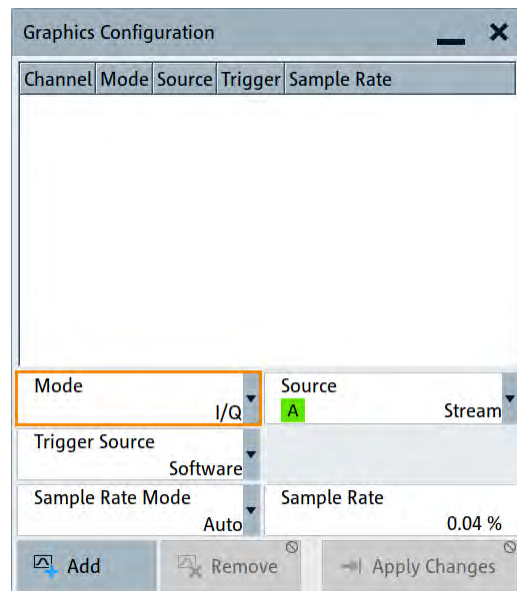

**Figure 9-8: Graphics configuration dialog**

2. To display a certain characteristic of the signal, use the parameter "Mode".
3. To select suitable signal acquisition points, use the parameter "Source".
4. To enable the graphical signal display, select "Add".

A thumbnail of the graphical signal display is shown in the taskbar.

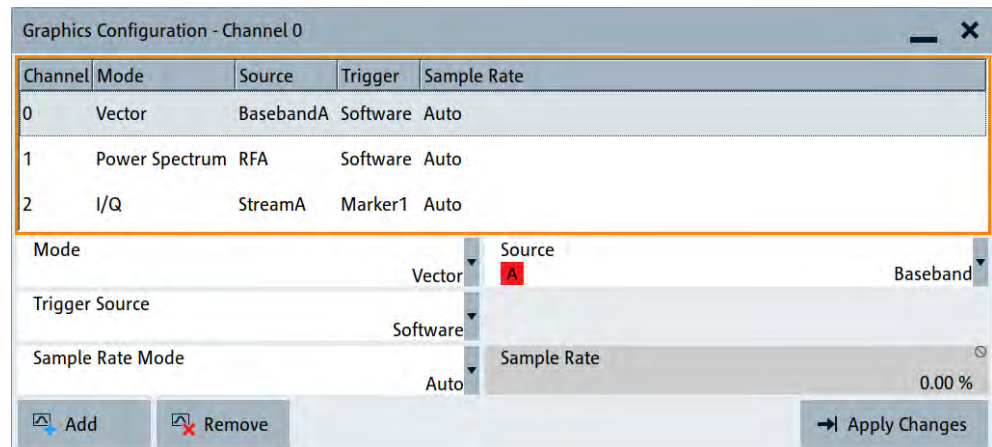

Figure 9-9: Graphics configuration dialog with active graphical signal displays

- To enlarge the thumbnail, select it.

#### Settings:

Graphical Diagrams Table.....	631
Mode.....	631
Source.....	631
Mux Stream.....	632
FFT Length.....	632
Full Scale (dBFS).....	632
Trigger Source.....	632
Sample Rate Mode.....	632
Sample Rate.....	633
Add.....	633
Apply Changes.....	633
Remove.....	633

#### Graphical Diagrams Table

The active graphical signal displays are listed in the table at the top of the dialog.

#### Mode

Sets the graphics mode, see [Section 9.1, "Monitoring baseband signal characteristics"](#), on page 622.

Remote command:

`[ :SOURce<hw> ] :BB:GRAPhics:MODE` on page 1174

#### Source

Sets the source for the signal acquisition point.

See [Section 9.1.2.2, "Signal acquisition points"](#), on page 627.

You cannot monitor external digital baseband signals from the [FADER] connectors.

Remote command:

`[ :SOURce ] :BB:GRAPhics:SOURce` on page 1176

**Mux Stream**

Requires mode "System Configuration" > "Fading/Baseband Config" > "Signal Outputs" > "Digital Only Multiplexed".

Selects which of the multiplexed streams is monitored and displayed.

Remote command:

[\[:SOURce\]:BB:GRAPhics:SOURce:MUX](#) on page 1176

**FFT Length**

Requires "Mode" > "Power Spectrum".

Selects the number of samples to be included in the graph of the power spectrum.

Remote command:

[\[:SOURce\]:BB:GRAPhics:FFTLen](#) on page 1177

**Full Scale (dBFS)**

Requires "Mode" > "Power Spectrum".

Sets the normalization of the power values in the diagram. Observe the change in the units on the y-axis.

"On"                    The maximal digital power  $|I|=|Q|=\max$  is mapped to 0 dB in the power spectrum diagram.

The y-axis shows the normalized power in dBFS.

"Off"                    The frequency average of the displayed power (frequency domain) agrees with the average power in the time domain.

The y-axis shows the power distribution in dB/Hz.

Remote command:

[\[:SOURce\]:BB:GRAPhics:FFTFscale](#) on page 1177

**Trigger Source**

Sets the trigger source for signal recording.

"Software"            Recording of signals starts automatically in predefined intervals. This asynchronous method is suitable if a representative display of the complete signal is required.

"Marker 1"            The starting point for recording of signals is determined by the marker 1 setting of the activated digital standard ("Trigger/Marker" dialog). This synchronous method is suitable if specific signal segments are to be shown in greater detail. With periodic signals, a static image is obtained by selecting a period length of marker 1 that is equal to the signal period.

The displayed signal segment can be shifted by entering a marker delay in the "Trigger/Marker" dialog of the activated digital standard.

Remote command:

[\[:SOURce<hw>\]:BB:GRAPhics:TRIGger:SOURce](#) on page 1177

**Sample Rate Mode**

Sets how the time resolution of the signal is determined. Maximum resolution corresponds to a display covering the entire signal bandwidth. The higher the resolution, the shorter the length of the displayed signal segment.



"Auto"	The resolution is set to an optimum value in terms of signal and display type.
"Full Bandwidth"	The resolution is set so that the display covers the entire signal bandwidth.
"User"	Activates the "Sample Rate" input field, where you can manually set the resolution.

Remote command:

[\[:SOURCE<hw>\]:BB:GRAPHics:SRATe:MODE](#) on page 1175

### Sample Rate

Displays the sample rate and depend on the sample rate mode as follows:

- If "Sample Rate Mode" = "Auto" or "Full Bandwidth", the sample rate displays the percentage of the entire signal bandwidth which is used for the graphical signal display.
- If "Sample Rate Mode" = "User", the sample equals the input for the percentage of signal bandwidth which is used for the graphical signal display.

Remote command:

[\[:SOURCE<hw>\]:BB:GRAPHics:SRATe:USER](#) on page 1175

### Add

Adds a graphical signal display to the taskbar and graphical diagrams table.

Remote command:

[\[:SOURCE\]:BB:GRAPHics:ADD](#) on page 1176

### Apply Changes

Enables the current settings for the selected graphical signal display.

### Remove

Removes the selected graphical signal display from the taskbar/graphical diagrams table.

Remote command:

[\[:SOURCE\]:BB:GRAPHics:CLOSe](#) on page 1175.

The command closes all graphical signal displays.

## 9.1.4 Graphical signal display settings

Access:

1. In the taskbar, select "System Config" > "Graphics" > "Add".
2. Double-click the thumbnail in the taskbar.

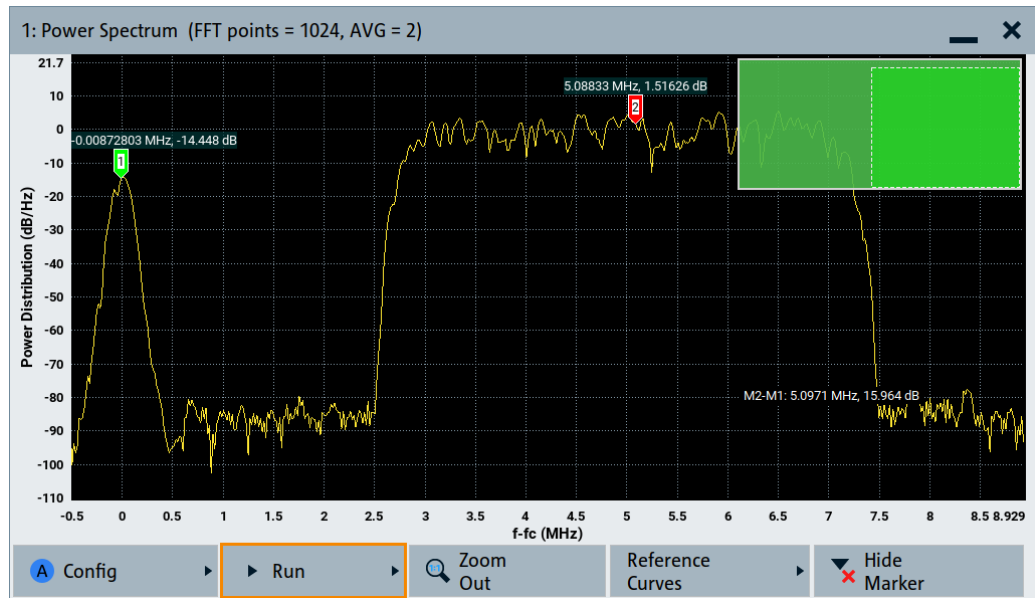

Figure 9-10: Graphical signal display of a power spectrum with markers

This section focuses on the functions of the enlarged graphical signal displays.

### Settings:

Configure.....	634
Stop/Run.....	634
Zoom Out.....	634
Reference Curves.....	634
Display Units.....	635
Show Marker/Hide Marker.....	635
Reference Curves.....	635

### Configure

Opens the "Graphics Configuration" dialog, see [Section 9.1.3, "Graphics configuration settings"](#), on page 630.

**Note:** This function is available for enlarged graphical signal displays and in the context menus of the thumbnails.

### Stop/Run

Stops the processing of the displayed signal and freezes it.

"Run" continues a stopped displayed signal.

### Zoom Out

Resets a previous zoom, see also ["To zoom into a diagram"](#) on page 641.

### Reference Curves

Opens the dialog for defining reference curves, see ["Reference Curves"](#) on page 635.

**Display Units**

Changes the units of the X-axis. The available values depend on the generated signal.

**Show Marker/Hide Marker**

Shows two markers on the curve of the displayed signal or hides them.

See also:

- ["Using markers"](#) on page 629
- ["To enable markers to read-out measured data"](#) on page 642

**Reference Curves**

Enable the indication of up to five configurable reference curves (traces).

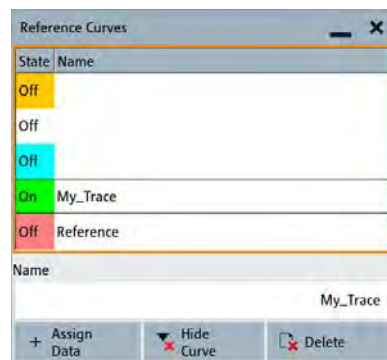

See ["Reference trace"](#) on page 629.

**Reference curves table**

Lists the configured reference curves and their current state.  
To change a curve, select it.

"Name"	Enters the name of a new reference curve.
"Assign Data"	Opens the standard "File Select" function to load a file describing a reference curve.
"Show Curve"	Shows or hides the selected curve.
"Delete"	Removes the curve.

**9.1.5 Checking the generated signal graphically**

This section shows you how to use the different graphic modes to visualize the signal characteristics of the generated signal. It also shows how to observe the effect of standard settings, like an applied filter, an enabled fading or AWGN. The examples use a simple custom digital modulated signal.

**To generate a simple WCDMA-3GPP (QPSK 45° offset) signal**

- Use the custom digital modulation. Enable a predefined WCDMA-3GPP signal.

For more information, see [Section 3.3.2, "Generating a digitally modulated signal"](#), on page 56.

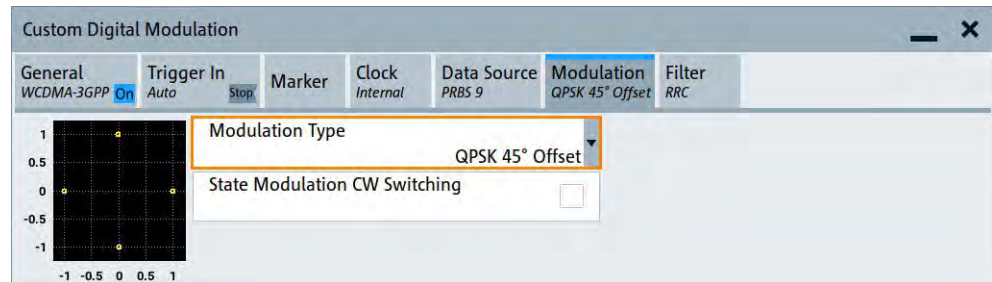

Figure 9-11: Used modulation type

### Configure the graphical signal display

1. In the taskbar, select the graphics icon:



The "Graphics Configuration" dialog opens.

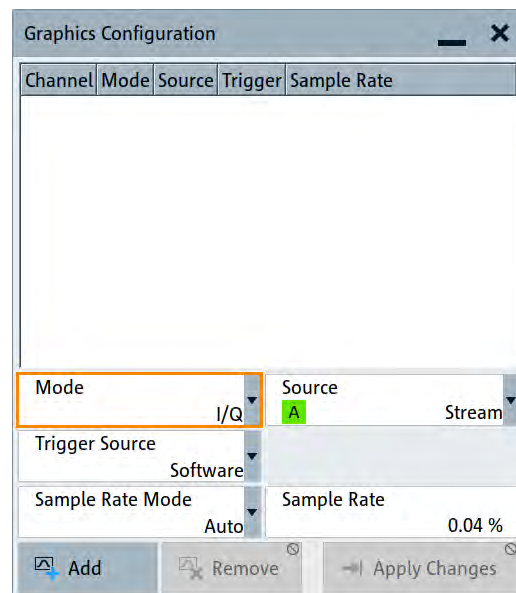

2. Select "Mode" > "Constellation".
3. Select "Source" > "Baseband".
4. To view the signal, select "Add".

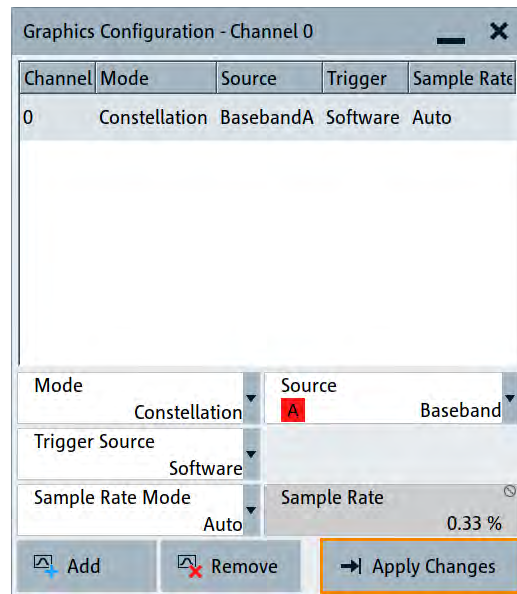

A new thumbnail (minimized view) indicating the constellation diagram appears in the taskbar.

- To enlarge the constellation diagram, select it.

The displayed constellation diagram confirms the QPSK offset modulation.

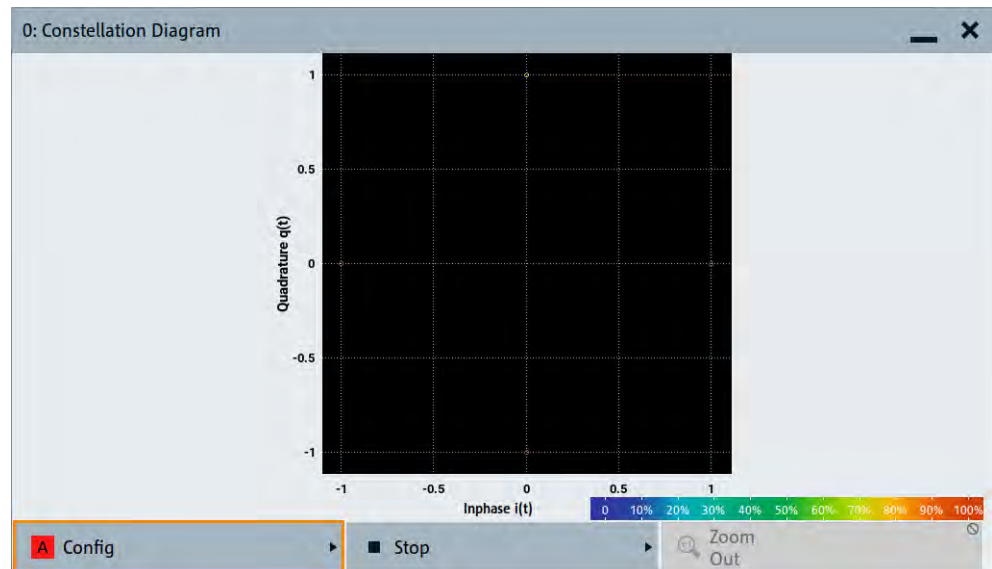

Figure 9-12: Constellation diagram of a WCDMA-3GPP (QPSK 45° offset) signal

### To set and verify a baseband frequency offset

- Select "Baseband" > "Baseband Offsets".
- In the "Baseband Offsets" dialog, set "Baseband" > "Frequency Offset" = "1 Hz".
- In the "Constellation Diagram", select "Configure".

The "Graphics Configuration" dialog opens.

4. Add a vector diagram with signal acquisition point "Stream"
5. Enlarge the vector diagram.

The vector diagram rotates with 1 Hz.

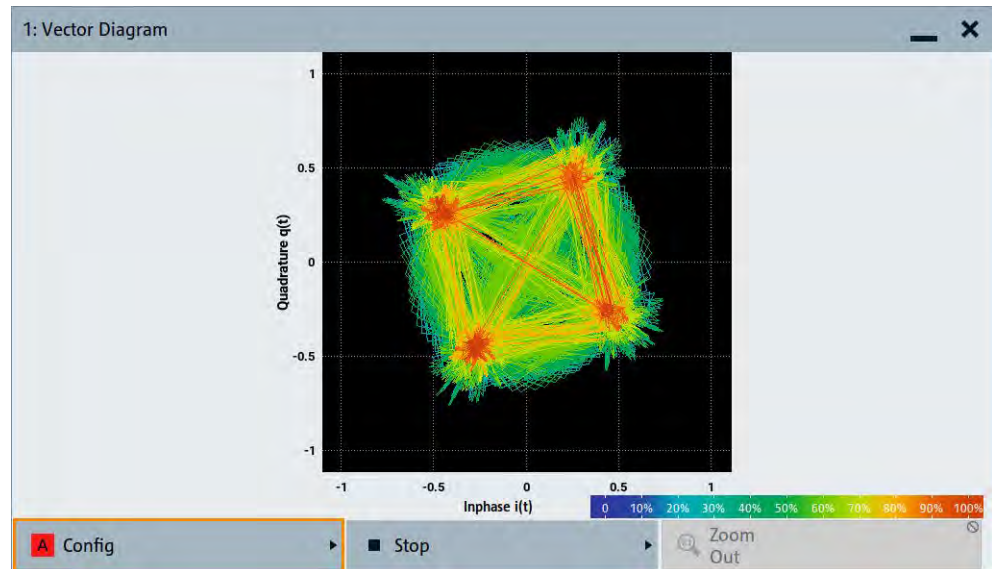

Figure 9-13: Rotating vector diagram

6. Reset the baseband frequency offset to 0 Hz.  
The vector diagram does not rotate anymore.

### To filter the generated signal

This step-by-step instruction provides information on how to apply roll off filtering on the generated signal with a root raised cosine filter.

1. Select "Baseband" > "Custom Digital Mod".
2. Select "Filter" > "Roll Off Factor" = "0.99".

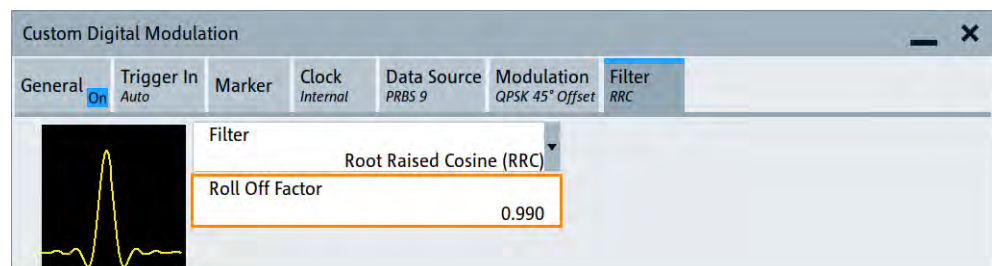

The vector diagram changes.

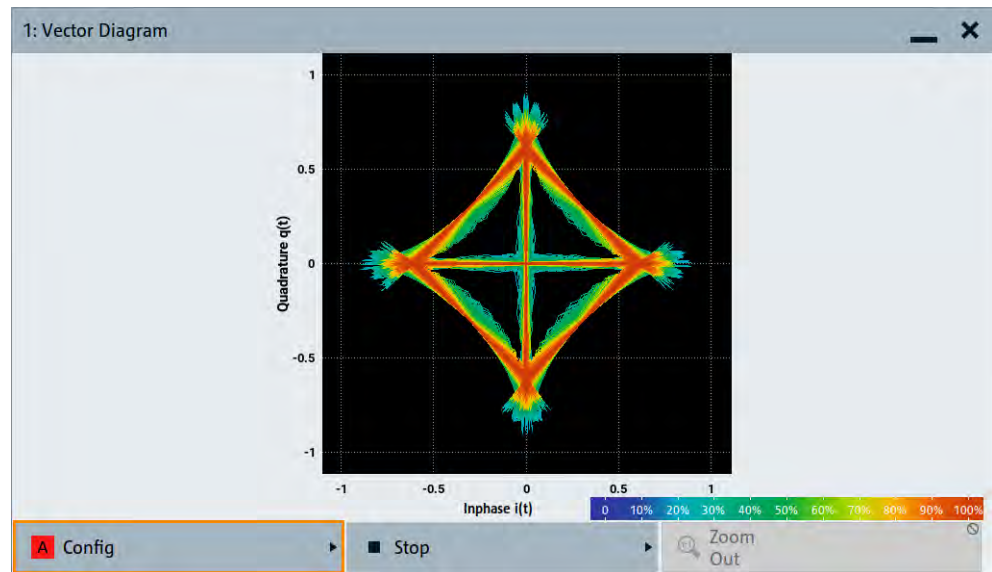

3. Preset the rolloff factor.

### To apply signal path gain and check signal routing

The power spectrum diagram is a suitable representation of the effect of these settings.

1. In the vector diagram, select "Config".
2. In the "Graphics Configuration" dialog, select the following:
  - a) Select "Mode" > "Power Spectrum".
  - b) Select "Source" > "RF".
  - c) Select "Apply Changes".

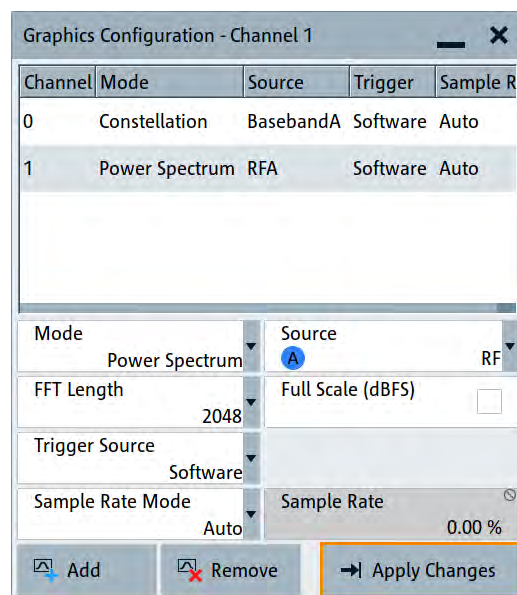

3. In the "Baseband Offsets" dialog, set "Baseband" > "Frequency Offset" = "5 MHz".

The power spectrum confirms the shifted WCDMA-3GPP signal.

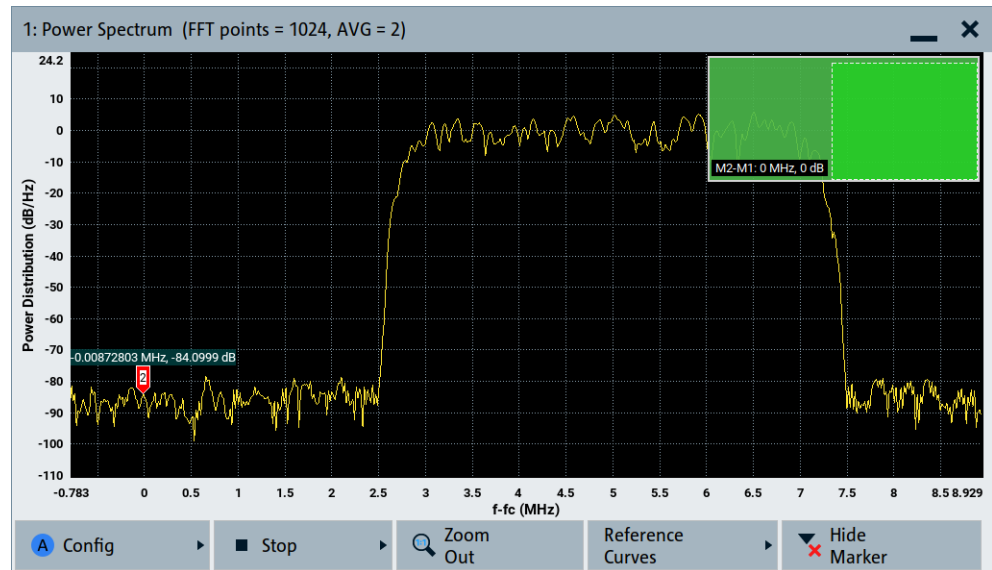

**Figure 9-14: Power spectrum with shifted WCDMA-3GPP signal and marker for measuring the offset**

4. Select "Baseband B" > "Custom Digital Mod" > "State" > "On", to enable a custom digital modulation with the default GSM signal.
5. Select "Baseband B" > "Signal Routing" > "route to path A" to route both signals to the first path
6. In the "Baseband B" > "Baseband Offsets" dialog, set "Baseband B" > "Gain" = "-30 dB" to attenuate the GSM baseband signal.

Baseband Offsets			
	Frequency Offset (Hz)	Phase Offset (deg)	Gain (dB)
Baseband A	5 000 000.00	0.00	0.000
BB Input A	0.00	0.00	0.000
BB Input B	0.00	0.00	0.000
Baseband B	0.00	0.00	-30.000

The power spectrum diagram displays two signals, an attenuated GSM signal and the shifted WCDMA signal.



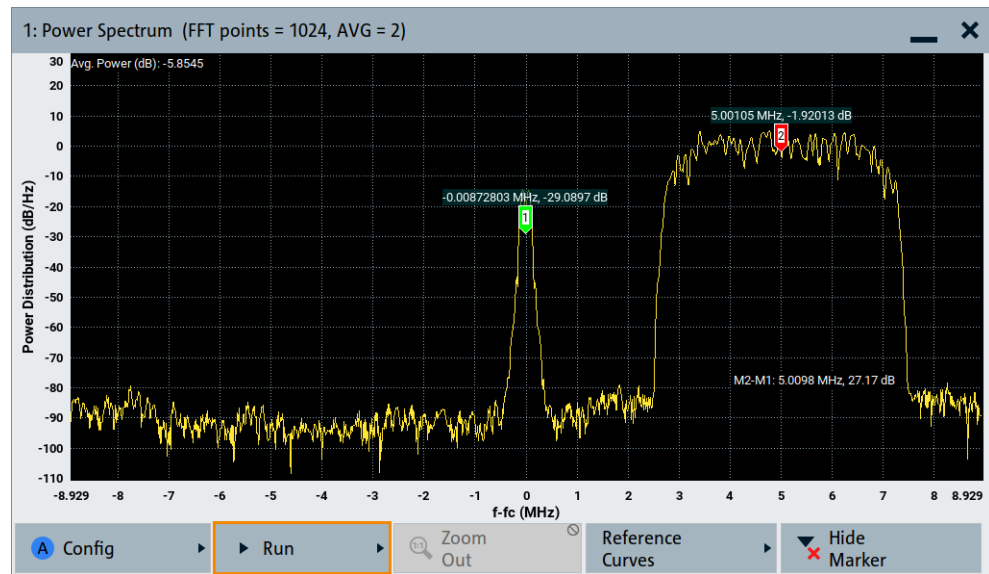

Figure 9-15: Power spectrum with attenuated GSM signal and shifted WCDMA signal

At the RF output, the GSM signal appears attenuated with 15 dB only because the power level is measured with a large bandwidth.

For details, see [Section 9.2, "Querying baseband power levels"](#), on page 645.

7. Zoom in the relevant area of the diagram.  
See ["To zoom into a diagram"](#) on page 641.
8. Enable markers to readout the measured data, for example the frequency offset or the power level of the signals.  
See ["To enable markers to read-out measured data"](#) on page 642.
9. Select "Baseband" > "Baseband Offsets" > "Frequency Offset" = "0 Hz", to disable the frequency offset.
10. Select "Baseband B" > "State" > "Off", to disable the GSM signal.

### To zoom into a diagram

In an enlarged diagram:

1. Use the one-finger zoom to zoom with a fixed zoom factor.
2. Use the two-finger zoom to do a custom zoom.  
This zoom works like the two-finger pinching for magnifying images on your mobile phone.  
If the diagram is zoomed, an overview window appears.
3. Move the visible area in the graphics or in the overview window.
4. For the reverse operation, select "Zoom out".

### To enable markers to read-out measured data

In an enlarged diagram:

1. Select "Show Marker".

Two markers appear, one over the other.

2. To position the markers, select and shift them.

"M2-M1" indicates the distance of marker 1 and marker 2 on the x-axis (left value) and on the y-axis (right value).

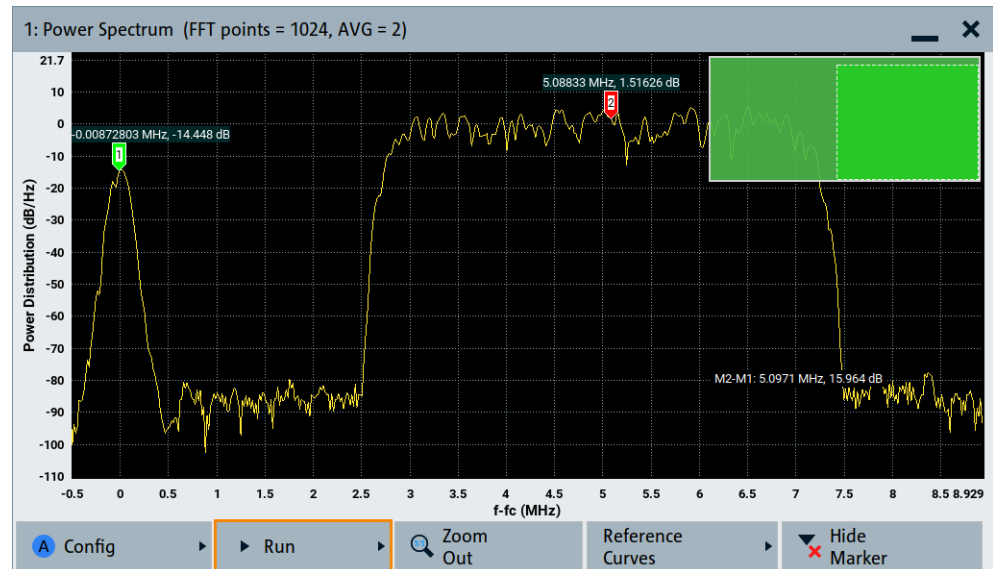
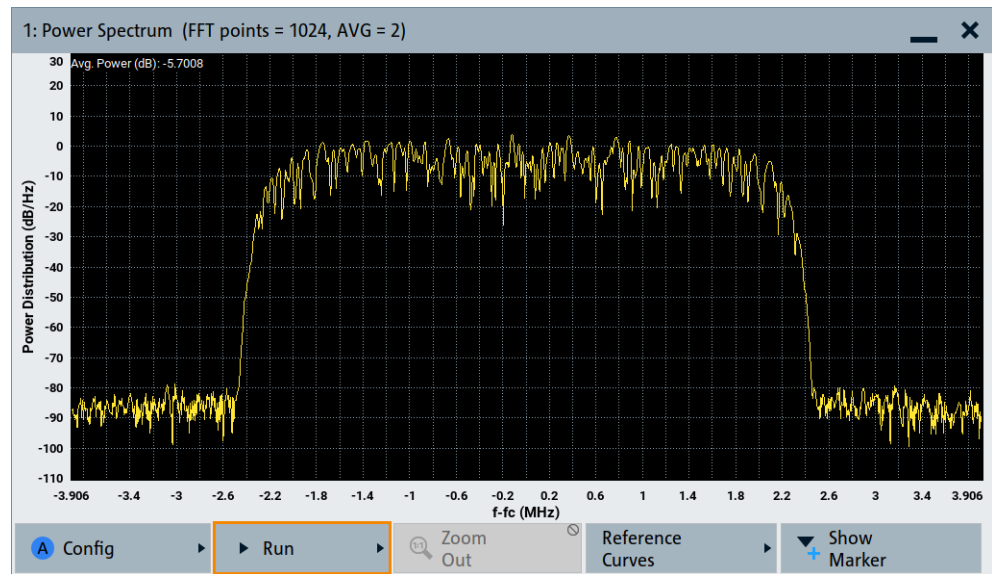

Figure 9-16: Power spectrum with GSM and WCDMA signals and markers

3. To hide the markers, select "Hide Marker".

### To observe the effect of fading

1. Open the RF power spectrum of the WCDMA-3GPP signal without baseband offsets as in ["To apply signal path gain and check signal routing"](#) on page 639.



The display confirms the WCDMA-3GPP spectrum with a maximum level at around -10 dBm.

2. Select "Fading A" > "On" to enable the fading simulator.

The power spectrum diagram shows the same shape, but the level changes dynamically.

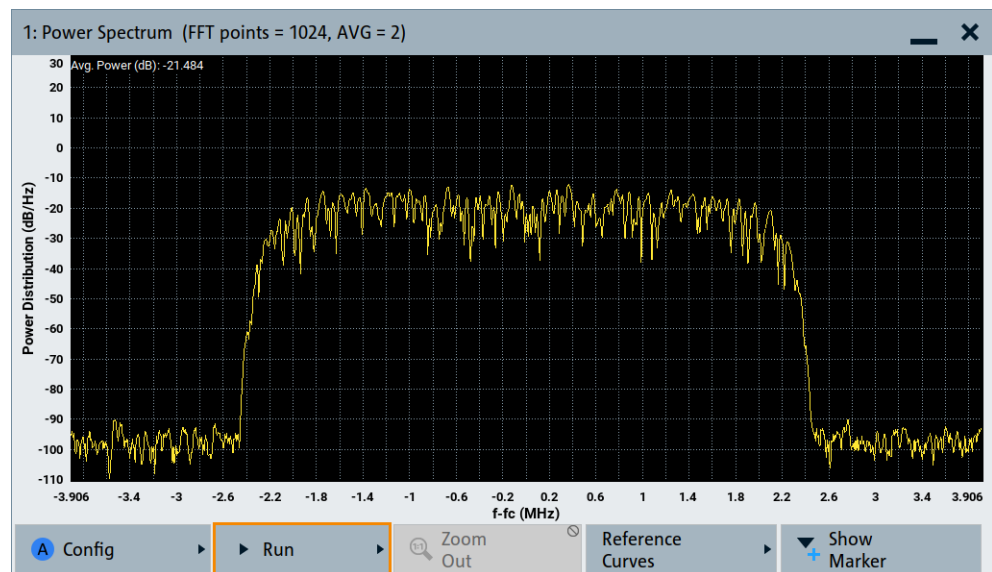

#### To observe the effect of enabled additive noise (AWGN)

1. Select "AWGN" > "General".
2. Select "Mode" > "Additive Noise".
3. Select "Min Noise/System Bandwidth Ratio" = "3".
4. Select the tab "Noise Power / Output Results".

5. Select "Carrier/Noise Ratio" = "30 dB".

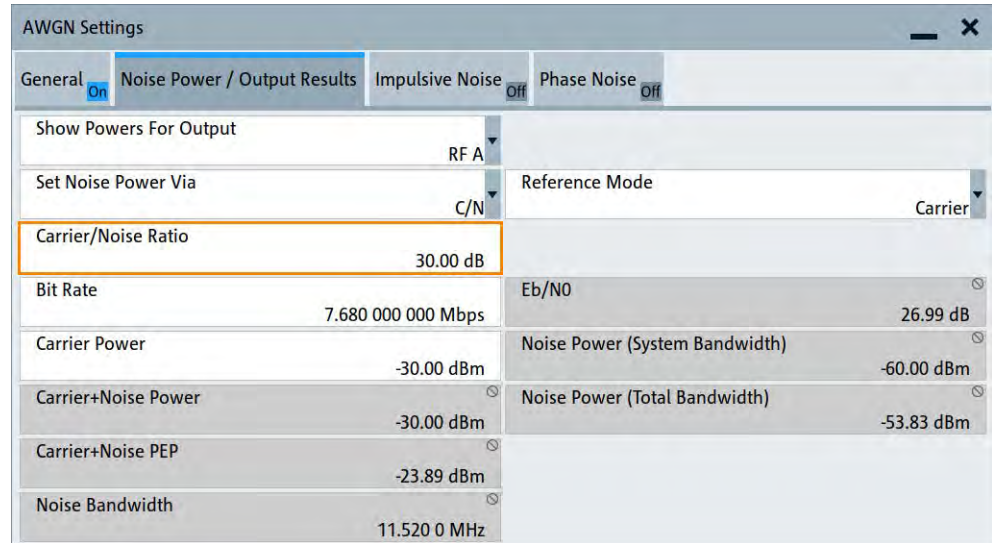

6. Select "AWGN" > "On"
7. Observe the power spectrum display.

In addition to the changing level from fading, the power spectrum shows a noise floor with constant level. Also, the power spectrum shows the digitally modulated signal over the whole bandwidth. In this case, the WCDMA signal has a bandwidth of 3.84 MHz.

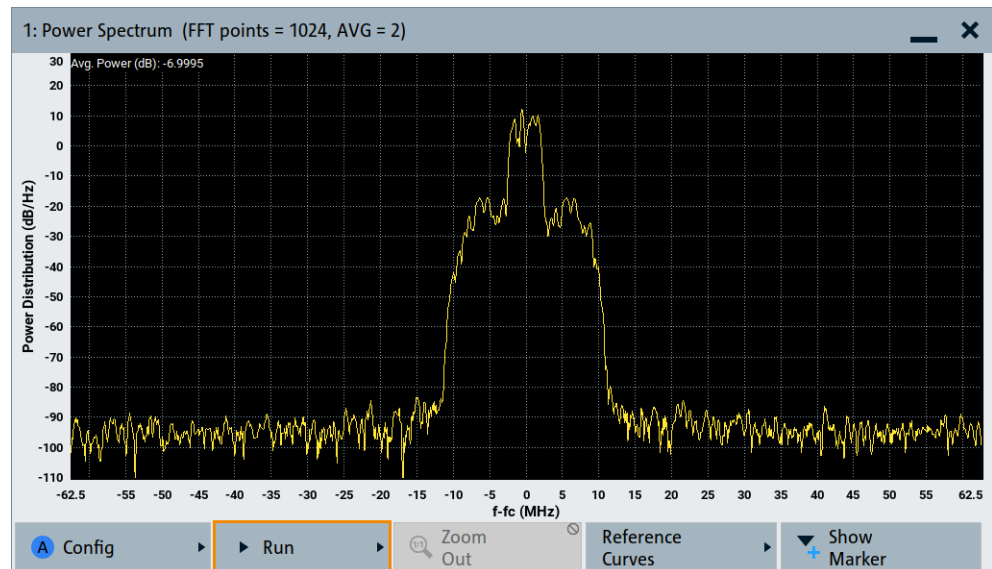

### To print the current power spectrum

1. Press HCOPY.
2. Use the default settings.
3. Select "Save".

The instrument creates a screenshot of the current screen and stores it in a file with a predefined filename in the default user directory `/var/user/`.

See [Section 11.10, "Creating screenshots of current settings"](#), on page 731.

4. Use one of the standard file transfer methods to access the user directory of the instrument. Transfer the file to a PC.

See [Section 11.9, "Transferring files from and to the instrument"](#), on page 725.

5. Print the file content.

## 9.2 Querying baseband power levels

The R&S SMW200A provides a flexible configuration of the signal power at different processing points of the signal flow. The configuration implies various interdependent parameters grouped in different dialog boxes. This section focuses on the "Baseband Powers" measurement functionality provided for retrieving the power and peak power of the digital baseband signal at configurable acquisition points. E.g., at the input or the output of the fading block, the I/Q output connectors, etc. The provided measurement results are based on signal measurement with different acquisition methods.

The [Section 9.2.2, "About leveling"](#), on page 645 provides general information on leveling as well as a background information on the leveling principle used in the instrument. Understanding of this principle is a prerequisite for the correct interpretation of the displayed measurement results.

Refer to [Section 9.2.4, "Measuring baseband power levels"](#), on page 654 for examples on using the baseband power measurements.

### 9.2.1 Required options

The minimum equipment layout for using this function includes

- Option standard baseband generator (R&S SMW-B10) per signal path
- Option baseband main module, one or two I/Q paths to RF (R&S SMW-B13/-B13T)

### 9.2.2 About leveling

The instrument provides different signal routing possibilities, also involving signal summing and enabling of power offsets.

This section does not focus on all possible alternatives but rather on the principle of signal leveling. For a detailed description refer to:

- [Section 4.2, "Possible ways to configure the signal flow"](#), on page 105
- [Section 4.5, "Signal routing settings"](#), on page 147
- [Section 4.2.2, "Using the system configuration capabilities"](#), on page 106
- [Section 4.4.2, "I/Q stream mapper settings"](#), on page 127
- [Section 5.14, "Shifting the baseband signal"](#), on page 418

- [Section 6.2, "Adding noise to the signal"](#), on page 424

### Baseband leveling principle

In the R&S SMW200A, signal routing is performed in the digital domain, i.e. before the I/Q modulation and the RF upconversion. This implementation ensures a lossless signal addition with high precision. In the digital domain however, real RF levels do not exist. To let you define baseband signals with different average levels, the R&S SMW200A introduces the concept of baseband leveling. This principle bases on a *relative leveling of the baseband signals in the digital domain*.

By default, when two identical baseband signals are added, they are output at the RF output with the equal average levels. To set a relative level between the baseband signals, use one of the possible alternatives, e.g:

- Enable "Baseband" > "Baseband Offsets" > "Gain".
- In MIMO configurations, select "Fading" > "Fading Settings" and adjust the MIMO correlation matrix.
- In non-MIMO configurations, enable "Fading" > "Summation Ratio A/B".
- Some of the digital standards also provide additional level reference settings to determine a power offset or the way the power is calculated.

#### 9.2.2.1 About the power level surveillance

When routing the signal to the I/Q output connectors of the instrument, the signal power is an important parameter. It is also important when adding signals from several baseband sources or applying baseband power offsets or fading the signal.

For example, when measuring the power after fading the peak and RMS power values can fluctuate significant due to the varying channel state information (CSI) of the fading process. The retrieving of correct measurement results for the faded signal requires a suitable acquisition point. Also, it requires a sufficient (long enough) measurement time to allow the power results to converge to reliable values for the long channel state information. Similar situation and requirements apply when measuring the carrier power and the carrier+noise power before and after an AWGN block.

Use the observed information for an evaluation and verification of the correct signal processing throughout the instrument and for a correct adjustment of the power settings at the connected device.



The power values observed in the "Baseband Power Simulation" dialog are suitable as control mechanism. The values cannot be modified to influence the power and level control in the instrument.

#### 9.2.2.2 Defining suitable acquisition points

The [Figure 9-17](#) shows an overview of the possible signal acquisition points.

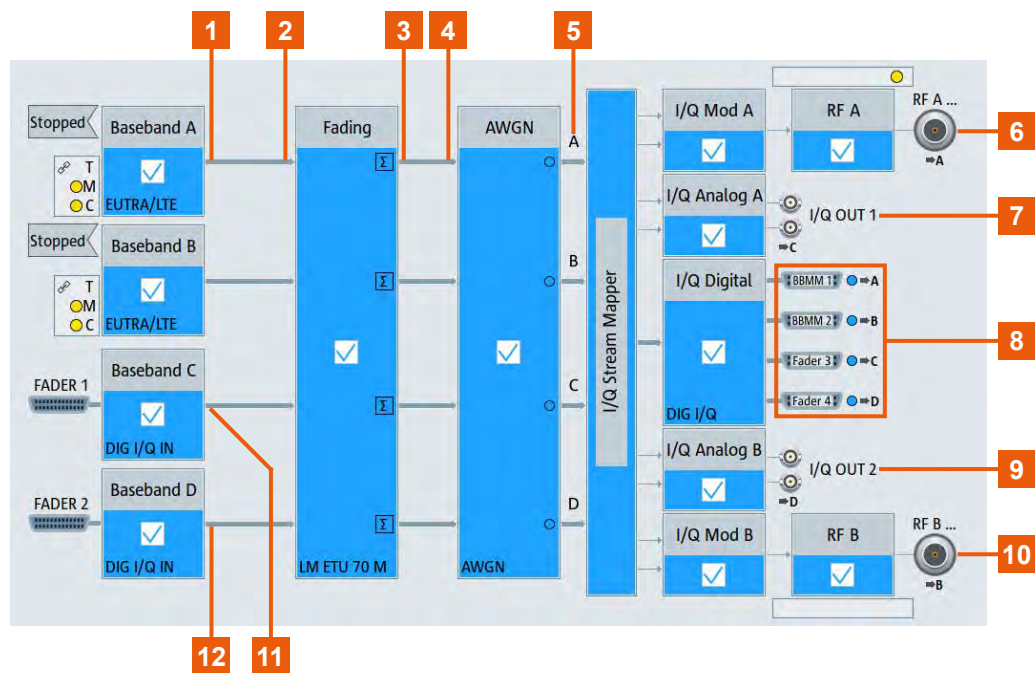

Figure 9-17: Overview of the acquisition points (source) and output points

- 1 = Baseband A/B/C/D
- 2 = Fading input A/B/C/D
- 3 = Fading output A/B/C/D
- 4 = AWGN input A/B/C/D
- 5 = Stream A/B/C/D
- 6, 10 = RF output: RF A/B (A/B)
- 7, 9 = I/Q analog output: I/Q OUT 1/2 (C/D)
- 8 = Dig I/Q output: BBMM 1/2 (A/B), FADER 3/4 (C/D)
- 11, 12 = Dig I/Q input: FADER 1/2 (C/D)

- Depending on the current routing, the signal at the input of the fading block (2) can be:
  - One or more the basebands (1)
  - The sum product of the corresponding internal baseband and external digital baseband signal (11, 12).

Enabled power offsets are considered.

- The signal at the fading output (4) is the faded signal if fading is enabled or the sum product of the input signals if summation after the fading is performed. Enabled power offset is considered.
- The signal measured at the acquisition points "Stream A/B/C/D" (5) is the signal after the AWGN block (3). Depending on the AWGN settings, performed are measurement on interference-free digital I/Q baseband signal or the signal superimposed by the noise generator AWGN.
- The points (6) to (10) represent the possible outputs for the corresponding analog, digital or RF output. The measured values are displayed in the current units of the corresponding output.

Enabled power offsets are considered (see also [Section 9.2.2.4, "Understanding the displayed measurement results"](#), on page 649).

### 9.2.2.3 Selecting a suitable acquisition method

The provided measurement results are based on signal measurement with different acquisition methods. Select the acquisition method most fitting to your current task.

Depending on whether the displayed power values are pre-calculated or measured, there are two acquisition approaches:

- Static results
  - In "Nominal" acquisition mode, the displayed power and peak values are statistical *theoretical* values as calculated by the instrument.
- Measured results
  - "Continuous"
    - The displayed power values are determined upon analysis of the complete signal. The sweep time of the performed measurement is selectable, see ["Sweep Time/Duration"](#) on page 652.
    - This acquisition method is suitable for measurements of continuous signals, the sum product of correlated signals, and time varying signals
  - "Gated"
    - The displayed single RMS and peak values are determined upon evaluation of a specific signal segment. The values are the result of one measurement of signal segments at which a selected marker signal is high. Any of the "Marker 1/2/3" can be used, where the marker signals always relate to the current baseband signal source.
  - "Multi Gated"
    - In this acquisition mode, the instrument initiates a set of submeasurements and displays the measurement results separately on different lines.
    - The measurement function uses the two used-defined marker signals, the "Marker 2/3", as they are enabled for the current baseband signal source. The signal "Marker 2" serves as an "init. marker signal" signal that determines the repetition window; the signal "Marker 3" is a user-defined marker signal and defines different gates in this repetition window. The term gate describes the time from a rising edge to a subsequent falling edge of the marker signal. For example, the "Marker 3" signal illustrated on [Figure 9-18](#) defines three gates.



**Figure 9-18: Marker signals used in multi-gated acquisition measurement**

Marker 2 = init. marker signal

Marker 3 = user-defined marker signal



In multi-gated acquisition mode, the measured values of different gates are displayed as separate submeasurements, i.e. not combined in one result as in the gated mode. However, the submeasurement results for the same gate index performed in consecutive repetition windows are combined to smoothen RMS and peak power depending on measurement duration / sweep time.

**Note:** We recommend that you configure up to 32 submeasurements per measurement, i.e. 32 gates in a repetition window. The repetition window is defined by marker 2 and has to be longer than 100 ms.

This acquisition method is suitable for power measurements on burst signals or pulse signals with different duty cycles. Like, for example, measurement on a periodic signal composed of a preamble, sounding channel and data, where each of these three fields is transmitted with different power.



The displayed power values are suitable as a control mechanism. The values cannot be modified to influence the power and level control in the instrument.

A combination of different measurement acquisition methods can be enabled at each acquisition point. The measurement results are displayed simultaneously in a list.

Refer to [Section 9.2.4, "Measuring baseband power levels"](#), on page 654 for examples on using the provided acquisition methods and their application fields.

#### 9.2.2.4 Understanding the displayed measurement results

The following rules apply by the calculation and display of the measurement results:

- The displayed power values refer to the selected [Output](#)
- As a reference value serves the 0 dBFS level.
- The results are displayed in the current units of the corresponding [Output](#)  
For example, if an R&S SGT is connected to one of the DIG I/Q Out interfaces, the results are displayed in dBm; the instrument name is also indicated.

#### Checking analog I/Q output levels

1. In the block diagram, select "I/Q Analog A" > "I/Q Analog Outputs".
2. Select "I/Q Level Vp (EMF)" = "1.2 V"

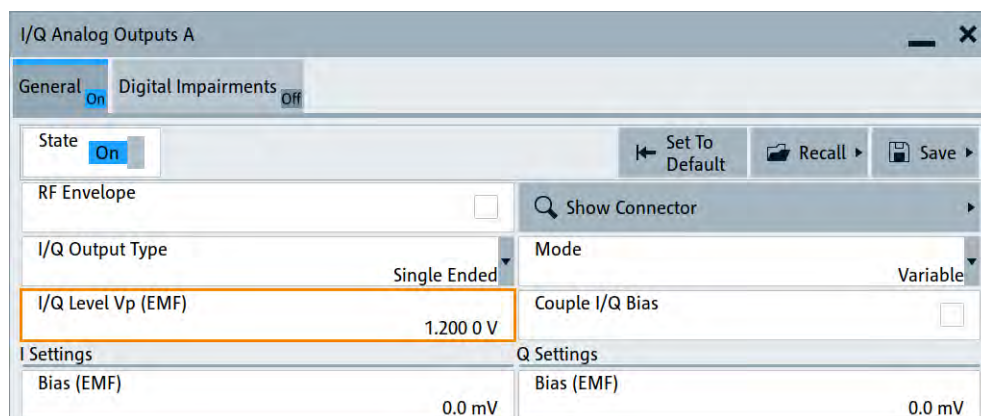

3. Select "Setup" > "General" > "Baseband Powers" to enable a power measurement with the following properties:
  - a) Select "Source" > "Baseband A".
  - b) Select "Output" > "I/Q Out 1".
  - c) Select "Acquisition" > "Nominal".

A full-scale value before the I/Q modulation corresponds to 1.2 V. A -6 dBFS value for RMS or peak corresponds to 0.6 V.

#### Example: Results calculation at the RF output

The reference value for the power calculation at the RF outputs is the "Level" value, as displayed in the status bar. Also we consider a configured power offset, for example "RF" > "RF Level" > "Offset" = "10 dBm".

Set "RF Level" = "5 dBm".

In the "Setup" > "Baseband Powers" dialog, enable a power measurement with the following properties:

- "Source" > "Baseband A"
- "Output" > "RF A"
- "Acquisition" > "Nominal"

The display shows "PEP" = "15 dBm", "Level" = "5 dBm".

### 9.2.3 Baseband power settings

Access:

1. In the taskbar, select "System Config" > "Setup".
2. Select "General" > "Baseband Powers".

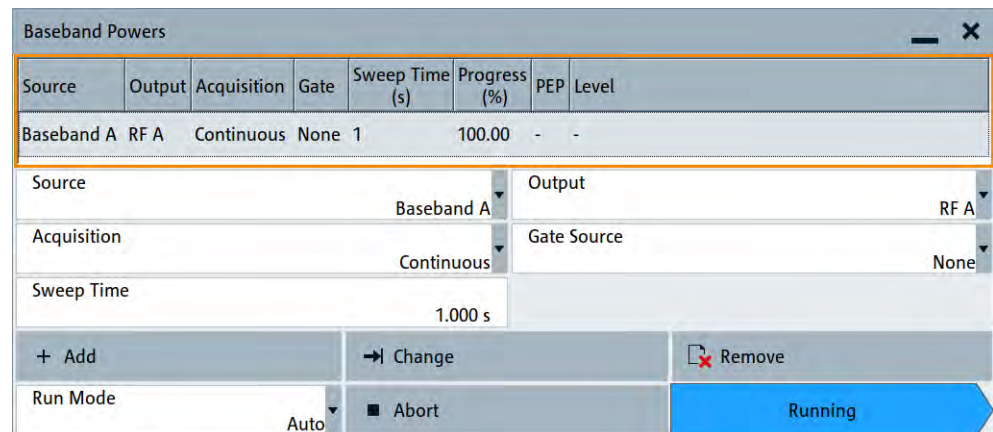

The dialog provides a summarized information on the important baseband level parameters, like power level and peak power (PEP) of selectable acquisition points.

The remote commands required to define these settings are described in [Section 14.19.5.7, "SOURce:BB:MEASurement subsystem"](#), on page 1178.

### Settings:

<a href="#">Baseband powers table</a> .....	651
<a href="#">Source</a> .....	651
<a href="#">Output</a> .....	651
<a href="#">Acquisition</a> .....	651
<a href="#">Gate Source</a> .....	652
<a href="#">Sweep Time/Duration</a> .....	652
<a href="#">PEP/Level</a> .....	652
<a href="#">Run Mode</a> .....	653
<a href="#">Add/Change/Remove/Start/Abort</a> .....	653
<a href="#">Running/Stopped</a> .....	653

### Baseband powers table

Displays the measurement results of all currently enabled measurements.

You can configure and enable up to 8 measurements simultaneously. To enable a new measurement or to change the settings of an existing one, use the [Add/Change/Remove/Start/Abort](#) functions.

"Progress (%)" Indicates the status of an initiated measurement.

Remote command:

[\[:SOURce\]:BB:MEASurement:POWer:PROGress?](#) on page 1182

### Source

Sets the start acquisition point for the power measurement.

The available acquisition points depend on the following system configuration settings:

"System Config" > "Fading/Baseband Config" > "Mode", "Entities", "Basebands" and "Streams" (LxMxN).

Remote command:

[\[:SOURce\]:BB:MEASurement:POWer:SOURce](#) on page 1179

### Output

Sets acquisition endpoint for the power measurement. Available are measurements at all input and output interfaces of each block belonging to the baseband domain.

The available acquisition points depend on the following system configuration settings:

"System Config" > "Fading/Baseband Config" > "Mode", "Entities", "Basebands" and "Streams" (LxMxN).

Remote command:

[\[:SOURce\]:BB:MEASurement:POWer:SOURce](#) on page 1179

[\[:SOURce\]:BB:MEASurement:POWer:OUTPut](#) on page 1179

### Acquisition

Determines the used acquisition method, see [Section 9.2.2.3, "Selecting a suitable acquisition method"](#), on page 648.

Refer to [Section 9.2.4, "Measuring baseband power levels"](#), on page 654 for examples on using the provided acquisition methods and their application fields.

Remote command:

`[ :SOURce ] :BB:MEASurement:POWer:ACQuisition` on page 1180

### Gate Source

In gated and multi-gated measurements, sets/displays the signal used to determine the signal part to be measured.

With "Acquisition" > "Gated", the starting point of the signal measurement is determined by one of the marker signals "Marker 1"/"Marker 2"/"Marker 3", as enabled for the current baseband signal source.

With "Acquisition" > "Multi Gated", the instrument uses the "Marker 2" and "Marker 3" signals, see [Figure 9-18](#).

See also [Section 9.2.4, "Measuring baseband power levels"](#), on page 654.

Remote command:

`[ :SOURce ] :BB:MEASurement:POWer:GSource` on page 1180

### Sweep Time/Duration

"Sweep Time" requires "Run Mode" > "Auto", "Duration" requires "Run Mode" > "Single", see ["Run Mode"](#) on page 653.

Sets the measurement duration or sweep time of the measurement.

#### Note:

If fading is enabled, trigger the measurement with an appropriate duration. To ensure correct average values, proceed as follows:

- Enable a "Run Mode" > "Single"
- Select a measurement period that is long enough to average the fading signal and the channel state information.

In "Acquisition" > "Gated", the value of the parameter "Sweep Time/Duration" relates to the effective time during that the signal is measured; the duration is determined by the corresponding marker/markers signal (high values) and not to as an absolute duration/ sweep time.

#### Example:

A measurement with the following settings:

- "Acquisition" > "Gated"
- Duty cycle of the marker signal used as gate source = 1%
- "Duration"/"Sweep Time" = "1 s"

This measurement lasts effectively 100 s.

Remote command:

`[ :SOURce ] :BB:MEASurement:POWer:DURation` on page 1182

### PEP/Level

Indicates the measured power level and peak power (PEP) retrieved according to the selected acquisition method and at the selected acquisition point.

The power units depend on the selected output measurement point:

- Measurements at the digital output interfaces (for example [BBMM1]) are represented in dBFs, as relative to full scale of 0.5 V
- Measurements at the analog interfaces [I/Q] in mV respectively
- All other measurement results are represented in dBm.

Possible internal gains and attenuations are compensated.

Remote command:

`[ :SOURce ] :BB:MEASurement :POWer :PEAK?` on page 1181

`[ :SOURce ] :BB:MEASurement :POWer :RMS?` on page 1181

### Run Mode

Determines whether the measurements are performed continuously with the selected "Sweep Time" ("Auto") or are executed once ("Single").

"Auto"	This mode is suitable for measurements with short "Sweep Time" and if several measurements are running simultaneously. The measurement results are retrieved and updated continuously.
"Single"	This mode is suitable for measurements with longer measurement time ("Duration"). See also <a href="#">Section 9.2.4, "Measuring baseband power levels"</a> , on page 654.

Remote command:

`[ :SOURce ] :BB:MEASurement :POWer :RMODe` on page 1180

### Add/Change/Remove/Start/Abort

Standard functions for measurement handling, like enabling a new measurement, changing an existing one or starting or stopping the current measurement. You can configure and enable up to 8 measurements simultaneously, each with up to 32 sub-measurements.

To retrieve information on the status of an initiated measurement, observe the "Progress" indication in the [Baseband powers table](#) and the [Running/Stopped](#) indication.

Remote command:

`[ :SOURce ] :BB:MEASurement :POWer :ADD` on page 1180

`[ :SOURce ] :BB:MEASurement :POWer :INDEX` on page 1182

`[ :SOURce ] :BB:MEASurement :POWer :CHANGE` on page 1183

`[ :SOURce ] :BB:MEASurement :POWer :DELETE` on page 1183

`[ :SOURce ] :BB:MEASurement :POWer :EXECute` on page 1183

`[ :SOURce ] :BB:MEASurement :POWer :ABORT` on page 1183

### Running/Stopped

Displays the status (running/stopped) of the current measurement.

Remote command:

`[ :SOURce ] :BB:MEASurement :POWer :RSTate?` on page 1181

## 9.2.4 Measuring baseband power levels

The examples in this section explain how to enable the baseband power measurements with different acquisition methods to measure different types of signals. The measurements require a baseband signal. In these examples, we use a base unit equipped with the firmware option R&S SMW-K54 IEEE 802.11a/b/g/n and generate a WLAN signal with suitable frame and marker configuration.

The following tasks do not require special knowledge on the IEEE 802.11 standard; a basic understanding on working with the option is however a prerequisite.

### To measure the baseband power via continuous acquisition

The baseband power measurements using continuous acquisition analyze the complete signal. Perform the following settings to generate a non-bursted WLAN 802.11n signal in "Baseband A", "Baseband B", route, and sum both signals and measure the influence of the baseband signals on the generated signal in all these cases.

1. Press the PRESET key.
2. In the block diagram, select "Baseband A" > "IEEE 802.11" to configure the following:
  - a) Select "IEEE 802.11" > "Frame Blocks".
  - b) Set "Frame Block 1" > "Idle Time" = "0 ms".
  - c) Select "IEEE 802.11" > "General".
  - d) Set "State" > "On".

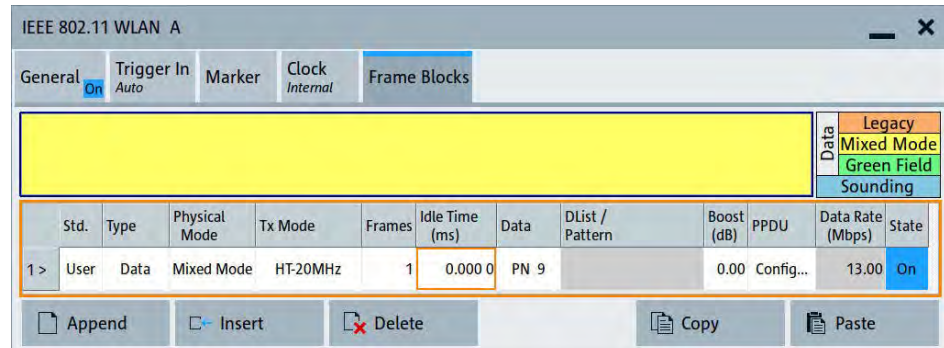

3. In the taskbar, select "System Config" > "Setup" > "Baseband Powers" to configure the following:
  - a) "Source" > "Baseband A"
  - b) "Output" > "RF A"
  - c) "Acquisition" > "Continuous"
  - d) "Sweep Time" = "1 s"
  - e) "Run Mode" > "Auto"
  - f) Select "Add"
  - g) Select "Start" to trigger the measurement.

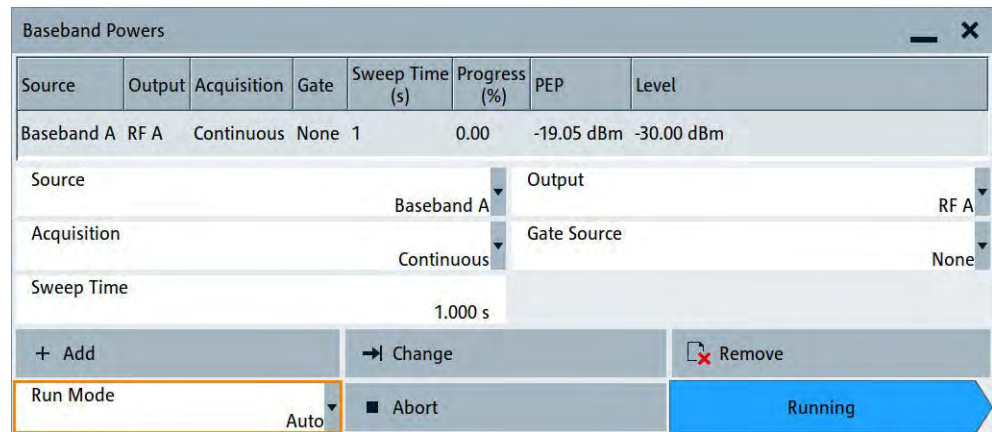

The measurement is running automatically with a sweep time of 1 s. The dialog displays the measured values in the units of the RF output signal: "Level" = "-30 dBm" and "PEP" = "-19.05 dBm". These values are identical to the "Level" and "PEP" values displayed in the status bar.

4. In the block diagram, select "Baseband B" > "IEEE 802.11" to enable the same settings as in the first baseband.
5. Select "Baseband B" > "Signal Routing" > "route to path A and B".  
The signals of "Baseband A" and "Baseband B" are summed and routed to the RF A output.
6. In the taskbar, select "System Config" > "Setup" > "Baseband Powers" to configure an analogical measurement for baseband B:
  - a) Select "Source" > "Baseband B".
  - b) Configure the same settings as in step 3 b) to 3 g).

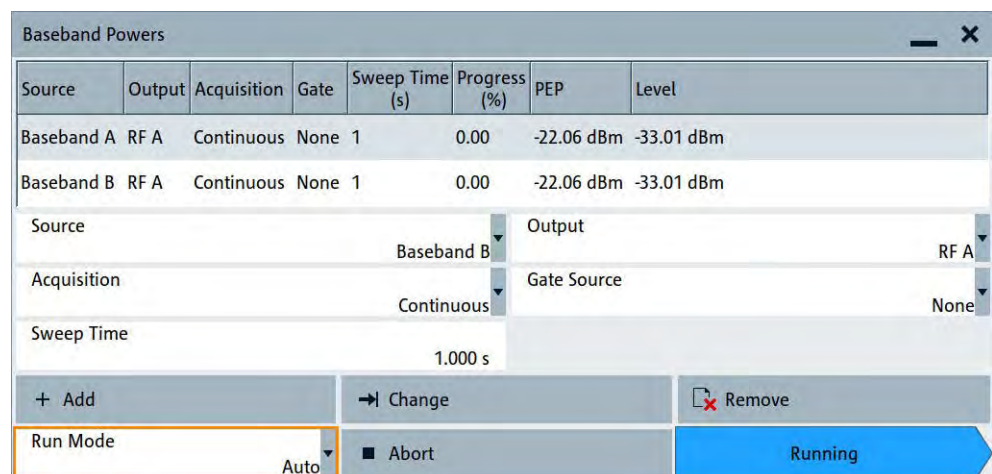

Two simultaneous measurements are running. The dialog displays identical measured values "Level" = "-33.01 dBm" and "PEP" = "-22.06 dBm" for both measurements.

In the R&S SMW200A, when two identical baseband signals are added, they are output at the RF output with equal average levels. In the status bar, the parameter "Level" = "-30 dBm" determines the level of the sum signal at the RF output: The measured level values for each of the baseband signals are 3.01 dB lower than this sum level.

7. Attenuate the baseband power level of path B:
  - a) In the block diagram, select "Baseband B" > "Baseband Offsets".
  - b) Set "Baseband B" > "Gain" = "-3 dB".

	Frequency Offset (Hz)	Phase Offset (deg)	Gain (dB)
Baseband A	0.00	0.00	0.000
BB Input A	0.00	0.00	0.000
BB Input B	0.00	0.00	0.000
Baseband B	0.00	0.00	-3.000

Both baseband signals are summed but the signal of "Baseband A" is 3 dB higher than "Baseband B" in the second path.

8. Compare the measurement results:
  - a) Open the "Baseband Powers" dialog.
  - b) Select "Start".

Source	Output	Acquisition	Gate	Sweep Time (s)	Progress (%)	PEP	Level
Baseband A	RF A	Continuous	None	1	0.00	-20.81 dBm	-31.77 dBm
Baseband B	RF A	Continuous	None	1	0.00	-23.81 dBm	-34.77 dBm

Source: Baseband B, Output: RF A, Acquisition: Continuous, Gate Source: None, Sweep Time: 1.000 s

+ Add    → Change    Remove    Run Mode: Auto    Abort    Running

The influence of both signals on the output RF signal is different; the measured values confirm that the signal of "Baseband B" is 3 dB lower than the signal of the "Baseband A". The level of the sum signal is still  $-31.77 \text{ dBm} + -34.77 \text{ dBm} = -30 \text{ dBm}$ .



The measurements are performed once: "Run Mode" > "Single". The "Duration" is the measurement time.

The displayed measured values are accurate and differ from the theoretical nominal values. The baseband power measurements consider enabled power offsets and signal routing. With suitable acquisition points and method, you can measure the influence of an enabled fading simulator or detect the configured signal-to-noise value in the AWGN generator.

### To measure the baseband power via gated acquisition

The baseband power measurements using gated acquisition use marker signals to determine the particular part of the signal to be analyzed. Perform the following settings to generate a bursted WLAN 802.11n signal consisting of two frame blocks with idle periods between them.

1. Press the PRESET key.
2. In the block diagram, select "Baseband A" > "IEEE 802.11" to configure the following:
  - a) Select "IEEE 802.11" > "Frame Blocks".
  - b) Select "Append" to configure "Frame Block 2".
  - c) Set "Frame Block 2" > "Boost" = "-5 dB".
  - d) Set "Frame Block 2" > "State" = "On"
  - e) Set "IEEE 802.11" > "General" > "State" > "On".

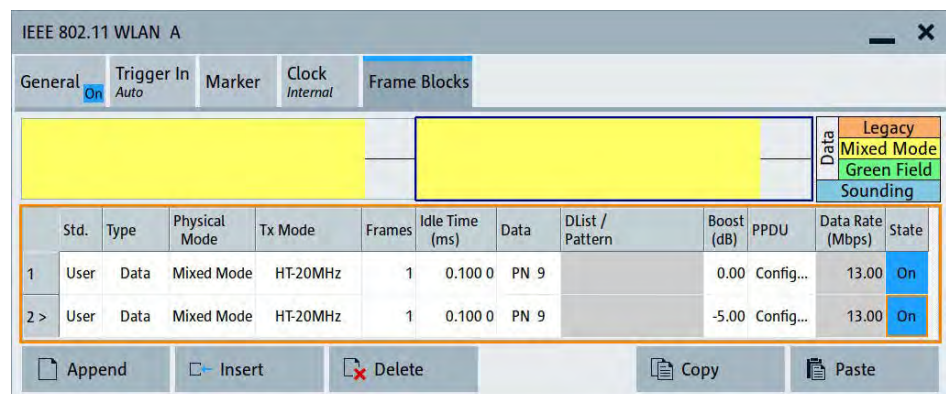

3. Select "802.11" > "Marker" to enable two marker signals, each one indicating of the PPDU part of the frame block:
  - a) Select "Marker 1" > "Mode" > "Frame Active Part".

- b) Set "Frame Block Index" = "1" that results in "Frame Index" = "1".

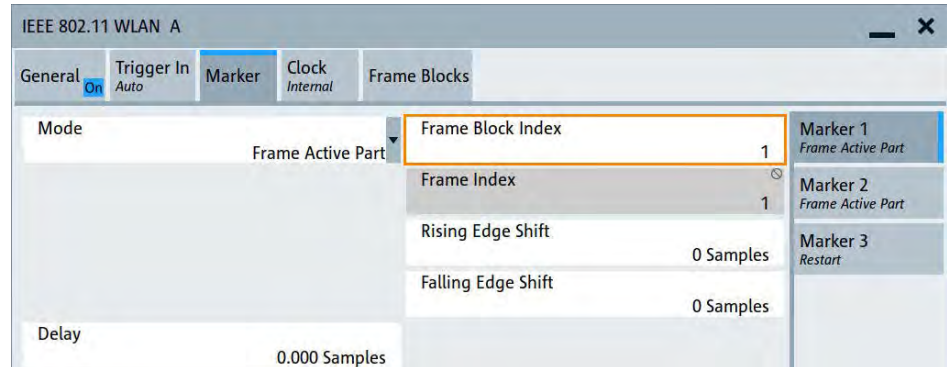

- c) Select "Marker 2" > "Mode" > "Frame Active Part".  
 d) Set "Frame Block Index" = "2" that results in "Frame Index" = "1".

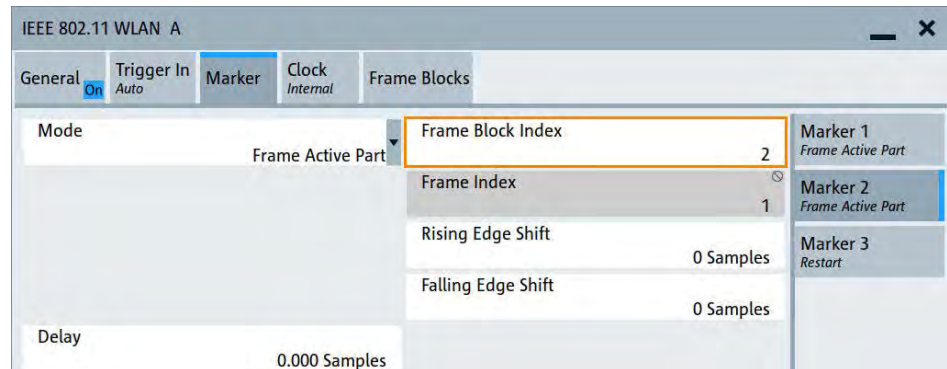

4. In the taskbar, select "System Config" > "Setup" > "Baseband Powers" to configure the following:
- Select "Source" > "Baseband A".
  - Select "Output" > "RF A".
  - Select "Acquisition" > "Gated".
  - Select "Gate Source" > "Marker 1".
  - Set "Run Mode" > "Single".
  - Set "Duration" = "1 s".
  - Select "Add".
  - Set "Start" to trigger the measurement.

The screenshot shows the 'Baseband Powers' application window. The main table displays the following data:

Source	Output	Acquisition	Gate	Duration (s)	Progress (%)	PEP	Level
Baseband A	RF A	Gated	Marker 1	1	100.00	-19.05 dBm	-30.00 dBm

Below the table, the configuration is shown with dropdown menus:

- Source: Baseband A
- Output: RF A
- Acquisition: Gated
- Gate Source: Marker 1
- Duration: 1.000 s

At the bottom, the 'Run Mode' is set to 'Single', and the 'Start' button is highlighted with an orange border.

The baseband power application executes a single measurement. The signal "Marker 1" indicates the active part of the first frame block. The measured result confirms the expected level of -30 dBm. The power level in the first frame block is not amplified: "Frame Block 1" > "Boost" = "0 dB".

5. Reconfigure the gate source:
  - a) Select "Gate Source" > "Marker 2".
  - b) Press "Change".
  - c) Select "Start" to trigger the measurement.

The screenshot shows the 'Baseband Powers' application window after reconfiguration. The main table displays the following data:

Source	Output	Acquisition	Gate	Duration (s)	Progress (%)	PEP	Level
Baseband A	RF A	Gated	Marker 2	1	100.00	-19.05 dBm	-35.00 dBm

Below the table, the configuration is shown with dropdown menus:

- Source: Baseband A
- Output: RF A
- Acquisition: Gated
- Gate Source: Marker 2
- Duration: 1.000 s

At the bottom, the 'Run Mode' is set to 'Single', and the 'Start' button is highlighted with an orange border.

Performed is one single measurement. The signal "Marker 2" indicates the active part of the second frame block. The measured result confirms the expected level of -35 dBm that results from the attenuation of frame block 2: "Frame Block 2" > "Boost" = "-5 dB".

### To measure the baseband power via multi-gated acquisition

The baseband power measurements using multi-gated acquisition use marker signals, "Marker 2" and "Marker 3", to determine the measurement period and the particular part of the signal to be analyzed. Perform the following settings to generate a bursted WLAN 802.11n signal consisting of three frame blocks with short active parts and different long idle periods between them.

This example is based on the predefined marker signals. The goal is to capture and measure the short active frame parts to explain the measurement in principle. In your particular case, you typically measure some exact signal parts or even frame parts and you have to define one or more customized marker signals.

1. Press the PRESET key.
2. In the block diagram, select "Baseband A" > "IEEE 802.11" to configure the following settings:

IEEE 802.11 WLAN A												
General		Trigger In		Marker		Clock		Frame Blocks				
On		Auto		Stop		Internal						
											Legacy	
											Mixed Mode	
											Green Field	
											Sounding	
Std.	Type	Physical Mode	Tx Mode	Frames	Idle Time (ms)	Data	DList / Pattern	Boost (dB)	PPDU	Data Rate (Mbps)	State	
1	User	Data	Mixed Mode	HT-20MHz	1	100.000 0	PN 9		0.00	Config...	13.00	On
2	User	Data	Mixed Mode	HT-20MHz	1	150.000 0	PN 9		-5.00	Config...	13.00	On
3 >	User	Data	Mixed Mode	HT-20MHz	1	220.000 0	PN 9		0.00	Config...	13.00	On

Append    Insert    Delete    Copy    Paste

The baseband signal is a burst signal with different and short duty cycles of around 1 %.

3. Select "IEEE 802.11" > "Marker" to enable the two marker signals. The [Figure 9-19](#) shows an example of a marker configuration for measuring the baseband power of the second frame block.

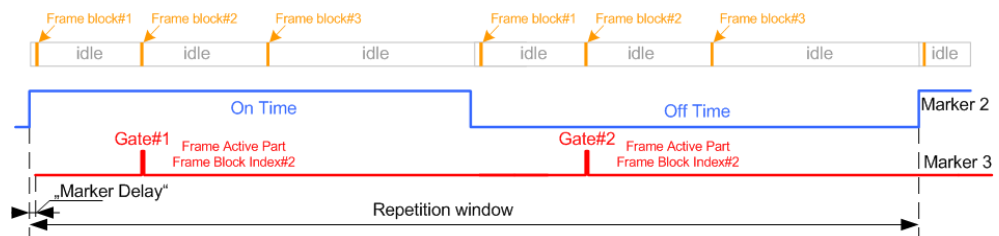

**Figure 9-19: Example: Marker configuration for multi-gated baseband power measurements.**

4. Configure, for example, the following:

- a) Select "Marker" > "Marker 2" > "Mode" > "On/Off Ratio", "On Time" = "16 MSamples", "Off Time" = "16 MSamples".

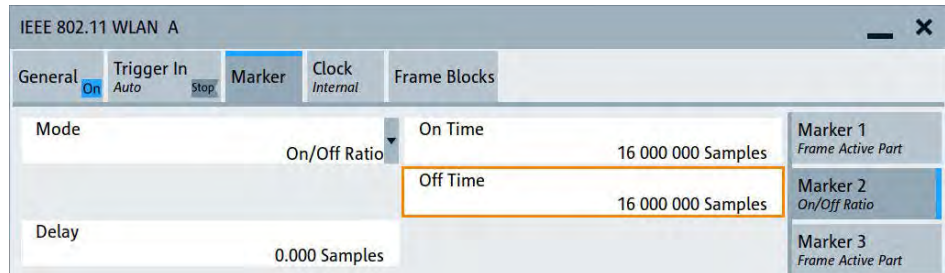

The signal "Marker 2" determines the repetition window. The set "On Time" is long enough so that the measurement captures several gates of the signal "Marker 3".

- b) Select "Marker 3" > "Mode" > "Frame Active Part" and "Frame Block Index" = "2".  
 c) Select "Delay" > "5 Samples" to make sure that this marker signal is within the measurement period.

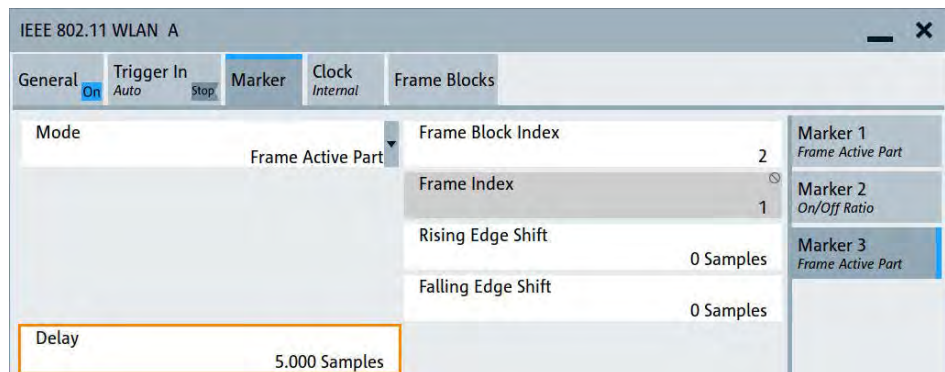

5. Select "IEEE 802.11" > "General" > "State" > "On".
6. In the taskbar, select "System Config" > "Setup" > "Baseband Powers" to configure the following:
- Select "Source" > "Baseband A".
  - Select "Output" > "RF A".
  - Select "Acquisition" > "Multi Gated".
  - Select "Gate Source" > "Multi Gated".
  - Set "Run Mode" > "Single".
  - Set "Duration" = "0.1 s".
  - Select "Change".

h) Set "Start" to trigger the measurement.

Source	Output	Acquisition	Gate	Duration (s)	Progress (%)	PEP	Level
Baseband A	RF A	Multi Gated	Multi Gated	0.1	100.00	-24.06 dBm	-35.00 dBm
						-24.06 dBm	-35.00 dBm
						-24.06 dBm	-35.00 dBm
						-24.06 dBm	-35.00 dBm

Source: Baseband A, Output: RF A, Acquisition: Multi Gated, Gate Source: Multi Gated, Duration: 0.100 s

+ Add    Change    Remove

Run Mode: Single    Start    Stopped

The single measurement is started and lasts a given measurement time. Observe the progress indication for information on the current progress status. The delivered measurement results of the submeasurements confirm the expected level value of -35 dBm for the second frame block. All submeasurements retrieve equal values because the selected repetition window is large and the measurement captures two gates (two frame active parts of the frame block 2).

## 10 Multi-instrument setups

R&S SMW200A is rarely used as a standalone instrument. Usually, the instrument is connected to a device under test (DUT) or other measurement equipment.

Test setups have different requirements, for example:

- Test setups comprising two or more instruments often require a common reference frequency.
- Generation of beamforming signals requires phase coherent signals.
- Some test setups also require control of the signal generation start and an exact generation start time, for example determined by a defined trigger event.
- In other cases, you need time-aligned simultaneous signals within the instrument or possibly also between multiple instruments.
- MIMO test scenarios can require more than two RF signals, generated by processing the I/Q output signals of the R&S SMW200A by external instruments like the R&S SGT or the R&S SGS.
- Radar echo generation requires a connected R&S FSW.
- etc.

R&S SMW200A provides several settings that help fulfilling these requirements. This section explains the main principles and gives an overview of the related settings and step-by-step instructions.

• <a href="#">Synchronizing instruments</a> .....	663
• <a href="#">Generating phase coherent signals</a> .....	663
• <a href="#">Generating time-aligned baseband signals</a> .....	664
• <a href="#">Generating phase-coherent signals</a> .....	679
• <a href="#">Control and operation of external instruments</a> .....	696

### 10.1 Synchronizing instruments

For information on the possible scenarios concerning the distribution of reference frequency, test setups and the related settings:

See [Section 8.8, "Reference oscillator"](#), on page 491.

### 10.2 Generating phase coherent signals

The R&S SMW200A provides a build-in function that allows a distribution of the local oscillator signal in a way that multiple RF signals can be derived from the same LO signal. LO coupling is mandatory for minimizing the phase fluctuations between these RF signals, as it is, for example, required for the generation of beamformed signals.

For information on the possible scenarios, test setups and the related settings:

See [Section 8.9, "Local oscillator coupling"](#), on page 500.

## 10.3 Generating time-aligned baseband signals

In test setups that combine the signal of two or more instruments and/or basebands it is often required that:

- The signal generation starts at a defined moment
- The signal generation starts simultaneously (or with an exactly defined delay) in:
  - All involved instruments
  - All basebands of the same R&S SMW200A

One possible way to achieve quasi-simultaneous signal start is to trigger the instruments by the same trigger event, for example from a **common trigger source**.

Because of the trigger signal propagation time and the signal processing time, however, this method does not achieve precise time-aligned signals.

To generate **synchronous and time aligned signals** with multiple instruments, use the primary-secondary instrument mode.

This section explains how to use the provided settings to define the signal generation start in the basebands of **multiple instruments**.

For information on simultaneous signal generation in the basebands of the same R&S SMW200A, see "[Simultaneous signal generation start in all basebands](#)" on page 243.

- [Connecting multiple instruments in primary-secondary instrument mode](#).....664
- [Connecting to HS DIG I/Q interfaces](#)..... 672
- [Triggering several instruments with a common trigger signal](#)..... 678

### 10.3.1 Connecting multiple instruments in primary-secondary instrument mode

#### About the primary-secondary instrument mode

When connected in primary-secondary instrument mode, two or more R&S SMW200A or one R&S SMW200A and several other signal generators such as R&S SGT or R&S SMBV can generate synchronous and time-aligned signals.

In this mode, the primary instrument generates and outputs a dedicated synchronization signal (Sync Out), that has to be fed into the secondary instrument. The secondary instrument detects and demodulates the signal, and retrieves both the baseband clock and the trigger signal from it. Secondary instruments can forward the received synchronization signal (Sync In) and output it to trigger further secondary instruments.

#### Synchronization signal

The synchronization signal is a 50 MHz signal that carries the trigger pulse modulated on it. Hence, it provides **joint triggering** and **baseband clock synchronization** at the same time.



Final time alignment can require adding I/Q or trigger delay. However, once synchronization is achieved, the primary-secondary instrument mode ensures triggering reproducibility, if the used waveform, sample rate and cabling are not changed.

### Test setup

Regarding the **synchronization signal**, the instruments can be connected (cascaded) in a daisy chain (see [Figure 10-1](#)).

### Used connectors depending on the installed hardware

Depending on the installed hardware, your R&S SMW200A provides and expects the synchronization signal at different connectors. Moreover, there are different requirements regarding the reference frequency.

Option:	DACW board	Common reference frequency	Sync Out connector	Sync In connector
R&S SMW-B10	-	Required <sup>1)</sup>	USER 6	USER 5
R&S SMW-B9	Revision < 5	Required <sup>1)</sup>	USER 6	USER 5
R&S SMW-B9	Revision ≥ 6	Not required	ADV TRG	ADV CLK

<sup>1)</sup> all instruments in the setup have to use the **same reference frequency**. You can distribute the internal reference frequency of one of the instruments. Distribution is independent for primary or secondary instruments. Alternatively, supply all instruments with an external reference frequency source.

#### 10.3.1.1 Multi-instrument settings

Access:

- ▶ Select "Taskbar" > "System Config" > "System Configuration" > "Multi Instrument".

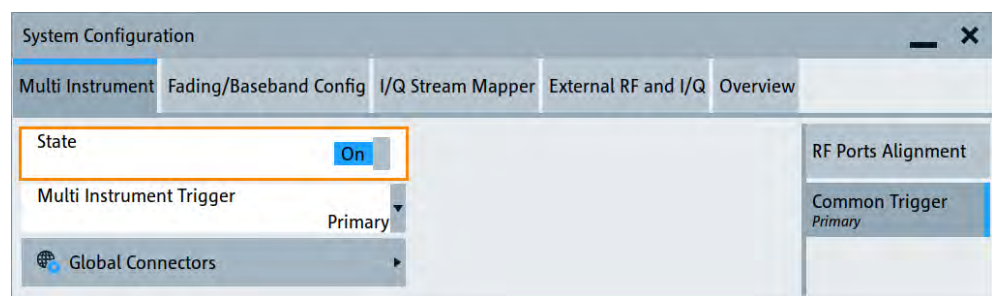

The displayed settings depend on the installed hardware, see ["To connect the instruments and route signals \(R&S SMW-B9, DACW revision ≥ 6\)"](#) on page 670.

For a step-by-step description, see [Section 10.3.1.2, "Connecting and configuring primary-secondary instruments"](#), on page 667.

**Settings:**

State.....	666
Multi Instrument Trigger.....	666
Synchronisation State.....	666
Global Connector Settings.....	666
Show Connector Baseband Sync In/Out.....	667

**State**

Activates the configuration.

With "State" = "Off", the instrument works in a standalone mode.

Remote command:

`:SCONfiguration:MULTIinstrument:STATE` on page 974

**Multi Instrument Trigger**

Sets the mode in that the instrument works.

To activate the mode, set "Multi Instrument" > "State" = "On".

"Primary"	Provides its trigger signal to the secondary instruments.
"Secondary"	Synchronizes to the supplied trigger signal from the primary instrument. Observe the "Synchronisation State" indication for information if the synchronization signal is found and synchronization is achieved.

Remote command:

`:SCONfiguration:MULTIinstrument:MODE` on page 974

**Synchronisation State**

If "Multi Instrument Trigger" = "Secondary", indicates if synchronization is achieved.

"Sync"	Instrument is in sync. It receives and decodes the synchronization and the trigger signal from the primary instrument.
"No Sync"	Synchronization is not achieved, because: <ul style="list-style-type: none"> <li>• The baseband generators in the secondary instruments or in the primary instruments are not activated, see <a href="#">"To start signal generation"</a> on page 671.</li> <li>• There is no physical connection (the synchronization signal is not connected as required). For details, see <a href="#">Section 10.3.1.2, "Connecting and configuring primary-secondary instruments"</a>, on page 667.</li> <li>• The secondary instrument does not detect the synchronization signal.</li> </ul>

Remote command:

`:SCONfiguration:MULTIinstrument:TRIGger:SYNChronization?`  
on page 974

**Global Connector Settings**

Option: R&S SMW-B10 or R&S SMW-B9 with DACW board with revision < 5.

Provides a quick access to the related global connector settings.

With "State" = "On", the synchronization signal is assigned per default as follows:

- "Multi Instrument Trigger" > "Primary"  
"Connector" = "USER 6": "Direction" = "Output", "Signal" = "Baseband Sync Out"
- "Multi Instrument Trigger" > "Secondary"  
"Connector" = "USER 6": "Direction" = "Output", "Signal" = "Baseband Sync Out"  
"Connector" = "USER 5": "Direction" = "Input", "Signal" = "Baseband Sync In"

See also:

- [Section 10.3.1.2, "Connecting and configuring primary-secondary instruments"](#), on page 667.

See also [Section 12.2, "Configuring local and global connectors"](#), on page 742.

### Show Connector Baseband Sync In/Out

Option: R&S SMW-B9 with DACW board with revision  $\geq 6$ .

Displays the physical location of the connectors on the rear panel of the instrument.

The connectors are fixed and cannot be changed. The following connectors are used:

- Sync Out connector: ADV TRG
- Sync In connector: ADV CLK.

See also:

- [Section 10.3.1.2, "Connecting and configuring primary-secondary instruments"](#), on page 667
- ["To connect the instruments and route signals \(R&S SMW-B9, DACW revision  \$\geq 6\$ \)"](#) on page 670.

## 10.3.1.2 Connecting and configuring primary-secondary instruments

### R&S SMW-B9



#### R&S SMW-B9 connectors and setups

Starting from DACW board revision 6, the R&S SMW200A outputs and expects the synchronization signal at the ADV TRG and ADV CLK connectors.

Synchronization signal routing via the USER x connectors is not supported.

#### To check the installed hardware

1. Select [SETUP] > "Instrument Assembly" > "Hardware Config" > "Baseband Assembly".
2. Observe the revision of the installed DACW board.
3. For DACW revision < 5, follow the instructions:
  - ["To connect the instruments and route signals"](#) on page 668
  - ["To configure the primary instrument \(R&S SMW200A\)"](#) on page 669
  - ["To configure the secondary instrument \(R&S SMW200A\)"](#) on page 669
  - ["To start signal generation"](#) on page 671
  - ["To compensate signal mis-alignment:"](#) on page 671

4. For DACW revision  $\geq 6$ , follow the instructions:
  - "To connect the instruments and route signals (R&S SMW-B9, DACW revision  $\geq 6$ )" on page 670
  - "To configure the primary and secondary instruments R&S SMW200A (R&S SMW-B9, DACW revision  $\geq 6$ )" on page 670
  - "To start signal generation" on page 671
  - "To compensate signal mis-alignment:" on page 671

### R&S SMW-B10

Proceed as follows:

- To connect the instruments and route signals
- To configure the primary instrument (R&S SMW200A)
- To configure the secondary instrument (R&S SMW200A)
- To compensate signal mis-alignment:

### To connect the instruments and route signals

1. With the default connector settings of the R&S SMW200A, connect the instruments in a daisy chain:

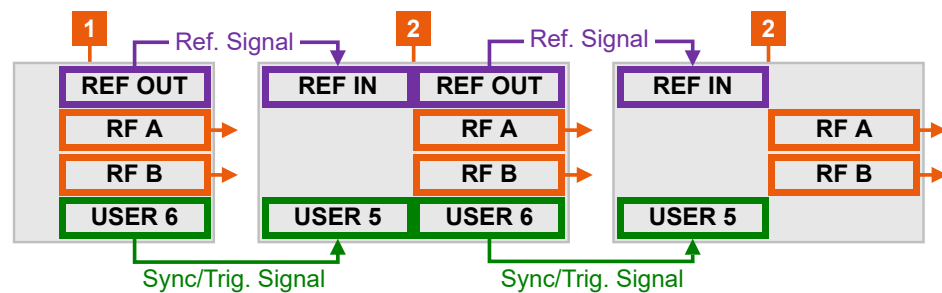

Figure 10-1: Example: Daisy chain connection for distributing the synchronization signal (simplified)\*

- \* = I/Q, LAN etc. connections are not shown
- 1 = Primary instrument acting as a synchronization and trigger signal source
- 2 = Secondary instruments: One or more cascaded instruments, receiving (and forwarding) the synchronization and trigger signal
- REF OUT, REF IN = Reference frequency connectors
- USER x = Synchronization and trigger signal connectors
- RF = RF signal output connector

- Connect **USER 6** connector of the primary instrument R&S SMW200A to **USER 5** connector of the first secondary instrument.
- Connect USER 6 connector of the first secondary instrument to the USER 5 connector of the second secondary instrument, etc.

**Note:** Avoid unnecessary cable length and branching points.

Use cables of the same length and type for all connections between the primary instrument and the secondary instruments and between secondary instruments.

2. To distribute the internal reference signal of one of the instruments (in this example the primary instrument), connect the instruments in a daisy chain **concerning the reference frequency**.

Connect REF OUT of the primary instrument R&S SMW200A to the REF IN of the first of the secondary instrument group, etc.

See [Section 8.8, "Reference oscillator"](#), on page 491.

#### To configure the primary instrument (R&S SMW200A)

1. Select "RF" > "Reference Frequency" > "Source" > "Internal".
2. Select "System Config" > "Multi Instruments".
3. Select "Multi Instrument Trigger" > "Primary".
4. Select "State" > "On".
5. In the "Global Connector Settings" dialog, and observe the current signal assignment.

Per default, the synchronization signal ("Baseband Sync Out") is output at the USER 6.

6. Configure the baseband signal as required for the particular test setup. Configure the trigger signal, for example, as follows:
  - a) Select "Baseband" > "EUTRA/LTE" > "Trigger In"
  - b) Select "Mode" > "Armed Retrigger" and "Source" > "Internal"
  - c) Set "Sync. Out to Trigger" > "On".

The trigger parameters of all basebands are coupled. Once the basebands are activated, they use a common trigger signal.

See also ["Starting the signal generation with the first sample"](#) on page 240.

#### To configure the secondary instrument (R&S SMW200A)

1. Select "RF" > "Reference Frequency" > "Source" > "External".  
Use the default reference frequency settings.
2. Select "System Config" > "Multi Instruments" > "Multi Instrument Trigger" > "Secondary".
3. Select "State" > "On".

4. Observe the current synchronization status.

The parameter indicates that the instruments are not synchronized.

Synchronization is achieved at the moment the basebands in the secondary instruments and in the primary instrument are activated.

5. Configure the baseband signal.
  - a) Select the same trigger mode as in the primary instrument.
  - b) Set "Sync. Out to Trigger" > "On".

c) Observe the automatic trigger source selection "Source" = "Baseband Sync In"

Once the baseband is activated, the secondary instruments are triggered by the synchronization signal.

If the secondary instrument is R&S SMW200A, the trigger parameters of all basebands are coupled and all basebands use a common trigger signal.

#### To connect the instruments and route signals (R&S SMW-B9, DACW revision $\geq$ 6)

- ▶ With the default connector settings of the R&S SMW200A, connect the instruments in a daisy chain:

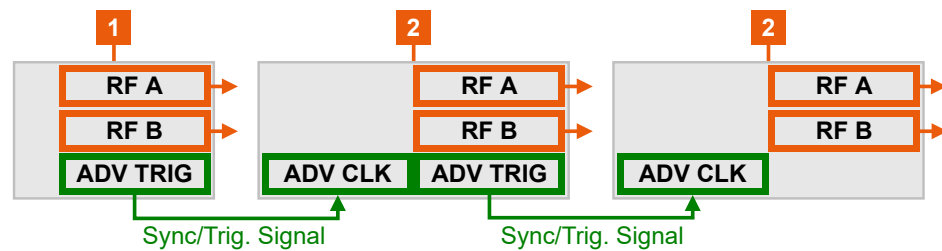

Figure 10-2: Example: Daisy chain connection for distributing the synchronization signal (simplified)\*

\* = I/Q, LAN etc. connections are not shown

1 = Primary instrument acting as a synchronization and trigger signal source

2 = Secondary instruments: One or more cascaded instruments, receiving (and forwarding) the synchronization and trigger signal

ADV TRG, ADV = Synchronization and trigger signal connectors

CLK

RF A/RF B = RF signal output connector

- Connect **ADV TRG** connector of the R&S SMW200A primary instrument to **ADV CLK** connector of the first of the secondary instrument group.
- Connect ADV TRG connector of the first of the secondary instrument group to the ADV CLK connector of the second of the secondary instrument group, etc.

**Note:** Avoid unnecessary cable length and branching points.

Use cables of the same length and type for all connections between the primary instrument and the secondary instruments and between secondary instruments.

#### To configure the primary and secondary instruments R&S SMW200A (R&S SMW-B9, DACW revision $\geq$ 6)

1. Select "System Config" > "Multi Instruments".
2. Select "Multi Instrument Trigger" > "Primary".
3. Select "State" > "On".
4. Configure the baseband signal as required for the particular test setup. Configure the trigger signal, for example, as follows:
  - a) Select "Baseband" > "EUTRA/LTE" > "Trigger In"
  - b) Select "Mode" > "Armed Retrigger" and "Source" > "Internal"
  - c) Set "Sync. Out to Trigger" > "On".

The trigger parameters of all basebands are coupled. Once the basebands are activated, they use common trigger signal.

See also "[Starting the signal generation with the first sample](#)" on page 240.

5. Select "Multi Instrument Trigger" > "Secondary".

6. Select "State" > "On".

7. Observe current synchronization status.

The parameter indicates that the instruments are not synchronized.

Synchronization is achieved at the moment the basebands in the secondary instruments and in the primary instrument are activated.

8. Configure the baseband signal.

- a) Select the same trigger mode as in the primary instrument.

- b) Set "Sync. Out to Trigger" > "On".

- c) Observe the automatic trigger source selection "Source" = "Baseband Sync In".

Once the baseband is activated, the secondary instruments are triggered by the synchronization signal.

If the secondary instrument is R&S SMW200A, the trigger parameters of all basebands are coupled and all basebands use common trigger signal.

#### To start signal generation

1. In the secondary instruments, start signal generation.

That is, activate the baseband generator.

2. In the primary instrument, activate the baseband generator.

3. In the secondary instruments, observe the value of the parameter "System Config" > "Multi Instruments" > "Synchronization State"

The instruments are synchronized if the following applies:

- The physical connection is established.
- The synchronization signal is routed properly.
- The baseband generators in all generators are active.

#### To compensate signal mis-alignment:

1. Connect an oscilloscope or network analyzer.

Observe the generated signals.

2. Compare the signal start in the instruments.

3. To compensate signal delay, select "I/Q Modulator" > "I/Q Digital Impairments".

4. Vary the value of the parameter "I/Q Delay" to achieve time aligned signals.

5. If the value range is insufficient, enable also or alternatively a trigger delay.

Select "Baseband" > "<Dig Standard>" > "Trigger In" > "Delay".

6. Vary the values until the signals align in time.

### 10.3.1.3 Further information

See:

- Trigger settings of the used baseband source, for example [Section 5.5.2.1, "Trigger settings"](#), on page 252.

See also [Section 12.2, "Configuring local and global connectors"](#), on page 742.

## 10.3.2 Connecting to HS DIG I/Q interfaces

In a multi-instrument setup, you can use the R&S SMW200A as a primary instrument and connect secondary instruments to the HS DIG I/Q connectors of the R&S SMW200A. For example, for performance testing, an nx4 MIMO configuration of an 5G NR signal in the frequency band above 6 GHz.

### To connect to the R&S SMW200A

1. Connect all connections between the R&S SMW200A and the external instruments as in the table below.

**Table 10-1: Signals and connections for R&S SMCV100B as secondary instruments**

Signal	R&S SMW200A	R&S SMCV100B 1	R&S SMCV100B 2
I/Q 1	HS DIG I/Q 1 ("BBMM 1")	Dig. IQ HS 1	-
I/Q 2	HS DIG I/Q 2 ("BBMM 2")	-	Dig. IQ HS 1
Sync/Trigger 1	ADV TRG	User 2	-
Sync/Trigger 2	ADV TRG	-	User 2
Reference 1	REF OUT	Ref In	
Reference 1	-	Ref Out	Ref In
Control	LAN	LAN	LAN



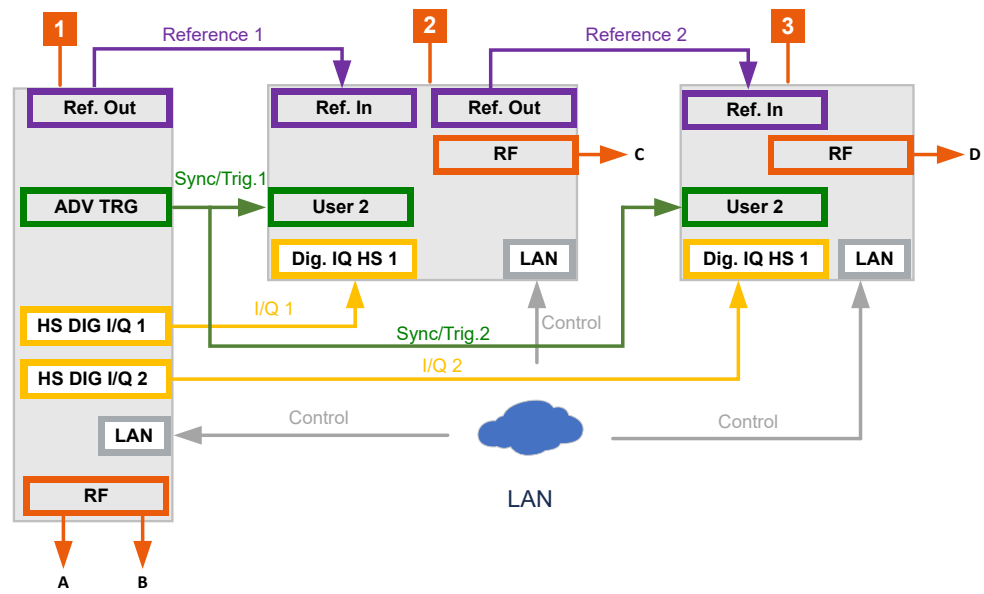

- 1 = R&S SMW200A (primary instrument)
- 2 = R&S SMCV100B 1 (secondary instrument)
- 3 = R&S SMCV100B 2 (secondary instrument)

**Table 10-2: Signals and connections for R&S SMW200A/ R&S SMM100A as secondary instruments**

Signal	R&S SMW200A	R&S SMW200A / R&S SMM100A 1	R&S SMW200A / R&S SMM100A 2
I/Q 1	HS DIG I/Q 1 ("BBMM 1")	HS DIG I/Q 1	-
I/Q 2	HS DIG I/Q 2 ("BBMM 2")	-	HS DIG I/Q 1
Sync/Trigger 1	ADV TRG	ADV CLK	-
Sync/Trigger 2	ADV TRG	-	ADV CLK
Reference 1	REF OUT	REF IN	-
Reference 2	-	REF OUT	REF IN
Control	LAN	LAN	LAN

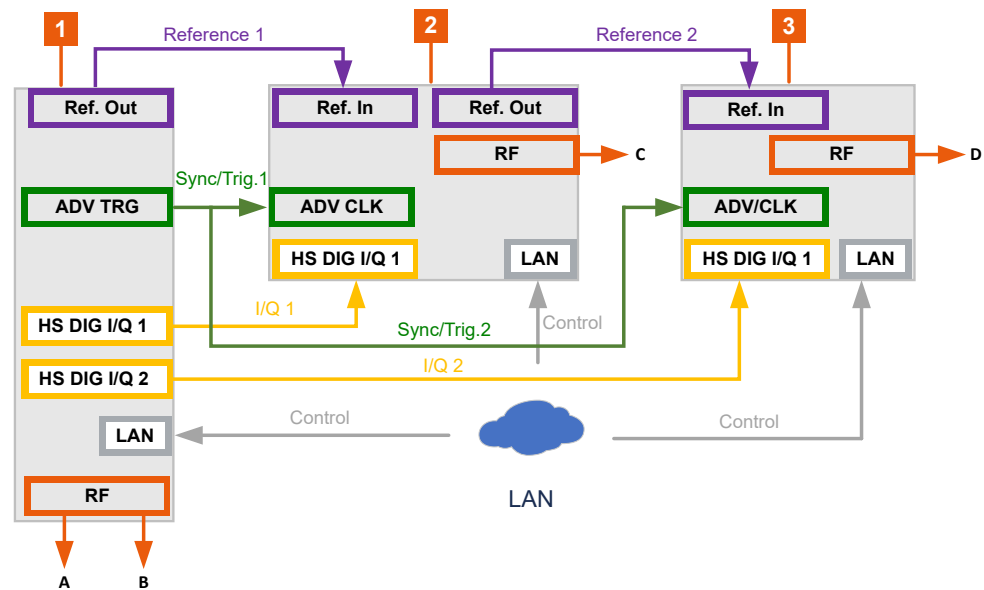

- 1 = R&S SMW200A (primary instrument)  
 2 = R&S SMW200A 1/R&S SMM100A 1 (secondary instrument)  
 3 = R&S SMW200A 2/R&S SMM100A 2 (secondary instrument)

**Note:** Avoid unnecessary cable length and branching points. Use cables of the same length and type for all connections between the primary instrument and the secondary instruments and between secondary instruments.

2. Connect the R&S SMW200A and the external instruments to the same LAN. See also ["To find out the correct connector"](#) on page 184.
3. Supply all instruments with a common frequency reference signal:
  - a) On the primary instrument R&S SMW200A, select "RF" > "Reference Frequency" > "Source" > "Internal".  
See [Section 8.8, "Reference oscillator"](#), on page 491.
  - b) On the secondary instruments, select "Reference Frequency" > "Source" > "External".  
For details on how to set the reference frequency of the secondary instrument, see the respective user manual.

### 10.3.2.1 Configuring the primary instrument

This chapter describes the configuration of the primary instrument exemplary for a setup with R&S SMCV100B as secondary instrument. When using other products as a secondary instrument, the configuration of the primary instrument is analogous.

#### To configure the R&S SMW200A as primary instrument

1. Select "System Config" > "System Configuration" > "Fading/Baseband Config":
  - a) Select "Mode" > "Advanced".
  - b) Select "Signal Outputs" > "Analog & Digital (HS)".

- c) Click "Apply".
2. Select "System Configuration" > "I/Q Stream Mapper".
3. In the "I/Q Stream Mapper" tab, route the I/Q streams to the output connectors:
  - "Stream A": "RF A"
  - "Stream B": "RF B"
  - "Stream C": "BBMM 1"
  - "Stream D": "BBMM 2"
4. Select "System Configuration" > "Multi Instrument".
5. Select "Common Trigger" > "Multi Instrument Trigger" > "Primary".
6. Select "State" > "On".

See also [Section 10.3.1, "Connecting multiple instruments in primary-secondary instrument mode"](#), on page 664 and [Section 10.3.1.1, "Multi-instrument settings"](#), on page 665.

#### To establish a connection to the secondary instrument

1. Select "System Configuration" > "External RF and I/Q".
  - a) Select "BBMM 1" > "External Instrument" > "Config".
  - b) Select "External Instrument" > "SMCV100B".
  - c) If the selection does not list your instrument, click "Scan".  
The scanning procedure checks the interface for connected external instruments.
  - d) Click "Apply and Connect".
  - e) Follow the same procedure for configuring the external instrument on "BBMM 2".
2. Check the status of the remote connection in the "Rem Conn" column.

Multi Instrument										
Fading/Baseband Config			I/Q Stream Mapper			External RF and I/Q		Overview		
Display		Mapped Connectors		Connect All Remote		Disconnect All Remote		Auto Connect <input type="checkbox"/>		
Preset behavior: Keep connections to external instruments <input type="checkbox"/>										
	Dir	External Instrument	I/Q Conn	Rem Conn	Instrument Name	RF Coup	RF Frequency (Hz)	RF Level (dBm)	RF State	
CODER 1	In	Config...								
CODER 2	In	Config...								
BBMM 1	Out	Config...			smcvb	<input checked="" type="checkbox"/>	Δ: 0.00	Δ: 0.00	On	
BBMM 2	Out	Config...								
I/Q OUT 1	Out	Config...			Single Ended					
I/Q OUT 2	Out	Config...			Single Ended					
RF A	Out	Config...								

### To configure the baseband trigger signal

Configure the baseband signal as required for the particular test setup, for example:

1. Select "Baseband" > "5G NR/Sidelink".
2. Configure the trigger signal:
  - a) Select "Trigger In" > "Mode" > "Armed Retrigger".
  - b) Select "Source" > "External Global Trigger 1".
  - c) Enable "Sync. Output To Ext. Trigger".

Synchronization couples the trigger parameters of all basebands. Once you enable baseband signal generation, these baseband signals use a common trigger signal.

### Enabling RF signal generation for all instruments

- ▶ To enable RF signal generation, select "RF" > "On".

Enabling the RF output of the primary instrument R&S SMW200A automatically enables the RF output of the secondary instruments R&S SMCV100B in the setup.

#### 10.3.2.2 Checking the secondary instrument

The primary instrument controls the secondary instruments. It configures the secondary instrument via a remote connection.

The following step-by-step instruction provides an exemplary setup with the R&S SMCV100B as a secondary instrument. For other secondary instrument, the configuration is analogous.

1. Check the block diagram of the secondary instrument after the primary instrument established the remote connection.

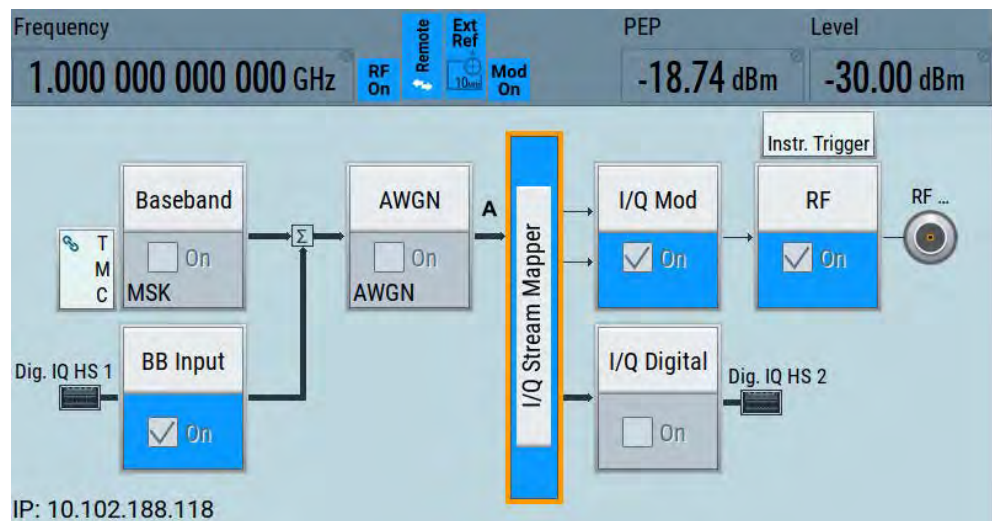

See "To establish a connection to the secondary instrument" on page 200.

2. Select "BB Input" > "Baseband Input Settings".

The secondary instrument displays connection settings and the connected primary instrument.

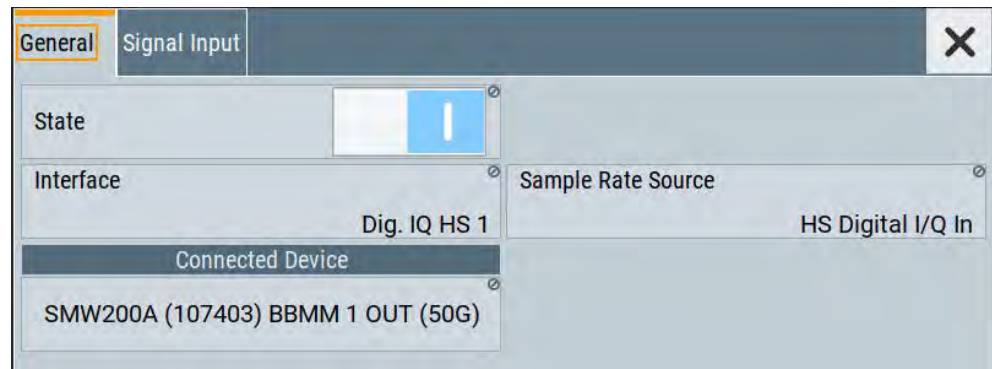

3. In the block diagram, select "System Configuration" > "Multi Instrument".

The secondary instrument displays an enabled multi-instrument state and its use as a secondary instrument.

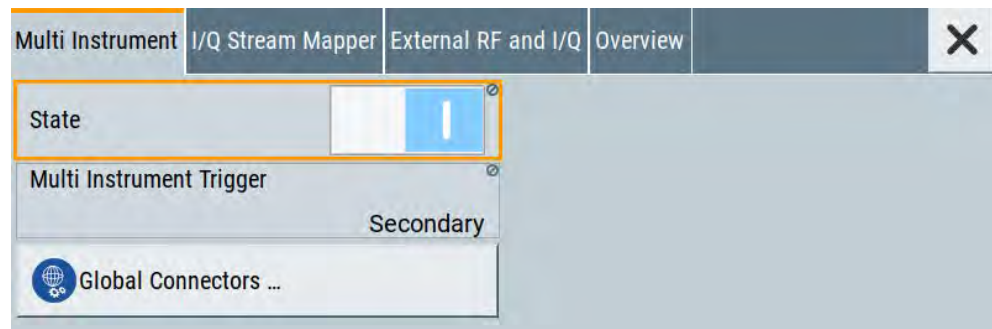

4. Select "System Configuration" > "External RF and I/Q".

The secondary instrument displays an enabled connection to the primary instrument via the QSFP+ interfaces.

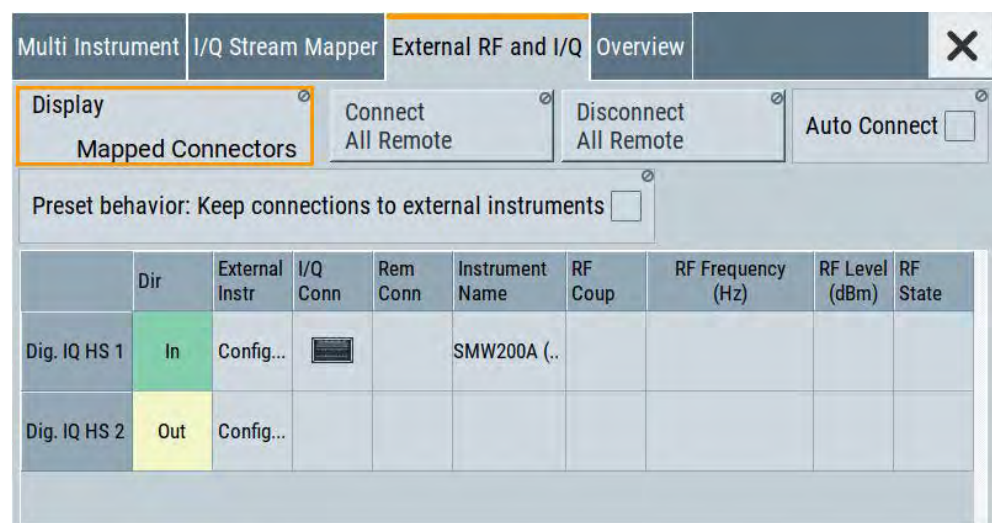

### 10.3.3 Triggering several instruments with a common trigger signal

The configuration described in this section is useful, in the following cases:

- R&S SMW200A is equipped with [Standard baseband generator](#)
- Or primary-secondary instrument mode is not used or possible

Using the same trigger event on several instruments is useful to synchronize the transmitted and received signals. Some test cases also require that you control the signal generation start and determine the exact generation start time by a defined trigger event. The signal generation start can be controlled, for example, by triggering the instrument internally or externally from the DUT.

To share common trigger signal:

- Let one R&S SMW200A generate a dedicated signal that triggers all R&S SMW200A instruments.  
See [Example "Triggering several R&S SMW200A instruments simultaneously"](#) on page 678.
- Connect all instruments to a common external trigger source.

See also [Section 3.3.4, "Working with marker signals"](#), on page 62.

#### Example: Triggering several R&S SMW200A instruments simultaneously

This example shows you how to connect several R&S SMW200A, distribute the trigger signal generated by the first one (R&S SMW200A#1) and trigger the instruments simultaneously.

Required cabling and connections:

- Connect the instruments in a star network, concerning the trigger signal. That is, connect the USER 6 output of the R&S SMW200A#1 to the USER 3 input of all other R&S SMW200A and the R&S SMW200A#1 itself.
- Always use cables of the same length. Use as short as possible cables.

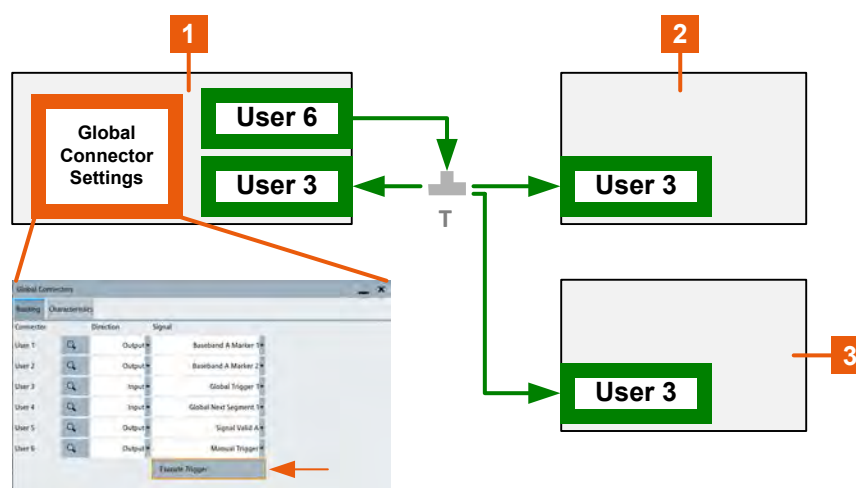

T = T-connector  
 1 = Trigger source (R&S SMW200A#1)  
 2, 3 = N number of instruments (R&S SMW200A#2 to R&S SMW200A#n)  
 USER x = Connectors  
 <- = Executes trigger manually

Required configurations:

- In all R&S SMW200A:
  - Use the default settings "User 3" > "Direction" = "Input" and "Signal" = "Global Trigger 1".
  - Select "Baseband" > "<Dig Standard>" > "Trigger In" > "Source" > "Ext. Global Trigger 1".
- In R&S SMW200A#1, set "System Config" > "Setup" > "Global Connectors" > "User 6" > "Direction" = "Output".  
 Set "User 6" > "Signal" = "Manual Trigger".

To trigger the signal generation from R&S SMW200A#1, select "Global Connectors" > "Execute Trigger".

Alternatively, send the remote control command `:OUTPut:USER<ch>:TRIGger[:IMMediate]`.

R&S SMW200A#1 generates a short high signal and outputs it at the USER connector. The signal acts as a common external trigger signal for all R&S SMW200A and all basebands.

## 10.4 Generating phase-coherent signals

Option: R&S SMW-B9 and R&S SMW-K545

Test setups often comprise several instruments, like, for example, multiple Rohde & Schwarz signal generators that generate RF signals.

If your test setup requires **coherent RF signals that are aligned concerning time, phase and power level**, you can use R&S NRP power sensors to calibrate the absolute power levels. You can also follow the instructions listed in the other sections of this chapter or use the possibility of option R&S SMW-K544 to compensate for all effects. However, calibrating the phase difference, time delay difference and amplitude difference between the channels at the RF carrier is a troublesome and time-consuming task.

You can use the R&S®RFPAL software to collect required correction data and calibrate the setup. For interplay with R&S®RFPAL and for applying the correction data afterwards, the option R&S SMW-K545 is required on the signal generators. When applying correction data at the signal generators during signal generation, the resulting RF signals are coherent and aligned in terms of power level, phase difference and the time delay.

R&S®RFPAL is documented separately, see the document "R&S®SMW-K545 RF Ports Alignment User Manual".

### 10.4.1 Required options

- R&S SMW-K545 (on each signal generator): RF ports alignment
- R&S SMW-K544 (per signal path): User-defined frequency response correction
- R&S SMW-K61 (per signal path): Multi-carrier continuous wave
- R&S SMW-B9 (per signal path): Wideband baseband generator
- R&S SMW-B13XT: Wideband baseband main module two I/Q paths to RF
- R&S SMW-B90: Phase coherence
- R&S SMW-B1003 (for example): RF frequency from 100 kHz to 3 GHz

If only standard baseband signals are required, you can use R&S SMW-B10 and R&S SMW-B13T instead of R&S SMW-B9 and R&S SMW-B13XT.

For more information, refer to the specifications document.

### 10.4.2 RF ports alignment configuration and settings

Access:

1. Select "System Configuration > Multi Instrument > RF Ports Alignment".
2. To load a setup, click "Setup".  
The dialog to select a setup file opens.
3. Select a setup file, e.g. "Predefined Files" > "demo".

The selected setup is loaded. The test setup is schematically displayed and you have access to the setup settings.

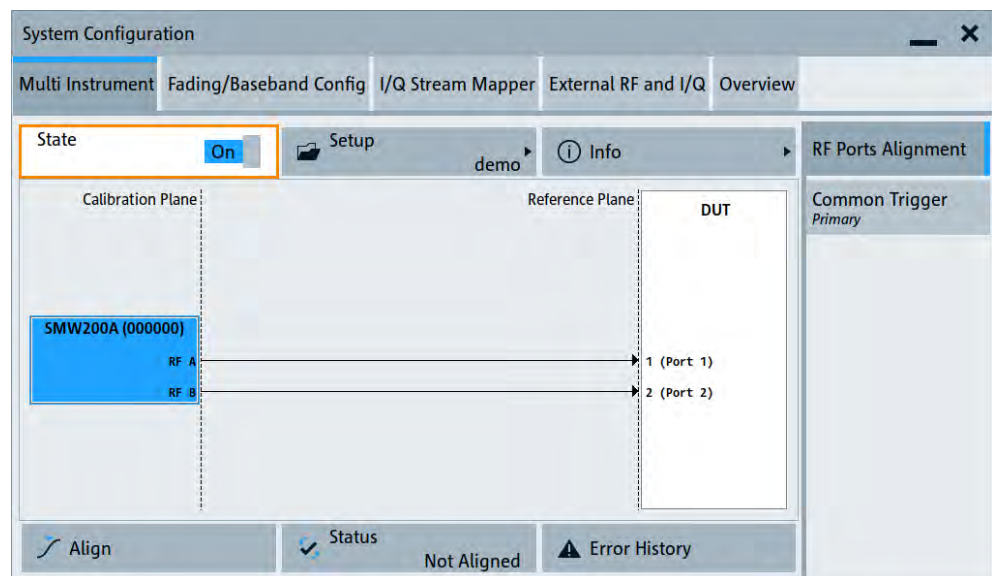

The remote commands required to define these settings are described in [Section 14.18.5, "RF ports alignment commands"](#), on page 996.



**Settings:**

- [General settings](#).....681
- [RF ports setup info](#).....684
- [RF ports setup file settings](#).....692
- [Additional S-Parameter files settings](#).....694

**10.4.2.1 General settings**

This dialog displays the test setup schematically and provides access to the setup settings.

<a href="#">State</a> .....	681
<a href="#">Setup</a> .....	682
<a href="#">Info</a> .....	682
<a href="#">Test Setup</a> .....	682
<a href="#">Align</a> .....	683
<a href="#">Status</a> .....	683
<a href="#">Error History</a> .....	684

**State**

Activates the RF ports alignment function. Setup files with correction data are transferred to the secondary instruments. The following configurations are automatically set. Correction data is applied during signal generation using these configurations.

- "RF":
  - "Attenuator > Mode = Auto"
  - "ALC > Mode = Off (Table)" and "ALC > Driver Amplifier = Auto"
  - "UCOR > State = Off"
  - "LO Coupling > Mode" = "Internal" or "A Internal & A->B Coupled"
  - "LO Coupling > Out State = B On"; otherwise "Out State = Off"
- "I/Q Mod > Frequency Response":
  - "General > Optimization Mode = High Quality Table"
  - "General > Optimization Bandwidth = Auto"
  - "User Defined Corrections > State = On"
- "System Configuration > Multi Instrument > Common Trigger":
  - "State = On"
  - "Multi Instrument Trigger = Primary" on the primary instrument,  
"Multi Instrument Trigger = Secondary" on the secondary instruments
- "System Configuration > Multi Instrument > RF Ports Alignment > RF Ports Setup Info":
  - "Calibration > LO Coupling = Active"
  - "Setup Overview > REF Configuration > Signal Source" = "Primary" or "External"
  - "Setup Overview > LO Configuration > Signal Source" = "Primary" or "External"
  - "Setup Overview > Wiring Constellation" = "Daisy Chain" or "Star"

Remote command:

[:SCONfiguration:RFALignment:STATE](#) on page 1000

### Setup

Accesses the "Setup File" dialog, that is the standard instrument function for saving and loading setup files. The provided navigation possibilities in the dialog are self-explanatory.

The filename and the directory in which the settings are saved are user-definable; the file extension is predefined.

The setup file (\*.rf<sub>sa</sub>) is an archive file containing setup description file (\*.xml), the RF port correction files (\*.rf<sub>cor</sub>), the frequency response correction files (\*.rf<sub>resp</sub>) and the S-parameter files (\*.sn<sub>p</sub>). It is **created automatically** during calibration by RFPAL and can be **loaded only in the primary instrument**. Do not create or modify setup files manually.

On recall, the instrument checks if the current instrument is the reference instrument used during calibration with RFPAL. The dialog also displays the wiring diagram of the selected setup. If the setup file is loaded in a different instrument, a setting conflict appears.

The setup files in the secondary instruments are distributed by the primary instrument and loaded in the secondaries automatically.

Remote command:

[:SCONfiguration:RFAlignment:SETup:PREDefined:CATalog?](#) on page 998

[:SCONfiguration:RFAlignment:SETup:FILE:PREDefined](#) on page 998

[:SCONfiguration:RFAlignment:SETup:CATalog?](#) on page 999

[:SCONfiguration:RFAlignment:SETup:FILE](#) on page 999

### Info

Accesses the "RF Ports Setup Info" dialog that displays summary information on the configured settings, see [Section 10.4.2.2, "RF ports setup info"](#), on page 684.

### Test Setup

Displays the cabling diagram fo the current setup.

The diagram is interactive. Click an element to access further settings.

Indicated are:

Primary instrument

The primary instrument, incl. alias name, serial number and number of RF outputs.

The primary instrument is the uppermost instrument displayed in dark blue color. Click the block to open a dialog with its "Hostname / IP Address" and for quick access to the [RF Port Setup File Editor](#) dialog ("Edit Setup").

**Secondary instrument(s)**

The secondary instruments, incl. their remote connection status, alias name, serial number and number of RF outputs.

Click the block to open a dialog with information on the "Hostname / IP Address", "Remote Status" and for quick access to the [RF Port Setup File Editor](#) dialog ("Edit Setup").

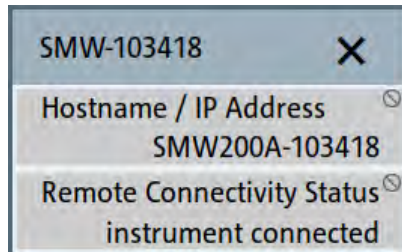

Figure 10-3: Secondary instrument dialog

**S-parameter files**

Indicates if and how many S-parameter files are loaded.

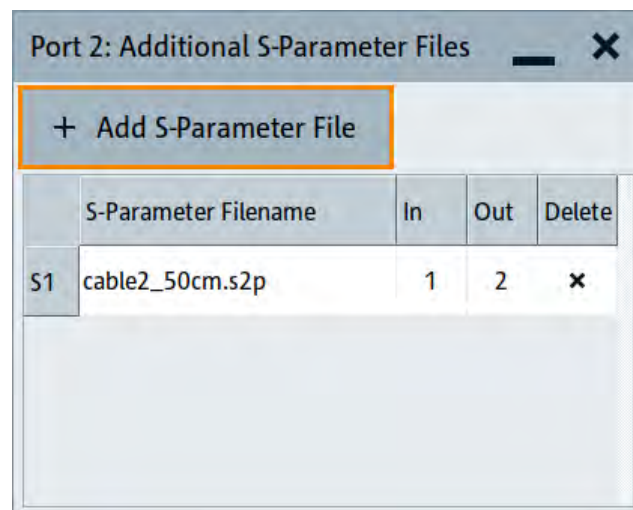

Figure 10-4: Additional S-Parameter Files dialog

**DUT**

DUT, incl. the RF ports designation, as configured in the [RF Port Setup File Editor](#) dialog.

**Align**

Sends the multi-instrument trigger signal to all instruments to synchronize the base-bands of the instruments if a valid setup is loaded ("RF Ports Alignment > Setup") and the "RF Ports Alignment > State" is "On".

Remote command:

`:SCONfiguration:RFALignment:ALIGn` on page 1000

**Status**

Retrieves and displays information on the internal compensation status and the connected secondary instruments.

"No Setup"	A setup file has not been loaded.
"Invalid Setup"	<p>Possible causes:</p> <ul style="list-style-type: none"> <li>• The loaded setup file has been removed.</li> <li>• The setup file is invalid (RF ports are not configured).</li> <li>• Mismatch between the setup and the physical instrument (the setup is loaded in an instrument that is not the primary instrument).</li> </ul>
"Not Active"	The setup file is loaded but "RF Ports Alignment > State = Off".
"Not Aligned"	<p>Indicates one of the following situations:</p> <ul style="list-style-type: none"> <li>• Setup is loaded and "RF Ports Alignment &gt; State = On", system is not triggered Execute "Align" to send the multi-instrument trigger signal to all instruments to synchronize the basebands of the instruments.</li> <li>• Setup is loaded and active but frequency value is changed (in primary or in the secondary instrument). The instrument with changed frequency value waits for trigger event.</li> </ul>
"Aligned"	The setup is aligned and ready for operation.
"Error"	Settings conflict or missing connection to secondary instruments.
"Warning"	<p>Indicates the following situations:</p> <ul style="list-style-type: none"> <li>• Selected frequency or PEP value outside of the calibrated range.</li> <li>• Temperature deviation (<a href="#">Temperature Offset to Last Calibration</a> is greater than +/- 3K)</li> <li>• Internal adjustment was performed since last calibration.</li> <li>• "LO Coupling = On" but the secondary instrument cannot be synchronized.</li> </ul>

A warning icon in the task bar indicates the erroneous situation.

Remote command:

[:SCONfiguration:RFAlignment:SETup:STATus?](#) on page 999

### Error History

Indicates the status of the alignment process.

#### 10.4.2.2 RF ports setup info

Access:

1. Select "System Configuration > Multi Instrument > RF Ports Alignment".
2. Select "Setup > User files > <... .rfsa > > Select".
3. Select "RF Ports Alignment" > **"Info"**.

• <a href="#">Calibration settings</a> .....	685
• <a href="#">Current corrections settings</a> .....	688
• <a href="#">Setup overview</a> .....	690

## Calibration settings

Access:

- ▶ Select "RF Ports Alignment > Info" > "**Calibration**".

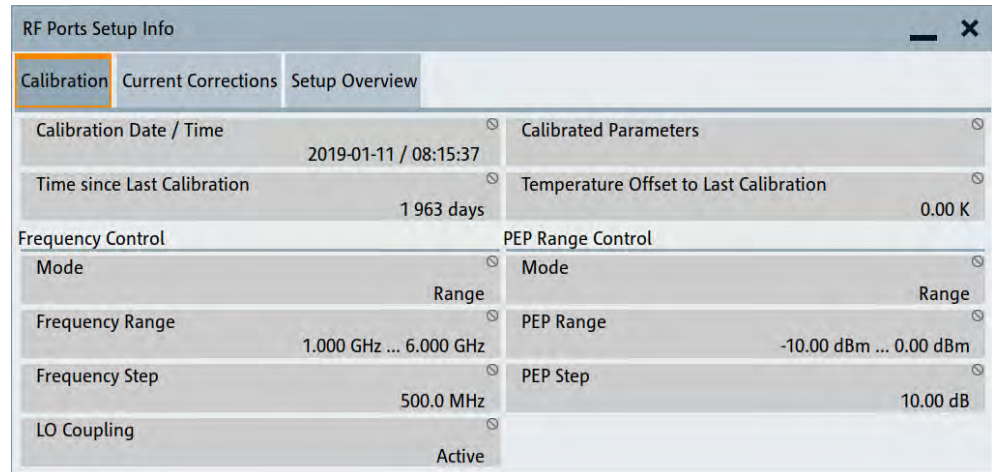

Figure 10-5: RF Ports Setup Info > Calibration

This dialog displays summary information on the calibration data as retrieved from the setup file.

### Settings:

Calibration Date/Time.....	685
Calibrated Parameters.....	685
Time since Last Calibration.....	686
Temperature Offset to Last Calibration.....	686
Frequency/PEP Control.....	686
L Mode.....	686
L Frequency Range/PEP Range.....	686
L Frequency Step/PEP Step.....	687
L Frequency Values/PEP Values.....	687
L LO Coupling.....	687

### Calibration Date/Time

Indicates the date and time the calibration described in the loaded setup file is performed.

Remote command:

`:SCONfiguration:RFAlignment:SETup:INFO:CALibration:DATE?`

on page 1000

`:SCONfiguration:RFAlignment:SETup:INFO:CALibration:TIME?`

on page 1001

### Calibrated Parameters

Summary information on the major calibrated parameters.

Remote command:

`:SCONfiguration:RFALignment:SETup:INFO:CALibration:PARAMeters?`  
on page 1001

#### Time since Last Calibration

Indicates the elapsed time since the moment the calibration described in the loaded setup file is performed.

Remote command:

`:SCONfiguration:RFALignment:SETup:INFO:CALibration:AGE?`  
on page 1001

#### Temperature Offset to Last Calibration

Indicates the difference in temperature since the moment the calibration described in the loaded setup file is performed.

The indication is color coded; if the temperature deviation exceeds +/- 3K, the value is displayed in red.

Remote command:

`:SCONfiguration:RFALignment:SETup:INFO:CALibration:TEMPerature:OFFSet?` on page 1001

#### Frequency/PEP Control

Comprises the frequency and PEP-related settings.

The displayed values resemble the values you have set during the calibration process.

#### Mode ← Frequency/PEP Control

Indicates the method used to define the calibrated frequency and PEP ranges.

- |         |  |
|---------|--|
| "Range" | By the min and max values of the range.  |
| "List"  | As a sequence of discrete frequency values.<br>See <a href="#">Frequency Values/PEP Values</a> .<br>Consider that greater number of calibration points leads to longer calibration time. |

Remote command:

`:SCONfiguration:RFALignment:SETup:INFO:CALibration:FREQUENCY:MODE?` on page 1002  
`:SCONfiguration:RFALignment:SETup:INFO:CALibration:POWER:MODE?`  
on page 1002

#### Frequency Range/PEP Range ← Frequency/PEP Control

Indicates the frequency and PEP ranges the calibrated values apply for.

This value is displayed if "Mode = Range" is used during the calibration, where the range is defined by the min and max values.

Remote command:

`:SCONfiguration:RFALignment:SETup:INFO:CALibration:FREQUENCY:RANGE:LOWer?` on page 1003  
`:SCONfiguration:RFALignment:SETup:INFO:CALibration:FREQUENCY:RANGE:UPPer?` on page 1003

`:SCONfiguration:RFALignment:SETup:INFO:CALibration:POWer:RANGe:LOWer?` on page 1003

`:SCONfiguration:RFALignment:SETup:INFO:CALibration:POWer:RANGe:UPPer?` on page 1003

#### **Frequency Step/PEP Step ← Frequency/PEP Control**

This value is displayed if "Mode = Range" is used during the calibration. It indicates the frequency/PEP step size that is used to define the frequency and level values to be calibrated with the range, defined with the min and max values.

Remote command:

`:SCONfiguration:RFALignment:SETup:INFO:CALibration:FREQuency:STEP?` on page 1003

`:SCONfiguration:RFALignment:SETup:INFO:CALibration:POWer:STEP?` on page 1003

#### **Frequency Values/PEP Values ← Frequency/PEP Control**

This value is displayed if "Mode = List" is used during the calibration.

It indicates the calibrated values, that are defined as a sequence of comma-separated discrete values in the required units.

Remote command:

`:SCONfiguration:RFALignment:SETup:INFO:CALibration:FREQuency:LIST:VALues?` on page 1002

`:SCONfiguration:RFALignment:SETup:INFO:CALibration:POWer:LIST:VALues?` on page 1002

#### **LO Coupling ← Frequency/PEP Control**

Indicates whether the instruments use a common local oscillator (LO) signal or not.

"Active"

All instruments are connected to the same LO reference frequency.

"Inactive"

Each instrument uses its own local oscillator.

Remote command:

`:SCONfiguration:RFALignment:SETup:INFO:CALibration:LOCoupling?` on page 1004

### Current corrections settings

Access:

- ▶ Select "RF Ports Alignment > Info" > "Current Corrections".

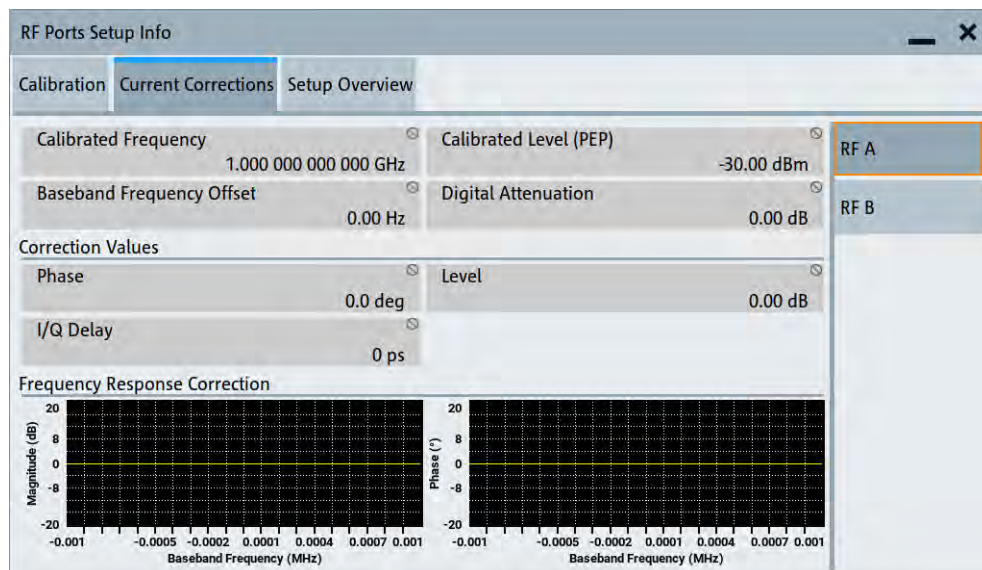

Figure 10-6: RF Ports Setup Info > Current Corrections

This dialog displays summary information on the current correction values per RF path.

#### Settings:

Calibrated Frequency.....	688
Calibrated Level (PEP).....	688
Baseband Frequency Offset.....	689
Digital Attenuation.....	689
Correction Values.....	689
L Phase.....	689
L Level.....	689
L I/Q Delay.....	689
Frequency Response Correction.....	689

#### Calibrated Frequency

Indicates the frequency  $f_{Cal}$  the calibration data is valid for.

This is the value you have set as RF frequency during the calibration process.

Remote command:

`:SOURCE on page 1285`

#### Calibrated Level (PEP)

Indicates the level  $P_{Cal}$  the calibration data is valid for.



Remote command:

`:SOURce<hw>:RFALignment:CALibrated:POWer:PEP?` on page 1285

### Baseband Frequency Offset

Indicates the applied baseband frequency offset  $f_{\text{BB Offset}}$ , calculated as the difference between the current frequency  $f_{\text{RF Out}}$  ("Status bar > Freq") and the calibrated frequency  $f_{\text{Cal}}$  ("Calibrated Frequency").

Remote command:

`:SOURce<hw>:RFALignment:FOFFset?` on page 1286

### Digital Attenuation

Indicates the applied digital attenuation  $P_{\text{Dig Att}}$ , calculated as the difference between the current level  $P_{\text{RF Out}}$  ("Status bar > Level") and the calibrated level  $P_{\text{Cal}}$  ("Calibrated Level").

Remote command:

`:SOURce<hw>:RFALignment:DATTenuation?` on page 1286

### Correction Values

Displays the correction values retrieved from the S-parameter files and used for compensation of the complex frequency response of the signal.

#### Phase ← Correction Values

Indicates the delta phase applied for compensation of the frequency response of the signal.

The value is retrieved from the S-parameter files.

Remote command:

`:SOURce<hw>:RFALignment:CORRection:PHASe?` on page 1286

#### Level ← Correction Values

Indicates the level correction applied to the signal of the selected path.

A level correction is required if a mismatch between the PEP values in the paths are detected.

The value is retrieved from the S-parameter files.

Remote command:

`:SOURce<hw>:RFALignment:CORRection:LEVel?` on page 1286

#### I/Q Delay ← Correction Values

Indicates the I/Q delay applied for compensation of the frequency response of the signal.

The value is retrieved from the S-parameter files.

Remote command:

`:SOURce<hw>:RFALignment:CORRection:IQDelay?` on page 1287

### Frequency Response Correction

Graphical representation of magnitude and phase variations of the currently used compensation filter over the available baseband bandwidth.

**Setup overview**

Access:

- ▶ Select "RF Ports Alignment > Info" > "Setup Overview".

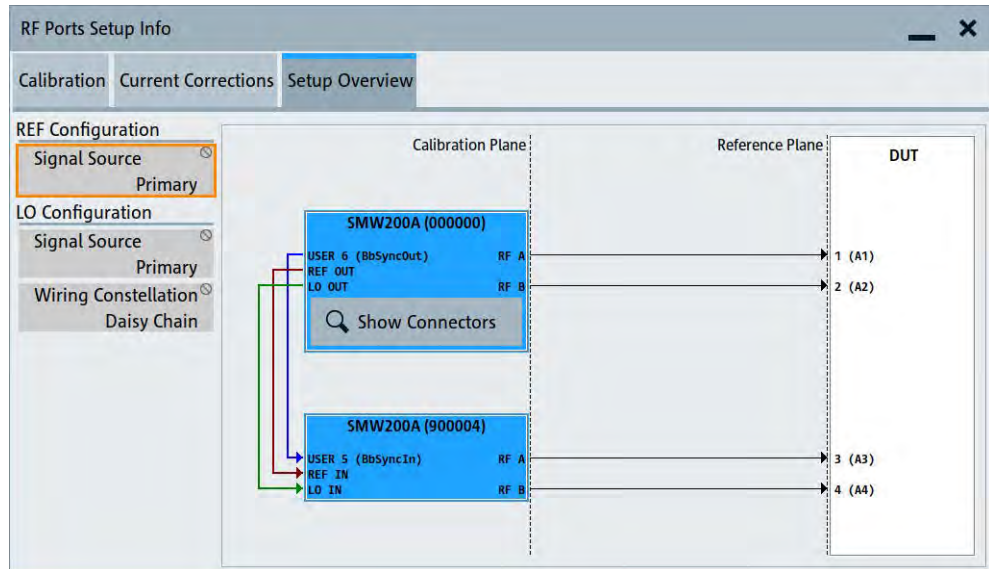

This dialog displays the wiring diagram of the setup. The displayed information resembles the setup displayed in the "RF Ports Alignment" dialog. See "Test Setup" on page 682.

Ref Configuration > Signal Source.....690  
 LO Configuration > Signal Source.....690  
 LO Configuration > Wiring Constellation..... 691  
 Test Setup..... 691

**Ref Configuration > Signal Source**

Indicates if the current instrument uses its own or an external reference signal.

"Primary" The instrument uses its reference signal and provides it to the other instruments.

"External" The instrument uses an external reference frequency source, for example from other R&S SMW200A (the one with "Ref Configuration" > "Signal Source = Primary") or from R&S®SMA100B.

Remote command:

```
:SCONfiguration:RFAlignment:SETup:INFO:WIRing:REF:SOURce?
```

on page 1005

**LO Configuration > Signal Source**

Indicates if the current instrument uses its own or an external LO signal.

**"Intern (Primary Instrument)"**

The instrument uses its own LO frequency.

In a two-path instruments, the LOs of the two signal paths are coupled, where the LO signal of the first path is fed to the LO of the second one.

The block diagram indicates this connection, too.

**"External Instrument"**

The instrument acts as a secondary one regarding the LO frequency. It receives the LO frequency from the instrument that acts as an LO source in the setup.

The external LO signal is fed at the first signal path.

In a two-path instruments, the LOs of the two signal paths are coupled, where the LO signal of the first path is fed to the LO of the second one.

The block diagram indicates this connection, too.

Remote command:

`:SCONfiguration:RFALignment:SETup:INFO:WIRing:LO:SOURce?`

on page 1004

**LO Configuration > Wiring Constellation**

Indicates the connection method used to distribute the LO frequency signal.

**"Daisy Chain"** A connection scheme in which instruments are connected together in sequence, i.e. an output of the first one is connected to an input of the second one, etc.

**"Star"** A connection scheme for several instruments that consists of one primary instrument and several secondary instruments, all connected to the primary one.

The LO signal of the primary instrument or from an external LO source is split with a power combiner or splitter and fed to the secondary instruments.

Remote command:

`:SCONfiguration:RFALignment:SETup:INFO:WIRing:LO:CONStellation?`

on page 1004

**Test Setup**

Displays the cabling diagram for the current setup.

The diagram is interactive. Click an element to access further settings.

Indicated are:

**Primary instrument**

The primary instrument, incl. alias name, serial number and number of RF outputs.

The primary instrument is the uppermost instrument displayed in dark blue color. Click the block to open a dialog with its "Hostname / IP Address" and for quick access to the [RF Port Setup File Editor](#) dialog ("Edit Setup").

## Secondary instrument(s)

The secondary instruments, incl. their remote connection status, alias name, serial number and number of RF outputs.

Click the block to open a dialog with information on the "Hostname / IP Address", "Remote Status" and for quick access to the [RF Port Setup File Editor](#) dialog ("Edit Setup").

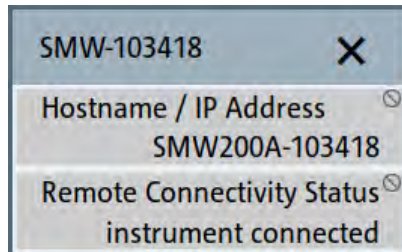

Figure 10-7: Secondary instrument dialog

## S-parameter files

Indicates if and how many S-parameter files are loaded.

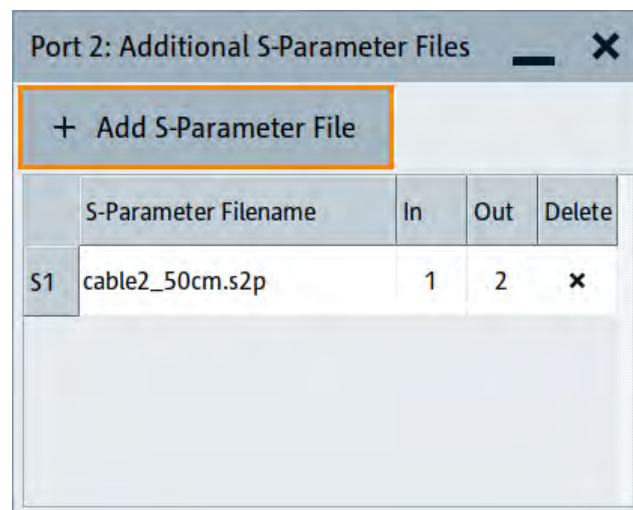

Figure 10-8: Additional S-Parameter Files dialog

## DUT

DUT, incl. the RF ports designation, as configured in the [RF Port Setup File Editor](#) dialog.

### 10.4.2.3 RF ports setup file settings

Access:

1. Select "System Configuration > Multi Instrument > RF Ports Alignment" > **"Setup"**.
2. Select a setup file and select "Edit".

The setup file (\*.rfsa) is an archive file containing setup description file (\*.xml), the RF port correction files (\*.rfcor), the frequency response correction files (\*.rfresp) and the S-parameter files (\*.snp). Setup files are created automatically during the calibration process.

Do not create or edit setup files manually.

The "RF Ports Setup File Editor" dialog opens.

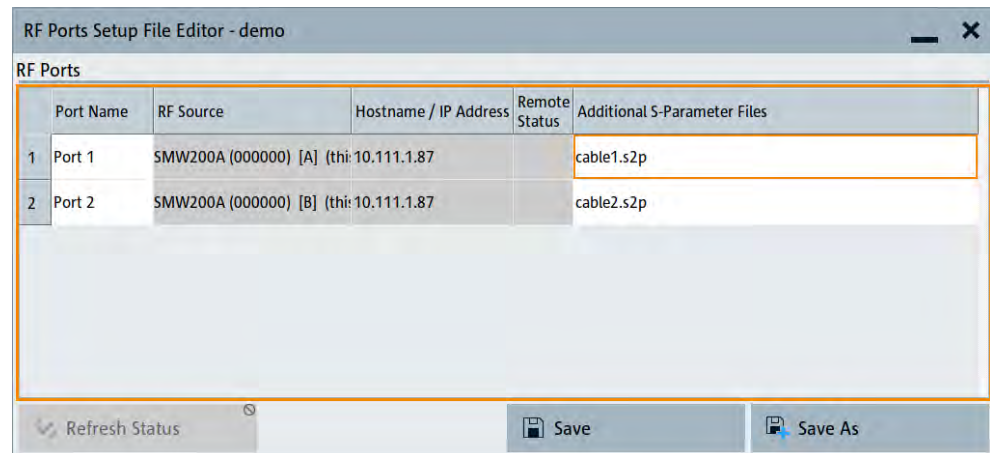

Figure 10-9: RF Ports Setup File Editor

The dialog displays an overview information on the following:

- Configured ports including user-defined port names
- The physical instruments on that the ports are located
- The filename of the files with calibration data
- If S-Parameter files are used during the calibration or loaded afterwards, the filenames of these files.

The "RF Ports Setup File Editor" dialog is the central point to reconfigure and control your setup. Here, you can rename ports, add, remove or exchange S-parameter files, retrieve information on connected external instruments, and save your settings in a loadable setup file.

RF port table.....	693
L Port Name.....	693
L RF Source.....	694
L Hostname / IP Address.....	694
L Remote Status.....	694
L Additional S-Parameters Files.....	694
Save Setup .../Save Setup as .....	694

### RF port table

Represents the RF ports configuration; there is one table row per RF port.

#### Port Name ← RF port table

Add an alias name for the RF port.

**RF Source ← RF port table**



Indicates the physical instrument which the RF port belongs to.

**Hostname / IP Address ← RF port table**

Displays/sets the IP address or hostname of the connected external instrument.

**Remote Status ← RF port table**

Indicates the remote connection status.

-  The RF port belongs to a secondary instrument; the remote connection to the secondary instrument can be established. The remote connection is active during the time the correction files are transferred to the secondary instruments. The term **secondary** instrument describes a signal generator connected in a primary-secondary mode and receiving the multi-instrument trigger from the primary instrument (see "System Configuration > Multi Instrument > Common Trigger > Multi Instrument Trigger = Secondary")
-  and yellow background At least one of the secondary instruments cannot be reached, that is the remote connection to it cannot be established. Check the "Hostname / IP Address" of the secondary instrument and select "Refresh" to check the status.

**Additional S-Parameters Files ← RF port table**

Indicates the filename of the S-Parameter files used during the calibration process or the S-Parameter files loaded subsequently.

During calibration, you may load S-Parameter files which describe the cables between the signal generator and the network analyzer. In this case, the correction data for the setup is calculated so that it excludes the correction values listed in the S-Parameter files. This allows you to exchange the S-Parameter files subsequently if you, for example, use different cables to connect the DUT to the outputs of the signal generator.

Click the filename to retrieve details on the loaded files or to select a different file, see [Section 10.4.2.4, "Additional S-Parameter files settings"](#), on page 694.

**Save Setup .../Save Setup as ...**

Saves the setup configuration in a file.

The "\*" symbol behind the filename in the dialog header indicates unsaved settings. It appears whenever you change any of the settings in the dialog.

To overwrite the current file, select "Save Setup ...".

To retain the setup file content, select "Save Setup as ...".

**10.4.2.4 Additional S-Parameter files settings**

Access:

1. Select "System Configuration > Multi Instrument > RF Ports Alignment" > **"Setup"**.
2. Select a setup file and select "Edit".

3. Select "RF Ports / Instruments > RF ports table" > "**Additional S-Parameter Files**".

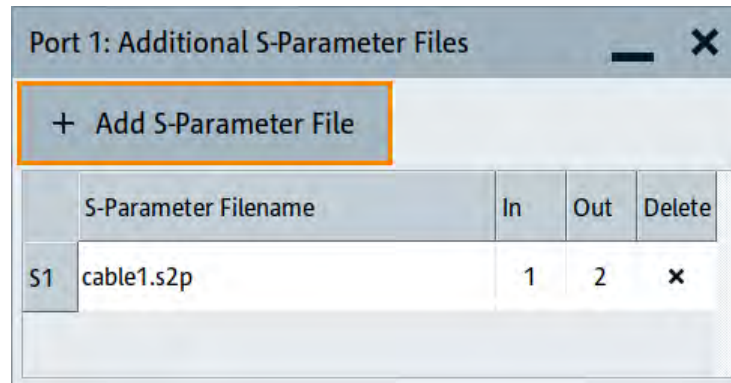

In this dialog, you can load S-parameter files to compensate for exchanged cables or other components.

#### Settings:

<a href="#">Add S-Parameter File</a> .....	695
<a href="#">S-Parameter Filename</a> .....	695
<a href="#">In/Out</a> .....	695
<a href="#">Delete</a> .....	695

#### Add S-Parameter File

Appends a row in the table with S-parameter files.

#### S-Parameter Filename

Indicates the filename of the loaded file.

Select the file to open the standard "File Select" dialog for selecting and loading S-parameters (Touchstone) files. S-parameters files are files with predefined extension (\* .s<n>p) and file format.

Use the standard "File Manager" function to transfer external data lists to the instrument.

#### In/Out

Sets the origin and destination ports, i.e. the port number from that the signal is coming and the port to that it is going. Use this parameter to change the orientation of the signal chain.

#### Delete

Removes the selected table row and the S-parameter file.

## 10.5 Control and operation of external instruments

In test scenarios that require more than two RF signals, the I/Q analog and digital output signal can be routed to and processed by external instruments. Typically, the generated I/Q streams are further processed by R&S SGT or R&S SGS.

Other applications like the radar echo generation or the generation of WLAN 802.11ad signals at 58.3 GHz require connected R&S FSW or R&S SZU.

The R&S SMW200A provides all settings required to configure the output connectors, to establish the connections to the connected RF instruments and to control them. The settings are grouped in the "System configuration" > [External RF and I/Q](#) dialog. In this dialog, you find an overview of all available I/Q input and output connectors and configure the connection to the external instruments.

Once the connection is established, the R&S SMW200A acts as a primary instrument and controls the setup-related parameters of any connected further processing external instrument.

### 10.5.1 Prerequisites for control of external instruments from the R&S SMW200A

Required are the following connections between the R&S SMW200A and the external instruments:

- Physical remote control connection over LAN or USB  
The remote control connection to the external instruments must be in status connected.  
See [Section 4.4.3, "External RF and I/Q settings"](#), on page 129.
- Physical signal connection for the digital or analog I/Q signal
- For the most test setups, the instruments must use a common reference frequency signal.

Suitable reference frequency signal sources are:

- An external common reference source
- The distributed reference frequency of the R&S SMW200A.

### 10.5.2 Test setups

The test setup depends on the external instrument and the used I/Q output signal (digital, analog single-ended or analog differential).

See for example [Figure 4-22](#), [Figure 4-24](#), [Figure 4-26](#) and [Figure 4-32](#).

See also [Section 4.1.2, "Test scenario and required system configuration"](#), on page 102.



### 10.5.3 Control of connected R&S SGT

Up to 6 R&S SGT instruments can be connected to the R&S SMW200A. As with all external instruments, you find R&S SGT-related information like the connection status and the used RF level and frequency values in the [External RF and I/Q](#) dialog. This dialog provides also additional short information on each of the connected instruments.

Settings related to the output signal are grouped in the [I/Q Digital](#) dialog.

### 10.5.4 Control of connected R&S SZU

If you connect an R&S SZU to the R&S SMW200A, the R&S SMW200A block diagram changes and resembles the signal routing. The R&S SMW200A routes the analog I/Q output signal into the R&S SZU. The I/Q modulator block visualizes the I/Q modulator of the R&S SZU. The routing is fixed. You can only swap the streams (A and B) at the RF outputs of use the differential I/Q outputs instead of the default single-ended output.

See also ["To connect and configure an R&S SZU"](#) on page 195.

The R&S SMW200A controls the R&S SZU as it is its embedded unit. You access the R&S SZU settings directly from the R&S SMW200A block diagram. The access is identical to the access of the R&S SMW200A RF settings but the list shows only the supported settings.

For example:

- To access the R&S SZU RF settings, select the R&S SZU icon.
- To access the I/Q modulator settings of the R&S SZU, select the "I/Q Mod" block.

The R&S SMW200A RF settings are dedicated to the R&S SZU. The corresponding RF output cannot be used for other application, like, for example, LO coupling.

As with other downstream instruments, the frequency and level indications in the R&S SMW200A status bar show the R&S SZU values. Parameters like the frequency and level offset, level limits, delta phase or RF output state affect the RF output of the R&S SZU.

The remote commands required to define the R&S SZU settings are the same as the R&S SMW200A commands, so that you can reuse your SCPI scripts. Note the changes in the value ranges and the commands usage listed in chapter "Remote Control" in the description SZU100A Getting Started.

For step-by-step description, see:

- [Section 4.9.6, "How to connect and configure external instruments"](#), on page 189

### 10.5.5 Further information

For information on the possible scenarios and test setups, see:

- [Section 4.1.2, "Test scenario and required system configuration"](#), on page 102

For description of the settings related to connection establishment, see:

- [Section 4.4.3, "External RF and I/Q settings"](#), on page 129

- [Section 4.4.2, "I/Q stream mapper settings"](#), on page 127

For information on the manual and remote control operation of the external instruments, see the documentation of the particular instrument:

- For R&S SZU, see the SZU100A Getting Started
- For R&S SGT, see the SGT100A User Manual

# 11 File and data management

The R&S SMW200A uses files to save all instrument data. The instrument allows you to save and to load instrument settings, and to import and to export user data for processing in another instrument or later. Finally, you can create a screenshot of the current settings displayed on the screen and save it as a file.

The main save and recall function for managing of the instrument settings is available via the SAVE/RCL key. Dedicated save/recall functions are available in the settings dialogs of the digital standards or accessible whenever user files are used.

This section focuses on the functions provided for managing of user data files and covers the topics listed below.

For information on the related remote control commands, see [Section 14.7, "MMEMory subsystem"](#), on page 904.

For information on how to save the displayed setting in a file, see [Section 11.10, "Creating screenshots of current settings"](#), on page 731.

• <a href="#">About the file system</a> .....	699
• <a href="#">Restoring an instrument configuration</a> .....	702
• <a href="#">Protecting data</a> .....	707
• <a href="#">Saving and recalling settings</a> .....	708
• <a href="#">Accessing files with user data</a> .....	714
• <a href="#">Exporting and importing remote command lists</a> .....	718
• <a href="#">Loading, importing and exporting lists</a> .....	718
• <a href="#">Using the file manager</a> .....	719
• <a href="#">Transferring files from and to the instrument</a> .....	725
• <a href="#">Creating screenshots of current settings</a> .....	731

## 11.1 About the file system

Depending on their content, this description distinguishes between system files and user files. System files and the system directory are protected and not accessible. User files contain user-defined configurations or data.

This section focuses on user files. It provides an overview of the R&S SMW200A file system and covers the following topics:

- ["Types of user data"](#) on page 700
- ["File storage location"](#) on page 700
- ["File handling"](#) on page 701
- ["File naming conventions"](#) on page 701
- ["File extensions"](#) on page 701
- ["File contents"](#) on page 702

### Types of user data

The following data types contain user data:

- Settings or configuration files, for example, you save the current instrument settings and load these settings on another instrument.  
See [Section 11.4, "Saving and recalling settings"](#), on page 708.
- SCPI scripts that contain a series of commands. You can run the script to perform a task.  
See [Section 11.6, "Exporting and importing remote command lists"](#), on page 718.
- Externally generated waveforms. You can load the waveform files at the ARB application on the instrument.  
See [Section 5.7, "Using the arbitrary waveform generator \(ARB\)"](#), on page 302
- Externally or internally generated lists, for example, user correction lists. You can load these list files on the instrument.  
See [Section 11.7, "Loading, importing and exporting lists"](#), on page 718 and [Section 11.5, "Accessing files with user data"](#), on page 714.
- Externally or internally generated complex modulation data and control data. You can load these data files on the instrument.  
See [Section 11.5, "Accessing files with user data"](#), on page 714.

Depending on the **data storage method**, user data can be:

- *Persistent*, i.e. user files that are recorded on the data storage.  
Data is preserved when instrument is powered off and can be accessed and modified subsequently.
- *Temporary*, i.e. volatile data that the instrument retains while it is powered on.  
Volatile data is immediately lost when the R&S SMW200A is switched off.

### File storage location

Without any additional measures, the R&S SMW200A stores user files on the internal memory or if connected, on a memory stick.

Both, the user directory `/var/user/` on the internal memory or the `/usb/` directory on the memory stick, can be used to **preserve** user-defined data. Any directory structure can be created.

The `/var/volatile` directory serves as a RAM drive and can be used to protect sensitive information. The data is available **temporarily**.

### Default storage location

The R&S SMW200A stores user data in the user directory.

In the file system, user directory is always indicated as `/var/user/`.

In manual control, you access this directory via the "File Manager", see [Section 11.8, "Using the file manager"](#), on page 719. In remote control, you can query it with the command `:SYSTem:MMEMory:PATH:USER?`.

To query and change the default directory used for mass storage, use the command `:MMEMory:CDIRectory`.

## File handling

To *access files* and the file system of the instrument or to use the general file management functions such as copying and moving data, use the standard "File Manager" dialog.

See [Section 11.8, "Using the file manager"](#), on page 719.

To *transfer files* from and to the instruments or to exchange files, use one of the following alternatives:

- Connect a memory stick to one of the USB interfaces.  
The instrument automatically recognizes a connected memory stick and assigns the `/usb/` drive to it.
- Connect the instrument to a LAN.  
An instrument connected to a LAN supports two standard file transfer methods from a remote client:
  - FTP (file transfer protocol)
  - File sharing according to the SAMBA/SMB (server message block) protocol.Both file transfer methods open the folder `/user` that is the `/var/user/` folder on the instrument.  
For a step-by-step description, see [Section 11.9, "Transferring files from and to the instrument"](#), on page 725.
- Map a network folder or a computer to an instrument connected to a LAN.  
A mapped network folder is indicated as `/shares/<"Local Folder">`.  
For a step-by-step description, see [Section 11.8.4, "Mapping a network folder"](#), on page 723.

## File naming conventions

To enable files to be used in different file systems, consider the following file naming conventions:

- The *filename* can be of any length and *is case-sensitive*, i.e it is distinguished between uppercase and lowercase letters.
- All letters and numbers are permitted (numbers are, however, not permitted at the beginning of the filename).
- Avoid using special characters.
- Do not use slashes "\" and "/". These symbols are used in file paths.
- Avoid using the following filenames: `CLOCK$, CON, COM1 to COM4, LPT1 to LPT3, NUL or PRN`  
They are reserved by the operating system.

## File extensions

The R&S SMW200A distinguishes the files according to their extensions; each type of file is assigned a specific file content and also a specific file extension. The extension is usually of no consequence to you since access to the files occurs in the individual dialogs where only the relevant type of file is available. For example, files with user correction data can only be saved and loaded in the "UCOR" dialog.

See [Section A, "Available user files and file extensions"](#), on page 1378 for an overview of the supported file extensions.

### File contents

To maintain the file size and to accelerate processing times, the instrument saves settings that deviate from their default values. Considered is also configuration data for the operating elements and lists with user data, e.g. dialog positions and a list of user correction data. However, if a list data is part of the instrument settings, a reference to this list is saved, not the list itself.

This approach ensures that the created files contain only relevant information and allows you to transfer instrument settings even between different equipped signal generators. During the recall process, the instrument interprets only the relevant settings; all non-referenced parameters are set to their preset values. Error messages indicate the settings which cannot be implemented, like referencing non-existing lists or the attempt to activate settings which are not supported by the instrument.

## 11.2 Restoring an instrument configuration

The R&S SMW200A has various options to set default settings. You can preset the R&S SMW200A to an initial state at any time as a known starting point for configurations. It is often useful as a first step during troubleshooting when unusual results arise.

The figure [Figure 11-1](#) shows the impact of the particular reset functions.

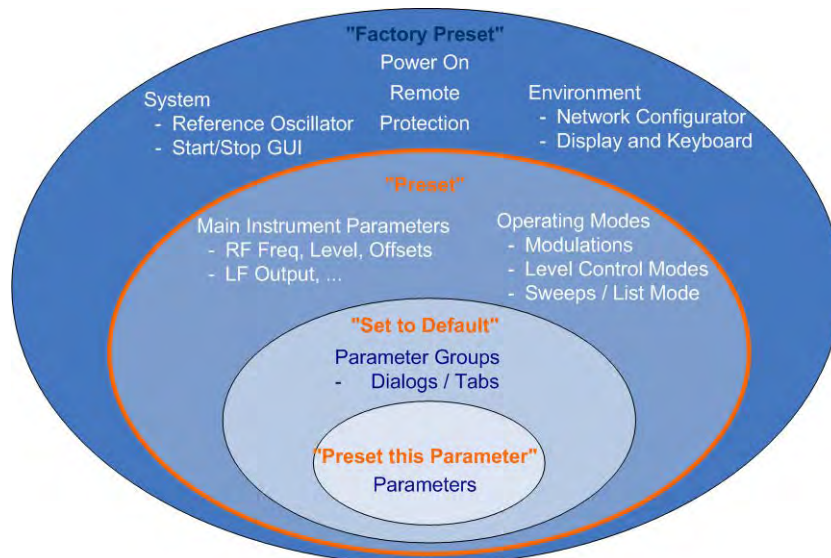

*Figure 11-1: Preset functions for parameters and operating modes*

### Overview of the characteristics of the preset functions

Select the preset option that most fits to your particular application:



- [PRESET]  
It is the most frequent function. A preset executes a defined instrument setup to provide an initial instrument state as a basis for a new configuration. It resets all parameters and switching states including the states of inactive operating modes. Also, it resets external instruments connected to the R&S SMW200A. A preset does not change network settings, remote access settings or system settings.
- ▶ To execute a preset, press the [PRESET] key at the front panel.

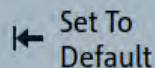

- "Set to Default"  
This function relates to individual dialogs or tabs and resets the associated settings of the corresponding dialog. All other settings are retained. For example, you can use it to reset all digital modulation settings in the "Custom Digital Mod" dialog.
- ▶ To reset the settings, click "Set To Default".

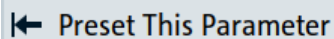

- "Preset this parameter"  
Sets a single parameter to its default value.
1. To reset an individual parameter, open its context-sensitive menu.
  2. Select "Preset This Parameter".

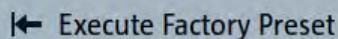

- "Factory Preset"  
A factory preset is the most profound preset function that resets almost all instrument settings, including reference oscillator, network and remote access settings. A factory preset does not change the following settings:
    - Security, password, and settings protected by these passwords
    - User-defined data, like setups or data lists
    - Settings that relate to an integration of the instrument in a measurement setup.
- ▶ **NOTICE!** Execute a "Factory Preset" only if it is necessary. After a "Factory Preset", the network connection to the instrument no longer exists. To restore the factory defaults, select "System Config" > "Setup" > "Settings" > "Factory Preset". See "[Execute Factory Preset](#)" on page 705.

### Presetting the instrument to a user-defined state

The reset functions set the parameters and operating modes to default values predefined by the factory. Alternatively to these default settings, you can:

Alternatively to recalling the instrument default settings, you can preset the instrument to a user-defined state as follows:

- Restore user-specific settings after a preset, see [Section 11.2.3, "Presetting the instrument to a user-defined state"](#), on page 706.
- Save and reload user-defined instrument states, see [Section 11.4.2, "Saving and recalling instrument settings"](#), on page 712.

### Marking parameters with non-default values

To check the current state of the settings concerning default values, the R&S SMW200A offers a feature that visually identifies deviations from the default values.

For more information, see [Section 11.2.2, "Identifying parameters with non-default values"](#), on page 705.

## 11.2.1 Preset, set to default and factory preset settings

<a href="#">Preset</a> .....	704
<a href="#">Set To Default</a> .....	705
<a href="#">Preset this Parameter</a> .....	705
<a href="#">Execute Factory Preset</a> .....	705

### Preset

Resets all parameters and switching states, and closes all opened dialogs.

External instruments connected to the R&S SMW200A are also preset, see [Section 4.4.3, "External RF and I/Q settings"](#), on page 129.

#### Note:

In contrast to the [PRESET] key, the SCPI commands `*RST` and `:SYSTEM:PRESet` do not close open dialogs in the GUI.

Consider also the following possibilities:

- You can define the settings that are restored when you preset the instrument (see [Section 11.2.3, "Presetting the instrument to a user-defined state"](#), on page 706)
- In remote control, you can preset the settings of the two instrument paths separately (see [Section 14.6, "Preset commands"](#), on page 903)
- You can reset the instrument to the factory state (see ["Execute Factory Preset"](#) on page 705)

See also [Table 11-1](#) that contains the key parameters that are reset by the corresponding preset functions.

Remote command:

`*RST` on page 901



**Set To Default**

Resets the associated settings of the corresponding dialog or tab.

Remote command:

For example, [:SOURce<hw>]:BB:<Digital Standard>:PRESet

**Preset this Parameter**

Restores the default value of a single parameter.

**Execute Factory Preset**

Resets the instrument to its factory settings.

**Note:** "Factory Preset" retains all security settings and does not delete any user files like setups or user data.

See also [Table 11-1](#) that contains the key parameters that are reset by the corresponding preset functions.

Remote command:

:SYSTem:FPReset on page 904

## 11.2.2 Identifying parameters with non-default values

To recognize the current state of the settings related to their default values at the first glance, enable a function that visually identifies parameters in states different than preset.

To enable this display:

1. To open the context-sensitive menu, touch and hold the screen anywhere in the GUI of the R&S SMW200A.
2. Select "Mark All Parameters Changed from Preset".

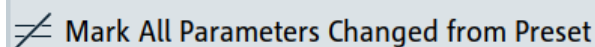

✓ Mark All Parameters Changed from Preset

If enabled, marks the parameters that deviate from their default values.

**Example:**

Frequency	4.000 000 000 000 GHz		
Offset	0.000 Hz	Multiplier	1.000
User Variation			
Variation Active	<input checked="" type="checkbox"/>	Variation Step	1.000 000 000 MHz

**Figure 11-2: Marked parameters show that the value deviates from its default**

Frequency	= changed (default = 1 GHz)
Offset	= changed (default = 0 kHz)
Multiplier	= unchanged
Variation active	= changed (default = disabled)
Variation step	= unchanged

### 11.2.3 Presetting the instrument to a user-defined state

You can define the settings that are restored when you preset the instrument.

1. Configure the settings as required.
2. Save them as described in [Section 11.4.2, "Saving and recalling instrument settings"](#), on page 712:
  - a) Save the settings as a file with the predefined filename  
`UserPreset.savrc1txt`.
  - b) Save this file in the directory `/var/user/`.

The filename `UserPreset.savrc1txt` and the directory `/var/user/` are mandatory.

3. Press the [PRESET] key.  
When operating the instrument remotely, send the `*RST` command.

The instrument restores these user-defined settings. An "Info" message appears and confirms loading of a file with user-defined preset settings.

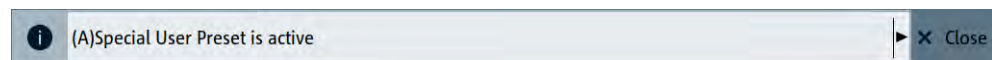

### 11.2.4 Reference

See [Table 11-1](#) for an overview of the main generator settings that are affected by the corresponding preset functions. While the regular [PRESET] key primarily resets the signal relevant parameters of the instrument, the "Factory Preset" affects almost all instrument settings.

For information on the default values of further parameters, see the description of the corresponding remote commands.

Table 11-1: Key parameters affected by preset and factory preset

Parameter	Preset value	Preset	Factory Preset
RF frequency	1 GHz	x	x
RF level (RF output)	off	x	x
Offsets	0	x	x
Modulation state	off	x	x
LF output state	off	x	x
Sweep state	off	x	x
List mode state	off	x	x
Reference frequency settings	-	-	x
Network settings	-	-	x
Hostname	-	-	x
GPIB address	-	-	x
Start or stop display update	-	-	x
Display and keyboard settings	-	-	x
Preset behavior: Keep connections to external instruments	off	-	x
Password and password-protected settings	-	-	-
Security settings	-	-	-
User files (setups, user correction, etc.)	-	-	-
HUMS	off	-	x

## 11.3 Protecting data

During operation, the R&S SMW200A saves user data permanently in the user directory, see "[File storage location](#)" on page 700.

**To protect any classified data and to avoid saving any sensitive data on the R&S SMW200A permanently**, you have the following options:

- Activate the **volatile mode**. This mode redirects user data to the volatile memory, see "[Volatile Mode](#)" on page 796.  
The internal memory is write-protected.  
Once you power off the instrument for at least five minutes, all volatile memory modules lose their contents.  
To avoid losing this data, connect an **external memory device**, for example, a USB flash drive.  
See also:
  - "[Default storage location](#)" on page 700

- "Volatile Mode" on page 796
- Section 11.9.4, "Using a USB storage device for file transfer", on page 729
- Save user files **temporarily in the `/var/volatile` directory**, which remains available only until the instrument is turned off.  
You can access data in the volatile memory just as data that is saved permanently in the `/var/user/`.  
See also Section 11.8.3, "Displaying all saved files", on page 723.

#### To remove the system drive

1. **NOTICE!** You can damage the instrument and loose data, when removing the system drive during operation.  
Switch off the R&S SMW200A.  
See "To shut down the product" on page 38.
2. Remove the system drive from the instrument.

For detailed information on how to protect the instrument and to protect sensitive data from unauthorized access, refer to the document Instrument Security Procedures.

## 11.4 Saving and recalling settings

You can save and recall instrument settings, user settings and other related data for the following use cases:

- Reload or repeat a specific signal generation task on the instrument.
- Transfer a specific configuration of your instrument to another instrument, for example in multi-instrument setups.
- Transfer a specific configuration of an instrument path to another instrument path.
- Save or load complete instrument settings to or from a file.
- Save or load settings of a particular digital standard or a firmware option.

#### Save or recall the complete instrument settings

Two different methods are available for managing *complete instrument settings*:

- Quick (immediate) Save/Recall  
A defined set of instrument settings are saved or recalled quickly in just one step, without defining a filename or storage location. This function enables a fast switching between different instrument settings.
- Save/Recall in files with user-defined names  
The defined set of instrument settings are saved to a definable storage location. The file extension is `*.savrc1.txt`.  
Settings files created in this way are visible in the file system and accessible with the supported methods for file handling.

In the general case, a recall process replaces the instruments settings with the saved values. An exception is the frequency and level settings. During recall of the instrument

settings, it is possible to retain the current settings or to overwrite them with the saved values.

### Save/Recall the settings belonging to a firmware option

Each of the firmware option provides a special "Save/Recall" function to manage directly the settings associated to the corresponding digital standard, e.g. all settings in the "3GPP FDD" dialog.

The "Save/Recall" function creates files with user-defined names, predefined file extension and on a definable storage location. The files are accessible with the supported methods for file handling.

## 11.4.1 Save/Recall settings

Access:

1. Press the [SAVE/RCL] key.
2. Select "Operation Mode" > "Save" or "Recall" to open the corresponding settings.

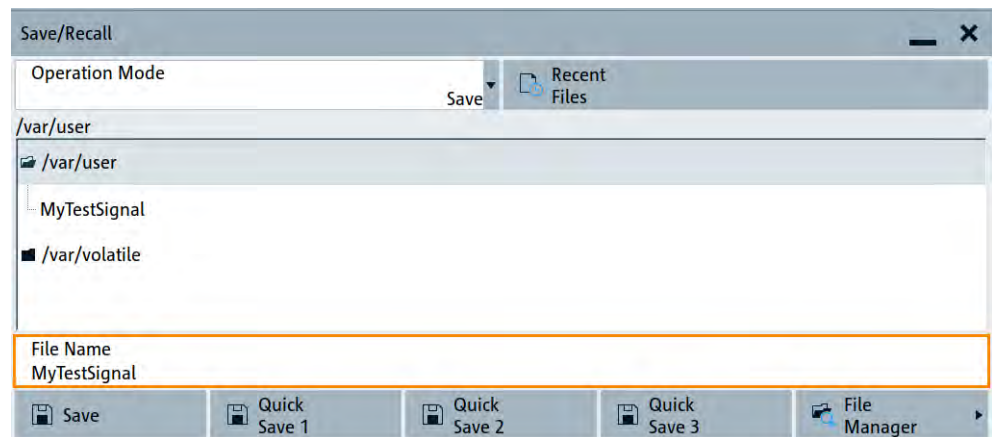

The settings for both operation modes are similar and related.

### To access save or recall settings of a firmware option

- In the general dialog of the corresponding digital standard, select the "Save" or "Recall" function.

For example, select "Baseband" > "EUTRA/LTE" > "General" > "Save".

The name of the dialog is context-sensitive and differs depending on the particular digital standard. The provided functions are similar.



### Settings:

Operation Mode.....	710
Directory, File List and Filename.....	710
Recent files.....	711
Show SCPI List.....	711
SCPI List.....	711
Save.....	711
Quick Save x.....	711
Exclude Frequency.....	712
Exclude Level.....	712
Recall.....	712
Quick Recall x.....	712
File Manager.....	712

### Operation Mode

Accesses the settings for storing ("Save") and loading ("Recall") of the instrument settings. Also, you can import SCPI-Files ("SCPI-Import") or export SCPI files ("SCPI-Export").

See [Section 11.6, "Exporting and importing remote command lists"](#), on page 718.

### Directory, File List and Filename

#### Note:

You access this generic standard function each time you perform one of the following:

- Save or load (settings) files
- Define a folder in that these files are saved
- Navigate through the file system.

The dialog name changes depending on the context. The provided functions are self-explanatory and similar.

Use the settings for example as follows:

- To navigate through the file system, use the directory tree.

- To create a file, load and save files, use the dedicated functions "New", "Select", [Save](#), and [Recent files](#).
- To access the general data table editor, use the "Edit" button
- To perform standard file management functions, like create directories, move, copy, delete files and/or directories, use the standard "File Manager" function (see [Section 11.8](#), "Using the file manager", on page 719).

Remote command:

To list all files in a directory:

[:MMEMory:CDIRectory](#) on page 910

[:MMEMory:CATalog?](#) on page 910

Refer to the description of firmware options for the syntax of the corresponding SCPI command:

[\[:SOURce<hw>\]:BB:<Digital Standard>:SETTing:CATalog](#)

[\[:SOURce\]:CORRection:CSET:CATalog?](#) on page 1190

To list files with user data:

[\[:SOURce<hw>\]:BB:DM:DLISt:CATalog?](#) on page 1086

[\[:SOURce<hw>\]:BB:DM:CLISt:CATalog?](#) on page 1086

### Recent files

Displays the files last used.

### Show SCPI List

Opens the "SCPI List", which lists the current settings of the R&S SMW200A as SCPI commands.

The R&S SMW200A provides this function for [Operation Mode > SCPI-Export](#).

### SCPI List

Provides a list of all SCPI commands corresponding to the current instrument settings.

### Save

Saves the current instrument settings or the settings belonging to a digital standard under the defined filename.

Remote command:

[:MMEMory:STORe:STATe](#) on page 916

Refer to the descriptions of the firmware options for the correct syntax of the corresponding SCPI commands:

[\[:SOURce<hw>\]:BB:<Digital Standard>:SETTing:STORe](#)

[\[:SOURce<hw>\]:BB:<Digital Standard>:SETTing:DELeTe](#)

### Quick Save x

Stores the current instrument setting in one of the intermediate memories.

These instrument settings are retained until a different instrument setting is stored in the intermediate memory. When the instrument is switched off, the contents of the intermediate memories are retained.

Remote command:

[\\*SAV](#) on page 901

**Exclude Frequency**

The current frequency is retained when a stored instrument setting is loaded.

Remote command:

`[ :SOURce<hw> ] :FREQuency [ :CW | FIXed ] :RCL` on page 1203

**Exclude Level**

The current level is retained when a stored instrument setting is loaded.

Remote command:

`[ :SOURce<hw> ] :POWer [ :LEVel ] [ :IMMediate ] :RCL` on page 1278

**Recall**

Restores the selected configuration.

During recall, the instrument considers all related settings, for example sweeps in active state or lists. An error message indicates the settings which cannot be implemented.

Remote command:

`:MMEMory:LOAD:STATe` on page 914

Refer to the descriptions of the firmware options for the correct syntax of the corresponding SCPI command:

`[ :SOURce<hw> ] :BB:<Digital Standard>:SETTing:LOAD`

**Quick Recall x**

Loads the selected configuration from one of the intermediate memories. A message appears if no instrument configuration is stored in this memory.

Remote command:

`*RCL` on page 901

**File Manager**

Accesses the "File Manager" dialog, see [Section 11.8, "Using the file manager"](#), on page 719.

## 11.4.2 Saving and recalling instrument settings

Instrument settings can be saved to a file and loaded again later, so that you can repeat the tests with the same settings.

**To access and recall instrument setups quickly**

- ▶ Assign the appropriate action to the [USER] key.  
See [Section 12.4.2, "How to assign actions to the \[USER\] key"](#), on page 767.

**To save and recall instrument settings**

1. Select "System Config" > "Setup" > "Settings" > "Save / Recall" > "Operation Mode" > "Save".
2. Select "Quick Save 1".



The instrument saves its settings in the intermediate memory 1. The filename and the storage location cannot be changed.

3. Adapt the instrument settings as required. Select "Quick Save 2"
4. To restore the settings, select the "Operation Mode > Recall"
5. Select "Quick Recall 1"

The instrument is restored to the previous state.

6. Select "Quick Recall 2" to switch to the settings saved in the second file.

#### To save complete instrument settings

1. Select "System Config" > "Setup" > "Settings" > "Save / Recall" > "Operation Mode" > "Save".
2. In the file selection dialog, select a filename and storage location for the settings file.
3. Select "Save".

A file with the defined name and path and the extension \*.savrc1.txt is created.

#### To restore an instrument configuration

Save the configuration as described in ["To save complete instrument settings"](#) on page 713.

1. To restore settings, select "System Config" > "Setup" > "Settings" > "Save / Recall" > "Operation Mode > Recall".
2. To retain the current frequency settings, enable "Save"/"Recall" > "Exclude Frequency",
3. To retain the current level settings, enable "Save"/"Recall" > "Exclude Level",
4. In the file select dialog, select the filename and storage location of the settings file.

The settings are restored, but the frequency and level settings are retained. You can repeat the signal generation with the same settings.

See also [Section 11.2.3, "Presetting the instrument to a user-defined state"](#), on page 706.

### 11.4.3 Recalling firmware option settings

Some test setups, e.g. for MIMO tests, require that two or more instruments generate baseband signal with similar settings. One easy way to speed up the configuration is to use the dedicated save/recall function to transfer the configuration data from one instrument to the other.

#### To transfer settings of a digital standard to another instrument

1. In the first instrument, select for example "Baseband" > "3GPP FDD".

Adjust the settings as required.

2. In the "General" tab, select "Save".  
In the file selection dialog, select a filename and storage location for the settings file.  
A file with the defined name and path and a predefined extension (\*.3g) is created.
3. Connect both instrument to a LAN.  
Alternatively, use a USB flash drive to transfer the created \*.3g file to the second instrument.
4. In the second instrument, select "Baseband > 3GPP FDD > General > Recall" to load the saved file.
5. Navigate in the file selection dialog. Select the filename and storage location of the settings file.  
The settings are loaded in the second instrument. If the corresponding settings are left unchanged, the second instrument generates a signal with identical baseband settings.

## 11.5 Accessing files with user data

By the calculation of signals according to the different digital standards or by the generation of custom digitally modulated signals, the R&S SMW200A uses the data from different data sources (see also [Section 5.5.1.1, "About data signals"](#), on page 224). To simulate the signal of one UE for instance, the instrument modulates and codes the provided data for each channel. It further processes the signal as described in the corresponding standard.

Whenever a data list file is enabled as a data source, the instrument provides direct access to the standard "File Select" function. This function enables you to select, create and edit the data list files.

### 11.5.1 File select settings

The "File Select" dialog opens automatically each time you select a data list file as data source or you select a control list.

#### To access a loadable data list file

1. Select the "Data List Name" in the individual dialog.  
For "Baseband > 3GPP FDD > Base Stations > BS1 > Channel Table > P-CCPCH > Data = Data List", for example, select "DList Patt = None".

A file select dialog for loading, creating and modifying a file opens.

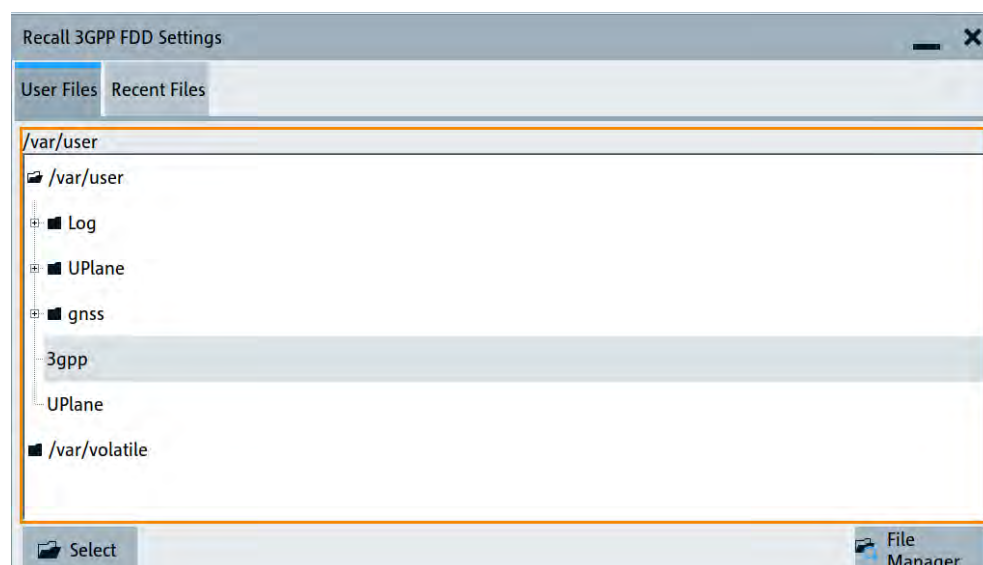

**Tip:** The name of the dialog is context-sensitive and differs depending on the particular function this dialog is from. However, the provided functions are similar.

2. To load an existing file:  
Navigate through the file system.  
Select the file and confirm with "Select".
3. To create a file, for example if there is no data list file specified:  
Navigate through the file system.  
Select "New" and specify the filename.  
A new empty file is created and saved in the selected folder.
4. To edit an existing or newly created file:  
Navigate through the file system.  
Select the file and select "Edit".  
The standard "Data List Editor" dialog opens  
See [Section 5.6.3.7, "Data list editor"](#), on page 282.

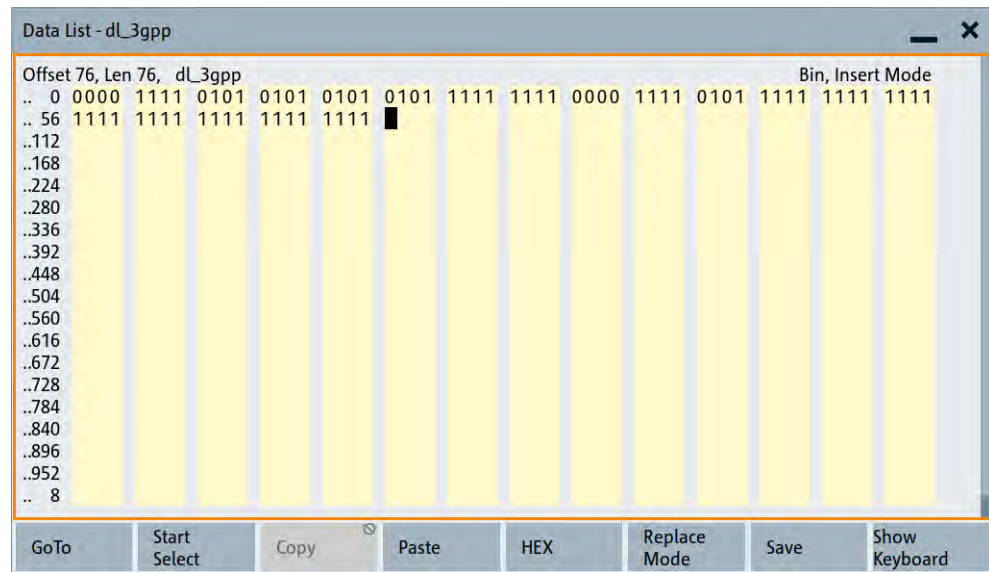

5. Edit the file content.  
Confirm with "Save".

### Settings:

<a href="#">Directory, File List and Filename</a> .....	716
<a href="#">Functions for handling of data lists</a> .....	717
<a href="#">Functions for handling of control lists</a> .....	717
<a href="#">Recent files</a> .....	717
<a href="#">File Manager</a> .....	717

### Directory, File List and Filename

#### Note:

You access this generic standard function each time you perform one of the following:

- Save or load (settings) files
- Define a folder in that these files are saved
- Navigate through the file system.

The dialog name changes depending on the context. The provided functions are self-explanatory and similar.

Use the settings for example as follows:

- To navigate through the file system, use the directory tree.
- To create a file, load and save files, use the dedicated functions "New", "Select", Save, and Recent files.
- To access the general data table editor, use the "Edit" button
- To perform standard file management functions, like create directories, move, copy, delete files and/or directories, use the standard "File Manager" function (see [Section 11.8, "Using the file manager"](#), on page 719).

Remote command:

To list all files in a directory:

[:MMEMory:CDIRectory](#) on page 910

[:MMEMory:CATalog?](#) on page 910

Refer to the description of firmware options for the syntax of the corresponding SCPI command:

`[ :SOURce<hw> ] :BB :<Digital Standard> :SETTing :CATalog`

[\[ :SOURce \] :CORRection :CSET :CATalog?](#) on page 1190

To list files with user data:

[\[ :SOURce<hw> \] :BB :DM :DLISt :CATalog?](#) on page 1086

[\[ :SOURce<hw> \] :BB :DM :CLISt :CATalog?](#) on page 1086

### Functions for handling of data lists

Provided are the following standard functions for file handling:

- |          |   |
|----------|---|
| "Select" | Select and load the file.<br>Remote command:<br><a href="#">[ :SOURce&lt;hw&gt; ] :BB :DM :DLISt :SElect</a> on page 1087<br>Refer to the descriptions of the firmware options for the correct syntax of the corresponding SCPI command:<br><code>[ :SOURce&lt;hw&gt; ] :BB :&lt;Digital Standard&gt; :... :DATA DLISt</code><br><code>[ :SOURce&lt;hw&gt; ] :BB :&lt;Digital Standard&gt; :... :DSElect</code> |
| "New"    | Creates file with the specified "Filename".<br>To confirm, select "OK"; use "Cancel" to undo the operation.<br>To edit the file content, select "File Select > Edit".   |
| "Edit"   | Accesses the "Data List Editor" and loads the selected file for editing<br>See <a href="#">Section 5.6.3.7, "Data list editor"</a> , on page 282.   |

### Functions for handling of control lists

Provided are the following standard functions for file handling:

- |          |   |
|----------|---|
| "Select" | Select and load the file.<br>Remote command:<br><a href="#">[ :SOURce&lt;hw&gt; ] :BB :DM :CLISt :SElect</a> on page 1087       |
| "New"    | Creates file with the specified name. To edit the file content, select "File Select > Edit".                                    |
| "Edit"   | Access the "Control List Editor" and loads the selected file for editing, see <a href="#">Control and marker lists editor</a> . |

### Recent files

Displays the files last used.

### File Manager

Accesses the "File Manager" dialog, see [Section 11.8, "Using the file manager"](#), on page 719.

## 11.5.2 Creating data lists and control lists

The general principle for accessing files with user data is described in ["To access a loadable data list file"](#) on page 714. Detailed and further information on how to create

and access files with user data like data lists and control lists is provided in the following sections:

- [Section 5.6.4.2, "How to create and assign a data list"](#), on page 290  
Overview of the possible ways and detailed description on how to create data lists.
- [Section 5.6.4.1, "How to create and assign a control list"](#), on page 288  
Overview of the possible ways and detailed description on how to create control lists.
- [Section 14.7.2, "Handling files in the default or in a specified directory"](#), on page 906  
Information on accessing files in a remote environment

## 11.6 Exporting and importing remote command lists

To set specific instrument settings or perform tasks automatically, you can create scripts or import scripts that contain the settings in the form of remote control command sequences.

The R&S SMW200A also offers a SCPI macro recorder with code generator to record manual settings and create an executable script.

Completed scripts are saved in files and possibly converted to different formats, depending on the language of the source code.

The R&S SMW200A supports the following commonly used languages:

- Plain SCPI: \*.txt
- MATLAB: \*.m
- NICVI: \*.c
- Python: \*.py

It is also possible to convert the SCPI command list to a user-specific language.

How to: [Section 13.9, "Using remote command scripts"](#), on page 874

## 11.7 Loading, importing and exporting lists

The R&S SMW200A provides built-in editors for creating list files, for example for the list mode or lists with user correction data. You can also create or evaluate them with an external application. The instrument provides interfaces with the following functionality:

- Import and export list files in a standard ASCII format file
- Load files with modulation and control information
- Load an internally or an externally generated waveform file

Lists are saved and loaded in the corresponding dialogs. For example, the user correction data list is created and saved in the "User Correction" dialog.

Waveform files are created with the signal generation software R&S WinIQSIM2 or in the dialogs of some of the digital standards.

For more information, see the following sections:

- [Section 11.5.2, "Creating data lists and control lists"](#), on page 717
- [Section 8.12.3.4, "Import/export list files"](#), on page 598

## 11.8 Using the file manager

The "File Manager" is a tool similar to a standard Windows Explorer. It helps you manage mass storage media and files saved on the R&S SMW200A.

You can perform the following tasks:

- Copying multiple files from disk to other media  
See [Section 11.9, "Transferring files from and to the instrument"](#), on page 725
- Copying files into another directory  
See [Cut, Copy&Paste and Delete](#)
- Renaming and deleting files
- Creating directories  
See [Create New Directory](#)
- Mapping shared network folders  
See [Section 11.8.4, "Mapping a network folder"](#), on page 723
- Displaying saved files  
See [Section 11.8.3, "Displaying all saved files"](#), on page 723

### 11.8.1 File manager settings

Access:

- ▶ Select "System Config" > "Setup" > "Settings" > "Save / Recall" > "File Manager".

**Tip:** Each "Save/Recall" dialog and each "File Select" dialog provides a quick access to the "File Manger".

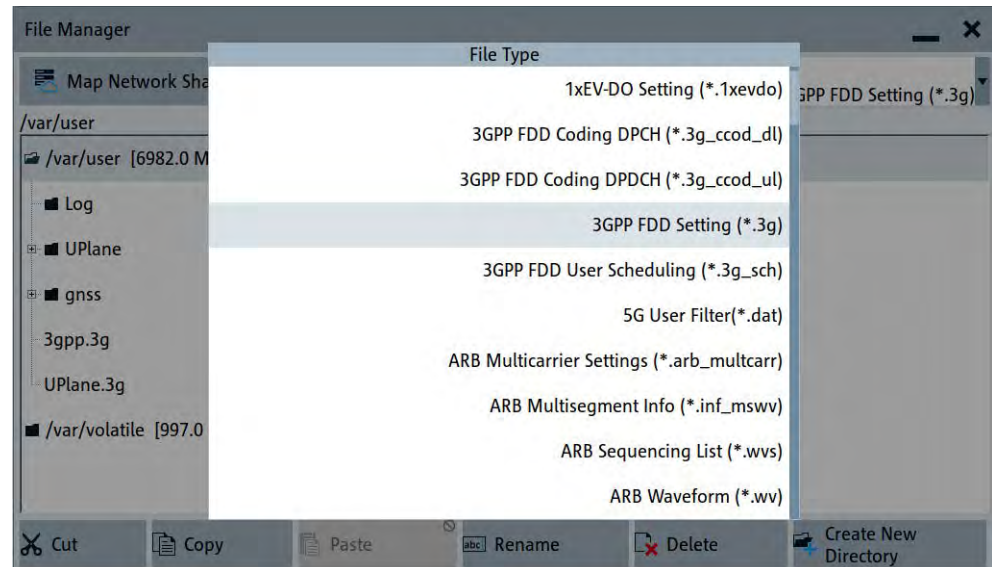

The "File Manager" dialog provides all standard functions required for file management. It displays the contents of the selected folder on the R&S SMW200A and provides functions to rename, delete, copy, or move individual files.

### Settings:

Map Network Share.....	720
File Type.....	720
Directory and Filename.....	720
Cut, Copy&Paste and Delete.....	721
Rename.....	721
Create New Directory.....	721

### Map Network Share

Opens a dialog where you can map one or more network folders. See [Section 11.8.2, "Map network share settings"](#), on page 721.

See also [Section 11.8.4, "Mapping a network folder"](#), on page 723.

### File Type

Selects the file type to be listed. If a file type with a specific file extension is selected, only files with this extension are listed.

See [Section A, "Available user files and file extensions"](#), on page 1378 for an overview of the supported file extensions.

### Directory and Filename

Selects the directory in which the file to be deleted or copied is located. The dialog lists all files in this directory. Selected files are highlighted. The path is indicated above the directory tree.



Unlike the "Save/Recall" and "File Select" dialogs, the "File Manager" displays the full filenames including extensions.

Remote command:

[:MMEMory:CDIRectory](#) on page 910

### **Cut, Copy&Paste and Delete**

Standard file management functions.

Before a file is deleted, you have to confirm the delete operation.

Remote command:

[:MMEMory:DELeTe](#) on page 914

[:MMEMory:COpy](#) on page 911

### **Rename**

Renames the selected file or directory.

Remote command:

[:MMEMory:MOVE](#) on page 915

### **Create New Directory**

Creates a folder and opens an edit dialog box to enter name and path (absolute or relative to the current directory) of the new folder.

Remote command:

[:MMEMory:MDIRectory](#) on page 915

## **11.8.2 Map network share settings**

Access:

- ▶ Select "System Config" > "Setup" > "Settings" > "Save / Recall" > "File Manager" > "Map Network Share".

The "Map Network Share" dialog provides settings that are similar to the standard Windows Explorer function "Map network drive". These settings help you to create up to 10 "shortcuts" to shared folders or computers in the network.

The dialog displays a list of current mapped network folders. The directory tree of the "File Manager", "Save/Recall", and "File Select" dialogs indicate a mapped network folder as `/shares/<"Local Folder">`.

Network Folder	Local Folder	User Name	Reconnect
//10.102.188.167/user	setups	instrument	On

Network Folder	//10.102.188.167/user	Local Folder	setups
User Name	instrument	Password	
Reconnect at Startup	<input checked="" type="checkbox"/>		

See also [Section 11.8.4, "Mapping a network folder"](#), on page 723.

### Settings:

<a href="#">Network Folder</a> .....	722
<a href="#">Local Folder</a> .....	722
<a href="#">User Name</a> .....	722
<a href="#">Password</a> .....	722
<a href="#">Reconnect at Startup</a> .....	722
<a href="#">Connect</a> .....	722
<a href="#">Change</a> .....	723
<a href="#">Disconnect</a> .....	723

### Network Folder

Enter the path of the folder or computer, e.g. //<IP Address>/user or //<server name>/user.

### Local Folder

Enter a letter or an alias name to describe the folder.

In the directory tree, a mapped network folder is indicated as /shares/<"Local Folder">.

### User Name

Enter a user name of a user that has the permission to access the selected network folder.

### Password

Enter the user password of the selected user.

### Reconnect at Startup

Enables reconnecting every time you start up the instrument.

### Connect

Triggers the instrument to prove the credential and to map (i.e. connect) the selected network folder or computer to the instrument.

You can map up to 10 network folders.

**Change**

Applies the changes.

**Disconnect**

Disconnects the network drive.

### 11.8.3 Displaying all saved files

**To display all files on the internal memory**

1. Select "System Config" > "Setup" > "Settings" > "Save / Recall" > "File Manager".
2. Navigate to `/var/user/`.

**To display all files on a connected USB flash drive**

1. Select "System Config" > "Setup" > "Settings" > "Save / Recall" > "File Manager".
2. Navigate to `/usb/`.

**To display all files in the volatile memory**

1. Select "System Config" > "Setup" > "Settings" > "Save / Recall" > "File Manager".
2. Navigate to `/var/volatile/`.

### 11.8.4 Mapping a network folder

Possibly you would like to transfer instrument or user settings to another R&S SMW200A, distribute waveform files to several instruments or you have to access frequently the same network drive. In these cases, on a R&S SMW200A connected to a LAN you can create a shortcut to this network folder or this computer.

How to: [Section 3.1.7, "Connecting to LAN"](#), on page 32

To map a network folder, proceed as follows:

1. On the computer or the network folder you want to map, enable remote access. You can specify a list of users allowed for remote access.  
**Note:** The remote access settings depend on the operating system the remote computer is using. For step-by-step instructions, refer to the documentation of the particular operating system.
2. On the R&S SMW200A, [enable file transfer via SMB \(samba\)](#).
3. Select "System Config" > "Setup" > "Remote Access" > "Network" to configure the following network settings:
  - a) Select "Address Mode" > "Auto (DHCP)".

- b) Check that the "DNS Suffix" and "DNS Server" are correct.
4. Press the [SAVE/RCL] key.
5. In the "Save/Recall" dialog, select "File Manager" > "Map Network Share".
6. In the "Map Network Share" dialog, select:
  - a) In the "Network Folder" field, enter `//<IP Address>/user` or `//<Server Name>/user`.  
For example, enter `//10.100.1.100/user`.
  - b) In the "Local Folder" field, enter an alias name, e.g. `setups`.
  - c) Enter the "User Name" and "Password" of a user with a remote access permission to the selected network folder.
  - d) If necessary, enable "Reconnect at Startup".
  - e) Select "Connect".

The selected network folder is mapped to your instrument. The list of mapped network folders is updated.

7. Close the "Map Network Share" dialog.

The navigation tree in the "File Manager" dialog displays the mapped network folder as `/shares/Setups`.

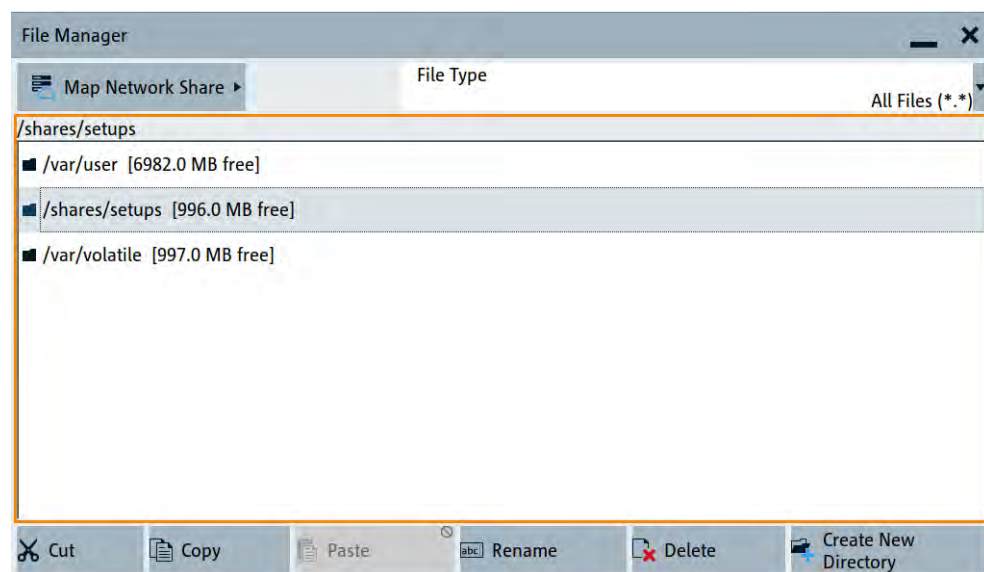

If the connection does not succeed, consider to check the following:

- Is the network folder or computer you try to map turned on?
- Is the network folder or computer enabled for remote access?
- Does the selected user name have the necessary permissions?

See also [Section 11.9.5, "Using a file server for test files exchange"](#), on page 730.

## 11.9 Transferring files from and to the instrument

As explained in "File handling" on page 701, you access the file system of the R&S SMW200A via one of the following ways:

- Via the built-in "File Manager"  
See [Section 11.8, "Using the file manager"](#), on page 719.
- On an instrument connected to a LAN:
  - Via one of the standard functions FTP or SMB (samba)  
See [Section 11.9.2, "Accessing the file system using FTP"](#), on page 726 and [Section 11.9.3, "Accessing the R&S SMW200A file system using SMB \(Samba\)"](#), on page 728
  - Via mapped network drives  
See [Section 11.8.4, "Mapping a network folder"](#), on page 723.
- Via a connected USB storage device  
See [Section 11.9.4, "Using a USB storage device for file transfer"](#), on page 729

Mainly because of security reasons, the access to the file system of your R&S SMW200A can be denied, because one or all these access methods are deliberately disabled. Access to the file system via LAN and/or USB requires that the corresponding service is enabled and a write access to the file system is enabled. Refer to [Section 11.9.1, "Removing file system protection"](#), on page 725 for description of the required steps.

This section provides an introduction to the topic. For comprehensive information, refer to the application note [1GP72: Connectivity of Rohde&Schwarz Signal Generators](#).

- [Removing file system protection](#)..... 725
- [Accessing the file system using FTP](#)..... 726
- [Accessing the R&S SMW200A file system using SMB \(Samba\)](#)..... 728
- [Using a USB storage device for file transfer](#)..... 729
- [Using a file server for test files exchange](#)..... 730

### 11.9.1 Removing file system protection

Before you try to access the file system via FTP, SMB (samba) or USB, fulfill the following:

- Disable write protection on the file system
- Enable the corresponding service or interface

#### To enable write permission on the file system

1. Select "System Config" > "Setup" > "Security" > "Security".
2. Select "General" > "Disk & Memory".
3. Enable "Volatile Mode".
4. Enter the "Security Password".

The default password is 123456. For more information, see [Section 12.7, "Using the security settings"](#), on page 794.

The R&S SMW200A requests a reboot.

5. Confirm the request.

The system reboots. The enabled settings are active.

#### To enable file transfer over FTP

1. Select "System Config" > "Setup" > "Security" > "Security".
2. Select "LAN Services" > "Common Services" > "LAN" > "On".
3. Enable "FTP"
4. Enter the "Security Password".  
The default password is 123456. For more information, refer to [Section 12.7, "Using the security settings"](#), on page 794.
5. Select "Accept".

#### To enable file transfer over SMB (samba)

1. Select "System Config > Setup > Security > Security > LAN Services"
2. Enable "LAN Interface"
3. Select "Samba Services".
4. Enable the "SMB 1.0/2.0 Client".
5. Enable the "SMB 1.0/2.0 Server".
6. Enter the "Security Password".  
The default password is 123456. For more information, see [Section 12.7, "Using the security settings"](#), on page 794.
7. Select "Accept".

#### To enable file transfer over USB

1. Select "System Config > Setup > Security > Security > General"
2. Select "Disk & Memory".
3. Enable "USB Storage"
4. Enter the "Security Password".  
The default password is 123456. For more information, see [Section 12.7, "Using the security settings"](#), on page 794.
5. Select "Accept".

### 11.9.2 Accessing the file system using FTP

If the R&S SMW200A is connected to a LAN, you can use file transfer protocol (FTP) to access the file system and to transfer files from and to the instrument.

How to: [Section 3.1.7, "Connecting to LAN"](#), on page 32

### To access the file system over FTP

We assume that the instrument and the remote PC are connected to a LAN.

1. [Enable file transfer via FTP](#)
2. [Enable write permission on the file system](#)
3. On the remote PC, start the Windows Explorer.
4. In the address field, enter `ftp://<"IP Address" of the Instrument>`, e.g. `ftp://10.124.0.166`.

**Tip:** The R&S SMW200A indicates its IP address on the block diagram.

A log-on dialog opens and requests a password.

The default user name and password is *instrument*.

#### Tip:

##### Default password

The FTP and SAMBA file access use the user "instrument" with default password "instrument".

We recommend that you change this password in the "Setup > Security > Password Management > Change User Password" dialog before connecting the instrument to the network.

See [Section 12.7.5, "Password management"](#), on page 804.

5. Enter the password to access the `user` directory.  
The `user` directory corresponds to the `/var/user/` directory of the instrument.

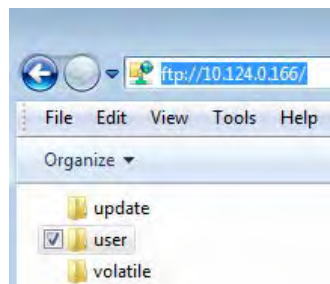

There, you can perform standard functions like creating directory, or saving files.

6. In the `user` directory, create a directory, e.g. `test ftp`.
7. Select "System Config" > "Setup" > "Settings" > "Save / Recall".  
Open the `/var/user/` directory.

The dialog displays the `/var/user/test ftp` directory.

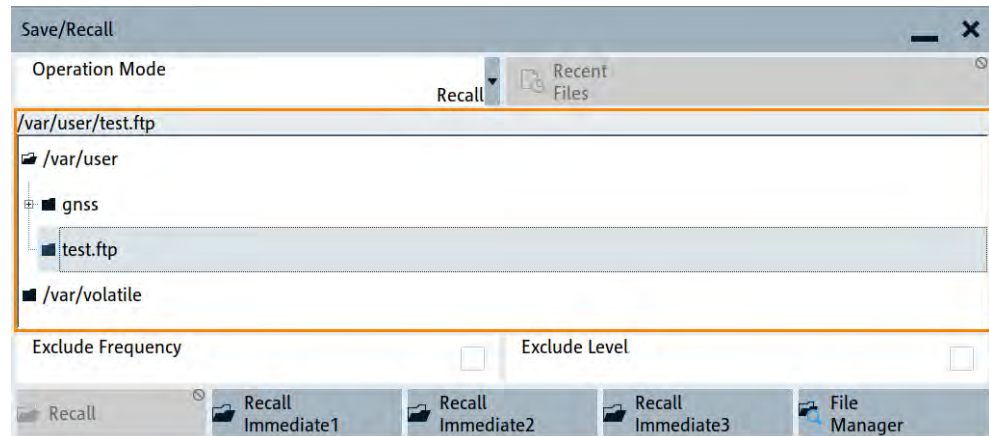

### 11.9.3 Accessing the R&S SMW200A file system using SMB (Samba)

The SMB (Samba) protocol is an alternative way to access the file system of the instrument from a remote PC. This protocol works if both the instrument and the PC are connected to a LAN.

How to: [Section 3.1.7, "Connecting to LAN"](#), on page 32

#### To access the file system over SMB

We assume that the instrument and the remote PC are connected to a LAN.

1. [Enable file transfer via FTP](#)
2. [Enable write permission on the file system](#)
3. On the remote PC, start the Windows Explorer.
4. In the address field, enter //["<IP Address" of the Instrument>](#), e.g. `ftp://10.124.0.166`.

**Tip:** The R&S SMW200A indicates its IP address on the block diagram.

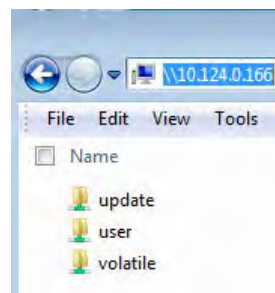

The `user` directory corresponds to the `/var/user/` directory of the instrument; the `volatile` directory - to the `/var/volatile` directory.



### To map the R&S SMW200A as a network drive to the remote PC

We assume that the instrument and the remote PC are connected to a LAN.

1. [Enable file transfer via SMB \(Samba\)](#)
2. [Enable write permission on the file system](#)
3. On the remote PC, start the Windows Explorer.  
Open the "Map Network Drive" dialog.
  - a) Select a valid "Drive", e.g. *W*.
  - b) In the "Folder" field, enter `//<"IP Address" of the Instrument>/user`  
or `//<"Hostname" of the Instrument>/user`  
For example: `//10.124.0.166/user` or `//SMW200A-102030/user`.  
**Tip:** The R&S SMW200A indicates its IP address on the screen.
  - c) Select "Finish".

A log-on dialog opens and requests a user name and a password.

#### Tip:

##### Default password

The FTP and SAMBA file access use the user "instrument" with default password "instrument".

We recommend that you change this password in the "Setup > Security > Password Management > Change User Password" dialog before connecting the instrument to the network.

See [Section 12.7.5, "Password management"](#), on page 804.

4. Enter the user name and the password of your instrument.

The `/var/user/` directory of the instrument is mapped to and displayed as a network drive of the remote PC.

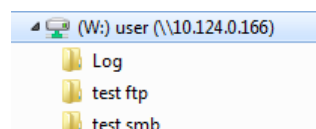

You can access the files in the `/var/user/` directory, perform standard function like creating directory, or saving files.

## 11.9.4 Using a USB storage device for file transfer

Alternatively to the file transfer possibility via LAN, you can use a USB storage device for direct file transfer from and to the instrument.

We recommend that you transfer files with user data (like lists or instrument setup files) to the instrument, rather than load and play them from a connected USB storage device.

**To transfer a file with user data to the instrument**

1. Connect a USB storage device, for example a USB memory stick to one of the USB interfaces of the instrument.

The R&S SMW200A recognizes the connected USB storage device automatically.

2. [Enable file transfer via USB](#)
3. [Enable write permission on the file system](#)
4. Select "System Config" > "Setup" > "Settings" > "Save / Recall".

The dialog displays the `/var/user/` directory and the `/usb/` drive.

5. In the "Save/Recall" dialog, select "File Manager".
6. In the directory tree, navigate to the `/usb/` drive.  
Select the required file with user data.
7. Select "Copy".
8. In the directory tree, navigate to the `/var/user/` directory.  
Select "Paste".

The file with user data is transferred to the instrument.

### 11.9.5 Using a file server for test files exchange

You can use a central file storage location like a file server in your company network to save setup files, SCPI scripts, application programs, or waveform files on it. Usually, you would like to distribute the files to several instruments. If the R&S SMW200As are connected to a LAN, you can create a shortcut on the instruments to the file server.

**To access the file server**

1. On each R&S SMW200A, map the required directory of the file server to the instrument.  
Perform the steps described in [Section 11.8.4, "Mapping a network folder"](#), on page 723.

2. On each R&S SMW200A, use the same alias name for the directory of the file server, i.e. enter the same "Local Folder" (in this example `Setups`).

On any of the R&S SMW200A, you access the file server directly from the "File Manager" and under the same name, e.g. `/shares/Setups`.

An extra advantage in remote control is that the same application program would control the instruments.

For example, use the remote control command `MMEemory:CDIRectory "/shares/Setups"` to set the default directory for mass storage.

## 11.10 Creating screenshots of current settings

The save/recall function enables you to save current settings in a file. To document the most important settings for a performed signal generation, you can also save a hardcopy of the current display.

- [Hardcopy settings](#)..... 731
- [Creating a hardcopy of the display](#).....734

### 11.10.1 Hardcopy settings

Access:

- ▶ Press the HCOPY key.

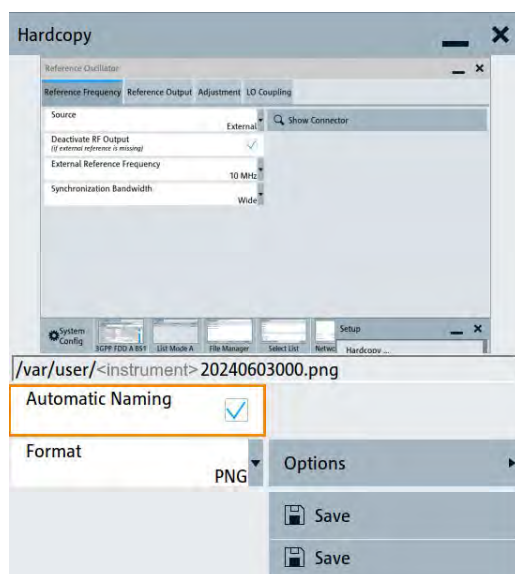

The remote commands required to define these settings are described in [Section 14.14, "HCOPY subsystem"](#), on page 939.

#### Settings:

<a href="#">Automatic Naming</a> .....	732
<a href="#">File</a> .....	732
<a href="#">Format</a> .....	732
<a href="#">Options</a> .....	732
<a href="#">Save</a> .....	732
<a href="#">Hardcopy Options &gt; Common</a> .....	732
L <a href="#">Automatic Naming</a> .....	733
L <a href="#">Format</a> .....	733
L <a href="#">Region</a> .....	733
<a href="#">Hardcopy Options &gt; Automatic Naming</a> .....	733
L <a href="#">Path</a> .....	733

L Clear Path.....	733
L Prefix, Year, Month, Day.....	734
L Current Auto Number.....	734

### Automatic Naming

If enabled, creates the output filenames automatically according to the rules set with the [Hardcopy Options > Automatic Naming](#) settings.

Remote command:

`:HCOPY:FILE[:NAME]:AUTO:STATE` on page 943

### File...

In "Automatic Naming > Off" mode, accesses the standard file select dialog for selecting the filename and folder the hardcopy is stored in.

If you have enabled "Automatic Naming", the instrument displays the automatically generated filename.

Remote command:

`:HCOPY:FILE[:NAME]` on page 941

### Format

Selects the output file format, for example `*.bmp`, `*.jpg`, `*.xpm` and `*.png`.

Remote command:

`:HCOPY:IMAGE:FORMAT` on page 940

`:HCOPY:DEVICE:LANGUAGE` on page 940

### Options...

Accesses [Hardcopy Options](#) dialog.

### Save

Saves a hardcopy of the current display as a file.

Remote command:

`:HCOPY[:EXECUTE]` on page 941

### Hardcopy Options > Common

Access: select "Hardcopy > Options... > Common".

With the provided settings, you can customize the file format and the syntax of the automatically assigned filename.

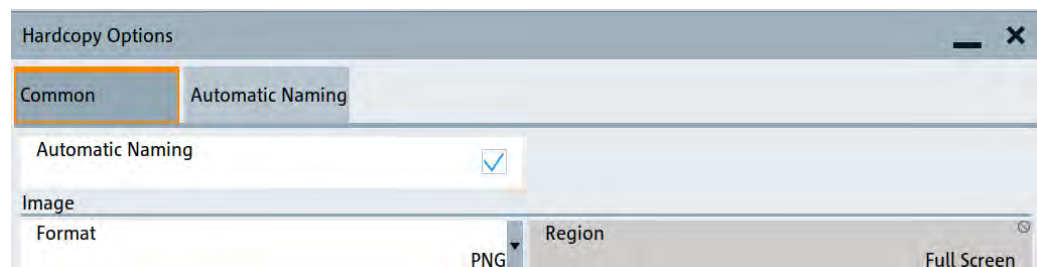

**Automatic Naming** ← **Hardcopy Options** > **Common**

If enabled, creates the output filenames automatically according to the rules set with the [Hardcopy Options > Automatic Naming](#) settings.

Remote command:

`:HCOPY:FILE[:NAME]:AUTO:STATE` on page 943

**Format** ← **Hardcopy Options** > **Common**

Selects the output file format, for example \*.bmp, \*.jpg\*.xpm and \*.png.

Remote command:

`:HCOPY:IMAGE:FORMAT` on page 940

`:HCOPY:DEVICE:LANGUAGE` on page 940

**Region** ← **Hardcopy Options** > **Common**

Displays the snapshot area.

Remote command:

`:HCOPY:REGION` on page 941

**Hardcopy Options > Automatic Naming**

Access: select "Hardcopy > Options... > Automatic Naming".

The screenshot shows the 'Hardcopy Options' dialog box with the 'Automatic Naming' tab selected. The 'Path' field is highlighted with an orange box and contains the text '/var/user'. Below the path field, there is a 'Delete All Image Files In Path' section with a 'Clear Path' button. Underneath, there are four checkboxes: 'Prefix' (checked), 'Year' (checked), 'Month' (checked), and 'Day' (checked). The 'Current Auto Number' field contains '000'. The 'Resulting File Name' field displays '<instrument> 20240603000.png'.

Provided are the following settings:

**Path...** ← **Hardcopy Options** > **Automatic Naming**

Selects the directory.

**Note:** To select the destination path, specify also a filename. Otherwise an error message is displayed and selection is canceled.

Remote command:

`:HCOPY:FILE[:NAME]:AUTO:DIRectory` on page 942

**Clear Path** ← **Hardcopy Options** > **Automatic Naming**

Deletes all image files with extensions \*.bmp, \*.jpg, \*.png and \*.xmp in the directory set for automatic naming.

Before the command is executed, a warning message prompts you to confirm the deletion of the files.

Remote command:

[:HCOPY:FILE\[:NAME\]:AUTO:DIRectory:CLEar](#) on page 942

### **Prefix, Year, Month, Day ← Hardcopy Options > Automatic Naming**

Determines the rules for "Automatic Naming".

Per default, the automatically generated filename is composed of:

<Path>/<Prefix><YYYY><MM><DD><Number>.<Format>, where Y, M and D mean year, month, Day; Number is the [Current Auto Number](#).

You can activate or deactivate each component separately.

The "Resulting filename" indicates the current filename syntax.

Remote command:

[:HCOPY:FILE\[:NAME\]:AUTO\[:FILE\]:PREFIX](#) on page 944

[:HCOPY:FILE\[:NAME\]:AUTO\[:FILE\]:PREFIX:STATE](#) on page 944

[:HCOPY:FILE\[:NAME\]:AUTO\[:FILE\]:YEAR:STATE](#) on page 943

[:HCOPY:FILE\[:NAME\]:AUTO\[:FILE\]:MONTH:STATE](#) on page 943

[:HCOPY:FILE\[:NAME\]:AUTO\[:FILE\]:DAY:STATE](#) on page 943

### **Current Auto Number ← Hardcopy Options > Automatic Naming**

Indicates the number which is used in the automatically generated filename.

**Note:** When initially switching on the instrument, the number is reset to the lowest possible value. Starting with number 0 the output directory is scanned for existing files. As long as files with the same name are existing, the number is increased by 1. The number is automatically set so that the resulting filename is unique within the selected path. The current number is not in the save/recall file but is temporarily stored within the database. At the following save operation, the number is increased.

Remote command:

[:HCOPY:FILE\[:NAME\]:AUTO\[:FILE\]:NUMBER?](#) on page 943

## 11.10.2 Creating a hardcopy of the display

### To create a hardcopy

- ▶ Select "System Config" > "Setup" > "User Interface" > "Hardcopy".

Alternatively, you can use the following controls to create a hardcopy quickly:

- Press the [HCOPY] key.
- On the screen, select context-sensitive menu >  (print).
- On an external keyboard, press the [Print] key.
- Assign the hardcopy function to the [User] key.

See [Section 12.4.2, "How to assign actions to the \[USER\] key"](#), on page 767.

The R&S SMW200A creates a snapshot of the screen and opens the "Hardcopy" dialog for saving it in a file.

**To configure and save the hardcopy**

1. To define the output format, select "Format" > "JPG".
2. To enable the instrument to create output filenames, select "Automatic Naming" > "On".
3. Select "Options ...".
4. In the "Hardcopy Options" dialog:
  - a) To change the default storage directory, select "Automatic Naming Settings" > "Path".
  - b) Define a path and a filename.  
For example, select the default directory `/var/user`.
  - c) If necessary, modify the parameters in the "Automatic Naming Settings".
  - d) Close the "Hardcopy Options" dialog.
5. In the "Hardcopy" dialog, select "Save".  
The instrument saves a hardcopy of the current instrument display as a `*.jpg` file.  
Also, creates the filename automatically.

**To export a hardcopy**

1. Connect the instrument to the LAN.
2. Transfer the file to a remote computer  
See [Section 11.9, "Transferring files from and to the instrument"](#), on page 725.
3. On the remote computer, select the file.

## 12 General instrument functions

The general instrument functions include basic instrument settings, regardless of the selected operating mode and measurement. Some of these settings like screen display and peripherals are initially configured at the setup of the instrument, according to personal preferences and requirements. However, you can individually adjust the settings at any time, for example, for specific applications.

The following special functions help you in service and basic system configuration:

- [Section 12.1, "Customizing the user interface"](#), on page 736  
Allows you to adjust the display and keyboard language settings.
- [Section 12.2, "Configuring local and global connectors"](#), on page 742  
Allows you to map internal or external signals to the multipurpose connectors.
- [Section 12.3, "Checking parameters and dependencies"](#), on page 761  
Allows you to check for interdependencies between parameters and settings.
- [Section 12.4, "Organizing frequently used settings as favorites"](#), on page 763  
Enables you to group user-defined settings in a favorites list or to assign actions to the [USER] as quick access for later retrieval.
- [Section 12.5, "Managing licenses and license keys"](#), on page 770  
If you have purchased an additional option for the R&S SMW200A, you can enable it using a license key.
- [Section 11.2, "Restoring an instrument configuration"](#), on page 702  
At any time, you can restore a default configuration to start a measurement at a defined instrument state, or set the instrument to factory preset.
- [Section 17.3, "Performing maintenance tasks"](#), on page 1357  
Special functions like calibration routines and selftests put your instrument to an initial state.
- [Section 12.7, "Using the security settings"](#), on page 794  
Special security and protection functions protect your instrument from unauthorized use or activate specific test routines.

### 12.1 Customizing the user interface

The R&S SMW200A provides basic alignments of instrument settings regarding the user interface, that means the touch panel (screen), the appearance of the displayed dialogs and graphics, and an external keyboard.

#### Dialog snapshots

The R&S SMW200A enables you to disable the snapshots of dialogs in the taskbar and replaces dialogs with test. For information on how to deactivate the snapshot preview, see [Section 12.1.2, "Appearance settings"](#), on page 739.



### Start / stop display update

The operating system of the R&S SMW200A refreshes the displayed settings by default in almost real-time, to keep the display updated with the internally used values. However, you can turn off this function to reduce settling times when the instrument is remote controlled.



We recommend that you switch off the display update for optimum sweep performance with short dwell times and for fast settling times.

Consider that in this case the displayed values can differ from the operated values.

In detail described in the following paragraphs, you can:

- Set display and keyboard language, see [Section 12.1.1, "Display and keyboard settings"](#), on page 737
- Customize the GUI appearance, see:
  - [Dialog snapshots](#)
  - [Section 12.1.2, "Appearance settings"](#), on page 739
- Set date and time for the system clock, see [Section 17.3.1, "Date and time"](#), on page 1358
- Configure and activate a [Screen Saver](#)
- Deactivate display update to improve performance, see [Section 12.1.3, "Display update settings"](#), on page 739
- Determine the state of the RF signal, and the level display in the status bar when you turn on the R&S SMW200A, see [Section 12.1.4, "Defining the RF signal state on power on"](#), on page 740.

## 12.1.1 Display and keyboard settings

Access:

1. Select "System Config > Setup > User Interface > Display".

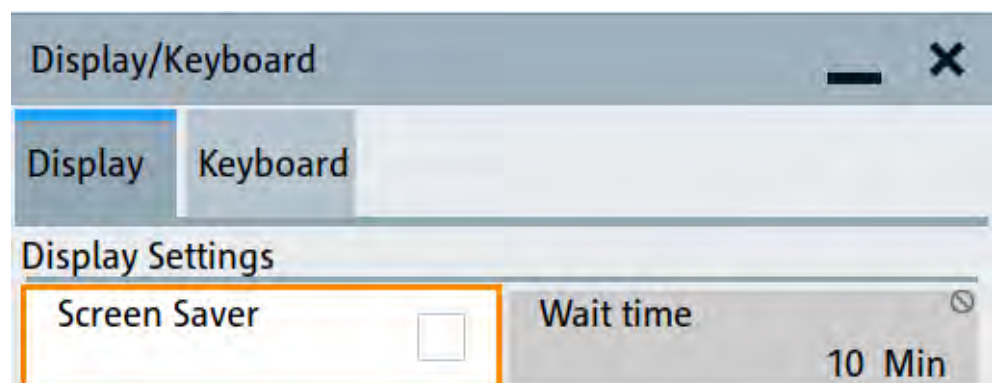

2. Select "Keyboard".

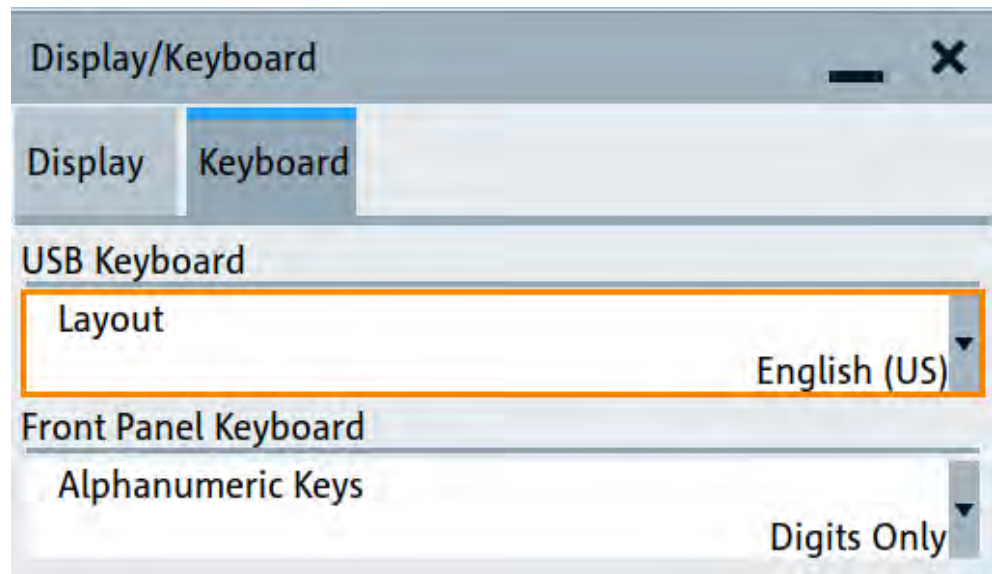

In the "Display" and "Keyboard" dialogs, you can enable the screen saver function and configure the language for the key assignment of an external keyboard and the keypad.

The remote commands required to configure the display and keyboard are described in [Section 14.12, "DISPlay subsystem"](#), on page 933 and [Section 14.15, "KBOard subsystem"](#), on page 944.

<a href="#">Screen Saver</a> .....	738
<a href="#">Wait Time</a> .....	738
<a href="#">Layout</a> .....	738
<a href="#">Alphanumeric Keys</a> .....	739

### Screen Saver

Activates the screensaver.

If activated, the display including backlight is switched off after the selected [Wait Time](#) elapses and if no entries via touch panel, front panel, external mouse, or external keyboard are made

Remote command:

[:DISPlay:PSAVe\[:STATe\]](#) on page 934

### Wait Time

Enters the idle time that must elapse before the display lamp is shut off when no entries are made.

Remote command:

[:DISPlay:PSAVe:HOLDoff](#) on page 934

### Layout

Selects the language of an external keyboard connected over USB. The function assigns the corresponding keys automatically.

Remote command:

:KBOard:LAYout on page 944

### Alphanumeric Keys

Selects the layout of the numeric keypad on the front panel.

"Digits Only" Assigns only numeric keys.

"Digits and Letters" Enables numeric and alphanumeric keys.

Remote command:

:FPANel:KEYBoard:LAYout on page 944

## 12.1.2 Appearance settings

Access:

- ▶ Select "System Config" > "Setup" > "User Interface" > "Appearance".

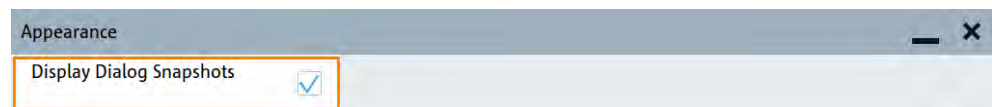

In this dialog, you can set inactive dialog opaque and enable the display of dialog snapshots.

[Display Dialog Snapshots](#)..... 739

### Display Dialog Snapshots

Displays thumbnails of open dialogs in the task bar.

## 12.1.3 Display update settings

Access:

- ▶ Select "System Config > Setup > User Interface > Start/Stop Display Update".

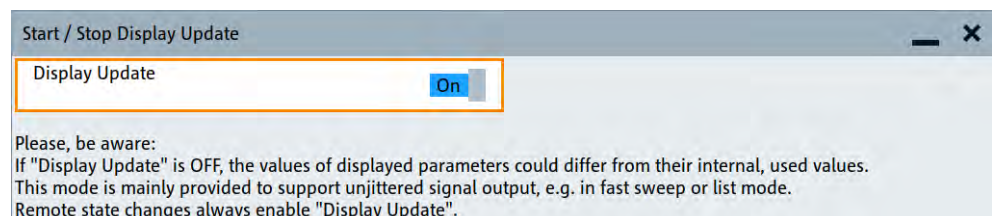

This dialog enables you, to deactivate updating the display.

The remote command to switch off the display update is described in [Section 14.12, "DISPlay subsystem"](#), on page 933.

**Display Update is**

Disables the automatic refreshing of the displayed values.

Remote command:

[:DISPlay:UPDate\[:STATe\]](#) on page 935

**12.1.4 Defining the RF signal state on power on**

As additional functions for the level settings, you can determine the state of the RF signal, and the level display in the status bar when you turn on the R&S SMW200A.

**Power-On/EMF settings**

Access:

- ▶ Select "RF" > "RF Level" > "Power-On / EMF".

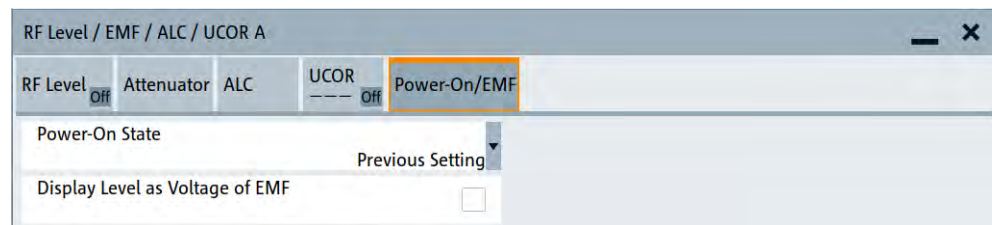

The "Power-On/EMF" dialog contains all settings for configuring the power-on behavior and the level display.

**Settings:**

<a href="#">Power-On State</a> .....	740
<a href="#">Display Level as Voltage of EMF</a> .....	740

**Power-On State**

Determines the RF signal output state when the instrument is switched on.

You can disable the RF output signal in general, or start it in the same state as it had been when it was switched off.

Remote command:

[:OUTPut<hw>\[:STATe\]:PON](#) on page 946

**Display Level as Voltage of EMF**

Activates display of the signal level as voltage of the EMF (no-load voltage).

If disabled, the level is displayed as a voltage over a 50 Ohm load.

**Note:**

The setting is not affected by an instrument preset ([PRESET] key or \*RST) and the "Save/Recall" function. It is reset only by factory preset.

Remote command:

[\[:SOURce<hw>\]:POWer:EMF:STATe](#) on page 1270

## 12.1.5 How to set the initial instrument settings

This section describes how to set up the R&S SMW200A initially.

### 12.1.5.1 Setting the keyboard language

You can select the language of the external keyboard connected to the instrument.

#### To adjust the keyboard settings

1. Press the [SETUP] key.
2. Select "User Interface > Keyboard".

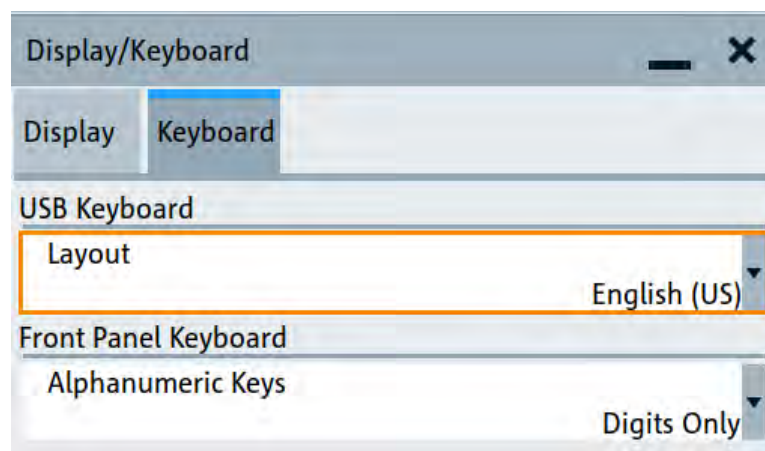

3. Select the "Layout".

The dialog closes and the changes take effect immediately.

### 12.1.5.2 Setting the screen saver

You can enable a screen saver that automatically turns off the display after a user-defined period of time. The screen saver is activated if no settings are made on the touch screen, or via keys or the rotary knob during the selected wait time.

#### To activate the screen saver

1. Press the [SETUP] key.
2. Select "User Interface > Display"
3. Activate the "Screen Saver".

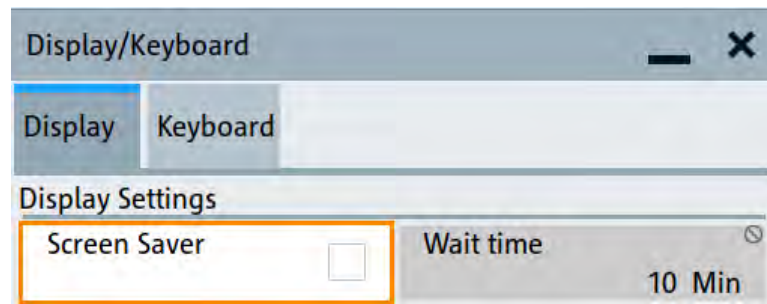

4. Define the "Wait Time" in minutes.  
The instrument turns off the display after the defined period of time.
5. To reactivate the display, tap the screen or press any key on the front panel.

#### To deactivate the screen saver

1. Press the [SETUP] key.
2. Select "User Interface > Display"
3. Disable the "Screen Saver" state.

#### 12.1.5.3 Adjusting appearance of the user interface

You can disable the snapshot preview of dialog in the taskbar .

1. Press the [SETUP] key.
2. Select "User Interface > Appearance".
3. If necessary, enable "Display Dialog Snapshots".

The changes take effect immediately.

## 12.2 Configuring local and global connectors

The R&S SMW200A provides six "USER" connectors that you can use for input or output of multi-purpose baseband signals or RF signals.

Grouped according to their impact, the R&S SMW200A provides the following connector types:

- [Section 12.2.2.1, "Global connectors"](#), on page 743
- [Section 12.2.2.2, "Baseband local connectors"](#), on page 745

Grouped according to their impact on the baseband or on the RF signal, the same connectors are divided into:

- [Section 12.2.3, "Trigger marker clock settings"](#), on page 748
- [Section 12.2.4, "RF connectors settings"](#), on page 751

• <a href="#">Required options</a> .....	743
• <a href="#">About local and global connectors</a> .....	743
• <a href="#">Trigger marker clock settings</a> .....	748
• <a href="#">RF connectors settings</a> .....	751
• <a href="#">Global connectors settings</a> .....	752
• <a href="#">Local connectors settings</a> .....	757
• <a href="#">Routing signals to the connectors</a> .....	760

## 12.2.1 Required options

The R&S SMW200A always provides six "USER" interfaces with the standard or wide-band baseband generator (R&S SMW-B10/-B9). These interfaces do not require additional options.

Required for the support and configuration of the local T/M/C connectors, 6 with R&S SMW-B10 and 4 with R&S SMW-B9.

## 12.2.2 About local and global connectors

### Signal to connector mapping

As described in [Section 5.5.1, "About common baseband characteristics"](#), on page 224, the R&S SMW200A uses several internally generated and externally supplied signals. To handle these signals and more than two baseband signals, the R&S SMW200A introduces the concept of signal to connector mapping. The available signals are not dedicated to a particular connector but can be mapped to one or more globally shared USER or local T/M/C connectors.

The signal mapping and the polarity, the trigger threshold, and the input impedance of the input connectors are configurable parameters. The connectors settings are grouped in the [Global connectors settings](#) and [Local connectors settings](#) dialogs.

How to: [Section 12.2.7, "Routing signals to the connectors"](#), on page 760

### 12.2.2.1 Global connectors

The R&S SMW200A is equipped with USER x interfaces which can be freely assigned a selection of signals and which can be configured as both inputs and outputs.

A common threshold and input impedance is effective for all trigger and clock signal inputs provided at the USER connectors. The settings influence the custom digital modulations, the generation of waveforms or multicarrier signals, and all digital standards.

Also, the R&S SMW200A is equipped with two INST TRIG x connectors. The instrument trigger setting influences all sweeps and is effective in the List mode.

See [Section 8.10, "Varying the RF signal in list or sweep mode"](#), on page 509.

The [Table 12-1](#) gives an overview of the signals that can be applied to and output at the USER connector.

**Table 12-1: Mapping control signals to the USER x connectors**

Connector	Direction	Assigned Signal	Remark
USER 1, 2, 3	Input	"Global Trigger 1/2" "Global Clock 1/2" "Global Next Segment 1/2" <sup>1)</sup>	<sup>1)</sup> Requires R&S SMW-B10
	Output	"Baseband <BB> Marker 1/2/3" <sup>2)</sup> "Always 0/1"	<p><b>Standard baseband</b></p> <p><sup>2)</sup> &lt;BB&gt; represents basebands:</p> <ul style="list-style-type: none"> <li>• &lt;BB&gt; = A/B/C/D In "System Configuration &gt; Baseband Source &gt; Separate"</li> <li>• &lt;BB&gt; is omitted In "System Configuration &gt; Baseband Source &gt; Coupled"</li> <li>• &lt;BB&gt; = 1/2/3/4 In "System Configuration &gt; Baseband Source &gt; Coupled per Entity"</li> </ul> <p><b>Wideband baseband</b></p> <p><sup>2)</sup> &lt;BB&gt; represents basebands:</p> <ul style="list-style-type: none"> <li>• &lt;BB&gt; = A/B In 2x1x1 configuration with "System Configuration &gt; Baseband Source &gt; Separate" and &lt;BB&gt; = A in all other configuration</li> <li>• &lt;BB&gt; is omitted In "System Configuration &gt; Baseband Source &gt; Coupled"</li> <li>• &lt;BB&gt; = 1 In "System Configuration &gt; Baseband Source &gt; Coupled per Entity"</li> </ul>
USER 4, 5, 6	Input	"Global Trigger 1/2" "Global Clock 1/2" "Global Next Segment 1/2" <sup>1)</sup> "Pulse In A/B" <sup>3)</sup>	<sup>3)</sup> In an instrument equipped with 1 RF path, the name of the signal is "Pulse In"
	Output	"Baseband <BB> Marker 1/2/3" <sup>2)</sup> "Signal Valid A/B" <sup>4)</sup> "Signal Valid A/B Neg" <sup>4)</sup> "Pulse Out A/B" <sup>4)</sup> "Pulse Sync A/B" <sup>4)</sup> "Pulse Video A/B" <sup>4)</sup> "Always 0/1"	<sup>4)</sup> In an instrument equipped with 1 RF path, the names of the signals are "Signal Valid", "Pulse Gen" and "Pulse Sync"
USER 4, 5	Output	"REG Trigger A/B"	Requires "System Configuration > Mode > Radar Echo Generation (REG)".
USER 6	Input	"Feedback"	-
	Output	"Manual Trigger"	-



### 12.2.2.2 Baseband local connectors

Apart from the multipurpose global USER connectors, each baseband coder board is equipped with local T/M/C connectors.

The [Table 12-4](#) gives an overview of the signals that can be applied and output at the T/M/C connectors.

#### Option: R&S SMW-B9

**Table 12-2: Control signals mapped to T/M/C connectors (System Configuration > BB Sources = Separate/Coupled per Entity)**

Connector shared between "Baseband A/C"	Connector shared between "Baseband B/D"	Direction	Assigned Signal
T/M/C 1	T/M/C 3	Output	"Symbol Clock <BB>" <sup>1)</sup> "Baseband <BB> Marker 1/2"
T/M 2	T/M 4	Output	"Baseband <BB> Marker 1/2" <sup>1)</sup> <BB> represents basebands: <ul style="list-style-type: none"> <li>• &lt;BB&gt; = A or B in "System Configuration &gt; Baseband Source &gt; Separate"</li> <li>• &lt;BB&gt; = 1 or 2 in "System Configuration &gt; Baseband Source &gt; Coupled per Entity"</li> </ul>
T/M 2	T/M 4	Input	"Feedback"

**Table 12-3: Control signals mapped to T/M/C connectors (System Configuration > BB Sources = Coupled)**

Connector	Direction	Assigned Signal
T/M/C 1	Output	"Symbol Clock" "Baseband Marker 1"
T/M 2	Output	"Baseband Marker 2"
T/M 2	Input	"Feedback"
T/M/C 3	Output	"Symbol Clock"
T/M 4	Input	"Feedback"

#### Option: R&S SMW-B10

**Table 12-4: Mapping control signals to the local T/M/C connectors (System Configuration > BB Sources = Separate/Coupled per Entity)**

Connector shared between "Baseband A/C"	Connector shared between "Baseband B/D"	Direction	Assigned Signal
T/M/C 1	T/M/C 4	Input	"Trigger" "Clock"
T/M 2	T/M 5	Input	"Data"

Connector shared between "Baseband A/C"	Connector shared between "Baseband B/D"	Direction	Assigned Signal
T/M 2, 3	T/M 5, 6	Input	"Trigger"
T/M 3	T/M 6	Input	"Feedback"
T/M/(C) 1, 2, 3	T/M/(C) 4, 5, 6	Output	"Baseband <BB> Marker 1/2/3" <sup>1)</sup> "Symbol Clock <BB>" <sup>1)</sup> "Lev Att <BB>" <sup>1)</sup> "Burst Gate <BB>" <sup>1)</sup> "Hop <BB>" <sup>1)</sup> "CW/Mod <BB>" <sup>1)</sup> "Triggered <BB>" <sup>1)</sup> <sup>1)</sup> <BB> represents basebands: <ul style="list-style-type: none"> <li>• &lt;BB&gt; = A/C or B/D in "System Configuration &gt; Baseband Source &gt; Separate"</li> <li>• &lt;BB&gt; = 1/3 or 2/4 in "System Configuration &gt; Baseband Source &gt; Coupled per Entity"</li> </ul>

**Table 12-5: Mapping control signals to the local T/M/C connectors (System Configuration > BB Sources = Coupled)**

Connector	Direction	Assigned Signal
T/M/(C) 1, 2, 3	Same selection as for "BB Sources = Separate/Coupled per Entity", see <a href="#">Table 12-4</a> .	-
T/M/(C) 4, 5	Output	"Symbol Clock"
T/M 6	Input	"Feedback"

### 12.2.2.3 Trigger marker clock and RF connectors

The [Trigger marker clock settings](#) and [RF connectors settings](#) dialogs provide an overview of the current mapping of the logical signals to the corresponding connectors. The dialogs are summary representation of related settings, as configured with the [Global connectors settings](#) and [Local connectors settings](#) settings.

### 12.2.2.4 Status indicators

#### Connector status LEDs

A dedicated LED indicates the connector status:

- ● green: an input connector
- ● yellow: an output connector
- ● no light / gray: the connector is not active

#### TMC block

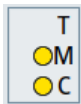

For a quick overview of the control signal sources, the block diagram provides the "TMC" block on the left side of the "Baseband" block.

If the baseband generator is enabled, a dedicated LED indicates the status of the control signal:

- ● Green: Uses an external signal.
- ● Yellow: Uses the signal as an output signal.

At the upper left corner of the "TMC" block, the letters "A" or "B" indicate that the control signal source is an internal signal from the other baseband signal path. The icon  indicates coupled common trigger settings for both paths.

### TELPV block

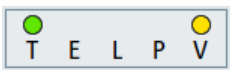

For a quick overview of the control signal sources, the block diagram provides the "TELPV" block next to the "RF" block.

If the "RF" block is enabled, a dedicated LED indicates the status of the control signal:

- ● Green: Uses an external signal.
- ● Yellow: Uses the signal as an output signal.

If enabled, the "TELPV" block also displays the status of the signal valid signal ("V") and the pulse signal ("P").

#### 12.2.2.5 Internal resources for the trigger, marker, clock and control signals

Apparently, not all trigger, marker, clock and control signals can be output or input at the same time. The [Figure 12-1](#) is a graphical representation of the available internal resources concerning the trigger, marker, clock and control signals. The diagram focuses on the internal signals routing rather than showing the exact input and output signals.

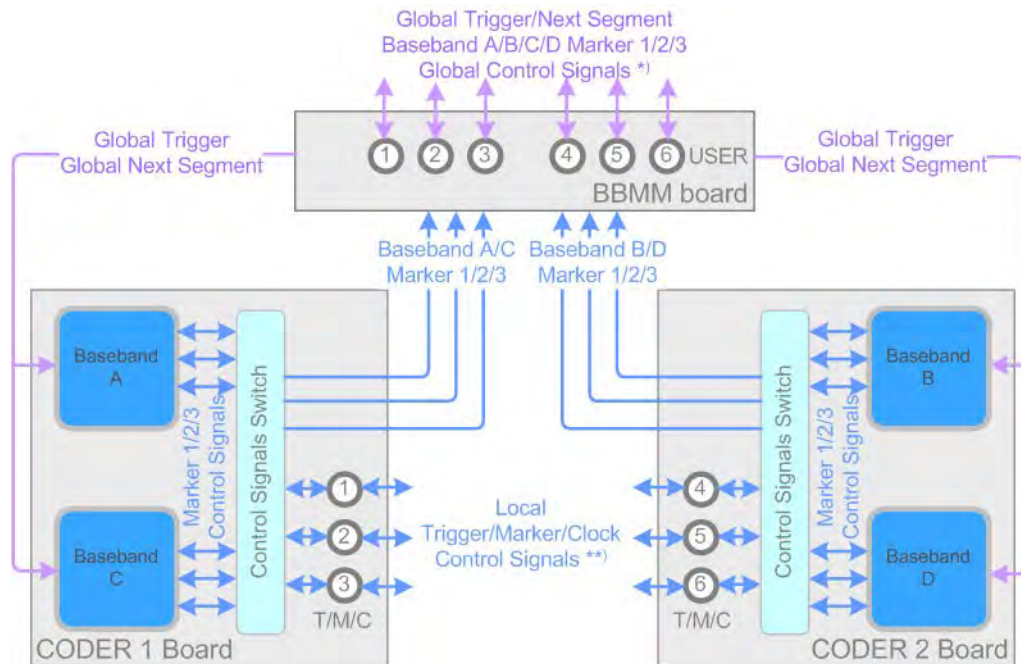

**Figure 12-1: Internal resources for the marker and trigger signals**

\* = Pulse In/Out A/B, Sync A/B, Signal Valid A/B

\*\* = Lev Att, Burst Gate, CW/Mod, Hop, Triggered

The baseband couple A/C is implemented on the same hardware, CODER board, and hence share the T/M/C1/2/3 connectors. The baseband B/D couple share the T/M/C4/5/6 connectors.

### 12.2.3 Trigger marker clock settings

Access:

1. Select one of the following:
  - In the "Block Diagram", select the **TMC block** on the left side of the "Baseband" blocks.
  - Select "Baseband" > "Trigger Marker Clock".

The "Trigger Marker Clock" gives an overview of the current mapping of the logical signals to the connectors, as configured in the **Global Connectors** and **Local Connectors** dialogs. Clicking the connector name directly accesses the related connector settings.

The dialog consists of several tabs, each tab corresponds to one of the available basebands.

Trigger / Marker / Clock

Baseband A Baseband B

	Logical Signal	Connector	Show
Trigger Source	Internal		
Clock Source	Internal		
Clock Output		T/M/C 1	🔍...
Marker 1	On/Off Ratio	User 1	🔍...
Marker 2	On/Off Ratio	User 2, T/M 2	🔍...
Marker 3	On/Off Ratio		

Local Connectors ▶

Global Connectors ▶

Diagram Legend

- T = Trigger
- M = Marker
- C = Clock
- 🟢 = Signal Source is external
- 🟡 = Signal is available at Output Connector

- Use the built-in **Show Connector** function to display the physical location of the selected connector.

A blinking LED on the front/rear panel indicates the selected connector, too.

Show Connectors

Front  Rear

The image shows the rear panel of the R&S SMW200A instrument. The panel is densely packed with various connectors, including BNC connectors, SMA connectors, and a LAN port. A blue box highlights the T/M/C 1 connector, which is a BNC connector. The 'Rear' tab in the 'Show Connectors' window is selected, indicated by a blue eye icon.

The eye icon  in the tab header indicates the panel (front, rear or both) the selected connector is at.

### 12.2.3.1 Overview table

#### Common to All Basebands

To enable simultaneous signal generation in all basebands, the R&S SMW200A couples the trigger settings in the available basebands in any instrument's configuration involving signal routing with signal addition. For example, in MIMO configuration, routing and summing of basebands or of streams.

The icon  indicates that common trigger settings are applied.

You can access and configure the common trigger source and trigger mode settings in any of the basebands. An arm or a restart trigger event applies to all basebands, too. You can still apply different delay to each of the triggers individually.

#### Logical Signal

Displays the logical signal, as configured in the tabs "Trigger In", "Marker" or "Clock" of the corresponding digital standard, see for example [Section 5.5.2.1, "Trigger settings"](#), on page 252.

#### Connector

Displays the assigned connector:

- As selected in the [Global Connectors](#) dialog.
- As selected in the [Local Connectors](#) dialog.
- Dedicated RF connectors, like "LO In/Out", "INST TRIG x".



#### Show Connector

Accesses a dialog that displays the physical location of the selected connector on the front/rear panel of the instrument.

A blinking LED on the front/rear panel indicates the selected connector, too (see [Section 12.2.2.4, "Status indicators"](#), on page 746).

### 12.2.3.2 Local and global connectors settings

Opens a dialog to configure local connectors or global connectors.

The button is available in the following dialogs or tabs:

- "Trigger / Marker / Clock" dialog that is accessible via the "TMC" block in the block diagram.
- "Trigger In", "Marker" and "Clock" tabs of baseband signal configuration dialogs that you can open via the "Baseband" block in the block diagram. These tabs are available, for example, for "ARB" baseband signals.



See also [Section 12.2, "Configuring local and global connectors"](#), on page 742.

## 12.2.4 RF connectors settings

Access:

1. In the control signal block next to the "RF" block, select [TELPV block](#).

The "RF Connectors" dialog gives an overview of the mapping of the logical signals to the connectors; the displayed connectors depend on the installed options. The signal assignment to the dedicated RF connectors, for example LO In/Out or INST TRIG x, is fixed.

The dialog has a separate tab for each of the RF blocks. You can change the signal to connector mapping of the global connectors in the [Global connectors settings](#) dialog.

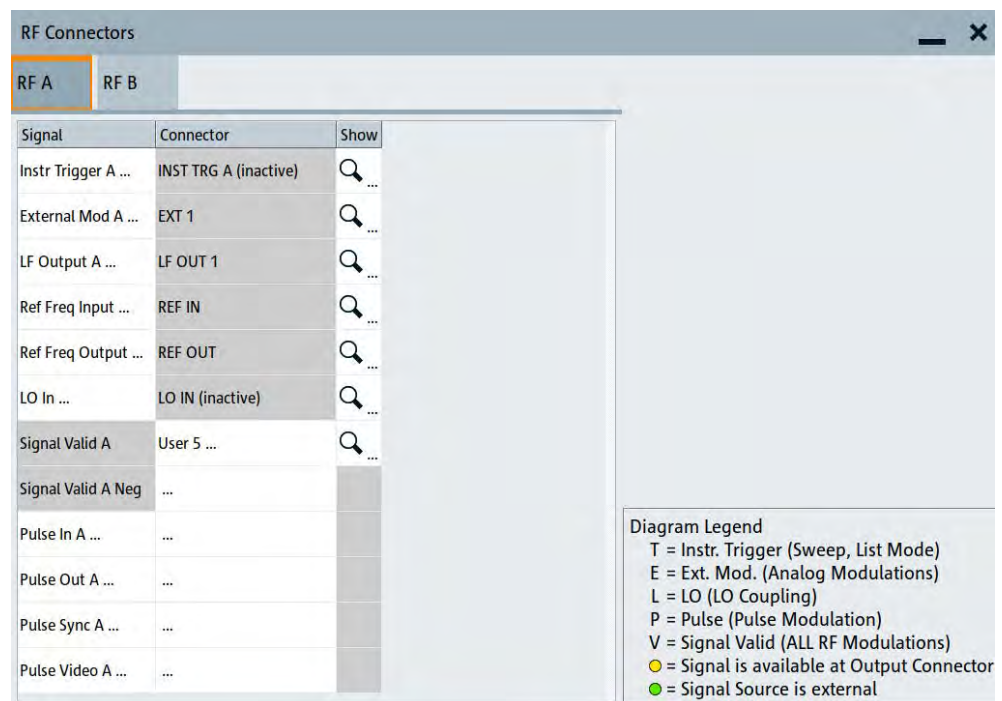

2. Select the signal type ("Signal") to open the dialog with related signal settings.
3. Use the built-in [Show Connector](#) function to display the physical location of the selected connector.

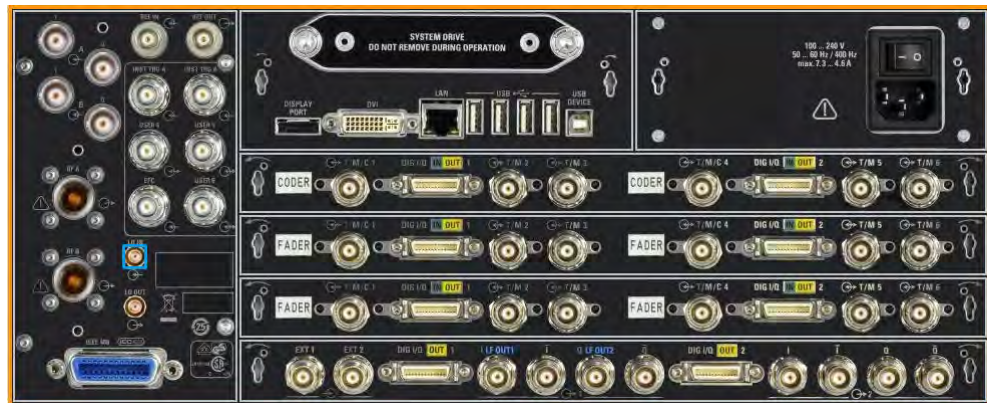

The eye icon  in the tab header indicates, if the connector is on the front panel or rear panel. A blinking blue rectangle marks the connector or multiple connectors, if supported.

**Settings:**

[Signal](#)..... 752  
[Connector](#).....752  
[Show Connector](#).....752

**Signal**

Opens the dialog with the corresponding settings.

**Connector**

Displays the assigned connector:

- As selected in the [Global Connectors](#) dialog.
- As selected in the [Local Connectors](#) dialog.
- Dedicated RF connectors, like "LO In/Out", "INST TRIG x".



**Show Connector**

Accesses a dialog that displays the physical location of the selected connector on the front/rear panel of the instrument.

A blinking LED on the front/rear panel indicates the selected connector, too (see [Section 12.2.2.4, "Status indicators"](#), on page 746).

**12.2.5 Global connectors settings**

Access:

1. To access global connector settings via the signal control blocks of the block diagram, select the [TMC block](#).
2. In the opening dialogs, try one of the following:
  - Select "Connector" > "USER x" to select a global connector "USER x".
  - Select "Global Connectors".



3. To access global connector settings via the baseband block of the block diagram, select one of the following:
  - Select "Baseband" > "ARB"/"Custom Digital Modulation" > "Trigger In" > "Global Connectors".
  - Select the tabs "Trigger In", "Marker" or "Clock" of the corresponding digital standard.
4.
  - Select "Baseband > Custom Digital Modulation > Trigger In > Global Connector Settings" or respectively the "Trigger In", "Marker" or "Clock" tab of the corresponding digital standard.
  - In the "Block Diagram", select the "T/E/P/V" status LEDs to access the "RF Connectors" dialog. Select a global connector "USER x".

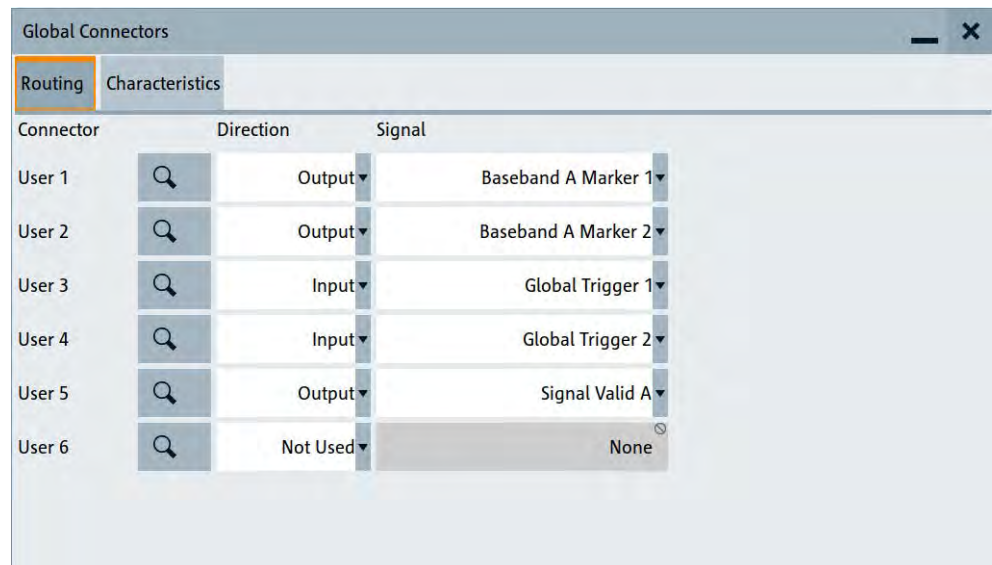

The "Global Connectors" dialog provides settings to configure the signal to connector routing and the physical characteristics of the input connectors for trigger, clock and control signals.

5. Select "Show Connector" to display the physical location of the selected connector. If active, the LED next to connector is green or yellow. See also "[Connector status LEDs](#)" on page 746.

**Settings:**

Show Connector.....	754
Direction.....	754
Signal.....	754
Execute Trigger.....	756
Threshold USER1-3 Input.....	756
Threshold USER4-6 Input/Threshold Pulse Input.....	756
Impedance Clock/Trigger Input.....	757
Clock Input Slope.....	757
Trigger Input Slope.....	757

**Show Connector**

Accesses a dialog that displays the physical location of the selected connector on the front/rear panel of the instrument.

A blinking LED on the front/rear panel indicates the selected connector, too (see [Section 12.2.2.4, "Status indicators"](#), on page 746).

**Direction**

Sets the direction of the signal at the connector that can be input or an output.

If you do not use the connector, select "Not Used".

Remote command:

`[ :SOURce ] : INPut : USER<ch> : DIRection` on page 1009

`: OUTPut : USER<ch> : DIRection` on page 1009

**Signal**

Determines the control signal that is input or output at the selected connector. Whether the connector is used as an input or an output is selected by the parameter [Direction](#).

The [Table 12-1](#) lists the available control signals.

"Global Trigger 1/2"

Input for triggering custom digital modulations, digital standards and ARB. A trigger event affects the signal generation in all basebands for which the "Global Trigger" signal is enabled.

"Global Clock 1/2"

Input for external clock signal for synchronizing the internal clocks in all basebands to an externally applied clock signal. The active edge can be configured.

"Global Next Segment 1/2"

Input next segment for triggering of multi-segment waveform files (see [Section 5.10, "Generating multi-segment waveform files"](#), on page 360).

"Baseband <BB> Marker 1/2/3"

Marker signal output for triggering and control of external devices with user-definable marker signals.

Where <BB> (A/B/C/D or 1/2/3/4) indicates the baseband that the signal is related to.

Available marker signals depend on the system configuration, see [Table 12-1](#).

"Feedback"	Input for global feedback signal, required for 3GPP HSUPA HARQ Feedback, 3GPP Dynamic Power Control or EUTRA/LTE Closed Loop BS tests.
"Pulse In A/B"	Input of external pulse signal or input of external trigger/gate signal for internal pulse generator (see <a href="#">Section 8.11.4.3, "Pulse generator settings"</a> , on page 564).
"Pulse Out A/B"	Output of the internal pulse signal generated by the internal pulse generator (see <a href="#">Section 8.11.4.3, "Pulse generator settings"</a> , on page 564).
"Signal Valid A/B"	Automatically generated output signal that marks the valid signal times (valid level and frequency) for all analog modulations. The signal is indicated by the "T/E/P/V" status LEDs near to the "RF" block. See also <a href="#">Section 8.11.4, "Modulation settings"</a> , on page 557.
"Signal Valid A/B Neg"	Inverted version "Signal Valid A/B"; the output signal is low during the valid signal times.
"Sync A/B"	Output for internal Sync signals for pulse modulation. Sync signals are generated at the beginning of a list or a sweep and used for synchronization to other instruments. See also <a href="#">Section 8.10, "Varying the RF signal in list or sweep mode"</a> , on page 509).
"Video A/B"	Output of the external or internal pulse modulation signal (video signal). See also <a href="#">Section 8.11.4.1, "Pulse modulation settings"</a> , on page 557.
"REG trigger A/B"	Automatically generated output signal used for latency calibration in the Radar Echo Generation (REG) mode. See user manual R&S SMW-K78 Radar Echo Generation.
"Baseband Sync Out/Baseband Sync In"	<ul style="list-style-type: none"> <li>"Baseband Sync Out" One or more outputs of a dedicated synchronization (and trigger) signal that has to be fed into the secondary instruments.</li> <li>"Baseband Sync In" In the secondary instruments, at most one input for the synchronization (and trigger) signal. Can be assigned to any global connector.</li> </ul> <p>See also <a href="#">Section 10.3.1, "Connecting multiple instruments in primary-secondary instrument mode"</a>, on page 664.</p>
"Always 0"/"Always 1"	Control signal with low or high level.

**"Manual Trigger"**

Output of a short pulse signal that can serve as a common external trigger signal for triggering of several R&S SMW200A.

See [Example "Triggering several R&S SMW200A instruments simultaneously"](#) on page 678.

**"BER Data"/"BER Clock"/"BER Data Enable"/"BER Restart"**

Option: R&S SMW-K80

Input signals for BERT/BLER testing.

See user manual R&S SMW-K80 Bit Error Rate Tester.

**"BER TestGen Data"/"BER TestGen Clock"/"BER TestGen Data Enable"/"BER TestGen Restart"**

Option: R&S SMW-K80

Output signals for BERT/BLER testing.

See user manual R&S SMW-K80 Bit Error Rate Tester.

**"External Restart REG Trigger A/B"**

Option: R&S SMW-K78

External restart trigger signals for radar echo generator (REG).

See user manual R&S SMW-K78 Radar Echo Generation.

**"None"**

No signal is assigned to the connector.

Remote command:

[\[:SOURce\]:INPut:USER<ch>:SIGNa1](#) on page 1011

[:OUTPut:USER<ch>:SIGNa1](#) on page 1012

**Execute Trigger**

If "User 6" > "Direction" > "Output" and "Signal" > "Manual Trigger", generates a short pulse signal and outputs it at the USER 6 connector.

The signal can serve as a common external trigger signal for triggering of several R&S SMW200A, see [Example "Triggering several R&S SMW200A instruments simultaneously"](#) on page 678.

Remote command:

[:OUTPut:USER<ch>:TRIGger\[:IMMediate\]](#) on page 1013

**Threshold USER1-3 Input**

Sets the high/low threshold in volts for the signal at the USER1-3 connectors.

The input signal is defined with the parameter [Signal](#). The same threshold applies for all 3 connectors and any input signal.

Remote command:

[\[:SOURce\]:INPut:USER:TRIGger:LEVel](#) on page 1013

[\[:SOURce\]:INPut:USER:CLOCK:LEVel](#) on page 1013

**Threshold USER4-6 Input/Threshold Pulse Input**

Sets the high/low threshold in volts for the signal at the USER4-6 connectors.

The input signal is defined with the parameter [Signal](#). The same threshold applies for all 3 connectors and any input signal (e.g. external pulse modulation or trigger signal).

Remote command:

[\[:SOURce\]:INPut:USER:PULM:LEVel](#) on page 1014

**Impedance Clock/Trigger Input**

Selects the input impedance for the external trigger/clock inputs.

Set the value to 1 k $\Omega$ /GND for high clock rates.

Remote command:

[ :SOURce ] : INPut : USER : TRIGger : IMPedance on page 1014

[ :SOURce ] : INPut : USER : CLOCk : IMPedance on page 1014

**Clock Input Slope**

Sets the polarity of the active slope of an externally applied clock signal.

Remote command:

[ :SOURce ] : INPut : USER : CLOCk : SLOPe on page 1014

**Trigger Input Slope**

Sets the polarity of the active slope of an applied instrument trigger.

Remote command:

[ :SOURce ] : INPut : USER : TRIGger : SLOPe on page 1014

**12.2.6 Local connectors settings**

Access:

- You have several options to access the settings:
  - In the block diagram, select the "T"/"M"/"C" status LEDs. See ["TMC block"](#) on page 746.
    - Select a local T/M/C connector or
    - Select "Local Connector Settings".
  - Select "Baseband > Custom Digital Modulation > Trigger In > Local Connector Settings" or respectively the "Trigger In", "Marker" or "Clock" tab of the corresponding digital standard.

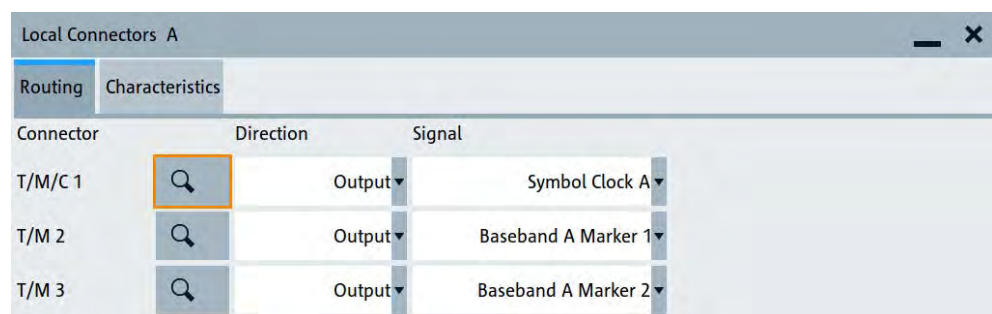

The "Local Connectors" dialog provides settings to route the signals to the local connectors and to determine the physical characteristics of the input connectors for trigger, clock and marker signals.

If you use coupled sources ("System Configuration" > "BB Sources" > "Coupled Sources"), the dialog displays the settings of all T/M/C connectors.

- Select "Show Connector" to display the physical location of the selected connector.

If active, the LED next to connector is green or yellow. See also "[Connector status LEDs](#)" on page 746.

### Settings:

Connector.....	758
Show Connector.....	758
Direction.....	758
Signal.....	758
Threshold Clock/Trigger Input.....	759
Impedance Clock/Trigger Input.....	760
Clock Input Slope.....	760
Trigger Input Slope.....	760

### Connector

Displays the name of the global connector.

Remote command:

Via suffix `TM<ch>`



### Show Connector

Accesses a dialog that displays the physical location of the selected connector on the front/rear panel of the instrument.

A blinking LED on the front/rear panel indicates the selected connector, too (see [Section 12.2.2.4, "Status indicators"](#), on page 746).

### Direction

Determines whether the connector is used as an input or an output.

Remote command:

`[ :SOURce<hw> ] :INPut:TM<ch>:DIRection` on page 1008

`:OUTPut<hw>:TM<ch>:DIRection` on page 1008

### Signal

Determines the control signal that is input or output at the selected connector. Whether the connector is used as an input or an output is selected by the parameter [Direction](#).

Refer to [Table 12-4](#) for an overview of the available control signals.

The indication <BB> (A/C or B/D; 1/3 or 2/4) in each signal name indicates the baseband that the signal is related to.

**Note:** The T/M/(C) 1/2/3 connectors are shared between the baseband A and C; the T/M/(C) 4/5/6 connectors, between basebands B and D.

"Trigger"	Marks the trigger event caused by the selected trigger signal (internally or externally). To define the trigger, use the respective "Trigger In" tab of the corresponding digital standard.
"Clock"	Input for external clock signal
"Data"	Input for external serial data signal

**"Baseband <BB> Marker 1/2/3"**

A broad selection of suitable marker signals is offered in the "Marker" tab of the corresponding digital standard.

**"Symbol Clock <BB>"**

Output of the internal clock signal used for digital modulations. The signal is generated automatically when the standard is switched on.

**"Lev Att <BB>"**

Output signal that determines whether the signal level is attenuated, if envelope curve control is active.

The internal "Lev Att <BB>" control signal is defined in a control list and activated in the "Baseband > Custom Digital Modulation > Power Ramp Control" dialog.

See also [Section 5.6.3.8, "Control and marker lists editor"](#), on page 284.

**"Burst Gate <BB>"**

Output for control signal for envelope curve control.

This control signal is defined in a control list and activated in the "Baseband > Custom Digital Modulation > Power Ramp Control" dialog. See also [Section 5.6.3.8, "Control and marker lists editor"](#), on page 284.

**"HOP <BB>"**

Marks the hop trigger for frequency hopping in the List mode for "Custom Digital Modulation". The hop signal is defined in a control list and activated by loading the control list, see [Section 5.6.3.8, "Control and marker lists editor"](#), on page 284.

**"CW/Mod <BB>"**

Output signal to indicate the output of RF signal in unmodulated form (digital modulation is deactivated).

This control signal is defined in a control list, see [Section 5.6.3.8, "Control and marker lists editor"](#), on page 284.

**"Triggered <BB>"**

A pulse like marker signal, generated on received internal or external trigger signal in the corresponding Baseband.

**"Feedback"**

Input for local feedback signal, required for 3GPP HSUPA HARQ Feedback, 3GPP Dynamic Power Control or EUTRA/LTE Closed Loop BS tests.

Remote command:

[\[:SOURce<hw>\]:INPut:TM<ch>:SIGNal](#) on page 1009

[:OUTPut<hw>:TM<ch>:SIGNal](#) on page 1010

**Threshold Clock/Trigger Input**

Sets the high/low threshold in volts for the trigger and clock signal inputs of the baseband section.

Remote command:

[\[:SOURce<hw>\]:INPut:TM:CLOCK:LEVel](#) on page 1015

[\[:SOURce<hw>\]:INPut:TM:TRIGger:LEVel](#) on page 1015

**Impedance Clock/Trigger Input**

Selects the input impedance for the external trigger/clock inputs.

Remote command:

`[ :SOURce<hw> ] :INPut:TM:CLOCK:IMPedance` on page 1015

`[ :SOURce<hw> ] :INPut:TM:TRIGger:IMPedance` on page 1015

**Clock Input Slope**

Sets the polarity of the active slope of an externally applied clock signal.

When using custom digital modulation with external serial data, a higher bit modulation requires a reference symbol clock signal. You need this reference signal to generate a bit clock out of it.

- This parameter sets the active edge of the symbol clock.
- To set the active edge of the bit clock, use the parameter "Bit Clock Slope".
- Observe the impact of this parameter on the preview graphic in the "Data Source" tab: "Baseband" > "Custom Digital Mod" > "Data Source".  
See also "[External modulation data](#)" on page 226.

Remote command:

`[ :SOURce<hw> ] :INPut:TM:CLOCK:SLOPe` on page 1015

**Trigger Input Slope**

Sets the polarity of the active slope of an externally applied trigger signal.

Remote command:

`[ :SOURce<hw> ] :INPut:TM:TRIGger:SLOPe` on page 1016

## 12.2.7 Routing signals to the connectors

This chapter provides step-by-step instructions to route control signals from input connectors or to output connectors of these signals. It covers the following topics:

- "[General workflow](#)" on page 760
- "[To map the signal to a connector](#)" on page 761
- "[To find out the input connector location](#)" on page 761

**General workflow**

The table [Table 12-6](#) shows the main configuration steps and related settings.

**Table 12-6: Mapping signal to connector workflow**

Workflow task	Related settings
Checking the signal to connector mapping	"Trigger Marker Clock" "Global Connectors" > "Routing" "Local Connectors" > "Routing"
Configuring and enabling the control signal	"Trigger In", "Marker" or "Clock" tabs of the base-band signal dialog
Cabling the connector and the source or sink of the control signal	-



**To map the signal to a connector**

To map the signal to the connector, proceed as follows:

1. Check the current connector configuration.
2. If necessary, change the signal direction and the signal type.
3. Configure the control signal, for example a trigger signal or a marker signal.
4. Enable the control signal.
5. Connect a suitable external instrument or device to the connector of the control signal.

See also [Section 3.3.4, "Working with marker signals"](#), on page 62.

**To find out the input connector location**

Proceed as follows:

1. In the block diagram, select the "TMC" block to open the "Trigger / Marker / Clock" dialog.
2. In the block diagram, select the "TELPV" block to open the "RF Connectors" dialog.
3. For the corresponding connector, select the "Show Connector" icon.

The "Show Connectors" dialog opens and displays the location of the selected connector on the front panel or rear panel of the instrument.

If enabled, the LED next to the connector is green or yellow, see [Section 12.2.2.4, "Status indicators"](#), on page 746.

## 12.3 Checking parameters and dependencies

You can check settings on a parameter-level for incoming dependencies. These dependencies include R&S SMW200A configurations that affect properties of the parameter. Properties are, for example, selectable values, ranges, minimum or maximum value depending on the parameter type. After the dependency check, a dialog displays R&S SMW200A configurations that include a list of dependent parameters or dependent settings that affect the parameter.

1. Select the parameter that you want to check.
2. Right-click the parameter, to open the context menu.
3. Select "Show Incoming Dependencies".

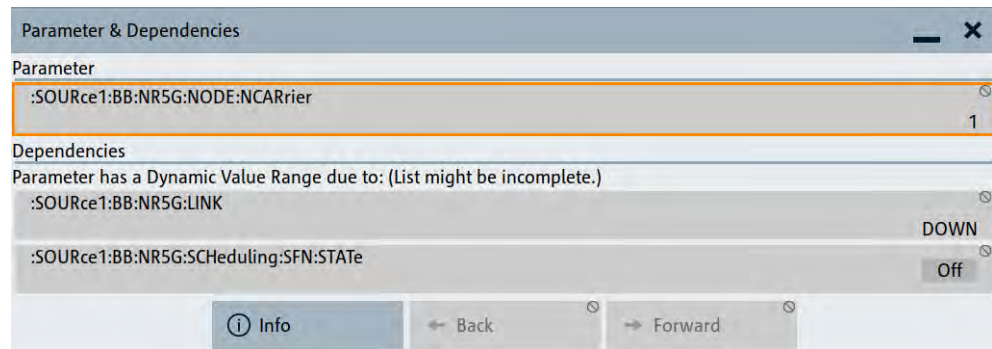

The "Parameter & Dependencies" dialog opens. The "Parameter" panel of this dialog displays the SCPI command including its setting or query parameters. The "Dependencies" panel displays dependent parameters and their settings that affect the setting of the parameter, that you want to check initially (2).

4. In the "Dependencies" panel, you can further check for dependencies within the dependent parameters.
  - a) Select the parameter that you want to check from the list in the "Dependencies" panel, e.g.:  
 :SOURce1:BB:NR5G:LINK DOWN for the "Link Direction" > "Downlink".

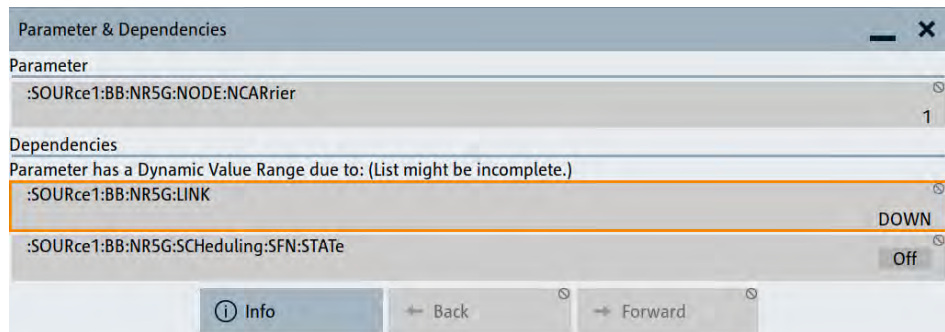

- b) Select "Show Incoming Dependencies".

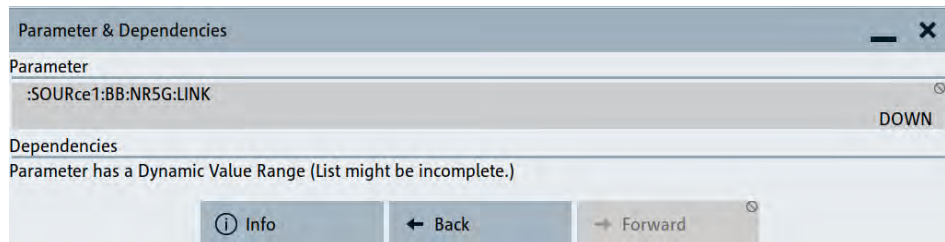

The list in the "Dependencies" panel is empty. I.e., the "Link Direction" setting does not depend on any further parameters or settings.

5. Optionally, navigate via "Back" and "Forward" to move up or down the dependency tree for parameters with dynamic value range.

**Settings:****Info**

Accesses the help of the selected parameter, see [Section 12.3, "Checking parameters and dependencies"](#), on page 761.

**Back/Foward**

Toggles between parameter dependencies for dependent parameters.

If you select "Show Incoming Dependencies" for parameters or settings from the "Dependencies" panel, you can move back or move forward through the dependency tree-like structure.

## 12.4 Organizing frequently used settings as favorites

The R&S SMW200A provides two possibilities to define frequently used settings and procedures for later retrieval individually.

**User menu and [USER] key**

These two functions work similar to the favorites function of a browser or other programs. They allow you to create a list of frequently used actions or to group frequently used settings in one dialog.

You can collect the parameters of your configuration in a favorites list, i.e. in the "User Menu", or define settings and actions with the [USER] key:

- "User Menu" to group settings of specific tasks.  
Similar to a favorites function, you can use this menu for:
  - Grouping the settings required for a task in one dialog.
  - Saving and recalling the settings of a task.
  - Transferring the settings for use on multiple instruments.
- [USER] key, with customizable function.  
You can perform the following steps using this key:
  - Open the "User Menu" (default functionality).
  - Add or remove settings and functions.
  - Execute actions and access functions.

**Possible applications**

The USER key and the "User Menu" are useful for the following situations:

- There are functions or tasks you have to perform in a defined order but the setting parameters are distributed across several dialogs.
- There are functions or tasks you have to perform frequently but they are not accessible via the front panel keys.
- The required functions are grouped in a dialog that is not directly accessible from the block diagram.

- Your task involves loading and executing of SCPI scripts.  
See [Section 13.9, "Using remote command scripts"](#), on page 874.
- A quick access to saved setups is required.
- There are functions and tasks you have to perform on several instruments.

### Dialog identification

To identify each dialog, the instrument uses a dedicated dialog ID. The dialog ID contains the dialog position on the display and the current active tab. The action that triggers the instrument to open a dialog uses this identification.

### Save/Recall vs. recall setup

If you need to restore a specific signal generation setup and perform further configurations based on this particular instrument state, the R&S SMW200A provides two options:

- "Save/Recall" function  
For a detailed description, refer to [Section 11.4, "Saving and recalling settings"](#), on page 708.
- "Recall Setup" function  
If the "Recall Setup" is the only user action assigned to the [USER] key, pressing this key triggers the R&S SMW200A to load the user-defined preset file immediately.



Recalling a user-defined preset file using the [USER] key is even faster than the immediate recall function provided by the [SAVE/RCL] key.

### 12.4.1 Configuring settings quickly with the user menu

Access:



1. Press the [USER] key.  
The "User Menu" dialog opens.



If you execute this action for the first time, the dialog displays instructions on how to use the "User Menu".

2. If you already have a saved user menu file on the instrument, you can load with "Recall User Menu".

#### Creating a user menu

To create your own user dialog with settings:

1. Open a dialog with settings you frequently use.
2. Select a parameter.
3. Open the context menu and select "Add to User Menu".

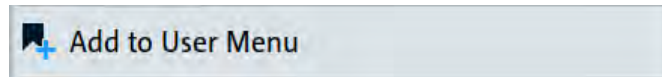

A favorites icon ★ indicates that the parameter is used in the "User Menu".

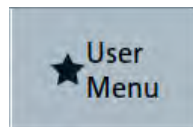

The "User Menu" button in the taskbar confirms that you have created a "User Menu" with at least one entry.

4. Press the [USER] key.

The "User Menu" dialog shows all parameters that you have added to the list.

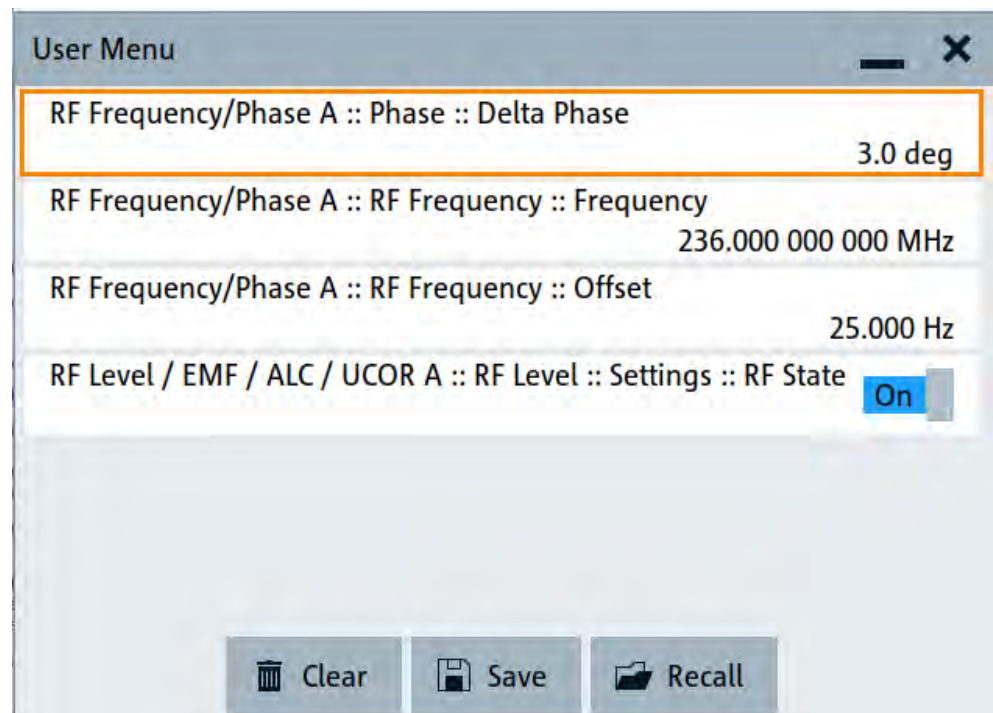

You can modify the parameter settings directly in this dialog, e.g. change a state or set values, as you do in the particular dialog the parameter originally belongs to.

5. To remove an entry, select the parameter either in the "User Menu" or in the dialog where it originally belongs to.
  - a) Open the context menu and select "Remove from User Menu".

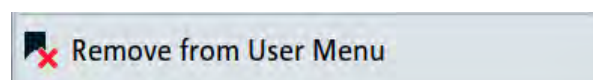

6. To remove all entries at once, select "Clear User Menu".

7. To save your individual favorites list, select "Save User Menu", and follow the file managing instructions.  
The file system automatically assigns the file extension \*.user\_menu.
8. To recall a previously saved user menu, select "Recall User Menu" and proceed accordingly.

#### Providing a user menu favorites list for several instruments

To transfer files from or to an instrument:

1. Create the favorites list, as described in ["Creating a user menu"](#) on page 765.
2. Save the favorites list.
3. To transfer a file from or to an instrument, the R&S SMW200A provides several options, see ["File handling"](#) on page 701.

### 12.4.2 How to assign actions to the [USER] key

The customizable [USER] key has no predefined function assigned. You can individually define actions to be executed or functions to be accessed when pressing this key.

To assign a frequently used dialog to the [USER] key:

1. Open the dialog you want to quickly access.  
For example, select "Baseband" > "EUTRA/LTE" > "DL Frame Configuration" > "Time Plan" > "Detach Time Plan".
2. Select "System Configuration" > "Setup" > "User Interface" > "Define User Key".
3. To create an action:
  - a) Specify the "Name".  
E.g. *LTE\_ShowTimePlanDL*.
  - b) Select "Wizard" > "Open Dialog"
  - c) Select "Select Dialog" and select a settings dialog from the list

The corresponding SCPI command is automatically displayed and can be modified.

4. Select "Add" to save the new action in the list of user key actions.

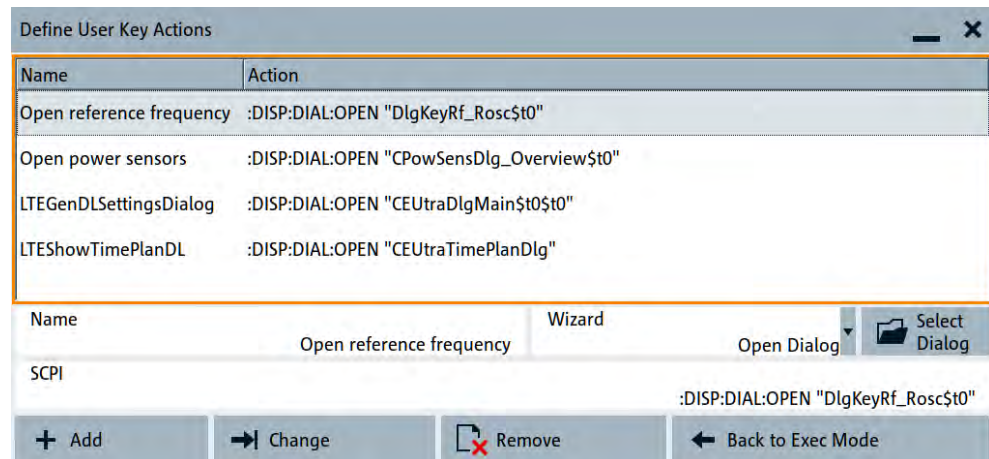

5. To execute the created action, press USER.  
 In the list of actions ("Define User Key Actions" dialog), navigate to the required action.  
 In this example, this is "LTEShowTimePlanDL".

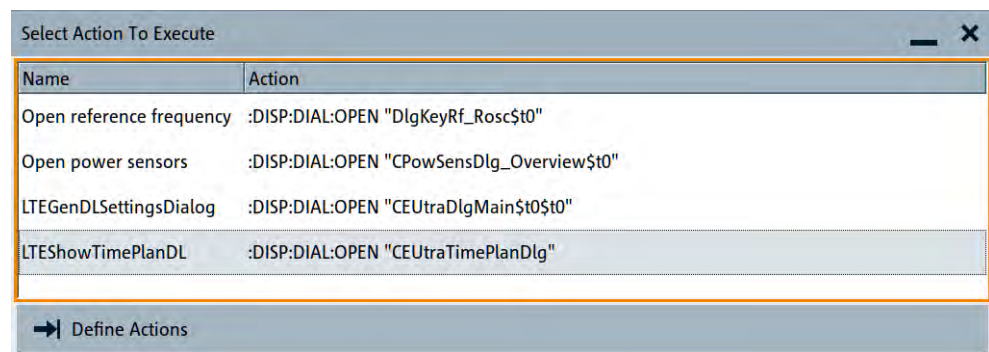

The R&S SMW200A opens the dialog.

**Tip:** If you have assigned only one action to the user key, the R&S SMW200A performs the action immediately.

### 12.4.3 User menu settings

The "User Menu" dialog contains function keys to organize, save and load a favorites list. You can also modify, add or delete list entries directly in the dialog.

#### Clear User Menu

Removes all entries from the "User Menu" at once.

#### Save User Menu

Saves the current "User Menu" under the defined filename.

#### Recall User Menu

Loads the selected "User Menu" file.



This function enables you to use the user specific favorites file on another instrument. However, if functions or parameters are not provided due to varying configuration of the instrument, the settings of these particular parameters take no effect.

#### 12.4.4 Define user key actions settings

Access:

- ▶ Select "System Config" > "Setup" > "User Interface" > "Define User Key".

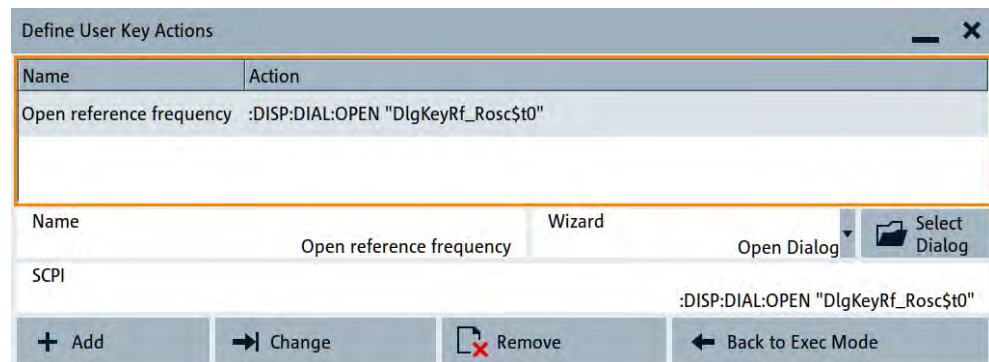

The dialog displays a list of the currently enabled actions and provides functions to define new, edit or remove existing actions. If no actions have been defined, the list is empty.

See [Section 12.4.2, "How to assign actions to the \[USER\] key"](#), on page 767.

See also the application sheet RS\_SMW\_FastDataAlignment\_AppSheet, available for download at [www.rohde-schwarz.com/manual/smw200a](http://www.rohde-schwarz.com/manual/smw200a).

The remote commands required to define these settings are described in [Section 14.12, "DISPlay subsystem"](#), on page 933.

##### Name

Enters a user-defined name for the action.

##### Wizard

Defines the action to be executed.

"Load SCPI Script"

Selects and executes the SCPI script.

"Recall Setup"

Opens the file dialog for selecting a saved setup with user-defined settings.

"Open Dialog"

Selects an open settings dialog or menu.

"Open Dialog, with Position and Size/append to SCPI"

Selects an open settings dialog or menu.

Use the "Open Dialog, append to SCPI" function to define a sequence of several dialogs to be opened simultaneously or one after the other.

**Tip:** Use the command `:SYSTem:WAIT` to add a delay between the subsequent commands.

### Select

Depending on the selected "Wizard", provides access to:

- the standard "File Select" function for loading an SCPI script or setup file
- a list of all currently opened dialogs.  
See [SCPI](#).

### SCPI

For the currently selected action, displays the corresponding SCPI command with the associated parameter for dialog identification (dialog ID). The automatically displayed SCPIs are enabled for subsequent modification.

Remote command:

`:DISP:play:DIAL:OPEN` on page 937

See also `:DISP:play:DIAL:ID?` on page 936

### Add, Change, Remove

Standard functions for managing of the actions.

### Back to Execute Mode

Opens the "Select Action to Execute" dialog. Select an Action form the list to execute it.

To return to the "Define User Key Actions" dialogs, select [Select Action to Execute > Define Actions](#).

### Select Action to Execute > Define Actions

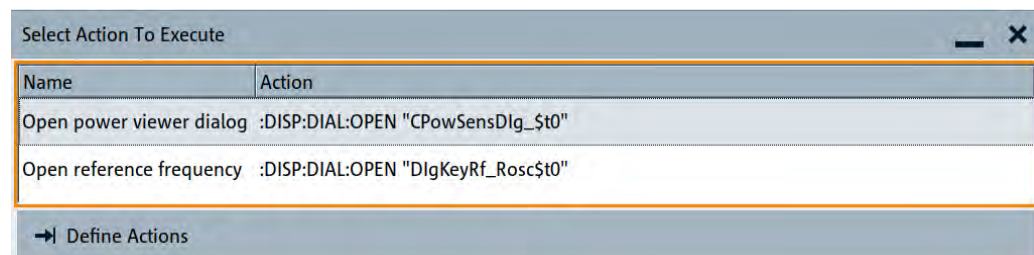

Opens the "Define User Key Actions" settings dialog.

## 12.5 Managing licenses and license keys

The R&S SMW200A provides options for all required applications, as, e.g., for digital standards, you can purchase and activate.

Various license types enable you to manage licenses for options as follows:

- Activate an option locally on an instrument.
- Share an option with other instruments.
- Activate an option for a certain period of time as needed.

An option is ready to operate after it is enabled with a license keycode supplied with the option. The license key is delivered as a file or on paper. Unregistered licenses must be registered for a particular instrument before the corresponding option can be enabled for operation.



For reliable operation, a software option usually requires the latest firmware version. The required version is specified in the delivery. If your instrument works with a former firmware version, update the firmware before enabling the software option.

The firmware update is described in the release notes provided on the product page of the R&S SMW200A.

### Trial license

The trial license (option R&S SMW-T0) allows you to use additional applications that normally require a separate license for each. The option is pre-installed at the factory on request. If enabled, you can use the included applications for a limited period of time (90 days from factory installation).

A special tag indicates applications that are enabled as trial license, e.g.:

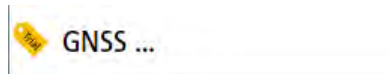

Currently, the R&S SMW-T0 trial license includes the options:

- R&S SMW-K17, Wideband differential analog I/Q outputs, see [Section 4.8, "I/Q analog output settings"](#), on page 176.
- R&S SMW-K22, Pulse modulator, R&S SMW-K23, High performance pulse generator, R&S SMW-K24, Multifunction generator and R&S SMW-K720, AM/FM/PhiM, see [Section 8.11, "Analog modulations"](#), on page 546.
- R&S SMW-K44/-K66/-K94/-K107, GNSS, Galileo, Glonass, BeiDou, see the user manual "R&S SMW Satellite Navigation", provided on the R&S SMW200A product page.
- R&S SMW-K61, Multi carrier CW signal generation, see [Section 5.11, "Generating multicarrier waveform signals"](#), on page 391.
- R&S SMW-K62, Additive white gaussian noise (AWGN), see [Section 6.2, "Adding noise to the signal"](#), on page 424.
- R&S SMW-K540/-K541, Envelope tracking, AM/AM, AM/PM digital predistortion, see the user manual "R&S SMW200A Envelope Tracking" on the R&S SMW200A product page.
- R&S SMW-K542, Baseband power sweep, see the user manual "R&S SMW200A Baseband Power Sweep" on the R&S SMW200A product page.

- R&S SMW-K544, User-defined frequency response correction, see the user manual "R&S SMW200A Frequency Response Correction" on the R&S SMW200A product page.
- R&S SMW-K548, Crest factor reduction, see the user manual "R&S SMW200A Crest Factor Reduction" on the R&S SMW200A product page.
- R&S SMW-K703, 100 MHz, 1 GHz ultra low noise reference input/output, and R&S SMW-K704, Flexible reference input (1 MHz to 100 MHz), see [Section 8.8, "Reference oscillator"](#), on page 491.
- R&S SMW-K739, Differential analog I/Q inputs for RF path A, see [Section 7, "Applying I/Q vector modulation"](#), on page 458.
- R&S SMW-K810, Enhanced noise generation, see [Section 6.3, "Generating impulsive and phase noise"](#), on page 442.
- R&S SMW-K811, Notched signals, see [Section 5.8, "Generating notched signals"](#), on page 353.

If the trial option has expired, the R&S SMW200A displays a message box and blocks further use of the options.

To continue using the optional applications, you must acquire a permanent license and enable it as described in [Section 12.5.1, "Manage license keys settings"](#), on page 773.



### Occupied Licenses

A license server allows you to use one or more options with floating license for a specified period of time.

Provided the R&S SMW200A is connected one or more license servers, it shows the currently unoccupied, i.e. available options. You can borrow the license for one or more options and specify the required time period.

The maximum number of options you can occupy is determined by the minimum number of available options on the server, and the maximum number of options you can install on the instrument, including the permanently installed options.

Once you have occupied an option, the instrument saves the license locally, and blocks it for other instruments. During the occupied period, you do not necessarily need permanent access to the license server. If you need the option for a longer time than you have occupied, you can extend the requested occupation period up to 7 days.

When the occupation period elapses, the license expires automatically. After 1 hour follow up time, the option is available again on the license server.



You cannot return or disable the license of an option manually before the occupation period has elapsed.

If the R&S SMW200A has no connection to the license server, it displays a warning message.

### 12.5.1 Manage license keys settings

The "Manage License Keys" dialog provides all information on the available licenses. Instrument-related steps guide you through the process of registering or deactivating licenses.

Access:

1. Select "System Config" > "Setup" > "Instrument Assembly" > "Manage License Keys" > "New License".

Manage License Keys

New License | Installed License Keys | Trial License On | Occupy Licenses

Device ID: 1412.0000K02-000000-eR

Enter License Key

Enter License Key: \*\*\*\*\*

Import License Key From File |  Export Deactivation Response To File

License Installation Info

In this tab, you can activate licenses for newly purchased or newly registered options.

2. Select "Installed License Keys".

Manage License Keys

New License | Installed License Keys | Trial License On | Occupy Licenses

Show Inactive  | Show Deactivated  | Open License Server

Export License Key To File	Option	License Count	License Type	Registrations
1 ...	SMW-B13XT	1	Permanent	
2 ...	SMW-B9	2	Permanent	
3 ...	SMW-B15	4	Permanent	
4 ...	SMW-B90	1	Permanent	
5 ...	SMW-B711	1	Permanent	

This tab lists all active options, with information on the available number of an option, the license type and registration. You can query inactive or disabled options also.

3. Select "Open License Server".
4. Select "Manage Waveform Packages".

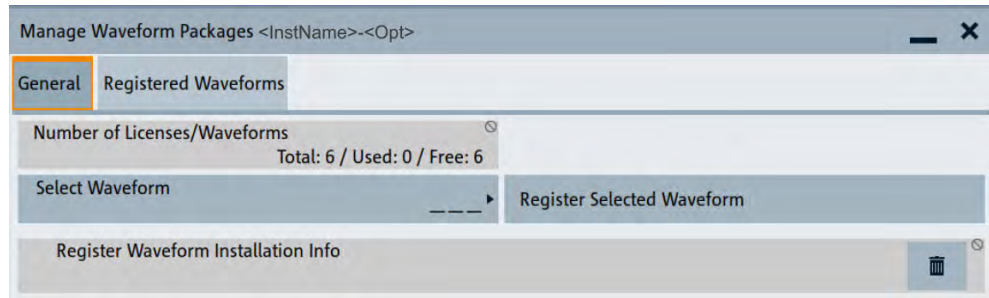

This tab enables you to select and register purchased waveform packages.

5. Select "System Config > Setup > Instrument Assembly > Manage License Keys > Trial License".

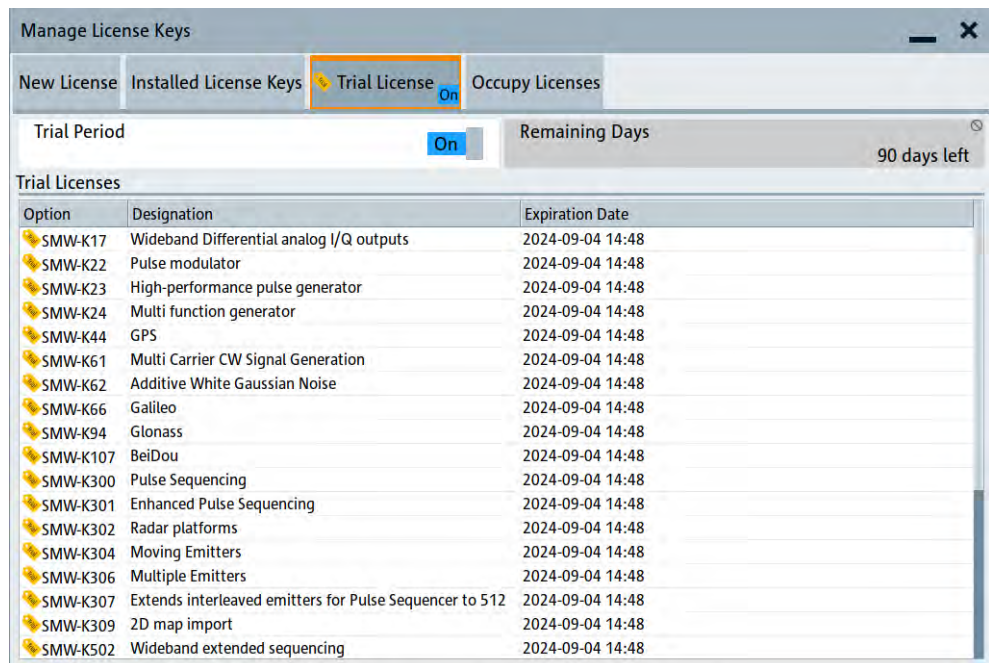

This tab lists all installed and activated time-limited licenses with information on the expiration date.

6. Select "System Config > Setup > Instrument Assembly > Manage License Keys > Occupy Licenses".

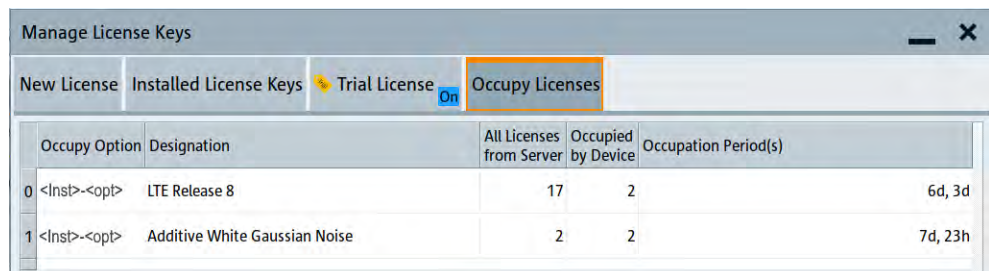

The tab lists all options available on the license server, the number of options already occupied by the R&S SMW200A and the state of their occupation period. The occupation period indicates the remaining time you can use the option. How to occupy a license or to extend the occupation period, see [Section 12.5.3, "How to occupy or extend a license"](#), on page 789.

The "Manage License Keys" dialog covers all required parameters for activating or deactivating newly purchased or newly registered options, and provides access to the onboard license server, see [Section 12.5.2, "Using the license server"](#), on page 780.

### Settings:

Device ID.....	775
Enter License Key.....	775
Import License Key from File.....	776
Export Deactivation Response to File.....	776
License Installation Info.....	776
Installed License Keys.....	776
L Show Inactive.....	776
L Show Deactivated.....	776
L Installed License Keys Table.....	776
Open License Server.....	777
Manage Waveform Packages.....	777
L Number of Licenses/Waveforms.....	777
L Select Waveform.....	777
L Register Selected Waveform.....	777
L License Table.....	777
Trial License.....	778
L Trial Period.....	778
L Remaining Days.....	778
L Trial License Table.....	778
Occupy Licenses.....	778
L License Info.....	779
L Select Free Licenses.....	779
L Occupation Period.....	779
L Occupy.....	779
L License <no>: Extend Occupation Period to.....	779
L Renew.....	779

### Device ID

Displays the instrument-specific identification number. The device ID is a unique string with the following structure:

```
<stock number>-<serial number>-<checksum>
```

### Enter License Key

Type here the license key provided with the option.

For license keys delivered as a file, use [Import License Key from File...](#)

**Import License Key from File...**

Opens a dialog for selecting the file with the license key.

Use this function also to import the deactivation key file generated by the R&S License Manager online tool (see [How to move a portable license](#)).

**Export Deactivation Response to File...**

Exports the generated deactivation response key to a file and opens a file management dialog to save the file.

This key is required during the unregistration process, e.g. when you want to deinstall an option or have a portable option, which you want to register later on another instrument (see [How to move a portable license](#)).

**License Installation Info**

Indicates status information on the performed actions.

**Installed License Keys**

Access: select "System Config > Setup > Instrument Assembly > Manage License Keys > Installed License Keys".

Comprises information on the installed options.

**Show Inactive ← Installed License Keys**

Enables the display of the inactive (expired) licenses in the [Installed License Keys Table](#).

**Show Deactivated ← Installed License Keys**

Enables the display of the deactivated licenses in the [Installed License Keys Table](#).

See [How to move a portable license](#) for information on how to activate deactivated licenses.

**Installed License Keys Table ← Installed License Keys**

Shows information on the currently installed options.

**"Export License Key to File"**

Opens a dialog to save the generated license key file. This file is required during the unregistration process.

If you have a portable unregistered option, you can register it later on another instrument (see [How to move a portable license](#)).

**"Option"**

Displays the short designation of the option.

**Note:** Open the [Hardware Options/Software Options](#) dialog to retrieve more information about the installed options.

**"License Count"**

Displays the number of the licenses for the selected option key.



- "License Type" Displays the type of license.  
A license type determines the common qualification application duration and the portability of a license. The following license types are provided: evaluation, permanent, portable, quantified, time-controlled with a duration of 1, 3, 6 or 12 months. A license can also be deactivated or expired.  
For time limited licenses, the left time of applicability is displayed too.
- "Registrations" (reserved for future use)

**Open License Server**

Opens the R&S License Server of the R&S SMW200A, see [Section 12.5.2, "Using the license server"](#), on page 780.

**Manage Waveform Packages**

Access: select "System Config > Setup > Instrument Assembly > Manage License Keys > Installed License Keys > Manage Waveform Packages".

Opens the "Manages Waveform Packages" dialog that enables you to register waveform files.

With a waveform packages license, the R&S SMW200A can play a waveform file generated with the R&S WinIQSIM2 software, even if it is not equipped with the corresponding digital standard option for using R&S WinIQSIM2 (R&S SMW-K2xy/K4xy).

**Note:** One waveform packages license per waveform is required, and for multisegment waveforms, you need a license per segment.

Once registered license cannot be moved to another instrument.

A waveform packages license does not allow R&S SMW200A to play waveforms of options R&S SMW-K256/-K352/-K353/-K354.

**Number of Licenses/Waveforms ← Manage Waveform Packages**

Displays the number of the available and used R&S SMW-K200 licenses.

**Select Waveform ← Manage Waveform Packages**

Opens a standard dialog to select the waveform to be registered.

**Register Selected Waveform ← Manage Waveform Packages**

Executes the registration.

**License Table ← Manage Waveform Packages**

Gives an overview of the registered waveforms, the registration date and the number of used licenses.

"Waveform" Displays the directory, path and file name of the waveform file.

"Registration Date"  
Displays date and time of registration.

"Used License(s)"  
Shows the number of licenses the waveform file requires.

**Trial License**

Access: select "System Config > Setup > Instrument Assembly > Manage License Keys > Trial License".

Option: R&S SMW-T0

A trial license determines a series of applications you can include and enable for a limited period of 90 days. Within this period, you can deactivate and activate the license as often as needed using the [Trial Period](#) function.

**Trial Period ← Trial License**

Activates the options specified in the trial license.

See [Trial License Table](#) for the included options.

Remote command:

`:SYSTEM:OPTion:TRIAL[:STATE]` on page 1321

**Remaining Days ← Trial License**

Displays the remaining validity period of the time limited trial license.

Remote command:

n.a.

**Trial License Table ← Trial License**

Shows information on the options included in the trial license.

"Option"	Displays the short designation of an option. <b>Tip:</b> Open the <a href="#">Hardware Options/Software Options</a> dialog to retrieve more information about the installed options.
"Designation"	Displays the option name.
"Expiration Date"	Displays the end date of the time limited trial license.

Remote command:

`:SYSTEM:OPTion:TRIAL:LIST?` on page 1321

**Occupy Licenses**

The license server allows you to borrow one or more options with floating licenses for a specified time. You can retrieve a non-occupied license and save it locally for up to 7 days.

Access:

Select "System Config" > "Setup" > "Instrument Assembly" > "Manage License Keys" > "Occupy Licenses".

The table lists all options that are available on the license server. It covers the short and long name, the number of available options on the server, the number of already occupied options and the remaining time periods for their use.

To occupy or renew a license, select "Occupy Option".

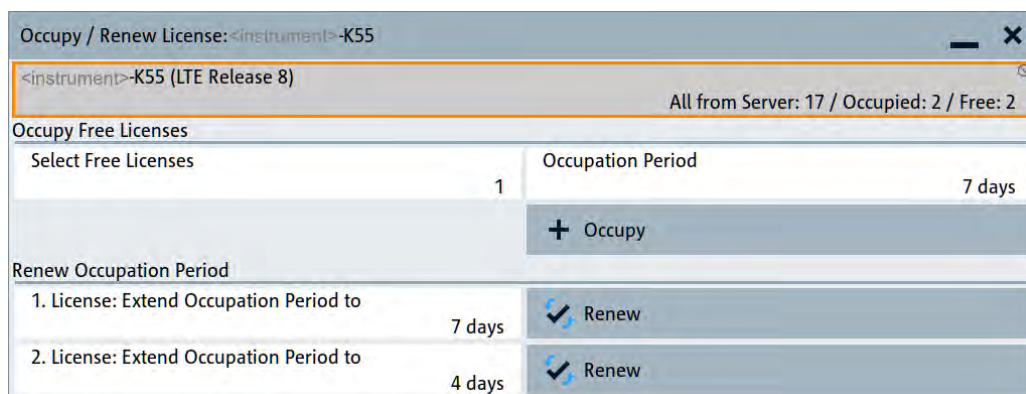

Remote command:

[\[:SOURCE\]:OCCupy:OPTion:CATalog?](#) on page 1261

### License Info ← Occupy Licenses

Displays the current occupancy state of the selected option.

"<instrument>-<option>"

Short name of the option.

"(<designation>)"

Long name of the option.

"All from Server: <no>"

Number of options available on all connected license servers.

"Occupied: <no>"

Number of options occupied by the instrument.

"Free: <no>"

Remaining number of options that can be occupied on the instrument.

### Select Free Licenses ← Occupy Licenses

Sets the number of licenses to occupy.

### Occupation Period ← Occupy Licenses

Sets the occupation period for the selected option in days.

### Occupy ← Occupy Licenses

Executes the occupation process.

The R&S SMW200A saves the selected options locally and removes the licenses from the list of available options on the license servers.

Remote command:

[\[:SOURCE\]:OCCupy:OPTion](#) on page 1261

### License <no>: Extend Occupation Period to ← Occupy Licenses

Extends the occupancy duration set before to the required length.

**Note:** You can only extend an already set occupation period.

Reset or return an occupied period before the time has elapsed is not possible.

### Renew ← Occupy Licenses

Executes the extension of the occupation period.

The R&S SMW200A saves the selected options locally and removes the licenses from the list of available options on the license servers.

Remote command:

[ :SOURce ] :OCCupy:OPTion:RENew<ch> on page 1261

## 12.5.2 Using the license server

The R&S SMW200A now supports handling of software licenses using the license server from Rohde & Schwarz.

As a browser application you can access the R&S License Server either in a browser and also directly in the R&S SMW200A. The onboard license server integrated in the instrument firmware has connection to a *local smartcard* memory. The local smartcard holds local licenses, i.e. licenses that are intended for use on this specific instrument.

As opposed to local licenses, the application also manages licenses referred to as *floating licenses*.

For managing floating licenses, the same license server application runs on a PC at customer's site. In this context referred to as *remote license server*, with connection to the customer's memory, the *remote smart card*. The remote smartcard holds floating licenses, i.e. licenses you can use on instruments everywhere without restrictions on the location.

When you need a specific application, you can obtain a license from the server. When you no longer need the license, return it to the server.



The license server releases a returned floating license for use in another instrument only after a follow-up time of 10 minutes.

At startup, the license server checks the available floating licenses. During this check, it returns the licenses immediately.



The floating license server application is part of the configuration at purchase. Included in delivery, you get an installation package that consists of a smart card dongle with the software and the corresponding user documentation.

### To open the license server

Access:

1. Select "System Config > Setup > Instrument Assembly > Manage License Keys > Installed License Keys".

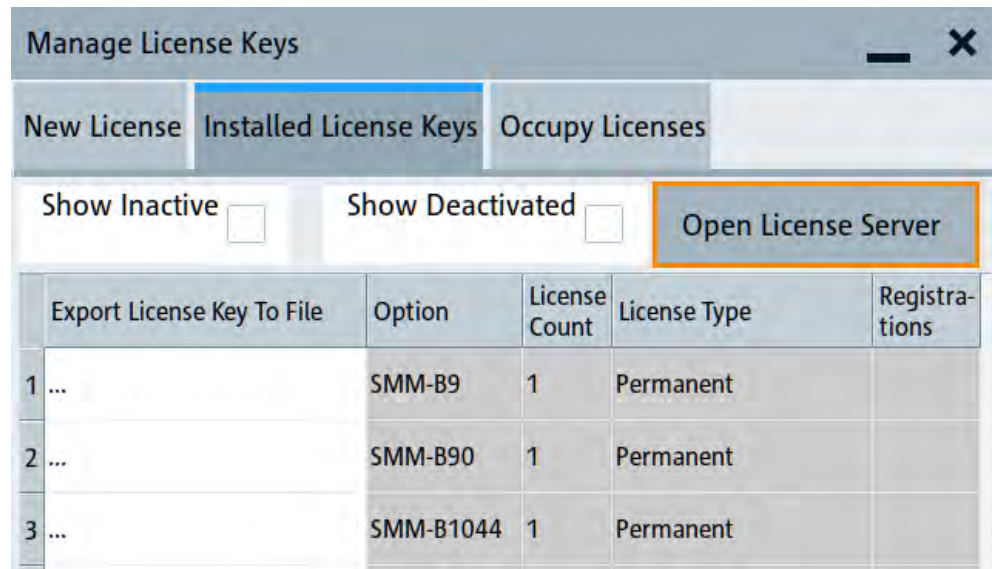

2. Select "Open License Server".

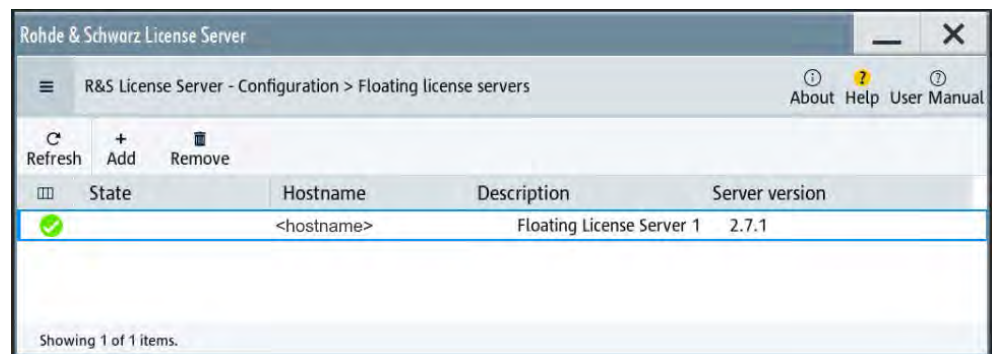

**Figure 12-2: R&S license server dialog**

The license server opens in a browser window and starts initially in the "Configuration" view for configuring floating license servers. It lists already configured floating license servers, with information on the host address, designation and state. You can add or remove a floating license server configuration and customize the information to be displayed. The control elements in the upper area enable you to access the "Analytics" or "Licenses" views.

The icons in the status bar on the right lead you to information on the license server:

- "About": shows the software version.
- "User Manual": opens the embedded license server user manual.
- "Help": provides the functional description on a specific dialog and its settings.



For security reasons, the license server of the R&S SMW200A enables you to restrict the access to the floating licenses from an external instrument.

For information on how to restrict the access to the connections, see ["To restrict remote connection access"](#) on page 787. To release a restriction, see ["To enable remote connection access"](#) on page 788.

For more information, see the user manual of the license server.

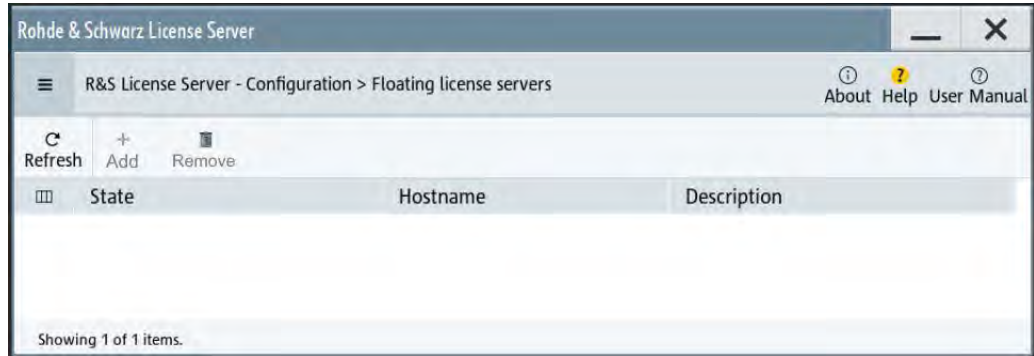

### Short glance at the main views

The section provides a brief insight into the main windows of the license server. For details and handling of the application, refer to the embedded user documentation.



1. To access a view, select the menu button.
2. Select "Configuration".

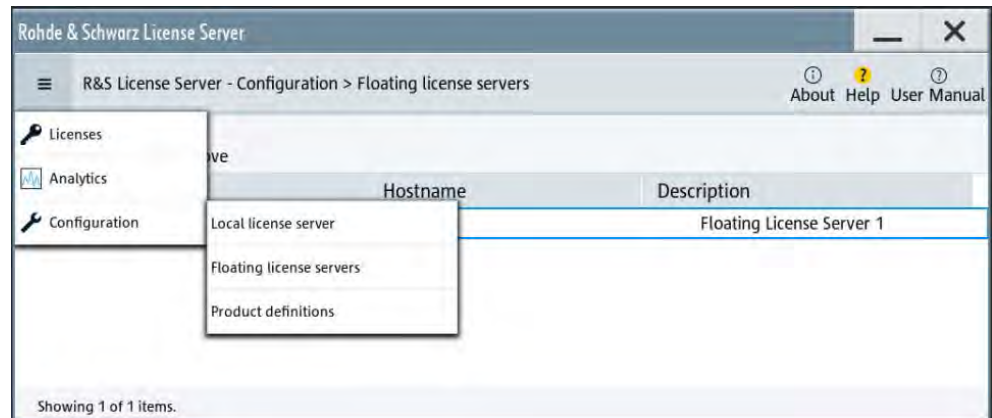

**Figure 12-3: Configuration menu**

Accesses the configured license servers, access lists and installed product definitions.

- a) Select "Local license server".

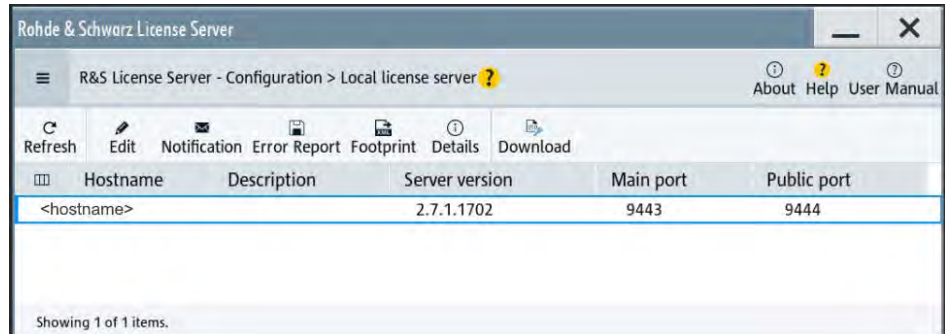

**Figure 12-4: Example of a local license server view**

Shows the onboard license server of the instrument. With the column selection, you can indicate or unhide characteristics of the available server. The task bar buttons provide access to the corresponding functions and access lists.

- b) Select "Floating license server".

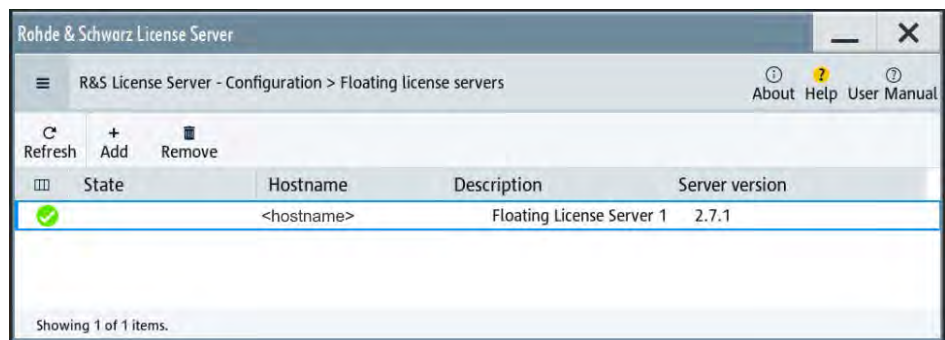

**Figure 12-5: Example of a floating license server view**

To add the connection to a floating license server, see ["To add a remote connection to an external license server"](#) on page 789.

- c) Select "Product definitions".

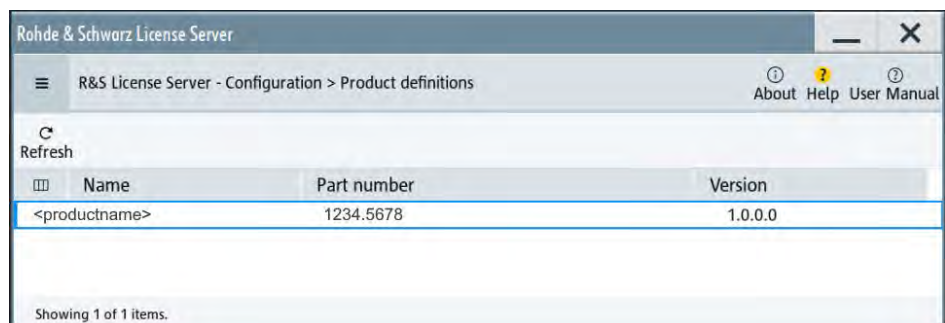

**Figure 12-6: Example of a product definition view**

Shows installed product definitions. To view the available characteristics, use the column selection.

3. Select "Licenses".

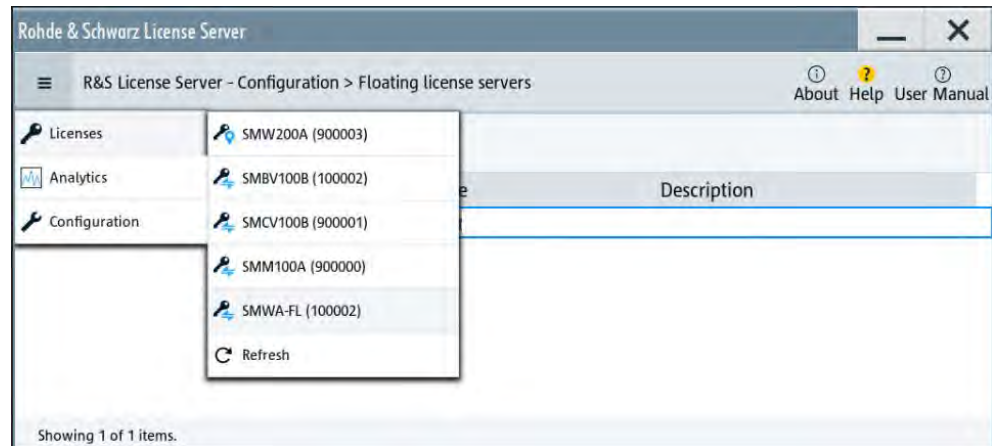

Figure 12-7: Licenses menu

Provides access to the available license servers.

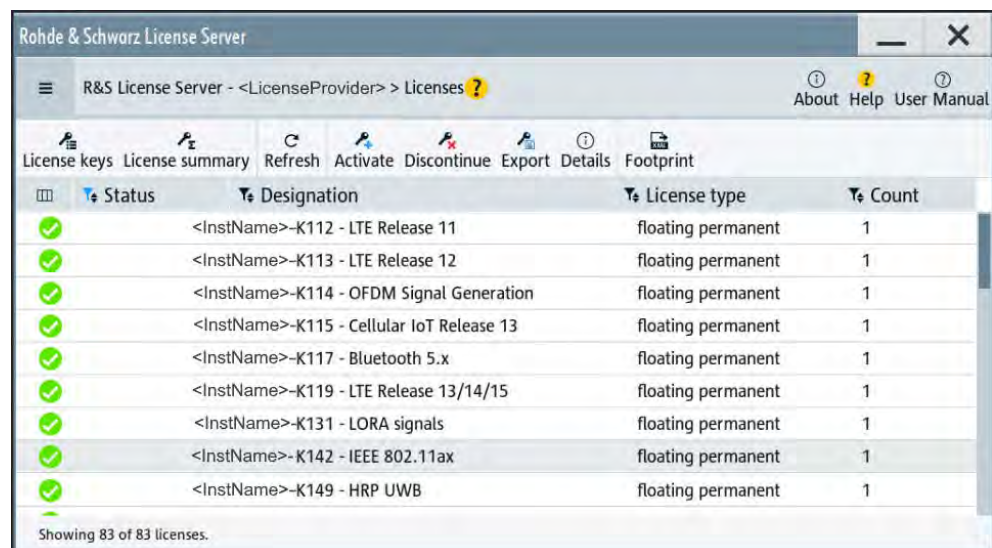
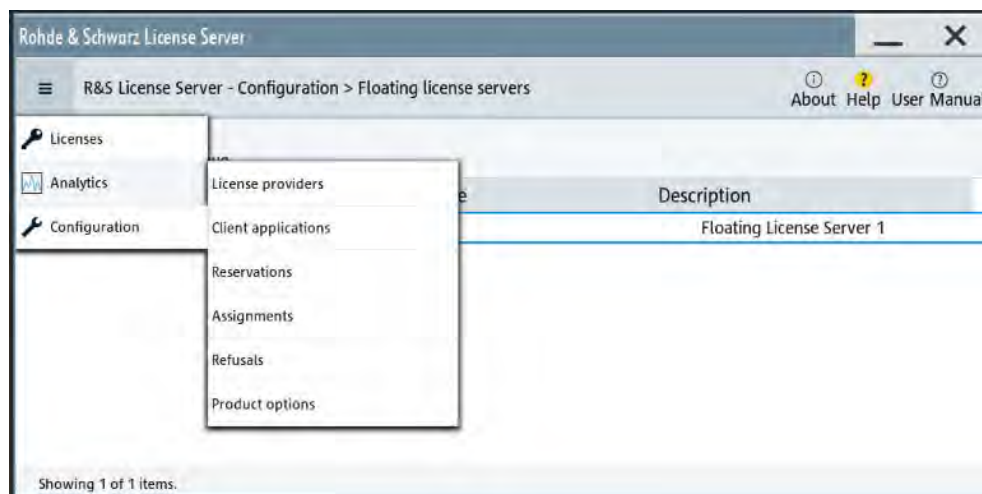

Figure 12-8: Example of a license keys view

The "License keys" view lists the license key options that are available on the selected server. To show additional information, use the column selection. The task bar functions enable you to activate or deactivate a license, to get details on an option and export license keys or information on the selected product.

4. Select "Analytics".





**Figure 12-9: Analytics menu**

Provides access to the license providers, client applications and enables you to export statistics data for evaluation in external applications.

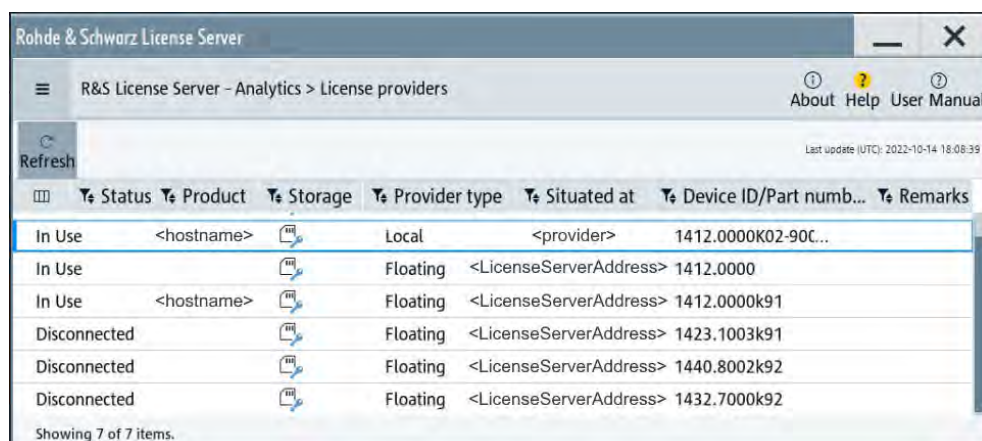

**Figure 12-10: Example of the license providers view**

Shows information on configured client applications, license providers and license types. To show additional information, use the column selection.

### To manage licenses on the R&S SMW200A

To request or return a license, proceed as follows:

1. Access: see ["To open the license server"](#) on page 780.  
The browser application opens.
2. Select "Licenses"
3. Select a license server in the menu list, e.g. "R&S SMW200A".  
The "License keys" view lists the enabled options available on the selected server.
4. Select "Status" > "Select all" to list also options that are currently deactivated.

The "Licenses" view shows all active, inactive and time limited options.

5. To get detailed information on a specific option:
  - a) Select the option in the list.
  - b) In the task bar, select "Details".



Figure 12-11: Example of the license characteristics of an option

6. To enable a discontinued license: , select in the taskbar.

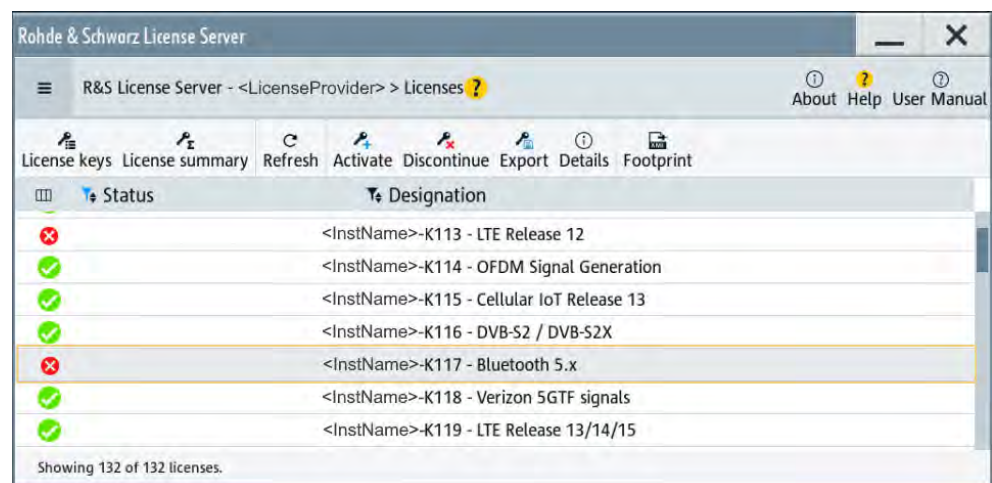

- a) Select the license you want to activate.
  - b) In the task bar, select .
7. To return a license, proceed the same way:
  - a) Select the license.
  - b) Deactivate the license with .
8. Follow the instructions on the screen.

### To restrict remote connection access

If you want to restrict the remote connection to the floating license server of the R&S SMW200A, you can configure specific levels to prevent unauthorized access:

1. Open the license server as described in ["To open the license server"](#) on page 780. The onboard license server browser opens.
2. Select "Configuration" > "Local license server".
3. In the task bar, select "Edit".
4. Select the "Access options" tab.
5. Under "Remote Connection Restriction" restrict the access according to your requirements.

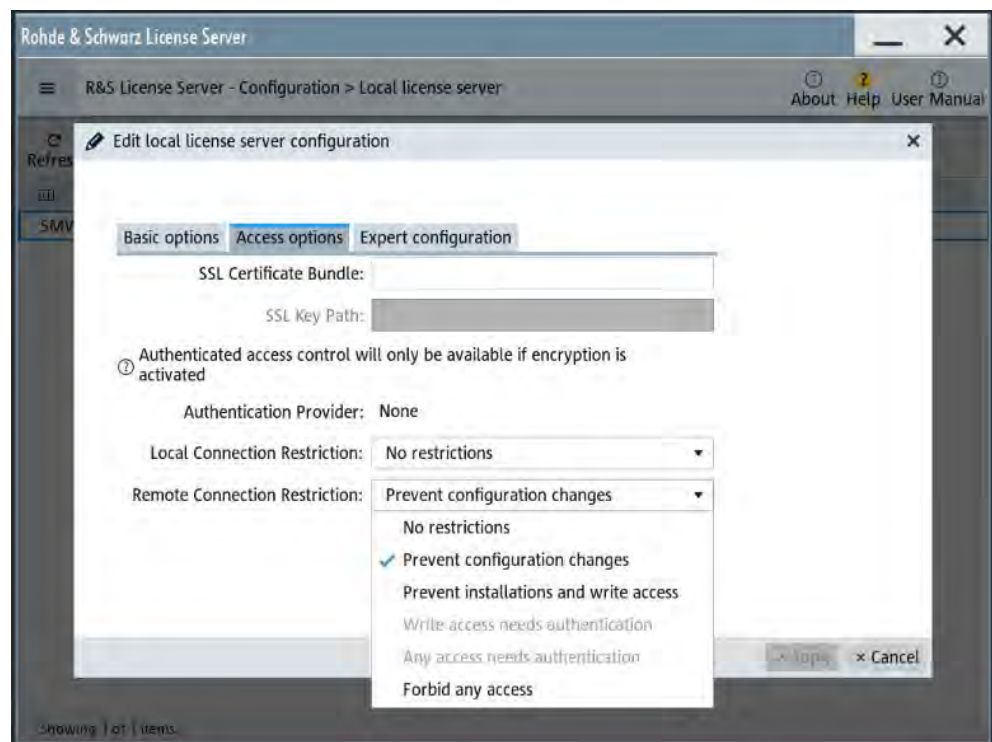

6. Confirm with "Apply" and close the dialog.

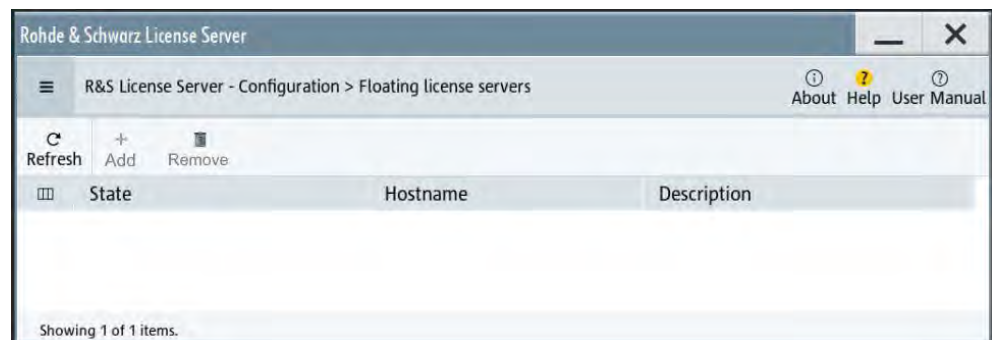

The R&S SMW200A blocks the remote connection of an external floating license server. The "Add" and "Remove" buttons are disabled (grayed out).

The restriction also disables the remote access to the "Edit" mode of the local server. You can release the restricted access only directly on the instrument.

### To enable remote connection access

If the remote connection to the floating license server is blocked, you can release the restriction or configure specific levels to prevent unauthorized access:

1. Open the license server as described in ["To open the license server"](#) on page 780.  
The onboard license server browser opens.
2. Select "Configuration" > "Local license server".
3. In the task bar, select "Edit".
4. Select the "Access options" tab.
5. Under "Remote Connection Restriction" release the access according to your requirements.

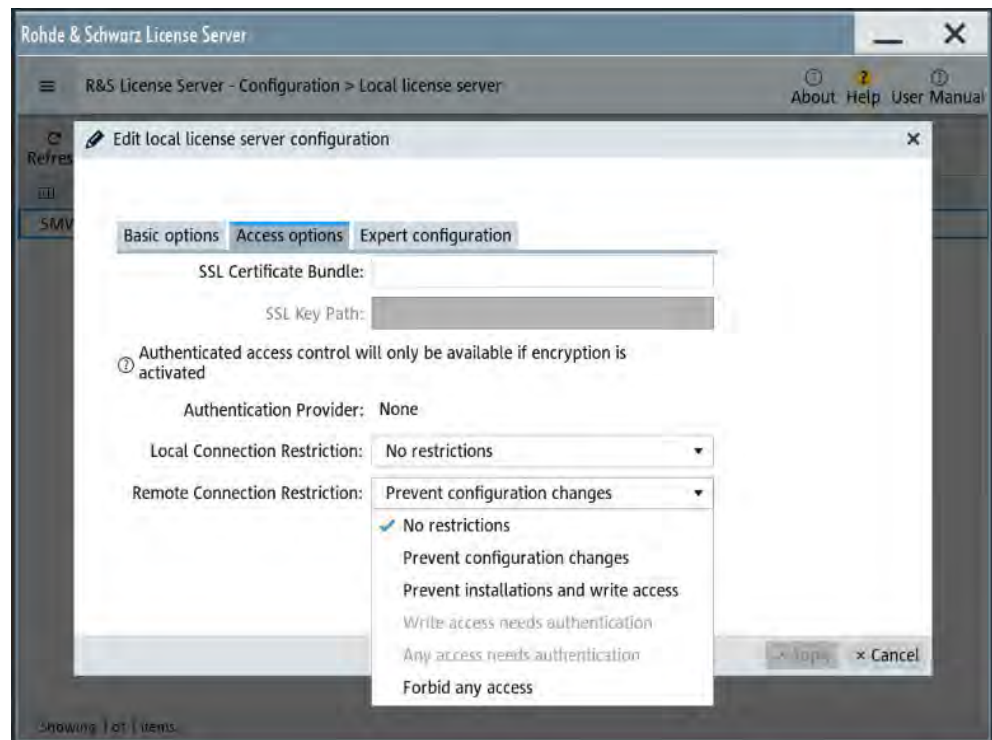

6. Confirm with "Apply" and close the dialog.  
If your selection no longer restricts the access, you can assign a floating license server.
7. Select "Configuration" > "Floating license server".

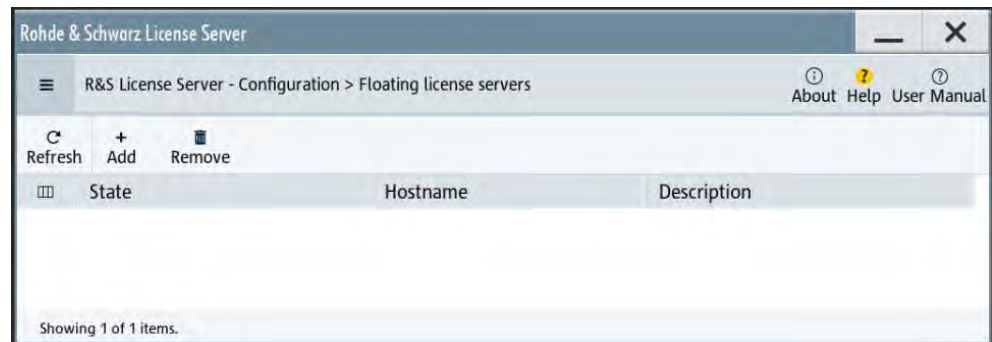

The "Add" and "Remove" buttons in the task bar are no longer blocked.

#### To add a remote connection to an external license server

1. Open the license server as described in ["To open the license server"](#) on page 780. The onboard license server browser opens.
2. Select "Configuration" > "Floating license server".
3. Select "Add".
4. Enter hostname and port of the license server you want to use.
5. Confirm with "Add".

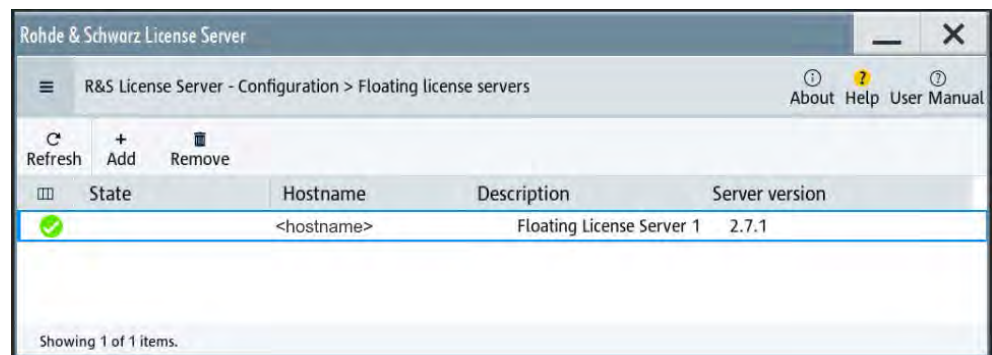

The access to the server is established.

### 12.5.3 How to occupy or extend a license

The R&S SMW200A also supports the use of currently non-occupied software licenses provided by license servers of Rohde & Schwarz. When connected to one or more license servers, you can retrieve licenses for temporary installation and use directly on the instrument.

The following description shows how to assign and handle occupied licenses.

#### To occupy an option

The example shows how to occupy an LTE option for use in the instrument.



If all licenses are occupied, the license management of the instrument blocks the settings under "Occupy Free Licenses". But you can still extend the period of already occupied licenses, the instrument lists under "Renew Occupation Period", see ["To extend the occupation period for an option in use"](#) on page 790.

1. Access:

Select "System Config > Setup > Instrument Assembly > Manage License Keys > Occupy Licenses".

Occupy Option	Designation	All Licenses from Server	Occupied by Device	Occupation Period(s)
0	<Inst>-<opt> LTE Release 8	17	2	6d, 3d
1	<Inst>-<opt> Additive White Gaussian Noise	2	2	7d, 23h

The table displays one row per option, even if more than one license is available. Column "All Licenses from Server" shows the number of free licenses.

2. To access the configuration dialog, select "Occupy Option" in the corresponding row.

The subdialog for configuring the occupancy opens.

Select Free Licenses	Occupation Period
1	3 days

In the information field of the dialog, you can see the number of available licenses for the selected option. It is not yet installed on the instrument ("Occupied: 0"), and you can occupy options up to the number of free licenses.

- In the "Select Free Licences" field, set "1".
- In the "Occupation Period" field, select e.g. "3 days".
- Confirm and assign the selection with "Occupy".

Now you can use the option on the instrument. The number of available licenses on the servers is reduced by 2 for the set occupation period.

### To extend the occupation period for an option in use

If an option is already occupied, the R&S SMW200A lists each option under "Renew Occupation Period".

- Access: Navigate to the "Occupy / Renew License: ..." dialog, as described in ["To occupy an option"](#) on page 789.

2. To extend the occupation time, select the option in section "Renew Occupation Period".
3. Set the required time, e.g. "4 days".



The maximum period is 7 days.

## 12.5.4 How to move a portable license

This example is intended to explain how to perform the required steps at the instrument.

Use a USB flash drive to transfer the license key files between the instruments and the browser.



We assume knowledge about the handling of the R&S License Manager online tool and the description of the whole process.

1. Open your browser. Enter <https://extranet.rohde-schwarz.com/service>. Select "Manage Licenses > Move Portable License".  
The first step requires the Device IDs of the source and target instruments.
2. To find out the Device IDs, proceed as follows:
  - a) On the source instrument, select "System Config > Setup > Instrument Assembly > Manage License Keys > New License > Device ID".

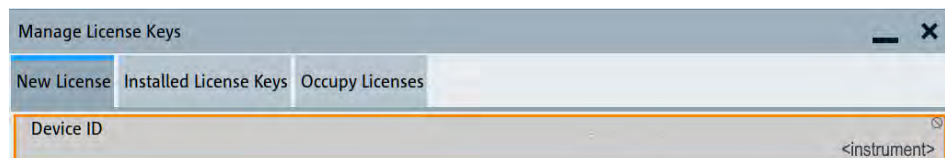

- b) On the target instrument, select "System Config > Setup > Instrument Assembly > Manage License Keys".
- c) In the "New License" tab, select "Device ID".
- d) In the browser, select "Manage Licenses > Move Portable License > Select Devices".
- e) Enter the Device IDs.

3. On the source instrument, select "System Config > Setup > Instrument Assembly > Installed License Keys > License Keys Table".
  - a) Navigate to the portable license that you want to move.
  - b) Select the "Export License to File" column.A standard file manager dialog opens.
4. Enter a filename.
5. Save the exported license key, e.g. k123\_portable\_key\_to\_move.xml.
6. In the browser, select "Manage Licenses > Move Portable License > Select License (from file)":
  - a) Select the exported license key.
  - b) Check the selection.
  - c) Create the deactivation key.
  - d) Save it to file.
7. On the source instrument, select "System Config > Setup > Instrument Assembly > Manage License Keys > New License > Import License Keys from File".  
Select the transferred deactivation key.
8. On the source instrument, select "System Config > Setup > Instrument Assembly > Manage License Keys > New Licence > Export Deactivation Response to File".
9. In the browser, go to "Manage Licenses > Move Portable License > Install Deactivation Key (from file)".
10. Enter the deactivation response of the instrument.  
The license is deactivated for the source instrument.
11. In the "Manage Licenses > Move Portable License", go to step "Create License" to generate a license key for this portable option and the selected target instrument.
  - a) Download the license key as a file.
  - b) Transfer it to the target instrument.
12. In the target instrument, select "System Config > Setup > Instrument Assembly > Manage License Keys > New License > Import License Keys from File".
13. Select the created license key file.  
The portable option is installed on the target instrument.

## 12.6 Managing extensions

This function enables you to install firmware extensions.

You get an extension file from Rohde & Schwarz for import, with the following naming convention:

```
<name>_v<xx.yy>.rsux
```



### 12.6.1 Manage extension settings

This dialog enables you to install or remove extensions. A list of installed extensions provides a quick overview.

Access:

- ▶ Select "System Config > Setup > Instrument Assembly > Manage Extensions..."  
"Install Extension" and "Remove Extension" leads you to a file manager dialog to import or erase extension files.

### 12.6.2 How to install or deinstall an extension

This example explains how to perform the required steps at the instrument.

Use a USB flash drive to provide the extension files at one of the USB interfaces of the instrument.

#### To load and install an extension

1. Select "System Config > Setup > Instrument Assembly > Manage Extensions..."
2. Select "Install Extension".
3. In the "Select Extensions Directory", select the file from the USB flash drive.
4. Select "Install".

The R&S SMW200A embeds the extension files in the instrument.

**Note:** If the file is not complete, or the filename is not correct, the R&S SMW200A aborts the import and displays a warning.

5. In the "Manage Extensions" dialog, select "Reboot" to restart the R&S SMW200A.  
After the reboot, the R&S SMW200A provides the loaded extension in the base-band block.

#### To deinstall an extension

1. Select "System Config > Setup > Instrument Assembly > Manage Extensions..."
2. Select "Remove Extension".
3. In the "Select Extensions Directory", select the file.
4. Select "Remove".

The R&S SMW200A removes the corresponding files from the instrument.

**Note:** If you have installed a permanent option, the instrument displays a warning message that you cannot remove this option.

5. Reboot the R&S SMW200A.  
The extension is deleted.

## 12.7 Using the security settings

The protection function of the R&S SMW200A provides several levels to activate particular functions like self-test or tests for service purposes specifically.

### Protection

The five protection levels are automatically active on startup that means all protected functions are locked.

To unlock a protection level:

- ▶ In the "System Config > Setup > Security > Protection" dialog, enter the correct password.

To lock a protection level:

- ▶ Clear the corresponding checkbox.

### Protection levels

The following functions are protected in the respective levels:

- **Protection level 1**  
Protects against accidental changes, like, for example, the clock and date, several internal adjustments functions and the self-test, as well as network settings or the instrument hostname.  
You can access this level with the password 123456.
- **Protection level 2**  
Unlocks protected service functions. It is accessible to authorized personnel of Rohde & Schwarz service department only.
- **Protection level 3 to 5**  
Are reserved for internal use.

### Security

The security concept of the R&S SMW200A helps you to protect your instrument against uncontrolled access and changes.



All modified security settings require that you enter the [Security Password](#) and confirm with [Accept](#).

Provided security services are:

- **General** security parameters, such as:
  - **USB storage** that secures controlled access to the mass memory of the instrument
  - **Volatile mode** that prevents information to be written to the internal memory permanently.
  - **Sanitizing** that prevents the instrument from leaving a secure environment with stored user information.

- **Annotation** frequency and amplitude prevent reading the display.
- **User interface** prevent manual operation and reading the display.
- **Password** management secures controlled user access to the instrument  
With the two-step password concept, you can assign a user-defined password for the operating system, and a security password for accessing the mass storage of the instrument.  
See [Section 12.7.5, "Password management"](#), on page 804.
- **LAN services** secure controlled network access  
You can individually lock and unlock supported LAN interface services, including the SMB client and SMB server that use versions 1.0 and 2.0 of the SMB protocol. Remote control over LAN requires you have enabled the interface, but you can disable not needed LAN services individually.  
**Note:** Disabling LAN services needed for remote control over LAN locks the instrument access persistently. You cannot address the instrument any longer.  
See [Section 12.7.4, "Configuring LAN services"](#), on page 800.
- **User interface** prevents front panel operation and/or reading the display.

For more information, see the document R&S SMW200A Instrument Security Procedures.

• <a href="#">Disk &amp; memory security settings</a> .....	795
• <a href="#">Manual operation security settings</a> .....	797
• <a href="#">Protection level settings</a> .....	799
• <a href="#">Configuring LAN services</a> .....	800
• <a href="#">Password management</a> .....	804
• <a href="#">Preventing unauthorized access</a> .....	806

### 12.7.1 Disk & memory security settings

Access:

1. Select "System Config" > "Setup" > "Security" > "Security".
2. Select "General" > "Disk & Memory".

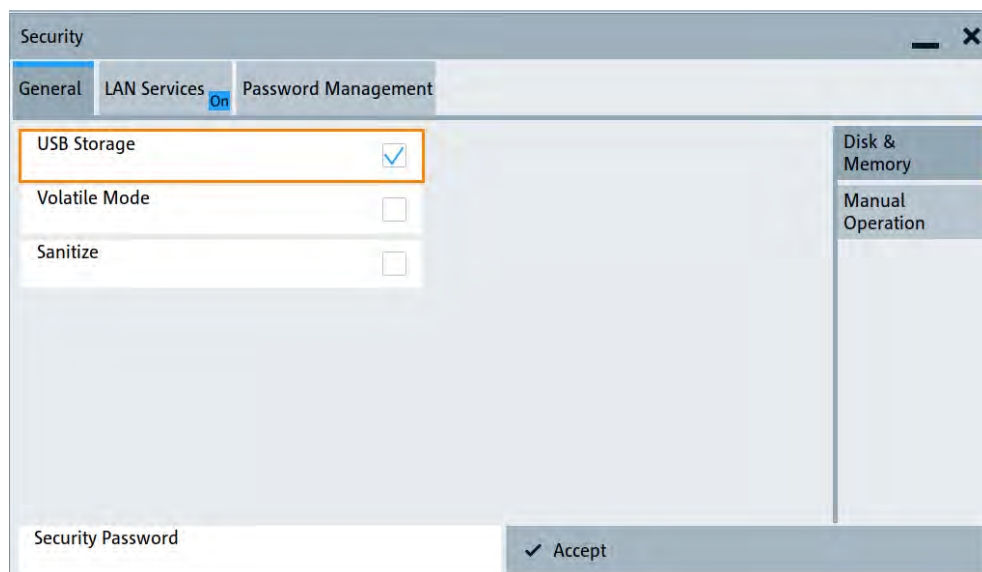

The "Disk & Memory" tab secures controlled access to the mass memory and prevents information from leaving a secure environment.

The remote commands available to control security settings are described in [Section 14.20, "SYSTEM subsystem"](#), on page 1295.

### USB Storage

Activates the access to external USB storage media.

To apply the change enter the security password and confirm with "Accept".

See [Section 11.9.4, "Using a USB storage device for file transfer"](#), on page 729.

**Note:** Remove all USB memory devices before disabling the USB storage. If any USB memory device remains connected, disabling is blocked, and the instrument returns a warning message.

### Volatile Mode

Activates volatile mode, so that no user data can be written on the internal memory permanently.

In volatile mode:

- Data that the instrument normally stores on the internal memory is redirected to volatile memory.
- The user directory is mapped to the volatile memory. You access the temporary data just as data stored in the `/var/user/`, see [Section 11.3, "Protecting data"](#), on page 707.
- Data on the internal memory cannot be changed. It is protected against modification or erasure.
- You can only save data:
  - Temporarily in the volatile memory
  - On a connected external storage device, such as a memory stick

To apply the change enter the security password and confirm with "Accept".

Enabling the volatile mode also requires a reboot, prompted by the instrument.

The icon  indicates the enabled volatile mode.

Remote command:

`:SYSTEM:SECURITY:VOLMode[:STATE]` on page 1318

### Sanitize

Executes the erase procedure that sanitizes the internal memory.

The sanitizing function makes sure that no user information is stored on the instrument when it leaves the secure environment.

To apply the change enter the security password and confirm with "Accept".

**Note:** If the instrument is subject to high security, and you have disabled volatile mode, the internal memory holds user-data, and thus poses a security risk.

See also [Section 12.7, "Using the security settings"](#), on page 794 for more information on the security concept.

Remote command:

`:SYSTEM:SECURITY:SANitize[:STATE]` on page 1317

## 12.7.2 Manual operation security settings

Access:

1. Select "System Config" > "Setup" > "Security" > "Security".
2. Select "General" > "Manual Operation".

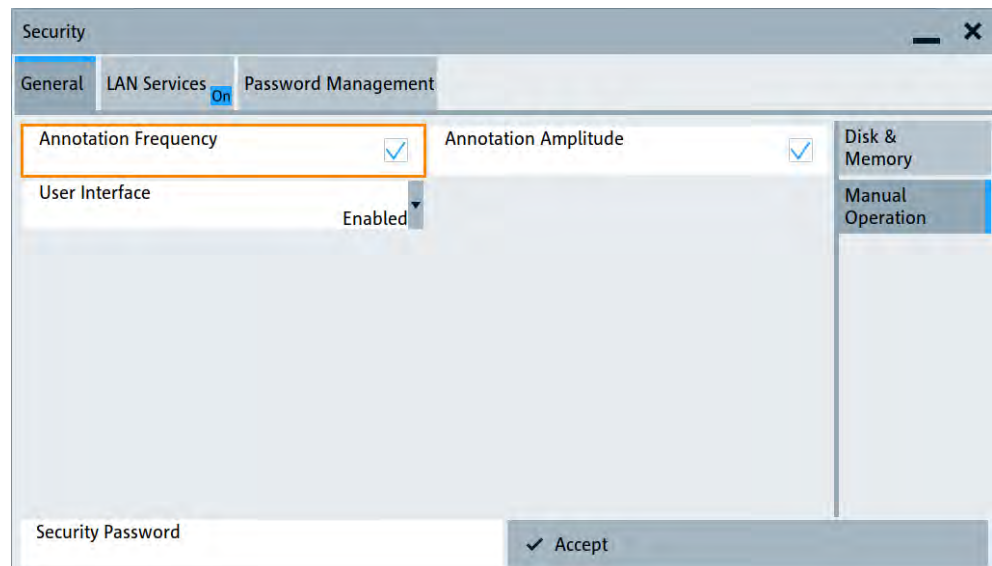

The "Manual Operation" tab enables you to lock front panel operation and/or reading the display.

The remote commands available to control security settings are described in:

- [Section 14.12, "DISPlay subsystem"](#), on page 933

- [Section 14.20, "SYSTEM subsystem"](#), on page 1295.

### Annotation Frequency

Enables the display of the currently used frequency in the status bar.

To apply the change enter the security password and confirm with "Accept".

How to: see ["To disable frequency and level indication in the status bar"](#) on page 809.

Remote command:

`:DISPlay:ANNotation:FREQuency` on page 935

### Annotation Amplitude

Enables the display of the currently selected level in the status bar.

To apply the change enter the security password and confirm with "Accept".

How to: see ["To disable frequency and level indication in the status bar"](#) on page 809.

Remote command:

`:DISPlay:ANNotation:AMPLitude` on page 935

### User Interface

Allows you to lock the controls for manual operation and the display individually.

To apply the change enter the security password and confirm with "Accept".

How to: see ["To disable the user interface"](#) on page 809.

See also [Section 12.7, "Using the security settings"](#), on page 794.

"Enabled" Enables the display and all controls for the manual operation of the instrument.

"Touchscreen Off"

Locks the touch sensitivity of the screen.

This security feature protects the instrument against unintentional change of settings by accidentally touching of the screen.

Still available controls for manual operation are:

- The keys at the front panel, including the rotary knob
- The external mouse and keyboard
- Remote operation over VNC

The instrument indicates the locked touchscreen by an icon .

Unlocking is possible via VNC, external controls or remote control.



"VNC Only"

Locks the keys at the front panel, the touchscreen and externally connected keyboard and mouse.

The display on the screen remains and shows the current settings and changes.

The instrument indicates the activated "VNC only" feature by the icon .

Unlocking is possible via VNC or turning off and on again.

- "Display Only" Locks the manual operation of the instrument. The display on the screen remains and shows the current settings and changes. This security feature protects the instrument against unauthorized access, but still shows the current settings and processes, for example when you operate the instrument via remote control.
- The function disables:
- The touchscreen functionality of the display
  - The keys at the front panel of the instrument
  - The external mouse and keyboard
- The instrument indicates the locked controls by a padlock  softkey. How to unlock: see ["Unlocking \(reactivating\) the user interface for manual operation"](#) on page 810.
- "Disabled" Locks the display and all controls for the manual operation of the instrument. This security feature protects the instrument against unauthorized reading and access, for example when you operate the instrument via remote control.
- The function disables:
- The display
  - The touchscreen
  - The keys at the front panel of the instrument
  - The external mouse and keyboard
- The screen shuts off and displays a padlock symbol  instead. How to unlock: see ["Unlocking \(reactivating\) the user interface for manual operation"](#) on page 810.
- Remote command:
- [:SYSTem:ULOCK](#) on page 1304
  - [:SYSTem:DLOCK](#) on page 1303
  - [:SYSTem:KLOCK](#) on page 1303

#### Enabling a locked user interface for manual operation

Follow the instructions listed in ["Unlocking \(reactivating\) the user interface for manual operation"](#) on page 810.

- Remote command:
- [:SYSTem:ULOCK](#) on page 1304
  - [:SYSTem:DLOCK](#) on page 1303
  - [:SYSTem:KLOCK](#) on page 1303

### 12.7.3 Protection level settings

Access:

- ▶ Select "System Config" > "Setup" > "Security" > "Protection".

Protection Level 1	<input checked="" type="checkbox"/>	Password	*****
Protection Level 2	<input checked="" type="checkbox"/>	Password	*****
Protection Level 3	<input checked="" type="checkbox"/>	Password	*****
Protection Level 4	<input checked="" type="checkbox"/>	Password	*****
Protection Level 5	<input checked="" type="checkbox"/>	Password	*****

The "Protection" dialog provides access to the unlocking of different protection levels.

Several functions in the instrument are password-protected to prevent for example accidental changes, "Protection" on page 794.

The remote commands required to unlock a protected stage are described in [Section 14.20, "SYSTem subsystem"](#), on page 1295.

#### Protection Level/Password

Unlocks the selected level of protection, if you enter the correct password.

The default protection level 1 password is 123456.

To lock the protection level again, clear the checkbox.

Remote command:

`:SYSTem:PROTect<ch> [:STATe]` on page 1306

### 12.7.4 Configuring LAN services

Access:

1. Select "System Config > Setup > Security > Security > LAN Services > Common Services".
2. **NOTICE!** Risk of loosing access over LAN. Disabling the LAN interface or the common services "SCPI over LAN", "VNC" and "HTTP" locks the remote access to the instrument.

Do not disable the LAN interface or LAN services needed for remote control while you operate the instrument remotely.

Proceed with step [step 4](#) for troubleshooting disabled services.



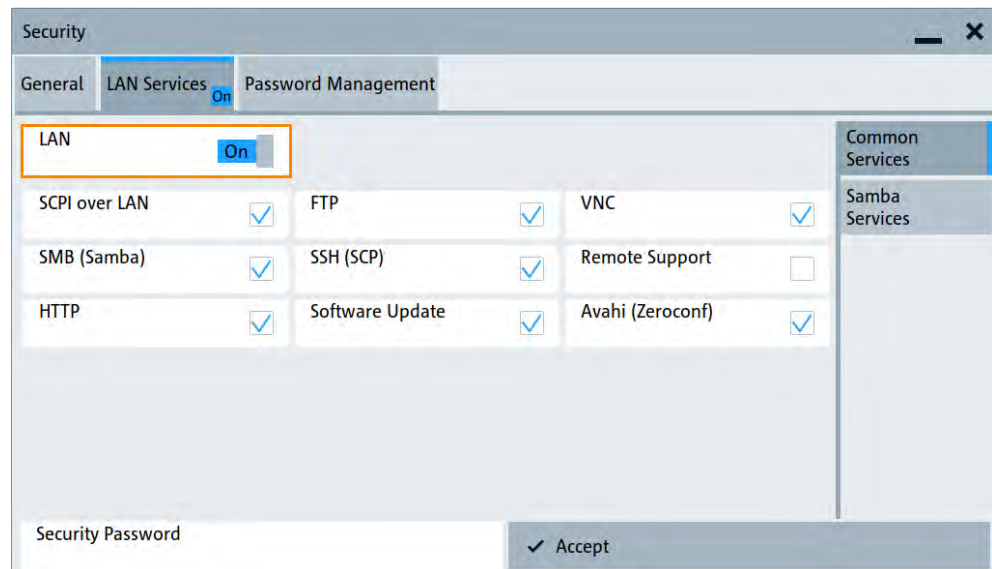

In the "Common Services" side tab, you can individually disable the supported services of the LAN interface.

3. Disable LAN services as needed.
  - a) Disable the service.
  - b) To confirm disabling, enter the security password.
  - c) Select "Accept".
4. If you have locked the access accidentally, you have the following options:
  - Update the instrument firmware using ISO image (`<instrument>_<version-number>.iso`).
 

**Note:** A firmware update with the ISO image resets the instrument. The instrument reset dismisses user-specific configurations and deletes user data. Contact the Rohde & Schwarz (<https://www.rohde-schwarz.com/support>) to get the ISO image.
  - Ship the instrument to your local service department. The service center experts can enable the remote access over LAN without losing user-specific settings and data. See [www.services.rohde-schwarz.com](http://www.services.rohde-schwarz.com).
5. Select "System Config > Setup > Security > Security > LAN Services > Samba Services".

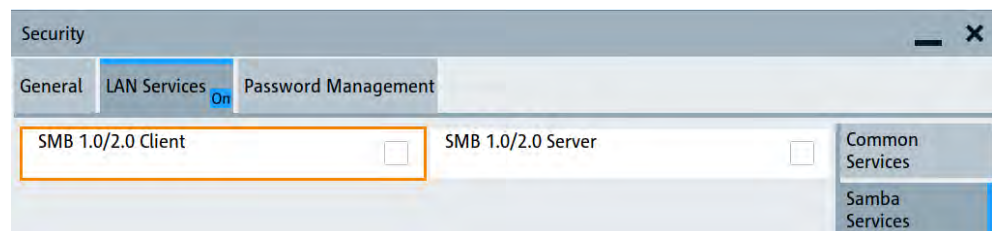

In the "Samba Services" side tab, you can activate former versions of the SMB client and SMB server.

The remote commands available to control security settings are described in [Section 14.20, "SYSTem subsystem"](#), on page 1295.

How to:

- ["To disable LAN access in general"](#) on page 807
- ["To disable LAN services individually"](#) on page 808
- ["To enable SMB version 1.0/2.0 client and server"](#) on page 809

Common Services.....	802
L LAN.....	802
L LAN Services.....	802
Samba Services.....	803
L SMB 1.0/2.0 Client.....	804
L SMB 1.0/2.0 Server.....	804
Security Password.....	804
Accept.....	804

### Common Services

Enables the LAN interface and supported LAN interface services.

#### LAN ← Common Services

Enables the LAN interface in general, and thus provides remote access over all unlocked services.

Remote command:

`:SYSTem:SECurity:NETWork[:STATe]` on page 1317

#### LAN Services ← Common Services

Enables the supported LAN interface services individually.

"SCPI over LAN"

Access over LAN to control the instrument remotely, by using SCPI (Standard Commands for Programmable Instruments) commands. See also ["To set up the controller with R&S VISA"](#) on page 865 and ["To start remote control with R&S VISA"](#) on page 868

Remote command:

`:SYSTem:SECurity:NETWork:SOE[:STATe]` on page 1316

"VNC"

Access over VNC (Virtual Network Computing) interface, a graphical desktop sharing system that uses RFB protocol to control the instrument remotely.

See also [Section 13.10, "Setting up remote operation over VNC"](#), on page 884.

Remote command:

`:SYSTem:SECurity:NETWork:VNC[:STATe]` on page 1317

- "SSH (SCP)" Access over SSH (Secure Shell), a network protocol for secure data communication.  
Remote command:  
[:SYSTem:SECurity:NETWork:SSH\[:STATe\]](#) on page 1316
- "Remote Support"  
Remote support over SSH (SCP).  
The service provides communication for service purposes only.  
Remote command:  
[:SYSTem:SECurity:NETWork:REMSupport\[:STATe\]](#)  
on page 1315
- "HTTP" Access with HTTP (Hyper Text Transfer Protocol), the application protocol for hypermedia information systems.  
Remote command:  
[:SYSTem:SECurity:NETWork:HTTP\[:STATe\]](#) on page 1314
- "FTP" Access with FTP (File Transfer Protocol), used to transfer files from a host to the instrument and vice versa.  
See also [Section 11.9.2, "Accessing the file system using FTP"](#), on page 726.  
Remote command:  
[:SYSTem:SECurity:NETWork:FTP\[:STATe\]](#) on page 1314
- "SMB (Samba)"  
Access to SMB (Server Message Block), used for providing shared access to files, printers and serial ports of a network.  
See also [Section 11.9.3, "Accessing the R&S SMW200A file system using SMB \(Samba\)"](#), on page 728.  
Remote command:  
[:SYSTem:SECurity:NETWork:SMB\[:STATe\]](#) on page 1316
- "Avahi (Zeroconf)"  
Avahi, a service for automatic configuration of the instrument in a network environment.  
Remote command:  
[:SYSTem:SECurity:NETWork:AVAHi\[:STATe\]](#) on page 1314
- "Software Update"  
Allows updating the software.  
Remote command:  
[:SYSTem:SECurity:NETWork:SWUPdate\[:STATe\]](#)  
on page 1316

**Samba Services**

Enables support of SMB client and SMB server version 1.0 and 2.0 of the SMB protocol.

Support of version 1.0 and 2.0 is additional to the current SMB protocol version supported in the firmware. This firmware supports SMB protocol up to version 3.1.1.

**SMB 1.0/2.0 Client ← Samba Services**

Enables support of the SMB client compatible with SMB protocol versions 1.0 and 2.0.

**SMB 1.0/2.0 Server ← Samba Services**

Enables support of the SMB server compatible with SMB protocol versions 1.0 and 2.0.

**Security Password**

Enters the password that is required to enable or to disable the settings protected by a security password. Default is 123456.

How to: ["To change the security password"](#) on page 807

**Accept**

Applies the modified settings, provided the security password is entered and correct.

## 12.7.5 Password management

Access:

1. Select "System Config > Setup > Security > Security > Password Management > User Password".

The screenshot shows a window titled "Security" with a close button (X) in the top right corner. Below the title bar are three tabs: "General", "LAN Services" (with a blue "On" indicator), and "Password Management". The "Password Management" tab is active. The main area contains a form with the following fields:
 

- User Name:** A text box containing "instrument". To its right is a label "Valid for VNC, FTP and SMB (Samba) access".
- Old Password:** A text box.
- New Password:** A text box.
- Confirm Password:** A text box.

 On the right side of the form, there are two vertical tabs: "User Password" (which is selected) and "Security Password". At the bottom right of the form is a button with a wrench icon and the text "Change Password".

In this tab, you can assign the security and a user-defined password.

2. Select "System Config > Setup > Security > Security > Password Management > Security Password".

The screenshot shows the same "Security" window as above, but with the "Security Password" tab selected on the right. The "User Password" tab is now greyed out. The main form area is mostly empty, with only the "Old Password" text box visible and highlighted with an orange border. The "New Password" and "Confirm Password" text boxes are present but empty. The "Change Password" button remains at the bottom right.

How to:

- ["To change the user password of the instrument"](#) on page 807.
- ["To change the security password"](#) on page 807.

### Settings:

User Name.....	805
User Password.....	805
L Old Password.....	805
L New Password.....	805
L Confirm Password.....	805
L Change Password.....	805
Security Password.....	806
L Old Password.....	806
L New Password.....	806
L Confirm Password.....	806
L Change Password.....	806

### User Name

Indicates the user name used for access to the Linux operating system and valid for VNC, FTP and SMB (Samba) access.

### User Password

Allows you to change and confirm the user password.

### Old Password ← User Password

Enters the current user password. The default password is "instrument".

**Note:** We recommend that you change the default password before connecting the instrument to a network.

How to:

- ["To change the user password of the instrument"](#) on page 807.
- ["To change the security password"](#) on page 807.

**Note:** Note that you cannot reset the password to factory state.

If you encounter problems with the password, contact the Rohde & Schwarz customer support, see [Section 15.10, "Contacting customer support"](#), on page 1354.

### New Password ← User Password

Enters the new user password.

The security password can contain decimal characters only.

### Confirm Password ← User Password

Confirms the new user password by repeating.

How to:

- ["To change the user password of the instrument"](#) on page 807.
- ["To change the security password"](#) on page 807.

### Change Password ← User Password

Changes the user password accordingly.

**Security Password**

Enables you to change and confirm the security password.

**Old Password ← Security Password**

Enters the currently used security password. The default password is '123456'.

**Note:** We recommend that you change the default password before connecting the instrument to a network.

How to:

- ["To change the user password of the instrument"](#) on page 807.
- ["To change the security password"](#) on page 807.

The security password is required when changing the status of the USB and LAN interface or other security settings.

**Note:** Note that you cannot reset the password to factory state.

If you encounter problems with the password, contact the Rohde & Schwarz customer support, see [Section 15.10, "Contacting customer support"](#), on page 1354.

**New Password ← Security Password**

Enters the new security password.

The security password can contain decimal characters only.

**Confirm Password ← Security Password**

Confirms the new security password by repeating.

How to:

- ["To change the user password of the instrument"](#) on page 807.
- ["To change the security password"](#) on page 807.

**Change Password ← Security Password**

Changes the password accordingly.

## 12.7.6 Preventing unauthorized access

The default computer name and user password are *instrument*. The user password is the password required for VNC, FTP and SMB (samba) connections. If for example, the VNC service or FTP are enabled, anyone in the network who knows the computer name and user password of the instrument can access it.

The default security password is *123456*. The security password is required when changing the status of the USB and LAN interfaces.

To prevent unauthorized access, use the following configurations exclusively or complementary:

- ["To change the user password of the instrument"](#) on page 807
- ["To change the security password"](#) on page 807
- ["To disable LAN access in general"](#) on page 807
- ["To disable LAN services individually"](#) on page 808
- ["To enable SMB version 1.0/2.0 client and server"](#) on page 809
- ["To disable frequency and level indication in the status bar"](#) on page 809

- ["To disable the user interface"](#) on page 809

If security is a concern, see the document instrument security procedures for comprehensive description.

### To change the user password of the instrument

- ▶ **Note:** We recommend that you change the default password before connecting the instrument to a network.

How to:

- ["To change the user password of the instrument"](#) on page 807.
  - ["To change the security password"](#) on page 807.
- Select "System Config > Setup > Security > Security > Password Management > User Password".
  - Enter the current password in the "Old Password" field.
  - Enter the new password in the "New Password" and "Confirm Password" fields.
  - Select "Change Password".

The user password is changed; the user name is displayed ("Security > Password Management > User Password > User Name").

### To change the security password

- ▶ **Note:** We recommend that you change the default password before connecting the instrument to a network.

How to:

- ["To change the user password of the instrument"](#) on page 807.
  - ["To change the security password"](#) on page 807.
- Select "System Config > Setup > Security > Security > Password Management > Security Password".
  - Enter the current password in the "Old Password" field.  
The default password is *123456*.
  - Enter the new password in the "New Password" and "Confirm Password" fields.
  - Select "Change Password".

### To disable LAN access in general

1. **NOTICE!** Risk of loosing access over LAN. Disabling the LAN interface or certain services lock the remote access to the instrument.  
The following services lock the remote access when disabled: "LAN", "SCPI over LAN", "VNC" and "HTTP".

If you have locked the access accidentally, you have the following options:

- Update the instrument firmware using ISO image  
(`<instrument>_<version-number>.iso`).  
**Note:** A firmware update with the ISO image resets the instrument. The instrument reset dismisses user-specific configurations and deletes user data.  
Contact the Rohde & Schwarz (<https://www.rohde-schwarz.com/support>) to get the ISO image.

- Ship the instrument to your local service department. The service center experts can enable the remote access over LAN without losing user-specific settings and data.

See [www.services.rohde-schwarz.com](http://www.services.rohde-schwarz.com).

2. Select "System Config > Setup > Security > Security".
3. Select "LAN Services > Common Services".
4. Disable "LAN" state.
5. Enter the [Security Password](#).
6. Select "Accept".

All LAN connections are blocked, including the LAN services. Communication over LAN is not possible.

#### To disable LAN services individually

1. Select "System Config > Setup > Security > Security".
2. Select "LAN Services > Common Services".
3. Uncheck all services you want to block, for example "FTP > Off" or "VNC > Off".

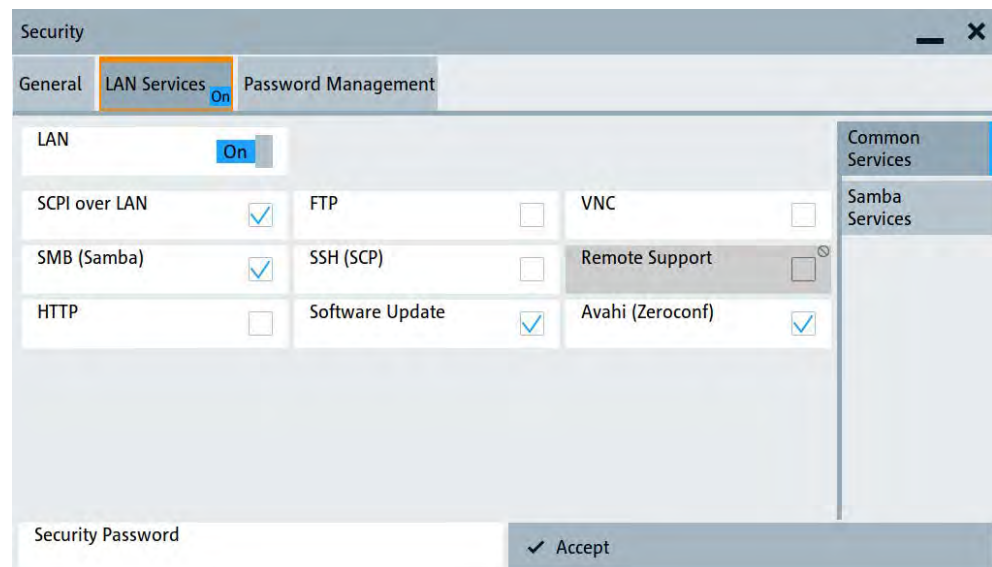

4. Uncheck the services you want to block, for example "FTP" and "VNC".
5. Enable "LAN" state, if disabled.
6. Enter the [Security Password](#).
7. Select "Accept".

Communication over LAN is possible for the enabled services only.



### To enable SMB version 1.0/2.0 client and server

By default, support of SMB client and SMB server of the SMB protocol versions 1.0 and 2.0 is disabled.

Activate support only, if needed:

1. Select "System Config > Setup > Security > Security".
2. Select "LAN Services > Samba Services".

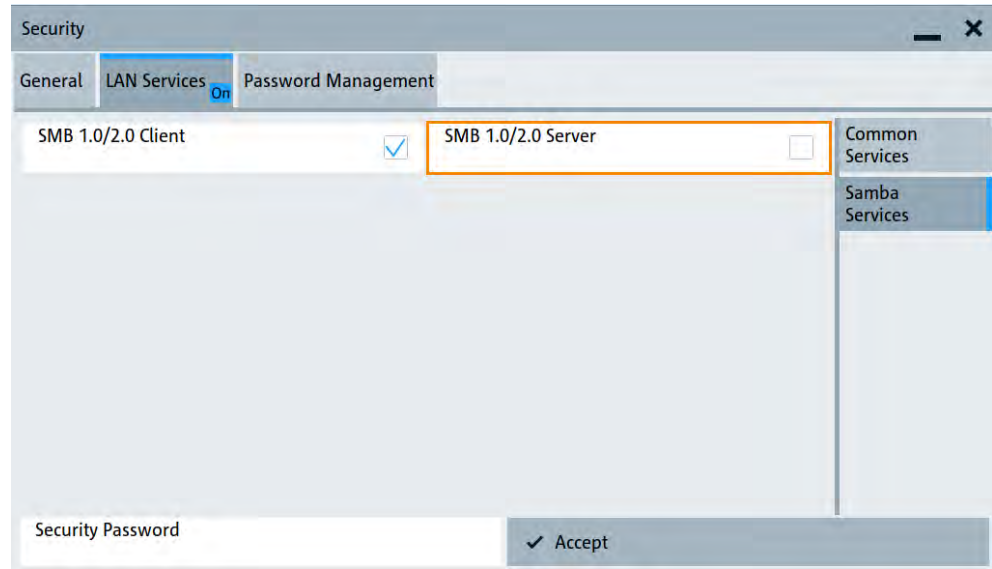

3. For example, check "SMB 1.0/2.0 Client".
4. Select "SMB 1.0/2.0 Client > On" and "SMB 1.0/2.0 Server > On".
5. Enter the [Security Password](#).
6. Select "Accept".

Enables the access for the SMB Samba client, the access for the SMB Samba server remains blocked.

### To disable frequency and level indication in the status bar

These settings are useful to prevent unauthorized personnel from reading the display, when you remotely control the instrument from a different location.

1. Select "System Config > Setup > Security > General > Manual Operation".
2. Select "Annotation Frequency > Off" or "Annotation Amplitude > Off".
3. Enter the [Security Password](#).
4. Select "Accept".

### To disable the user interface

1. Select "System Config > Setup > Security > General > Manual Operation".
2. Select "User Interface > Disabled".

3. Enter the [Security Password](#).
4. Select "Accept".

The screen shuts off and displays a padlock symbol  instead.

There are further possible configurations. For details, see "[User Interface](#)" on page 798.

### Unlocking (reactivating) the user interface for manual operation

1. In manual operation:
  - a) On the instrument's keypad or external keyboard, press any key.  
The instrument prompts you to enter the security password for unlocking.



If you press the character of the first key, the input field accepts the character immediately.

- b) Delete the entry before inserting the password.  
Enter the security password `123456`.
2. In remote control mode:
  - a) Send the command `SYST:ULOC ENABLEd` to release all locks at once.
  - b) Send the command `SYST:KLOC OFF` to unlock the keyboard and touchscreen.
  - c) Send the command `SYST:DLOC OFF` to release all locks.

Via remote control, there is no password required.

## 12.8 Undoing or restoring actions

"Undo" is a function that removes the effect of the last action on the instrument and reverts it to an older state. Conversely, "Redo" restores a previously undone action.

You can "Undo/Redo" actions according to two criteria:

- Step by step  
Gradually undo/redo the actions in reverse order as previously performed. Depending on the available memory the "Undo/Redo" steps may restore all actions.
- Multiple steps at once  
Select any specific action in the history list to "Undo/Redo" multiple actions in a single step.  
**Note:** This mode requires a system restoration file on the instrument.

**Access:**

- ▶ Select "Setup > Settings > Undo/Redo".

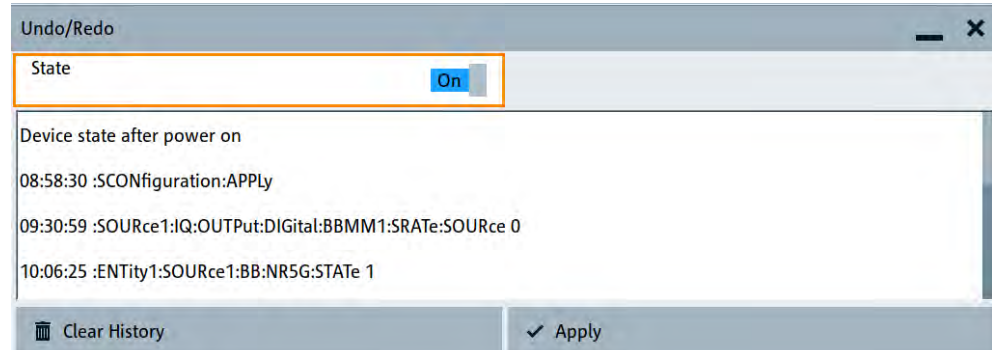

The dialog contains all functions for enabling the "Undo/Redo" functionality.

**Settings:**

State.....	811
History List.....	811
Clear History.....	811
Apply.....	811

**State**

Enables the recording of the performed actions.

**History List**

Lists the performed actions, provided "Undo/Redo" state is "On".

**Clear History**

Deletes the recorded list of the performed steps.

**Apply**

Performs the "Undo/Redo".

If you select a previously performed action of the list, all subsequent actions are undone. The list entries remain.

If you select a subsequently executed action, you can restore all the actions undone up to this state.

## 12.9 Shutting down and rebooting the instrument

On the front panel, the [On/Standby] key switches the instrument from the standby to the ready state or vice versa. In remote operation from a remote computer or in manual control, there is another possibility to shut down the instrument or to reboot the system.

Access:

- ▶ Select "System Config > Setup > Maintenance > Shut down".

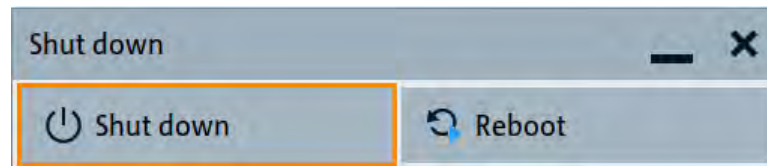

Remote control commands:

- `:SYSTem:REBoot` on page 1325
- `:SYSTem:SHUTdown` on page 1325

## 12.10 Reference

This section provides reference information on where to find the descriptions of all functions accessed via the SETUP key. This reference information is provided in successive order, i.e sorted in the order the corresponding function appears in the "Setup" dialog.

This cross-reference information is useful, if you are familiar with the documentation of other Rohde & Schwarz signal generators, like the R&S SMU.

*Table 12-7: Setup menu*

Menu item	Content	Described in ...
<b>General</b>		
System Configuration	Introduces you to the various configuration options.	<a href="#">Section 4, "Signal routing and system configuration"</a> , on page 100
Global Connectors	Explains the possible, assignable global connector interfaces.	<a href="#">Section 12.2, "Configuring local and global connectors"</a> , on page 742
Reference Freq / LO Coupling	Describes the parameters for setting the internal reference frequency.	<a href="#">Section 8.8, "Reference oscillator"</a> , on page 491
Internal Adjustments	Describes how you can calibrate your unit or individual components.	<a href="#">Section 17.3.4.1, "Internal adjustment settings"</a> , on page 1368
Baseband Powers	Explains how you can retrieve the power and peak power of the generated signal at configurable acquisition points.	<a href="#">Section 9.2, "Querying baseband power levels"</a> , on page 645
Bit/Block Error Rate	Enables you to evaluate the bit error rate of a signal. It also includes a block error rate measurement to verify the feedback signal by calculating the CRC checksum.	See the corresponding user manual of the Bit Error Rate Tester option.

Menu item	Content	Described in ...
<b>Remote Access</b>		
GPIB	Enables you to set the GPIB address of the instrument.	<a href="#">Section 13.5.3, "GPIB address settings"</a> , on page 834
Network	Contains all relevant information for the remote control of the R&S SMW200A.	<a href="#">Section 13.5.1, "Network settings"</a> , on page 830
Visa Resource Strings	Shows the VISA resource strings provided for remote control via the various interfaces.	<a href="#">Section 13.5, "Remote access settings"</a> , on page 829
Instrument Emulations	Enables you to emulate a remote control command set of another Rohde & Schwarz signal generator.	<a href="#">Section 13.5.5, "Instrument emulations settings"</a> , on page 836
LXI Status	Indicates the LAN - LXI connection parameters.	<a href="#">Section 13.6, "LXI status settings"</a> , on page 851
<b>Instrument Assembly</b>		
Hardware Config	Provides an overview of all installed hardware assemblies.	<a href="#">Section 15.8, "Checking the instrument configuration"</a> , on page 1347
Versions / Options	Contains a list of all installed software assemblies. For more information, refer to the specifications document.	<a href="#">Section 15.8, "Checking the instrument configuration"</a> , on page 1347
Manage License Keys	Explains how to enable an option for the R&S SMW200A.	<a href="#">Section 12.5, "Managing licenses and license keys"</a> , on page 770
Manage Extensions	Enables you to install firmware extensions.	<a href="#">Section 12.6, "Managing extensions"</a> , on page 792
<b>User Interface</b>		
Graphics	Describes the different ways of graphical signal display, the content, and the application of the various graphs and the available signal sources.	<a href="#">Section 9.1, "Monitoring base-band signal characteristics"</a> , on page 622
Display	Sets the GUI language.	<a href="#">Section 12.1.1, "Display and keyboard settings"</a> , on page 737
Start/Stop Display Update	Enables you to deactivate the update function of the GUI.	<a href="#">Section 12.1.3, "Display update settings"</a> , on page 739
Appearance	Disable the display of snapshot dialogs in the taskbar.	<a href="#">Section 12.1.2, "Appearance settings"</a> , on page 739
Keyboard	Sets the keyboard layout.	"Layout" on page 738
Define User Key	Describes how to assign a function to the user key.	<a href="#">Section 12.4.2, "How to assign actions to the [USER] key"</a> , on page 767

Menu item	Content	Described in ...
Hardcopy	Creates a screenshot from the current screen.	<a href="#">Section 11.10, "Creating screenshots of current settings"</a> , on page 731
<b>Security</b>		
Security	Contains security functions to protect the instrument against uncontrolled access.	<a href="#">Section 12.7, "Using the security settings"</a> , on page 794
Protection	Provides different levels of protection for certain features specifically unlock.  Provides incremental protection levels to unlock test functions, for example for service purposes.	<a href="#">Section 12.7.3, "Protection level settings"</a> , on page 799
<b>Maintenance</b>		<a href="#">Section 17.3, "Performing maintenance tasks"</a> , on page 1357
Shut down	Enables you to shut down or reboot the instrument without using the [On/Standby] front panel key.	<a href="#">Section 12.9, "Shutting down and rebooting the instrument"</a> , on page 811
Date / Time	Contains the date and time settings of the operating system.	<a href="#">Section 17.3.1, "Date and time"</a> , on page 1358
Selftest	Enables you to test the baseband functions and connections.  Enhanced settings for testing the baseband connections, and testing the IQ signal source are provided when protection level 1 is unlocked.	<a href="#">Section 17.3.5.1, "Selftest connections settings"</a> , on page 1373 <a href="#">Section 17.3.5.2, "Selftest baseband settings"</a> , on page 1374 <a href="#">Section 17.3.5.3, "Self-test DAC settings"</a> , on page 1375
Check Front Panel	Enables you to test the function of the front panel keys.	<a href="#">Section 17.3.2, "Check front panel"</a> , on page 1360
PCI-FPGA Update	Provides updating the PCI-FPGA.	<a href="#">Section 17.3.6, "FPGA/uC update settings"</a> , on page 1376
Create R&S Support Information	Creates a support file with service-related information.	<a href="#">Section 15.9, "Collecting information for technical support"</a> , on page 1353
<b>Settings</b>		
Save/Recall	Contains the main save and recall function for managing of the instrument settings.	<a href="#">Section 11.4, "Saving and recalling settings"</a> , on page 708
Factory Preset	Resets the instrument to its factory settings.	<a href="#">Section 11.2, "Restoring an instrument configuration"</a> , on page 702
Undo/Redo	Restores previously performed actions, or restores an undone action.	<a href="#">Section 12.8, "Undoing or restoring actions"</a> , on page 810
<b>Help</b>		

Menu item	Content	Described in ...
Contents Index	Accesses the embedded help system.	<a href="#">Section 3.5.6, "Getting information and help"</a> , on page 95
Export Help To User Path	Copies the online help system to the instrument's user directory/ <code>var/user/</code> .	
Tutorials	Accesses the embedded tutorials.	<a href="#">Section 3.5.6.1, "Using the tutorials"</a> , on page 97

## 13 Network operation and remote control

As an alternative to the interactive operation directly at the instrument, you can operate the R&S SMW200A also from a remote location.

The various interfaces provide flexible access to the instrument, such as *remote control*, *remote operation* or *remote file access*. These remote access modes are fundamentally different, although they are often considered interchangeable, as described in [Section 13.1, "Overview of remote access modes"](#), on page 817.

[Figure 13-1](#) shows the possibilities of the physical connection (interfaces) for remote access.

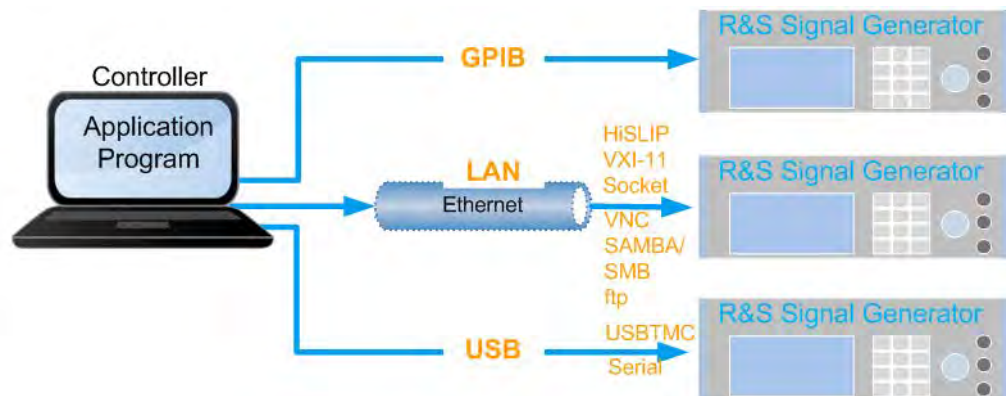

Figure 13-1: Supported remote connections



The following descriptions provide information required for operating the R&S SMW200A remotely. The information applies to all applications and operating modes supported by the instrument. Definitions specified in the SCPI standard are not provided.

For basic knowledge on remote control operation and additional information, see the following documents, available on the Rohde & Schwarz website:

- Getting started: [Remote control via SCPI](#)
- Application note [1GP72](#): "Connectivity of Rohde&Schwarz Signal Generators"
- Application note [1MA208](#): "Fast Remote Instrument Control with HiSLIP"
- Application note [1GP98](#): "SCPI Recorder Test Automation on a Fingertip"

• <a href="#">Overview of remote access modes</a> .....	817
• <a href="#">Remote control interfaces and protocols</a> .....	818
• <a href="#">Remote control programs and libraries</a> .....	823
• <a href="#">Status reporting system</a> .....	826
• <a href="#">Remote access settings</a> .....	829
• <a href="#">LXI status settings</a> .....	851
• <a href="#">LXI browser settings</a> .....	853
• <a href="#">Setting up remote control</a> .....	860



- [Using remote command scripts](#).....874
- [Setting up remote operation over VNC](#)..... 884
- [References](#).....891

## 13.1 Overview of remote access modes

This section outlines the possible access modes and their major characteristics.

### Remote control (SCPI)

- A remote PC controls the instrument, usually via VISA (Virtual Instrument Software Architecture) interfaces.
- Remote control disables the manual operation of the instrument; you can set different lock states.
- The GUI is not visible.
- Remote control commands (SCPI) perform the settings, either individually or in sequences (SCPI programs).
- Using SCPI programs is faster than the manual operation, since they automate repeating applications.

### Remote operation (VNC)

- A remote device accesses the instrument via the common platform technology VNC (Virtual Network Computing).
- The protocol allows simultaneous operation from several remote devices and the instrument nevertheless remains locally operable.
- The GUI is visible.
- To perform the settings, you can operate the instrument as with the manual control.
- During remote operation via VNC, the direct control of the instrument is not disabled.  
You can control the instrument from the front panel and via the remote computer alternately.
- Clients supporting remote operation depend on the used remote device, see [Table 13-1](#).
- How to: see [Section 13.10, "Setting up remote operation over VNC"](#), on page 884.

**Table 13-1: Supported VNC operation modes**

Remote device	VNC client	Requirements	Characteristics
Desktop (Windows, Linux, Mac™OS)	<ul style="list-style-type: none"> <li>• Ultr@VNC</li> <li>• Other dedicated client software</li> </ul>	<i>Ultr@VNC or Client Software</i> must be installed.	Fast, supports several options like full screen mode or auto-login.
	<ul style="list-style-type: none"> <li>• Any web browser</li> </ul>	<i>Java Runtime</i> must be installed and activated in the browser settings.	Fast and convenient - only the instrument address required. Java runtime is sometimes considered as security concern.

Remote device	VNC client	Requirements	Characteristics
	<ul style="list-style-type: none"> <li>Web browser with HTML5</li> </ul>	Web sockets must be supported.	Slower than the other modes. No additional installation or activation required. No security concern.
Smart device (Tablet/ smartphone)	<ul style="list-style-type: none"> <li>Dedicated client App</li> </ul>	App must be installed.	Fast, supports several options like full screen mode or auto-login.
	<ul style="list-style-type: none"> <li>Web browser with HTML5</li> </ul>	Web sockets must be supported.	Support of QR code scanning Slower than a dedicated App.

### Remote file access (FTP, SAMBA/SMB)

- A remote client accesses the instrument's file system, using the protocols FTP (file transfer protocol) and SAMBA/SMB (server message block).
- The protocols enable you to transfer files from or to the instrument and to get direct access to its file sharing directory `share`.

How to:

[Section 11.9.2, "Accessing the file system using FTP"](#), on page 726.

[Section 11.9.3, "Accessing the R&S SMW200A file system using SMB \(Samba\)"](#), on page 728

["To enable SMB version 1.0/2.0 client and server"](#) on page 809

## 13.2 Remote control interfaces and protocols

The instrument supports various interfaces for remote control. [Table 13-2](#) gives an overview on the connectivity:

**Table 13-2: Remote control interfaces and protocols**

Interface	Protocols, VISA <sup>1)</sup> address string and library	Remarks
Local area network (LAN)	<ul style="list-style-type: none"> <li><b>HiSLIP</b> High-Speed LAN Instrument Protocol (IVI-6.1) TCPIP::host address::hislip0[::INSTR] VISA</li> <li><b>VXI-11</b> TCPIP::host address[:: LAN device name][::INSTR] VISA</li> <li><b>Socket communication</b> (Raw Ethernet, simple Telnet) TCPIP::host address[:: LAN device name]::&lt;port&gt;::SOCKET VISA or socket controller</li> </ul>	The LAN connector is at the rear panel of the instrument.  The interface is based on TCP/IP, see <a href="#">Section 13.2.1, "LAN interface"</a> , on page 819 for details on the address information.
USB	<ul style="list-style-type: none"> <li><b>USBTMC</b> USB::&lt;vendor ID&gt;::&lt;product ID&gt;:: &lt;serial number&gt;[::INSTR] VISA</li> </ul>	The USB Device connector is at the rear panel of the instrument.  For a description of the interface, see <a href="#">Section 13.2.2, "USB interface"</a> , on page 821

Interface	Protocols, VISA <sup>*)</sup> address string and library	Remarks
GPIB (IEC/IEEE Bus Interface)	<ul style="list-style-type: none"> <li>VISA<sup>*)</sup> address string: GPIB::&lt;address&gt;[::INSTR] (no secondary address) VISA (optional)</li> </ul>	<p>The optional GPIB bus interface according to standard IEC 625.1/IEEE 488.1 is at the rear panel of the instrument.</p> <p>For a description of the interface, see <a href="#">Section 13.2.3, "GPIB interface (IEC/IEEE bus interface)"</a>, on page 822.</p>
<p><sup>*)</sup> VISA (Virtual Instrument Software Architecture) is a standardized software interface library providing input and output functions to communicate with instruments. A VISA installation on the controller is a prerequisite for remote control over LAN (when using VXI-11 or HiSLIP protocol), USB and serial interface. When using socket communication or the GPIB interface, VISA installation is optional. For basic information, see <a href="#">Remote control via SCPI</a>.</p>		



[www.rohde-schwarz.com/rsvisa](http://www.rohde-schwarz.com/rsvisa) provides the standardized I/O software library R&S VISA for download at the Rohde & Schwarz website [www.rohde-schwarz.com/rsvisa](http://www.rohde-schwarz.com/rsvisa).

How to: [Section 13.8, "Setting up remote control"](#), on page 860 describes how to configure the remote control interfaces.

- [LAN interface](#)..... 819
- [USB interface](#)..... 821
- [GPIB interface \(IEC/IEEE bus interface\)](#)..... 822
- [LXI browser interface](#)..... 822

### 13.2.1 LAN interface

The LAN interface of the instrument consists of a connector, a network interface card and protocols.

For remote control, the instrument and the controller PC must be connected to a common network with TCP/IP network protocol.

There are two methods to establish a LAN connection to the instrument:

- A non-dedicated network (Ethernet) connection from the instrument to an existing network.
- A dedicated network connection (Point-to-point connection) between the instrument and a single computer.

How to: [Section 3.1.7, "Connecting to LAN"](#), on page 32



#### Identifying instruments in a network

If several instruments are connected to the network, each instrument has its own IP address and associated resource string. The controller identifies these instruments by the resource string.

#### VISA resource strings

The VISA resource string is required to establish a communication session between the controller and the instrument in the LAN. The resource string is a unique identifier,

composed of the specific IP address of the instrument and some network and VISA-specific keywords.

**TCPIP::<host address>[:<LAN device name>][:INSTR]**

TCPIP = designates the network protocol  
 host address = designates the IP address or hostname of the instrument  
 [::LAN device name] = defines the protocol and the instance number of a subinstrument  
 [::INSTR] = indicates the instrument resource class (optional)

The **IP address** (host address/computer name) is used by the programs to identify and control the instrument. It is automatically assigned by the DHCP server the first time the device is registered in the network. Optionally, you can also assign its **LAN device name**.

If assigned, the IP address is displayed in the block diagram.

The following section lists the characteristics of the VISA resource strings for the corresponding interface protocols. The emphasized characters determine the protocol.



For description of the interface protocols, control commands and messages, refer to [Remote control via SCPI](#).

### HiSLIP

**TCPIP::<host address>::hislip0[:INSTR]**

hislip0 = HiSLIP device name, designates that the interface protocol HiSLIP is used (mandatory)

**hislip0** is composed of [::HiSLIP device name[,HiSLIP port]] and must be assigned.

#### Example:

TCPIP::192.1.1.2.3::hislip0

### VXI-11

**TCPIP::<host address>[:inst0][:INSTR]**

[::inst0] = LAN device name, indicates that the VXI-11 protocol is used (optional)

**inst0** currently selects the VXI-11 protocol by default and can be omitted.

#### Example:

TCPIP::192.1.1.2.3::INSTR

### Socket communication

**TCPIP::<host address>::<port>::SOCKET**

port = determines the used port number  
 SOCKET = indicates the raw network socket resource class

Socket communication requires the specification of the port (commonly referred to as port number) and of "SOCKET" to complete the resource string.

Basically, instruments from Rohde & Schwarz use port number 5025 for socket communication.

**Example:**

TCPIP::192.1.2.3::5025::SOCKET

### 13.2.2 USB interface

For remote control using USB, the controller PC and the instrument must be connected over the USB type B interface. Software for instrument control and the VISA program library must be installed on the controller.

The serial interface "RS232" enables you to connect the instrument over serial interface. You can connect to the interface by using the external USB/serial-adapter R&S TS1-USB and a serial crossover (null modem) cable.

For more information, refer to the specifications document.

VISA detects and configures the Rohde & Schwarz instrument automatically when the USB connection is established. You do not have to install a separate driver.

USBTMC (USB Test & Measurement Class Specification) is a protocol that is built on top of USB for communication with USB devices. It defines class code information of the instrument, that identifies its functionality to load the respective device driver. Using VISA library, the protocol supports service request, trigger, and other specific operations.

#### USB resource string

The resource string represents an addressing scheme that is used to establish a communication session with the instrument. It is based on the instrument address and some instrument- and vendor-specific information.

The USB resource string syntax is as follows:

**USB::<vendor ID>::<product ID>::<serial number>[::INSTR]**

USB = denotes the used interface  
 <vendor ID> = is the manufacturer ID for Rohde & Schwarz  
 <product ID> = is the product identification of the instrument  
 <serial number> = is the individual serial number at the rear of the instrument  
 [::INSTR] = indicates the instrument resource class (optional)

#### RS232 resource string

The RS232 resource string represents the addressing scheme for a device connected to the serial interface of the instrument.

The USB resource string syntax is as follows:

`ASRL<port number>[:INSTR]`

ASRL is the name of the serial interface

<port number> is the number of the serial interface

**Example:**

`ASRL1::INSTR`

### 13.2.3 GPIB interface (IEC/IEEE bus interface)

To control the R&S SMW200A over the GPIB bus, the instrument and the controller PC must be connected with a GPIB bus cable. A GPIB bus card, the card drivers and the program libraries for the used programming language must be installed on the controller.



For description of the characteristics, control commands and messages of the GPIB interface, refer to [Remote control via SCPI](#).

**GPIB address**

The controller PC addresses the instrument with the GPIB bus channel, see [Section 13.5.3, "GPIB address settings"](#), on page 834. GPIB provides channel addresses from 0 to 30.

The GPIB resource string syntax is as follows:

`GPIB://<channel>[:INSTR]`

GPIB = denotes the used interface  
 <channel address> = the used channel  
 [:INSTR] = indicates the instrument resource class (optional)

**Note:** If the VISA implementation supports the GPIB interface, you can optionally define the VISA Instrument Control Resource (INSTR). It is used to define the basic operations and attributes for a device, such as reading, writing, or triggering.

**Example:**

`GPIB::28::INSTR`

28 is the selected GPIB bus channel

### 13.2.4 LXI browser interface

The LXI browser interface allows easy configuration of the LAN and remote control of the R&S SMW200A without additional installation requirements. The instrument's LXI browser interface works correctly with all W3C compliant browsers.

See [Section 13.11.1, "LXI functionality"](#), on page 891 for more about LXI.

The LAN settings are configured using the instrument's LXI browser interface described in [Section 13.7.1, "LAN configuration"](#), on page 855.

For LXI status information in the R&S SMW200A, see [Section 13.6, "LXI status settings"](#), on page 851.

## 13.3 Remote control programs and libraries

This section shows how the remote-control programs access the instrument, and the libraries they require for the corresponding interface protocols.

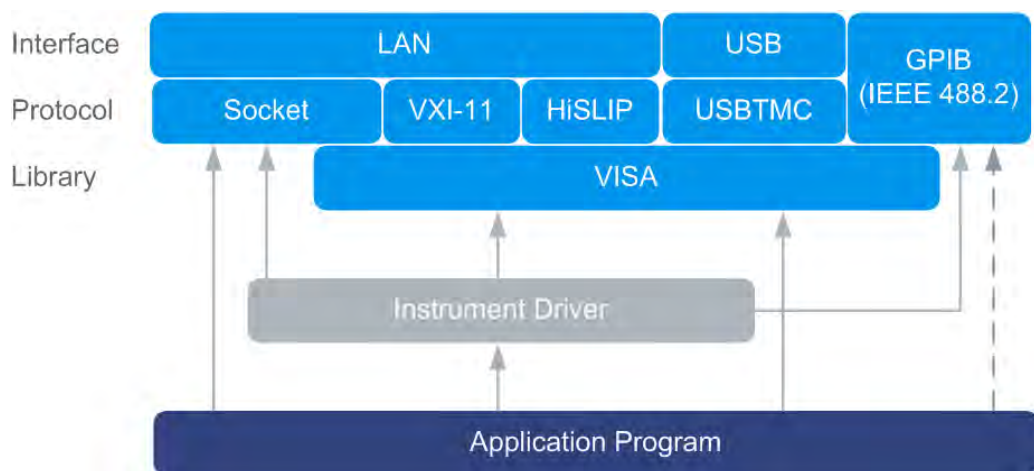

Figure 13-2: Overview of remote control interfaces, protocols and libraries

### Possible setups and access functions

The following examples give an overview of dependencies between the available libraries, the possible interfaces and protocols, and whether an instrument driver is provided. For detailed information, see the application note [1GP72](#).



#### Hostname syntax changed

The remote control program examples in this section address an instrument using its hostname. It affects all commands using `..., "TCPIP:<hostname>:...", ...`.

From FW version 3.20.200.xx, the syntax of the hostname changed to `SMW200A-<serial number>`, in contrast to the former syntax `rssmw200a<serial number>`.

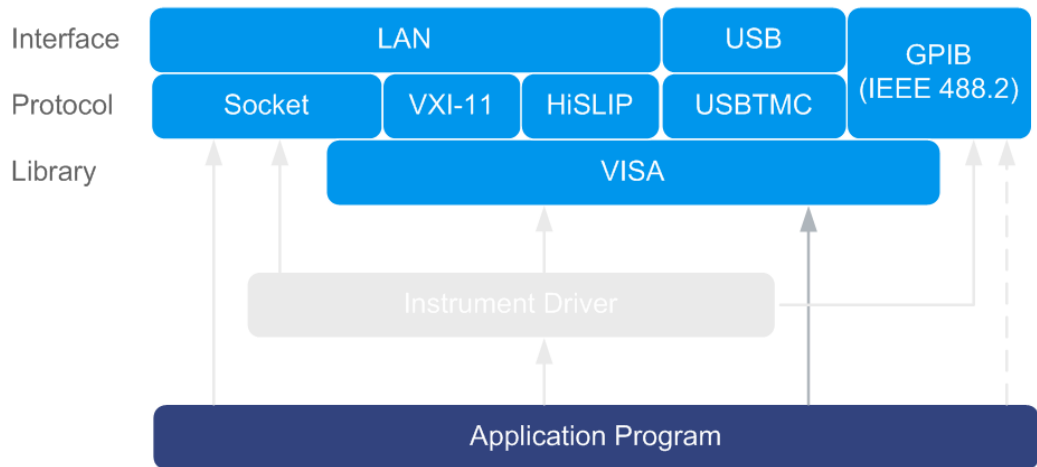
**Example: Remote control (application) program using VISA****Figure 13-3: Application program using VISA**

Protocol	Remote control program
Socket	<code>viOpen (... , "TCPIP:SMW200A-102030::5025::SOCKET", ...)</code> <code>viPrintf (... , "SOUR:FREQ 2GHz\n")</code>
VXI-11	<code>viOpen (... , "TCPIP:SMW200A-102030::inst0::INSTR", ...)</code> <code>viPrintf (... , "SOUR:FREQ 2GHz\n")</code>
HiSLIP	<code>viOpen (... , "TCPIP:SMW200A-102030::hislip0::INSTR", ...)</code> <code>viPrintf (... , "SOUR:FREQ 2GHz\n")</code>
USBTMC	<code>viOpen (... , "USB::0x0AAD::0x0092::100001::INSTR", ...)</code> <code>viPrintf (... , "SOUR:FREQ 2GHz\n")</code>
GPIB	<code>viOpen (... , "GPIB::28::INSTR", ...)</code> <code>viPrintf (... , "SOUR:FREQ 2GHz\n")</code>

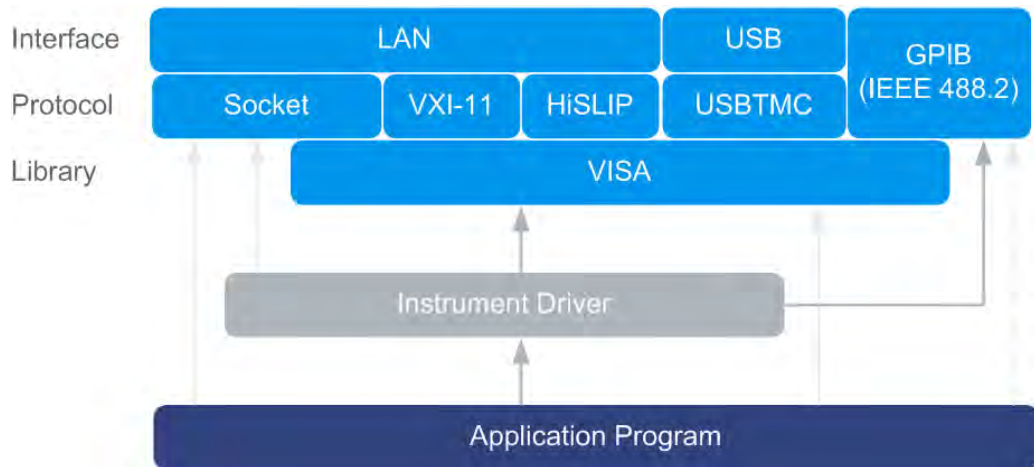

**Example: Remote control program using instrument driver (VISA available)****Figure 13-4: Application using instrument driver (VISA available)**

Protocol	Remote control program
Socket	<code>rssmw_init ("TCPIP:SMW200A-102030::5025::SOCKET", ...)</code> <code>rssmw_SetFrequency (... , 2e9)</code>
VXI-11	<code>rssmw_init ("TCPIP:SMW200A-102030::inst0::INSTR", ...)</code> <code>rssmw_SetFrequency (... , 2e9)</code>
HiSLIP	<code>rssmw_init ("TCPIP:SMW200A-102030::hislip0::INSTR", ...)</code> <code>rssmw_SetFrequency (... , 2e9)</code>
USBTMC	<code>rssmw_init ("USB::0x0AAD::0x0092::100001::INSTR", ...)</code> <code>rssmw_SetFrequency (... , 2e9)</code>
GPIB	<code>rssmw_init ("GPIB::28::INSTR", ...)</code> <code>rssmw_SetFrequency (... , 2e9)</code>

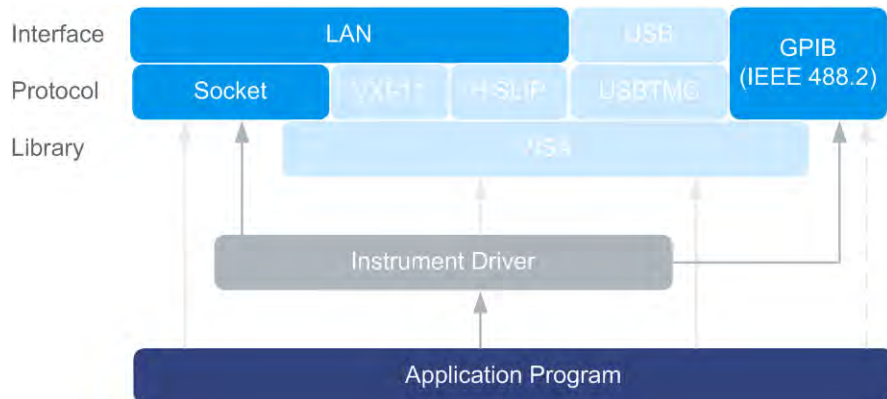
**Example: Remote control program using instrument driver (VISA not available)***Figure 13-5: Remote control program using instrument driver (VISA not available)*

Protocol	Remote control program
Socket	<pre>rssmw_init ("TCPIP:SMW200A-102030::5025::SOCKET", ...) rssmw_SetFrequency (... , 2e9)</pre>
GPIB	<pre>rssmw_init ("GPIB::28::INSTR", ...) rssmw_SetFrequency (... , 2e9)</pre>

## 13.4 Status reporting system

The status reporting system stores all information on the current operating state of the instrument and on errors which have occurred. This information is stored in the status registers and in the error queue. You can query the status of the registers with the remote commands of the [Section 14.21, "STATUS subsystem"](#), on page 1326.

### 13.4.1 Overview of the status registers

The [Figure 13-6](#) shows the hierarchical structure of information in the status registers (ascending from left to right).

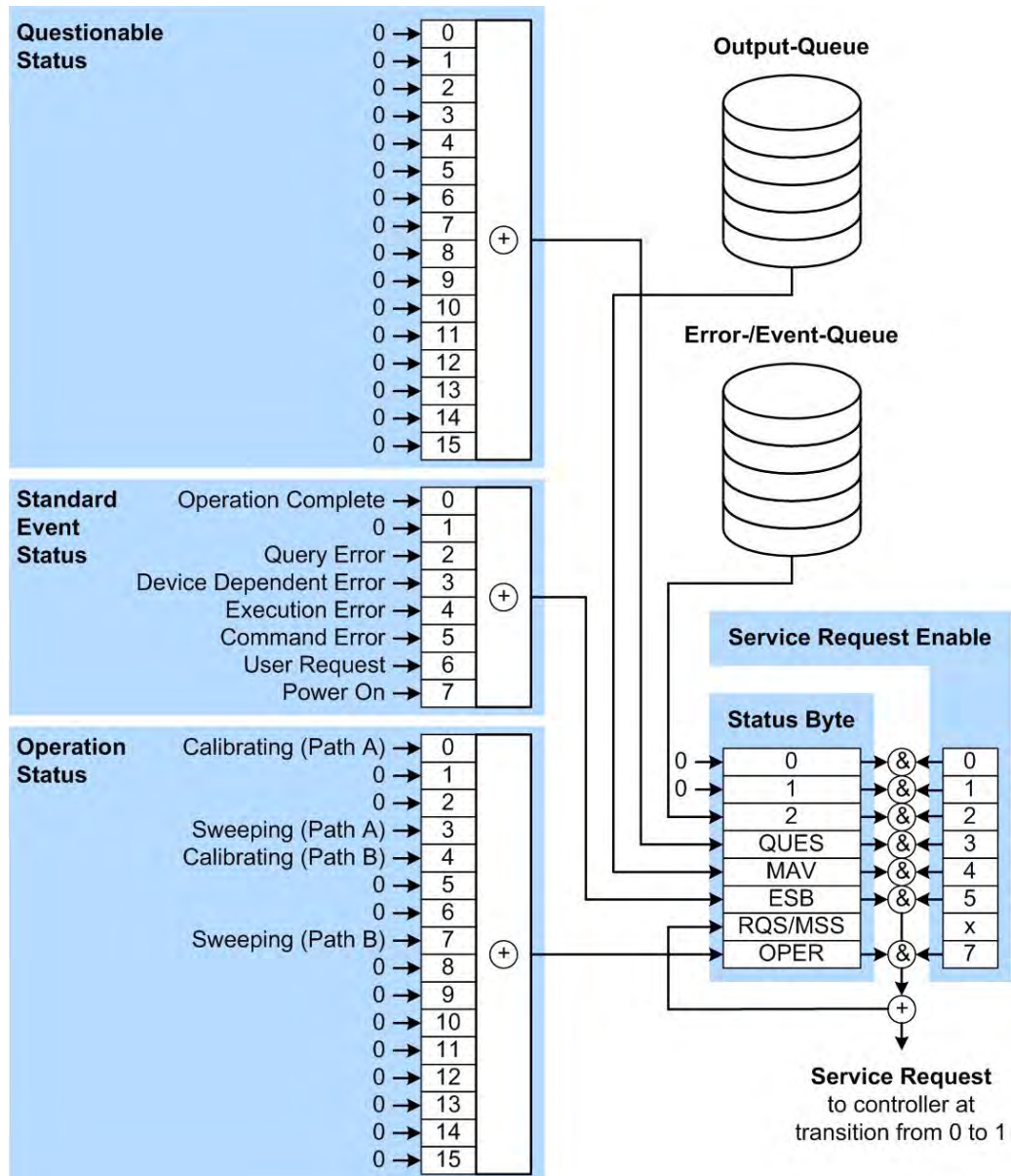

Figure 13-6: Graphical overview of the status registers hierarchy

- OPER = Operation Status Summary Bit
- RQS/MSS = Service Request Generation
- ESB = Standard Event Status Summary Bit
- MAV = Message Available in Output Queue
- QUES = Questionable Status Summary Bit
- 2 = Error- /Event-Queue
- 1, 0 = not used



The following sections describe the instrument-specific bit assignments of the operation status and the questionable status registers.

For more information, see:

- [Remote control via SCPI](#): provides general information on the status reporting system of Rohde & Schwarz instruments. This document also provides information on the standard event status register and the error queue.
- SCPI standard documentation for comprehensive information on the standard

### 13.4.2 Instrument-specific status operation register

The condition part contains information on currently executed actions. The event part covers information on the actions performed since the last readout of the register.

To read the register, use the query commands `:STATus:OPERation:CONDition?` on page 1326 and `:STATus:OPERation[:EVENT]` on page 1327.

The remote commands for the status questionable register are described in [Section 14.21, "STATus subsystem"](#), on page 1326.

**Table 13-3: Assignment of the bits used in the operation status register**

Bit No.	Meaning
0	Calibrating
4	The bit is set during the calibration phase.
1–2 5–6	Not used
3 7	Sweeping This bit is set during a sweep in automatic or single mode.
8–15	Not used

### 13.4.3 Instrument-specific status questionable register

This status register contains information on questionable instrument states. Questionable states occur when the instrument is not operated in compliance with its specifications.

To read the register, use the query commands `:STATus:QUEStionable:CONDition` on page 1328 or `:STATus:QUEStionable[:EVENT]` on page 1328.

The remote commands for the status questionable register are described in [Section 14.21, "STATus subsystem"](#), on page 1326.

**Table 13-4: Assignment of the bits used in the questionable status register**

Bit No.	Meaning
0–15	Not used

### 13.4.4 Reset values of the status reporting system

The following table contains the different commands and events causing the status reporting system to be reset. None of the commands, except for \*RST and SYSTem:PRESet affect the functional instrument settings. In particular, DCL does not change the instrument settings.

**Table 13-5: Resetting the status reporting system**

Event	Switching on supply voltage Power-On-Status-Clear		DCL, SDC (Device Clear, Selected Device Clear)	*RST or SYSTem: PRESet	STATus: PRESet	*CLS
	0	1				
Clear STB, ESR	-	Yes	-	-	-	Yes
Clear SRE, ESE	-	Yes	-	-	-	-
Clear PPE	-	Yes	-	-	-	-
Clear error queue	Yes	Yes	-	-	-	Yes
Clear output buffer	Yes	Yes	Yes	1)	1)	1)
Clear command processing and input buffer	Yes	Yes	Yes	-	-	-

1) The first command in a command line that immediately follows a <PROGRAM MESSAGE TERMINATOR> clears the output buffer.

## 13.5 Remote access settings

This section describes the settings required for accessing and configuring the provided remote control interfaces. It includes network settings, access addresses, emulation settings for using the command sets of other generators, and the access with smart devices.

- [Network settings](#).....830
- [VISA resource strings settings](#).....833
- [GPIB address settings](#).....834
- [RS232 settings](#).....835
- [Instrument emulations settings](#).....836
- [Active remote connection settings](#).....838
- [Closed remote connection settings](#).....839
- [HUMS settings](#).....840
- [HUMS enhanced settings](#).....843
- [QR code](#).....851

## 13.5.1 Network settings

Access:

- ▶ Select "System Config" > "Remote Access" > "Network".

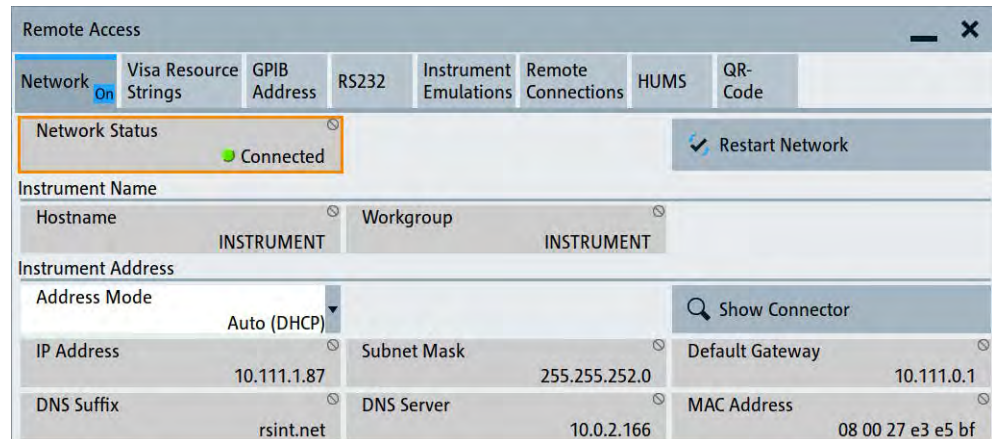

The "Network" dialog provides settings of the general network environment, and specific identification parameters of the instrument in the network. If necessary, you can configure the instrument address settings manually.

How to: ["To assign the instrument address manually"](#) on page 862.

The remote commands required to configure the network remotely are described in [Section 14.20, "SYSTEM subsystem"](#), on page 1295.

### Settings:

<a href="#">Network Status</a> .....	830
<a href="#">Restart Network</a> .....	830
<a href="#">Hostname</a> .....	831
<a href="#">Workgroup</a> .....	831
<a href="#">Address Mode</a> .....	831
<a href="#">IP Address</a> .....	831
<a href="#">Subnet Mask</a> .....	832
<a href="#">Default Gateway</a> .....	832
<a href="#">DNS Suffix</a> .....	832
<a href="#">DNS Server</a> .....	832
<a href="#">MAC Address</a> .....	832

### Network Status

Indicates that the instrument is connected to the network.

Remote command:

:SYSTem:COMMunicate:NETWork:STATus? on page 1309

### Restart Network

Terminates the network connection of the instrument and sets it up again. You can use this function to fix network problems.

**Note:** This function restarts only the connection of the instrument to the network. It does not impact the network itself.

Remote command:

`:SYSTem:COMMunicate:NETWork:REStart` on page 1309

### Hostname

Displays the hostname.

Each instrument is delivered with an assigned hostname, a logical name which can be used instead of the IP address. With the default network settings, the IP address is allocated by the DHCP server. This address can change each time the instrument is reconnected. Unlike the IP address, the hostname name does not change.

#### Note:

This function is password-protected. Unlock the protection level 1 to access it.

- We recommend that you do not change the default network settings or the host-name to avoid problems with the network connection.  
If you change the hostname, be sure to use a unique name.
- Note also, that from **FW version 3.20.200.xxx and later** the syntax of the host-name (computer name) has changed, according to recent conventions of Rohde & Schwarz.

The modification affects:

- Instruments supplied with this FW
- Performed factory preset on an instrument with updated FW

Remote command:

`:SYSTem:COMMunicate:NETWork[:COMMON]:HOSTname` on page 1309

### Workgroup

Sets the individual windows workgroup name of the R&S SMW200A. This parameter is required in case the instrument is integrated in a windows network.

This function is password-protected. Unlock the protection level 1 to access it.

Remote command:

`:SYSTem:COMMunicate:NETWork[:COMMON]:WORKgroup` on page 1310

### Address Mode

Selects the mode for assigning the IP address.

"Auto (DHCP)"

Assigns the IP address automatically, provided the network supports DHCP (Dynamic Host Configuration Protocol).

"Static"

Enables you to assign the IP address manually.

Remote command:

`:SYSTem:COMMunicate:NETWork:IPAddress:MODE` on page 1308

### IP Address

Displays the IP address of the instrument in the network.

To assign the IP address manually, see ["To assign the instrument address manually"](#) on page 862.

Remote command:

`:SYSTem:COMMunicate:NETWork:IPADdress` on page 1308

### Subnet Mask

Displays the bit group of the subnet in the host identifier.

The TCP/IP protocol is preinstalled with the subnet mask 255.255.255.0. If the DHCP server is available [Address Mode A AUTO \(DHCP\)](#), the setting is read-only. The subnet mask consists of four number blocks separated by dots. Each block contains 3 numbers in maximum (e.g. 100.100.100.100), but also one or two numbers are allowed in a block (as an example see the preinstalled address).

To assign the subnet mask manually, select [Address Mode > Static](#).

**Note:** When assigning the subnet mask manually, make sure that the address matches with the subnet mask of the controlling host interface.

How to: "[To assign the instrument address manually](#)" on page 862.

Remote command:

`:SYSTem:COMMunicate:NETWork[:IPADdress]:SUBNet:MASK` on page 1310

### Default Gateway

Displays the gateway address.

This address identifies the router on the same network as the instrument that is used to forward traffic to destinations beyond the local network.

To assign the gateway address manually, select [Address Mode > "Static"](#).

Remote command:

`:SYSTem:COMMunicate:NETWork[:IPADdress]:GATeway` on page 1310

### DNS Suffix

Displays the primary DNS (Domain Name System) suffix, that means the DNS name without the hostname part.

The DNS system uses the suffix for registration and name resolution for unique identification of the instrument in the entire network.

To assign the DNS suffix manually, select [Address Mode > "Static"](#).

Remote command:

`:SYSTem:COMMunicate:NETWork[:COMMON]:DOMain` on page 1309

### DNS Server

Determines the preferred server for name resolution. The DNS server contains the underlying numerical values that are required for name resolution of the hostname as part of the IP address.

To select the DNS server manually, select [Address Mode > "Static"](#).

Remote command:

`:SYSTem:COMMunicate:NETWork[:IPADdress]:DNS` on page 1310

### MAC Address

Indicates the MAC (Media Access Control) address, a unique identifier of the network adapter in the R&S SMW200A.



Remote command:

:SYSTem:COMMunicate:NETWork:MACAddress on page 1308

## 13.5.2 VISA resource strings settings

Access:

- ▶ Select "System Config" > "Remote Access" > "Visa Resource Strings".

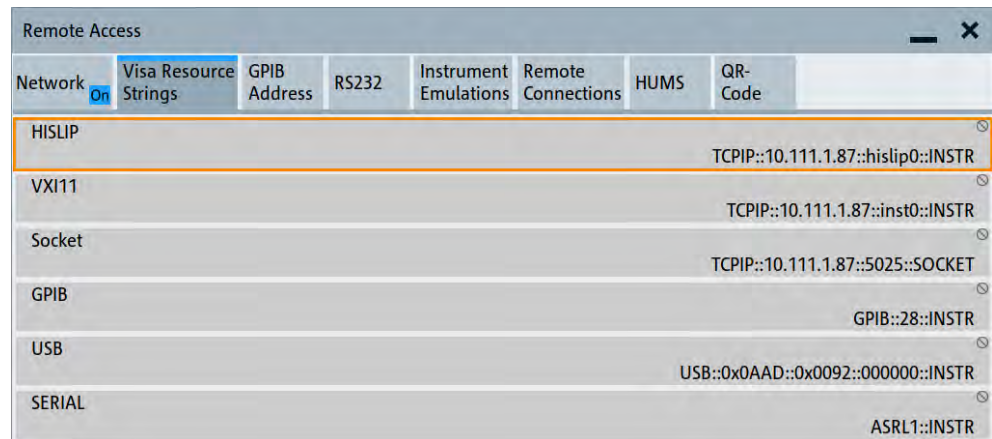

The "Visa Resource String" dialog displays the VISA resource strings provided for remote control over the different interfaces.

The remote commands required to query the address information remotely are described in [Section 14.20, "SYSTem subsystem"](#), on page 1295.

### Settings:

<a href="#">HISLIP</a> .....	833
<a href="#">VXI11</a> .....	833
<a href="#">Socket</a> .....	834
<a href="#">GPIB</a> .....	834
<a href="#">USB</a> .....	834
<a href="#">SERIAL</a> .....	834

### HISLIP

Displays the visa resource string for remote control with HiSLIP protocol.

See also [Section 13.2.1, "LAN interface"](#), on page 819.

Remote command:

:SYSTem:COMMunicate:HISLip:RESource? on page 1307

### VXI11

Displays the visa resource string for remote control over LAN.

See also [Section 13.2.1, "LAN interface"](#), on page 819.

Remote command:

`:SYSTem:COMMunicate:NETWork:RESource?` on page 1308

### Socket

Displays the visa resource string for remote control over LAN, using the socket communication protocol.

See also [Section 13.2.1, "LAN interface"](#), on page 819.

Remote command:

`:SYSTem:COMMunicate:SOCKet:RESource?` on page 1311

### GPIB

Displays the visa resource string for remote control over the GPIB interface.

See also [Section 13.2.3, "GPIB interface \(IEC/IEEE bus interface\)"](#), on page 822.

Remote command:

`:SYSTem:COMMunicate:HISLip:RESource?` on page 1307

### USB

Displays the visa resource string for remote control over the USB interface.

See also [Section 13.2.2, "USB interface"](#), on page 821.

Remote command:

`:SYSTem:COMMunicate:USB:RESource?` on page 1312

### SERIAL

Displays the visa resource string for remote control over the serial interface.

See also [Section 13.2.2, "USB interface"](#), on page 821.

Remote command:

`:SYSTem:COMMunicate:SERial:RESource?` on page 1311

## 13.5.3 GPIB address settings

Access:

- Select "System Config" > "Remote Access" > "GPIB Address".

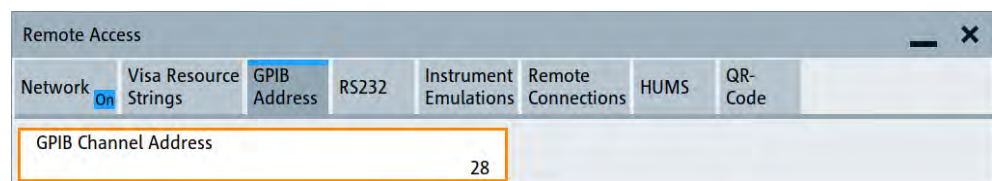

The "GPIB Address" enables you to select the channel for remote control over the IEC/IEE bus interface.

The remote command to configure the setting remotely is described in [Section 14.20, "SYSTem subsystem"](#), on page 1295.

**Settings:**

GPIB Channel Address..... 835

**GPIB Channel Address**

Sets the GPIB (IEC/IEEE bus) channel address for the connected instrument.

Remote command:

:SYSTem:COMMunicate:GPIB[:SELF]:ADDRes on page 1307

**13.5.4 RS232 settings**

Access:

- ▶ Select "System Config > Remote Access > RS232".

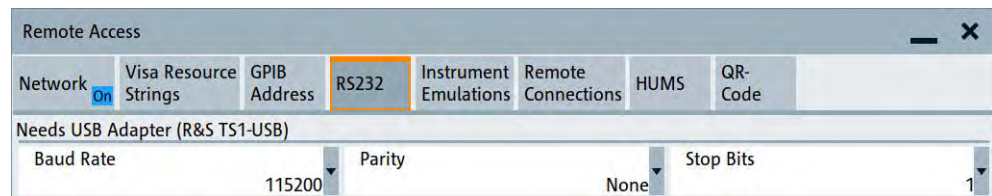

The "RS232" dialog enables you to control the instrument over a serial interface using a USB adapter. The controller and the instrument must be connected with the external USB/serial-adapter R&S TS1-USB and a serial crossover (null modem) cable. The USB connection requires the Visa library to be installed on the controller. Visa detects and configures the R&S SMW200A automatically when the USB connection is established.

For more information, refer to the specifications document.

The remote commands required to configure the parameters remotely are described in [Section 14.20, "SYSTem subsystem"](#), on page 1295.

**Settings:****Baud Rate**

Sets the baudrate for the serial remote control interface.

Remote command:

:SYSTem:COMMunicate:SERial:BAUD on page 1310

**Parity**

Sets the parity for the serial remote control interface.

Remote command:

:SYSTem:COMMunicate:SERial:PARity on page 1311

**Stop Bits**

Sets the number of stop bits for the serial remote control interface.

Remote command:

`:SYSTem:COMMunicate:SERial:SBITs` on page 1311

## 13.5.5 Instrument emulations settings

### About instrument emulations

You can remotely control the R&S SMW200A using the command set of another signal generator. With this function you can, for example, replace a signal generator with an R&S SMW200A in an automated test setup, without adjusting the command scripts used.



The R&S SMW200A also covers command sets of Rohde & Schwarz signal generators. To achieve optimal compatibility when replacing an instrument, we recommend that you select the emulation command set for the corresponding signal generator.

You find the remote control command sets supported by the R&S SMW200A in a selection list.

The selected instrument also defines the identification string that is retrieved with query `*IDN?`. If necessary, use the parameter `Mode` and `IDN String` to change this string.

As any other parameter, the remote control command set can also be changed remotely by the command `:SYSTem:LANGuage`.

While working in an emulation mode, the R&S SMW200A specific command set is disabled and the SCPI command `:SYSTem:LANGuage` is discarded.

To return to the SCPI command set of the R&S SMW200A, use the corresponding command of the selected command set.

If for example an HP generator is emulated, the HP command `EX` returns to the instrument-specific GPIB command set.

Access:

- ▶ Select "System Config" > "Remote Access" > "Instrument Emulations".

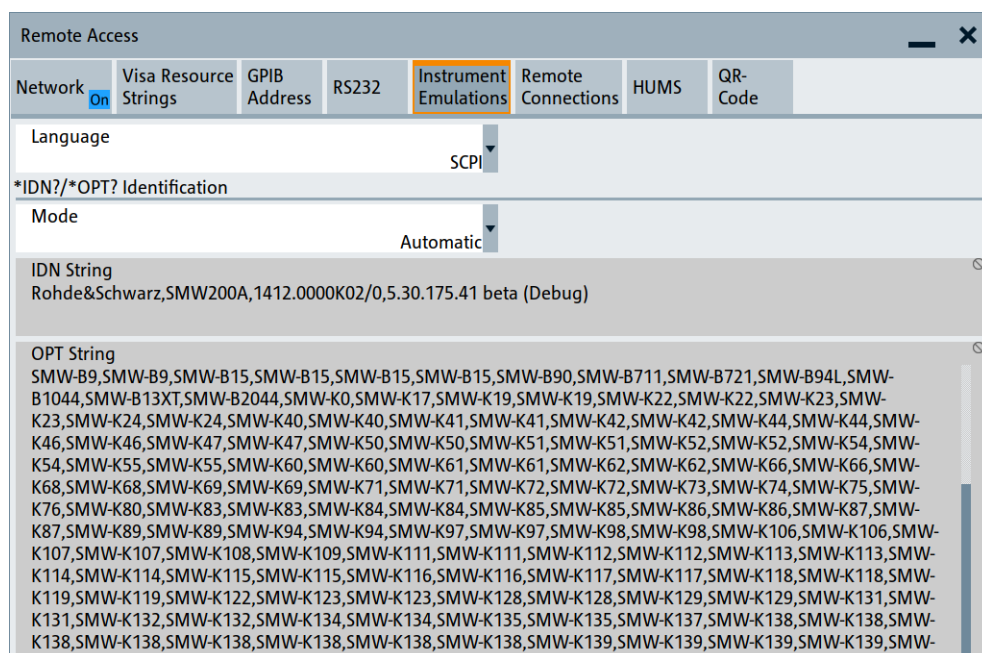

The "Instrument Emulations" dialog enables you to emulate a remote control command set of another signal generator.

The remote commands required to configure the emulation settings remotely are described in [Section 14.20, "SYSTEM subsystem"](#), on page 1295.

### Settings:

#### Language

Selects the instrument whose remote command set is emulated by the R&S SMW200A.

Remote command:

:SYSTEM:LANGuage on page 1313

#### Mode

Selects the way the instrument identification is performed.

"Automatic" Sets the "IDN String" and the "OPT String" automatically for the instrument selected with the parameter [Language](#).

"User Defined" Enables you to define the "IDN String" and the "OPT String".

Remote command:

:SYSTEM:IDENTification on page 1312

#### Set to Default

In "Mode > User Defined", resets the \*IDN and \*OPT strings.

Remote command:

:SYSTEM:IDENTification:PRESet on page 1312

**IDN String**

Indicates the identification string of the instrument when queried with the common command `*IDN?`.

In addition to the preset values, you can define your own identification string so that each generator uses an individual identification, like `My_SigGen` for instance, see [Mode](#).

Remote command:

`*IDN?` on page 899

`:SYSTEM:IRESpOse` on page 1313

**OPT String**

Indicates the option string of the instrument as queried with common command `*OPT?`.

In [Mode](#) > "User Defined", you can define your own option string. A query responds with this option string instead of the automatically created option string.

Remote command:

`*OPT?` on page 900

`:SYSTEM:ORESpOse` on page 1313

**13.5.6 Active remote connection settings**

This dialog displays the active SCPI and TCP/IP connections.

Access:

1. Select "System Config" > "Remote Access" > "Remote Connections".
2. Select "Active".

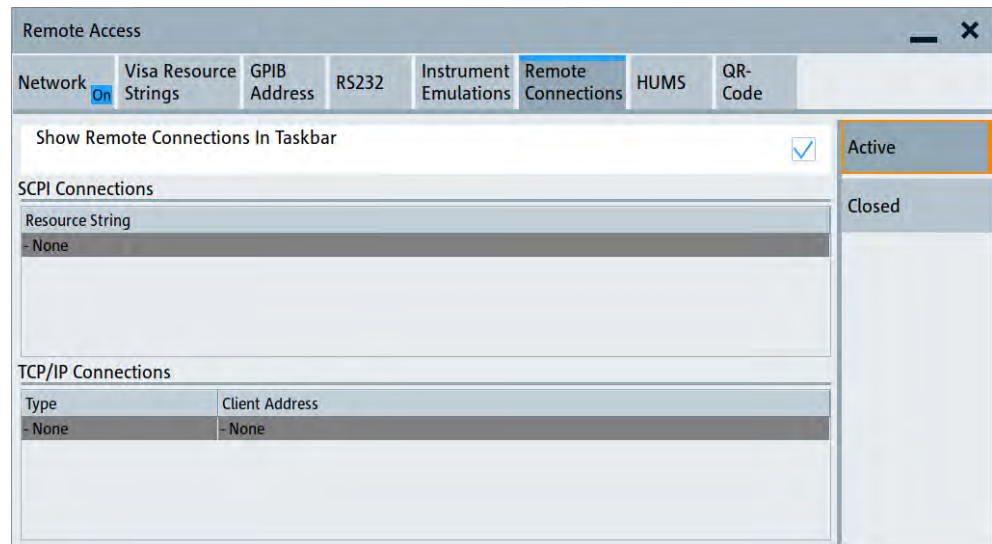

The "Active" tab shows the currently active remote connections, and you can enable the display of the active connections in the task bar.

**Settings:**

Show Remote Connections in Taskbar.....	839
SCPI Connections.....	839
TCP/IP Connections.....	839

**Show Remote Connections in Taskbar**

Displays the currently active connections in the taskbar.

**SCPI Connections**

Displays the VISA resources strings of the remote connections currently controlling the instrument via the LAN interface.

Remote command:

n.a.

**TCP/IP Connections**

Displays the types and client addresses of the remote connections currently controlling the instrument via the LAN interface.

Remote command:

n.a.

**13.5.7 Closed remote connection settings**

This dialog displays a history list of the connections that have accessed the instrument before.

Access:

1. Select "System Config" > "Remote Access" > "Remote Connections".
2. Select "Closed".

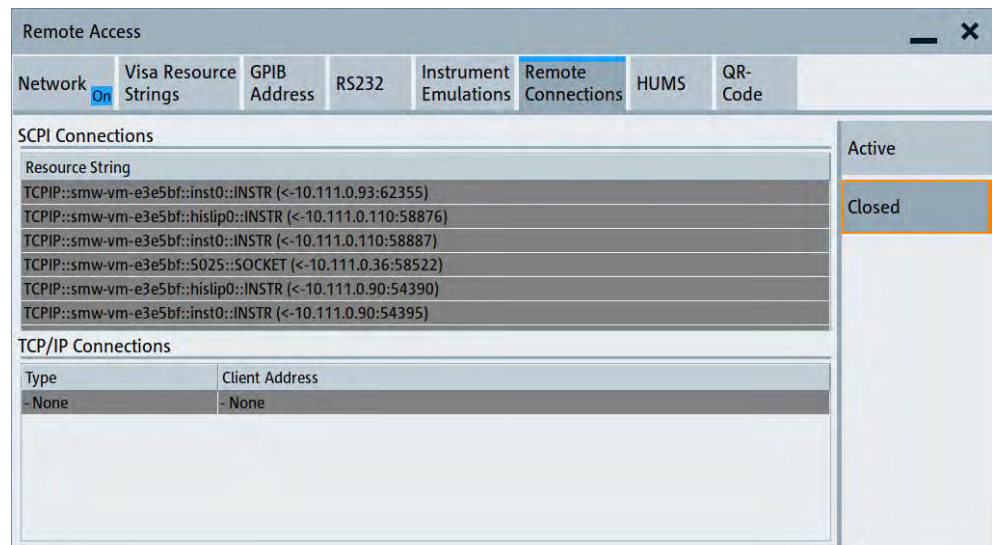

The "Closed" tab shows the currently active remote connections, and you can enable the display of the active connections in the task bar.

#### Settings:

SCPI Connections.....	840
TCP/IP Connections.....	840

#### SCPI Connections

Lists the VISA resource strings of the last remote connections that have accessed the instrument via the LAN interface before.

Remote command:  
n.a.

#### TCP/IP Connections

Lists the types and client addresses of the last remote connections that had accessed the instrument via the LAN interface before.

Remote command:  
n.a.

### 13.5.8 HUMS settings

Requires R&S SMW-K980.

#### About health and utilization monitoring system (HUMS)

The R&S SMW200A comes with a health and utilization monitoring system (HUMS) providing information about the R&S SMW200A. Aim is to increase the overall utilization, to avoid downtime and to increase the overall security level of a fleet of instruments.

HUMS provides, for example, information about:

- Instrument identification, hardware components, software packages, licenses
- Usage of remote control, usage via keyboard / mouse, usage of test applications
- Hardware utilization and status, including S.M.A.R.T. data of the system drive
- User-defined static information, for example, an inventory code

#### Interfaces and protocols

The HUMS installation on the R&S SMW200A includes an SNMP agent and a REST service with HTTP endpoints. So you can access the health and usage information via LAN, using the SNMP protocol or the REST protocol. Accessing the data does not interfere with remote control via SCPI commands or with measurement execution.

Reference information for both protocols is available on the R&S SMW200A at the address <http://<instrument>/api/hums/v1/documents?name=<interface>>.

For <instrument>, enter the hostname (e.g. *SMW200A-102030*) or the IP address (e.g. *10.121.0.34*) of your instrument, as for access to the GUI.



For *<interface> = snmp*, you get a `.zip` file containing the MIB files for SNMP. For *<interface> = rest*, you get a web page with the OpenAPI specification of the REST API.

Address example: `http://SMW200A-102030/api/hums/v1/documents?name=snmp`.

The following table lists the REST endpoints and the SNMP MIB file names.

REST endpoint /api/hums/v1/...	SNMP MIB	Description	Typical data
documents	---	developer information	SNMP MIB files, swagger specification of HUMS REST endpoints
greetings	RS-GREETINGS-MIB	identity information	manufacturer, model, serial number, version
equipment/bios	RS-BIOS-INFO-MIB	BIOS information	BIOS manufacturer, version and release date
date-time	RS-TIME-DATE-MIB	time and date information	UTC and local time, timezone, dst (daylight savings time)
device-history	RS-DEVICE-HISTORY-MIB	history events	instrument-specific event information and notifications
device-tags	RS-DEVICE-TAGS-MIB	customer information	user-definable key information, associated with the instrument, e.g. asset number, owner, location
equipment	RS-EQUIPMENT-MIB	footprint information	hardware and software configuration, licenses
hums-info	RS-HUMS-INFO-MIB	basic information on the HUMS service	HUMS version, counter of SNMP and REST requests, amount of collected data, HUMS database size
storage	RS-STORAGE-MIB	S.M.A.R.T. data of drive	system drive temperature, drive health
system-info	RS-SYSTEM-INFO-MIB	a system overview	OS and BIOS version, IP address, locale
system-status	RS-SYSTEM-STATUS-MIB	system status information	global system status, static notifications
utilization	RS-UTILIZATION-MIB	utilization information	instrument activity, e.g., power on time, RF on time, option utilization, remote interface traffic

For detailed information about HUMS and its applications, refer to:

- The R&S®HUMS Health and Utilization Monitoring Service user manual, available on the Rohde & Schwarz website.
- The application note [GFM336](#)

Access:

- ▶ Select "System Config" > "Remote Access" > "HUMS".

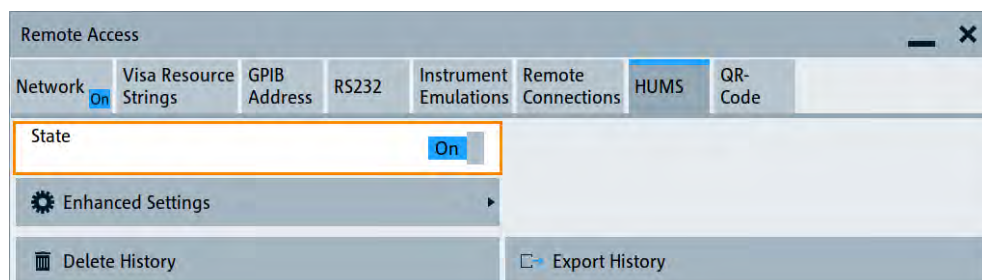

The dialog provides settings to configure the health and utilization monitoring system (HUMS) of the R&S SMW200A.

The remote commands required to define these settings are described in [Section 14.11, "HUMS remote control commands"](#), on page 926.

### Settings:

<a href="#">State</a> .....	842
<a href="#">Enhanced Settings</a> .....	842
<a href="#">Delete History</a> .....	842
<a href="#">Export History</a> .....	842

#### State

Activates HUMS.

Data is only recorded if HUMS is enabled. If disabled, already recorded data can still be retrieved.

The setting is reset by a factory preset to "off".

Remote command:

`DIAGnostic:HUMS:STATe` on page 928

#### Enhanced Settings

Opens a dialog for configuring enhanced protocol settings, see [Section 13.5.9, "HUMS enhanced settings"](#), on page 843.

Access is only available, when HUMS is enabled, see [State](#).

#### Delete History

Deletes all information from the HUMS service including the device history.

**Note:** Regarding the instrument security, the sanitization procedure also deletes the history of the HUMS service, see [Section 12.7.1, "Disk & memory security settings"](#), on page 795.

Remote command:

`DIAGnostic:HUMS:DEVIce:HISTory:DELeTe:ALL` on page 927

#### Export History

Triggers an export of the logged data of the HUMS service into a \*.zip file.

A standard file dialog opens, to save the log file. By default, the file is saved to the directory `/var/user/`.

Remote command:

[DIAGnostic:HUMS:DEvice:HISTory?](#) on page 927

[DIAGnostic:HUMS:SAVE](#) on page 928

### 13.5.9 HUMS enhanced settings

Access:

1. Select "System Config > Remote Access > HUMS".
2. Select "State > ON".
3. Select "Enhanced Settings".

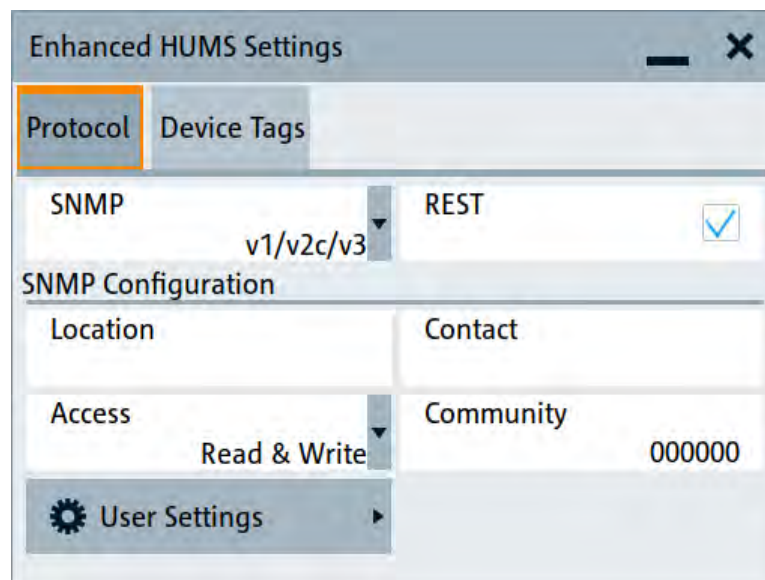

The dialog provides enhanced settings for configuring protocol settings and device tags.

The remote commands required to define these settings are described in [Section 14.11, "HUMS remote control commands"](#), on page 926.

- [Protocol settings](#).....843
- [SNMP user settings](#)..... 845
- [Device tag settings](#).....849

#### 13.5.9.1 Protocol settings

The "Protocol" tab of the "Enhanced HUMS Settings" dialog provides protocol settings for SNMP or REST protocol.

**Access:**

1. Select "System Config > Remote Access > HUMS".
2. Select "State > ON".
3. Select "Enhanced Settings".
4. Select "Protocol".

The dialog provides enhanced settings for configuring protocol settings and device tags.

**Settings:**

SNMP.....	844
REST.....	844
SNMP Configuration.....	844
L Location.....	844
L Contact.....	845
L Access.....	845
L Community.....	845
User Settings.....	845

**SNMP**

Enables the SNMP agent and selects the supported SNMP version to communicate with the service.

The setting is reset by a factory preset to "v1/v2c".

"Off"	The SNMP agent is disabled.
"v1/v2c"	Selects SNMP version 2, which also enables version v1.
"v1/v2c/v3"	Selects all SNMP version v1, v2c and v3.
"v3"	Selects SNMP version v3.

Remote command:

[SYSTem:COMMunicate:SNMP:VERSion](#) on page 933

**REST**

Enables the REST API protocol.

The setting is reset by a factory preset to "On".

Remote command:

[SYSTem:COMMunicate:REST:ENABLE](#) on page 930

**SNMP Configuration**

For SNMPv1 and SNMPv2c authentication, you can define "Access" and "Community". For SNMPv3 authentication, you can define "User" profiles.

**Location ← SNMP Configuration**

Defines the SNMP location information. This information complies with the server's physical location and is used for identification of the SNMP server. By default, this input field is empty.

Remote command:

[SYSTem:COMMunicate:SNMP:LOCation](#) on page 931

#### **Contact ← SNMP Configuration**

Sets the SNMP contact information. This information complies with the person who manages the SNMP server and is used for identification of the SNMP server. By default, this input field is empty.

Remote command:

[SYSTem:COMMunicate:SNMP:CONtact](#) on page 931

#### **Access ← SNMP Configuration**

Defines the access type for SNMP community string.

For read access, you can use "Read" or "Read & Write". For write access, use "Read & Write".

The setting is reset by a factory preset to "Read & Write".

Remote command:

[SYSTem:COMMunicate:SNMP:COMMunity:RO](#) on page 930

[SYSTem:COMMunicate:SNMP:COMMunity:RW](#) on page 930

#### **Community ← SNMP Configuration**

Defines the SNMP community string that can be a group of instruments with SNMP version v2 support.

The setting is reset by a factory preset to the "<serial number>" of the instrument.

#### **User Settings**

Accesses the "Configure SNMP Users for HUMS" dialog.

### **13.5.9.2 SNMP user settings**

For SNMPv3 authentication, you can define user profiles.

Access:

1. Select "System Config > Remote Access > HUMS".
2. Select "State > ON".
3. Select "Enhanced Settings".
4. In the protocol tab, select SNMP communication with SNMPv3, e.g. "SNMP > v1/v2c/v3".

5. Select "User Settings".

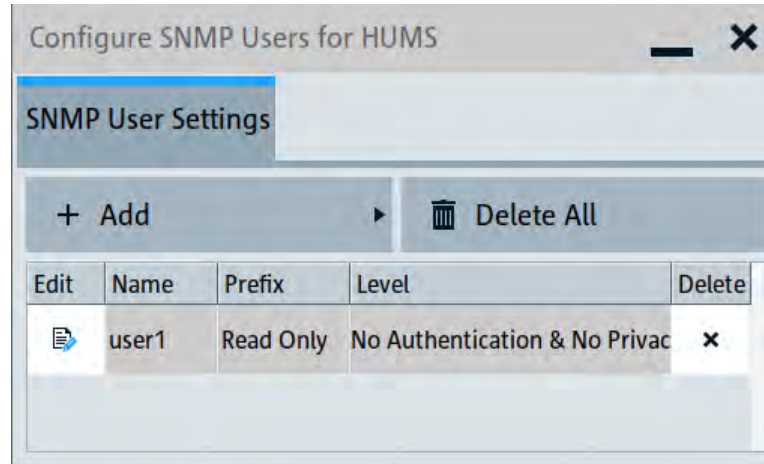

The "Configure SNMP User for HUMS" dialog provides an overview of all defined SNMP users and their profiles. With the "Add" and "Delete All" controls, you can add or remove users.

#### Settings:

Add.....	846
Delete All.....	846
User table.....	847
L Edit.....	847
L Name.....	848
L Prefix.....	848
L Level.....	848
L Delete.....	848
Add SNMP User for HUMS.....	848
L SNMP User Name.....	848
L SNMP User Prefix.....	848
L SNMP User Level.....	849
L SNMP User Public Passphrase.....	849
L SNMP User Encrypted Passphrase.....	849
L Add / Update.....	849

#### Add

Accesses the "Add SNMP User for HUMS" dialog.

In this dialog, you can define a user and its profile, see ["Add SNMP User for HUMS"](#) on page 848.

#### Delete All

Removes all users from the list.

Remote command:

[SYSTem:COMMunicate:SNMP:USM:USER:DELeTe:ALL](#) on page 932

**User table**

Lists all defined SNMP users.

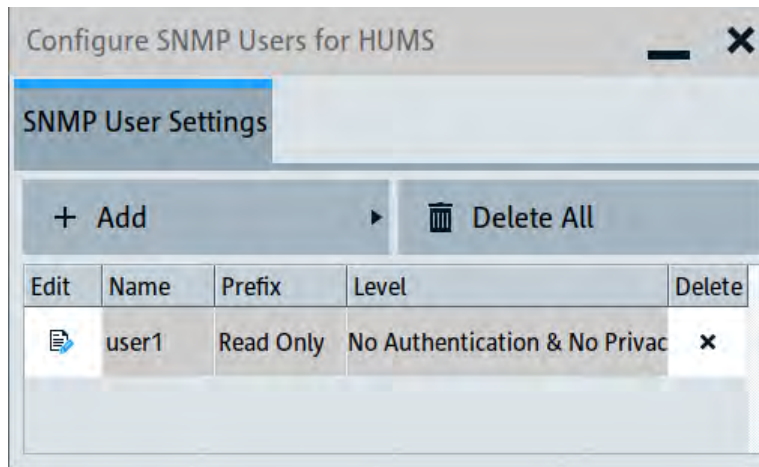

Edit	Name	Prefix	Level	Delete
	user1	Read Only	No Authentication & No Privac	

The table informs on the user name and its specified user profile.

Remote command:

[SYSTem:COMMunicate:SNMP:USM:USER:ALL?](#) on page 932

**Edit ← User table**

Accesses the "Edit SNMP Users for HUMS" dialog, where you can modify an already defined user profile.

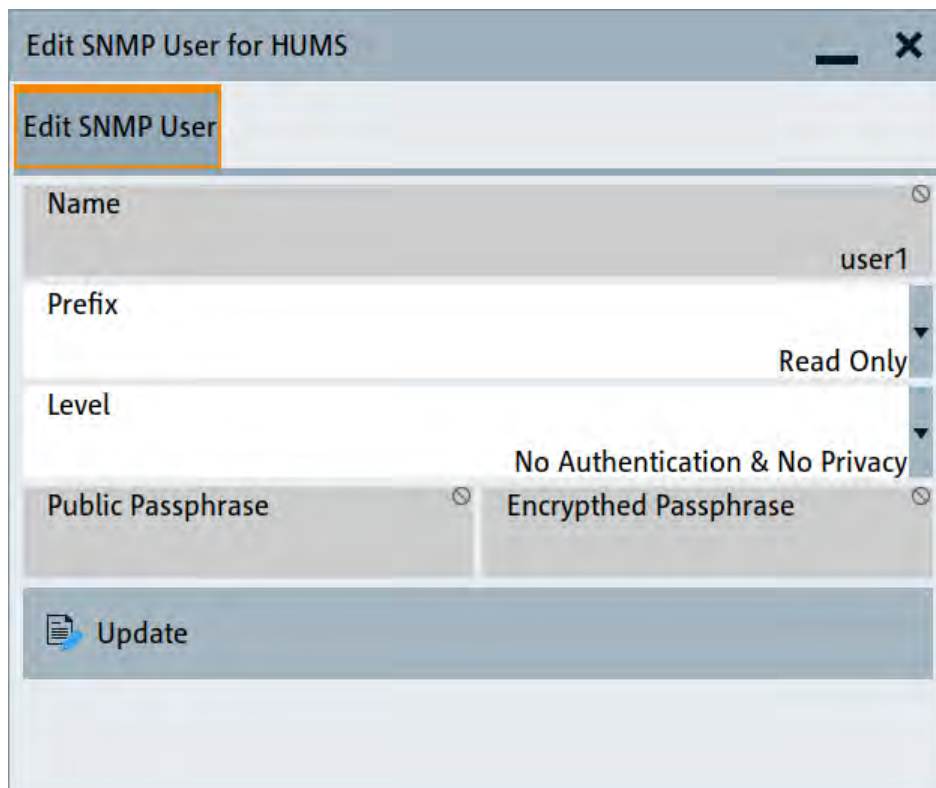

For description on the entry fields, see [Add SNMP User for HUMS](#).

**Name ← User table**

Shows the user name of the user who should have specific user rights.

**Prefix ← User table**

Shows the access right of the selected user.

**Level ← User table**

Shows the security level of the selected user.

**Delete ← User table**

Removes the selected user from the list.

Remote command:

[SYSTem:COMMunicate:SNMP:USM:USER:DELeTe](#) on page 932

**Add SNMP User for HUMS**

Configuration dialog for defining SNMP users and their profiles.

Remote command:

[SYSTem:COMMunicate:SNMP:USM:USER](#) on page 931

**SNMP User Name ← Add SNMP User for HUMS**

Defines the name of the user for assigning specific user rights. Entering a user name is mandatory.

**SNMP User Prefix ← Add SNMP User for HUMS**

Defines the access right for a user.

"Read Only"      Allows the user to only read information.



"Read & Write" Allows the user to read and modify information.

#### **SNMP User Level ← Add SNMP User for HUMS**

Defines the security level of the SNMP user. Depending on the security level, the service requests user name and passphrases for authentication and encryption.

"No Authentication & No Privacy"

Low security level. Using this level, the service queries the user name only. Password authentication and password for encrypted data transfer is not requested.

See "[SNMP User Public Passphrase](#)" on page 849 and "[SNMP User Encrypted Passphrase](#)" on page 849 for data transfer is not requested.

"Authentication & No Privacy"

Medium security level: Requests the user name and password authentication, but no data transfer encryption.

"Authentication & Privacy"

High security level: Requests the user name, and both, the password authentication and the password for data transfer encryption.

#### **SNMP User Public Passphrase ← Add SNMP User for HUMS**

Defines the password for authentication. The password must have of 8 to 12 characters with any combination of ASCII characters.

#### **SNMP User Encrypted Passphrase ← Add SNMP User for HUMS**

Defines the password for encryption. This password must have at least 8 characters with any combination of ASCII characters. When encryption is defined, the R&S SMW200A supports the DES (directed enhanced services) protocol.

#### **Add / Update ← Add SNMP User for HUMS**

Assigns the defined user with its profile to the list.

If you change an already defined user profile, the instrument provides the "Update" button to apply the modifications.

### **13.5.9.3 Device tag settings**

The "Device Tags" tab of the "Enhanced HUMS Settings" dialogs displays the defined device tags. You can also add or delete device tags here.

A device tag is a label to assign to your instrument. You can create any device tag for your instrument and define it by a specific key and value.

Access:

1. Select "System Config > Remote Access > HUMS".
2. Select "State > ON".
3. Select "Enhanced Settings".

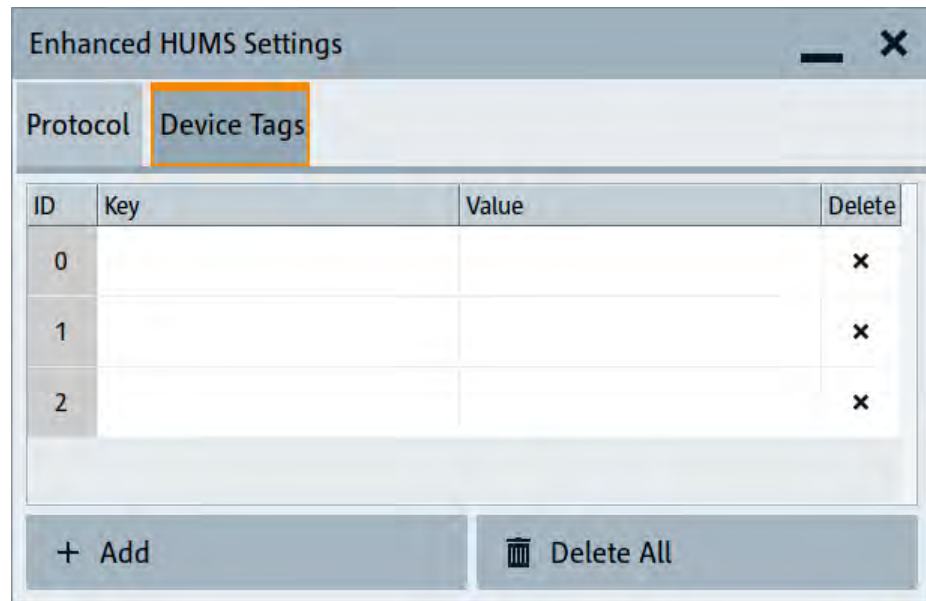

Configures device tags for tagging user-defined information of the instrument in a table. You can define up to 32 device tags, e.g., for HUMS history evaluation.

To add a device tag, define "Key" and "Value" of the device tag in the table. Click "Add" to add all device tags of the table to the HUMS history.

#### Settings:

ID.....	850
Key.....	850
Value.....	850
Delete.....	850
Add.....	851
Delete All.....	851

#### ID

Identification count of a device tag entry.

#### Key

Sets the identification key of a device tag.

Remote command:

[DIAGnostic:HUMS:TAGS\[:VALue\]](#) on page 929

#### Value

Sets the value of the identification key of a device tag.

Remote command:

[DIAGnostic:HUMS:TAGS\[:VALue\]](#) on page 929

#### Delete

Deletes the selected device tag from the HUMS history.

Remote command:

[DIAGnostic:HUMS:TAGS:DELeTe](#) on page 929

**Add**

Adds a new device tag to the HUMS service.

Remote command:

[DIAGnostic:HUMS:TAGS\[:VALue\]](#) on page 929

[DIAGnostic:HUMS:TAGS:ALL?](#) on page 928

**Delete All**

Removes all device tags from the HUMS history.

Remote command:

[DIAGnostic:HUMS:TAGS:DELeTe:ALL](#) on page 929

### 13.5.10 QR code

Access:

- ▶ Select "System Config" > "Remote Access" > "QR Code".



The "QR Code" dialog shows the current instrument address (IP address) in quick response (QR) format.

This functionality provides fast access to the instrument via VNC with, for example, a smartphone or a tablet.

See [Section 13.10.2, "Using a smart device"](#), on page 888

## 13.6 LXI status settings

On the R&S SMW200A, an LXI functionality is already installed and enabled. Thus, you can access the instrument using any web browser.

See [Section 13.7, "LXI browser settings"](#), on page 853.

Access:

- ▶ Select "System Config > Setup > Remote Access > LXI Status".

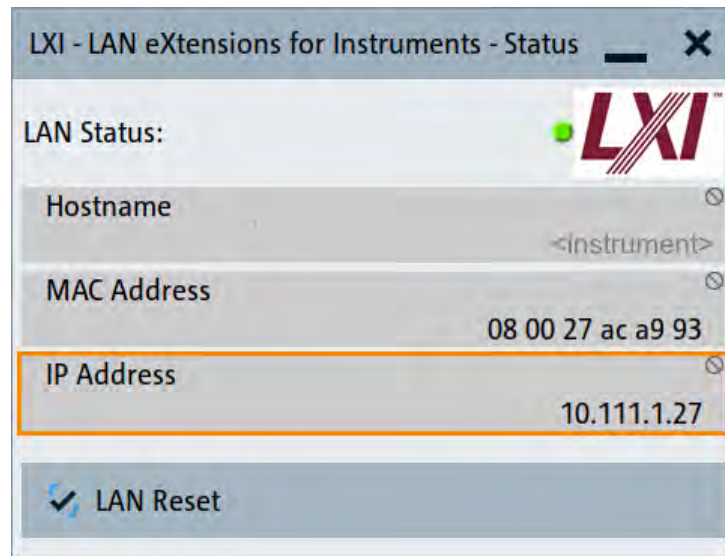

The LXI "LAN Status" dialog shows the parameters of the LAN connection.

Alternatively, you can change the LAN settings using the LXI web browser interface, see [Section 13.7.1, "LAN configuration"](#), on page 855.

#### Settings:

<a href="#">LAN Status</a> .....	852
<a href="#">Hostname / MAC Address / IP Address</a> .....	852
<a href="#">LAN Reset</a> .....	852

#### LAN Status

The LED indicates the LXI status.

"green"	Normal operation
"green (flashing)"	Device identification
"red"	LAN fault

#### Hostname / MAC Address / IP Address

See "[Hostname](#)" on page 831.

#### LAN Reset

Initiates the network configuration reset mechanism for the instrument and resets the hostname, MAC address, and IP address.

According to the LXI standard, a LAN reset must set the following network parameters to a default state:

Parameter	Value
TCP/IP mode	DHCP + Auto IP address
Dynamic DNS	Enabled

Parameter	Value
ICMP ping	Enabled
Password for LAN configuration	LxiWebIfc

The LAN reset also resets the following parameters for the R&S SMW200A:

Parameter	
Hostname	Instrument-specific hostname
Description	vector signal generator
Negotiation	Auto detect
VXI-11 discovery	Enabled

## 13.7 LXI browser settings

Accessing the R&S SMW200A over the LXI browser interface, you can perform the following tasks:

- Modifying network configurations, see [Section 13.7.1, "LAN configuration"](#), on page 855.
- Accessing the instrument remotely
- Analyzing SCPI remote diagnostics
- Monitoring the use and status of the instrument  
This service requires option R&S SMW-K980 "Health and utilization monitoring service (HUMS)".

Access:

- In the address field of the browser, enter the URL address, composed of the instrument's IP address or host name, for example *http://10.113.1.151*.  
**Note:** Do not add the missing zeros in the IP address, while opening the instrument homepage.

The instrument homepage (welcome page) opens.



The navigation pane of the browser interface contains the following elements:

- "LXI"
  - "Home" opens the instrument homepage. The homepage displays the device information required by the LXI standard, including the VISA resource string in read-only format.
  - "Device Indicator" activates or deactivates the LXI status indication. When activated, the LXI LED flashes. A green LXI status symbol indicates that a LAN connection has been established; a red symbol indicates that no LAN cable is connected.
  - "Lan Configuration" allows you to configure LAN parameters and to initiate a ping, see [Section 13.7.1.3, "Ping client"](#), on page 857.
  - "Status" displays information about the LXI status of the instrument.
  - "Utilities" provides access to the LXI event logging functionality required by the LXI standard.
- "Instrument Control"
  - "Web Control" provides remote access to the instrument. See ["To start remote control with the LXI browser"](#) on page 864.
- "Diagnostics"
  - "SCPI Remote Trace" records messages exchanged via the remote control interface, see [Section 13.7.2, "SCPI remote trace"](#), on page 857.
  - "Health & Utilization" (option: R&S SMW-K980) enables you to monitor the use and status of an instrument, see [Section 13.7.3, "Health and utilization"](#), on page 859.
- "Datasheet"
  - Provides the Datasheet with the specification data of the instrument at the time of delivery, see [Section 13.7.4, "Datasheet"](#), on page 859.
- "Help"
  - "Glossary" explains terms related to the LXI standard.
  - [www.rohde-schwarz.com](http://www.rohde-schwarz.com) opens the Rohde & Schwarz homepage.

## 13.7.1 LAN configuration

The "LAN Configuration" web page displays all mandatory LAN parameters and allows their modification.

It comprises the following navigation entries.

- [IP configuration](#)..... 855
- [Advanced config](#).....856
- [Ping client](#).....857

### 13.7.1.1 IP configuration

The "IP configuration" web page displays all mandatory LAN parameters and allows their modification.

The screenshot shows the LXI LAN Parameters configuration page. The left sidebar contains navigation options: Home, Lan Configuration (with sub-options: IP Configuration, Advanced Config, Ping Client), Status, Utilities, Instrument Control, Web Control, Diagnostics (with sub-options: SCPI Remote Trace, Health & Utilization), Datasheet (with sub-options: Production Version), and Help (with sub-options: Glossary, www.rohde-schwarz.com). The main content area is titled 'LAN Parameters' and contains the following fields:

- Hostname: <host name>
- DNS Hostname(s): <host name.xoc.net>
- Domain: rsint.net
- Description: <instrument>
- IP Address Mode: DHCP + Auto IP Address
- IP Address: 10.102.189.51
- Subnet Mask: 255.255.252.0
- Default Gateway: 10.102.188.1
- Obtain DNS Server Address automatically:
- DNS Server(s): 10.0.2.166
- Register Device at DNS Server dynamically:
- HiSLIP Port: 4880

A 'Submit' button is located below the HiSLIP Port field. A note on the right side of the form states: 'Attention! Changing the hostname reboots the device!'. At the bottom, there is a password field with the label '(Password required!)'. The status bar at the bottom indicates 'No error' and includes the copyright notice '© 2022 ROHDE&SCHWARZ. All rights reserved.'

The "IP Address Mode" selects a configuration mode for the IP address of the instrument. With static configuration, the entered IP address, subnet mask, and default gateway are used. With dynamic configuration, DHCP or dynamic link local addressing (automatic IP) is used to obtain the instrument IP address.



#### Changing the LAN configuration

This function is password-protected. Unlock the protection level 1 to access it.

**Note:** We recommend that you change the default password before connecting the instrument to a network.

How to:

- ["To change the user password of the instrument"](#) on page 807.
- ["To change the security password"](#) on page 807.

See [Section 12.7.5, "Password management"](#), on page 804.

### 13.7.1.2 Advanced config

The "Advanced Config" web page provides LAN settings that are not declared mandatory by the LXI standard.

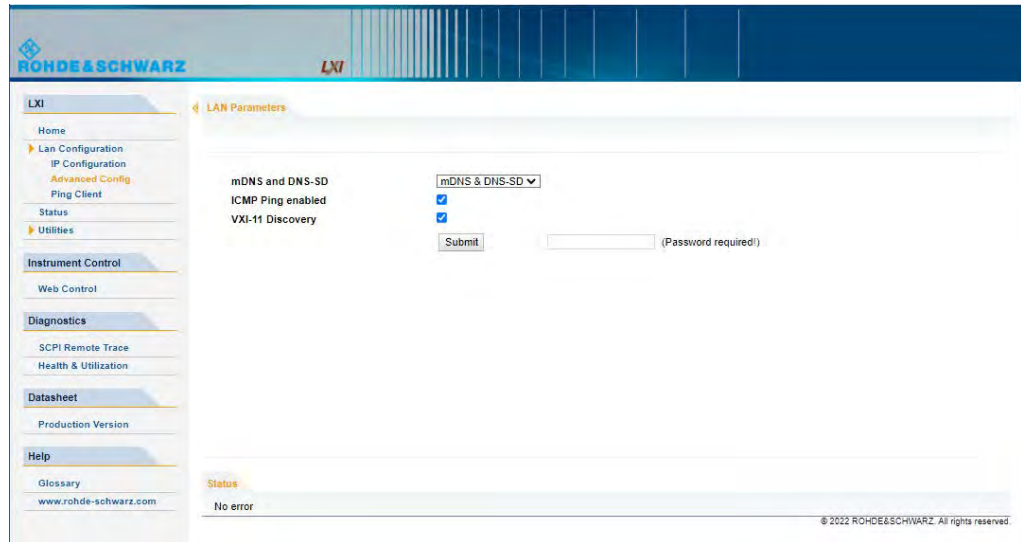

The following advanced parameters are available:

- "mDNS and DNS-SD": The additional protocols "multicast DNS" and "DNS service discovery" are used for device communication in zero configuration networks, working without DNS and DHCP.
- "ICMP Ping": Must be enabled to use the ping utility. If you disable this setting, the instrument does not answer ping requests. The setting does not affect the LXI ping client. You can ping other hosts from the instrument, even if the setting is disabled.
- "VXI-11 Discovery": Must be enabled to detect the instrument in the LAN. If you disable this setting, the instrument cannot be detected by the VXI-11 discovery protocol mechanism. The setting does not affect other detection mechanisms. Setting up a VXI-11 connection via the IP address or the host name is independent of this setting.



#### Changing the LAN configuration

This function is password-protected. Unlock the protection level 1 to access it.

**Note:** We recommend that you change the default password before connecting the instrument to a network.

How to:

- ["To change the user password of the instrument"](#) on page 807.
- ["To change the security password"](#) on page 807.

See [Section 12.7.5, "Password management"](#), on page 804.



### 13.7.1.3 Ping client

The "Ping Client" page provides the ping utility to verify the connection between the LXI-compliant instrument and another device.

The ping is initiated from the instrument. Using the `ICMP` echo request and echo reply packets, this function checks whether the communication with a device via LAN is working. Ping is useful for the diagnosis of IP network or router failures.

To initiate a ping at the instrument:

1. On the "Ping Client" page, enter the IP address of the host in the "Destination Address" field (for example 10.113.1.151).
2. Select "Submit".

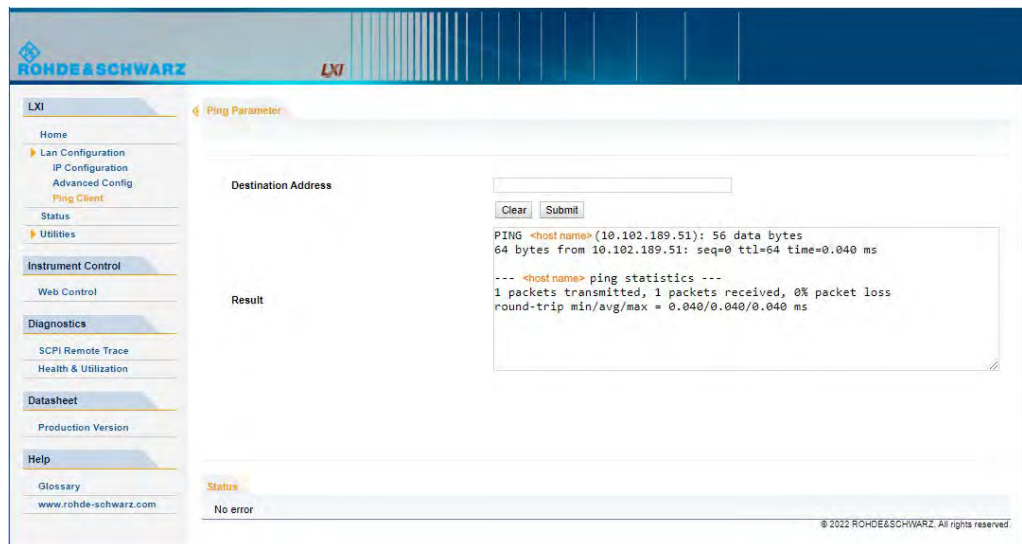

### 13.7.2 SCPI remote trace

The remote trace functionality allows you to trace input and output strings at the remote control interface of the R&S SMW200A.

See ["To activate SCPI remote trace"](#) on page 864

A recorded trace (message log) can be evaluated directly in the dialog. Use the highlighting and navigation functions provided by the lower toolbar to locate error messages and messages containing arbitrary search strings. You can also export the message log to a `*.CSV` file and evaluate the file using a suitable program.

To trace and display messages, switch on "logging" and "live mode" in the toolbar.

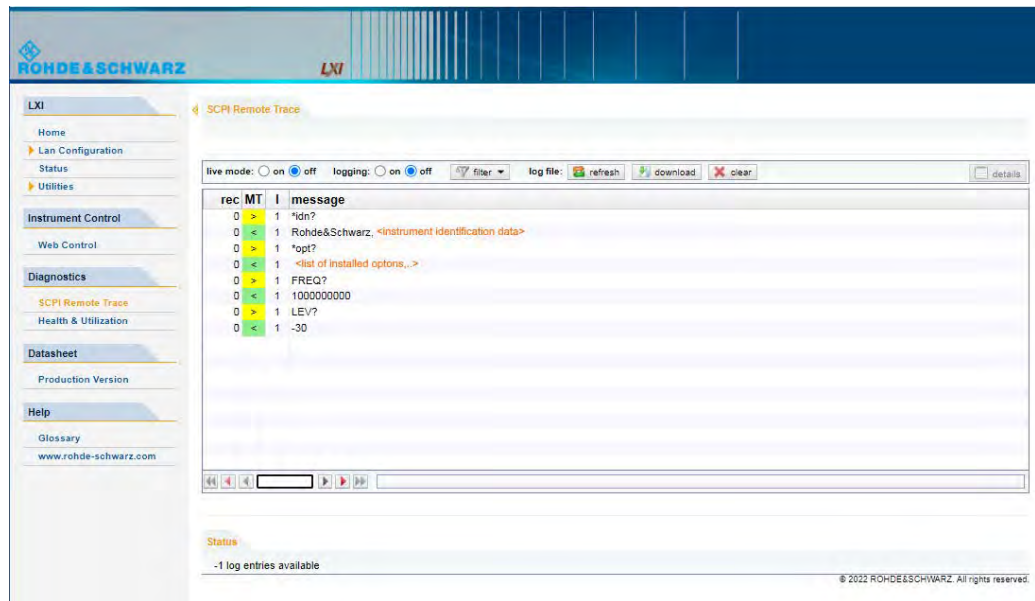

## Toolbars

The toolbar at the top of the dialog provides basic settings and functions.

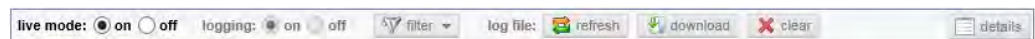

- "Live mode" / "logging": If logging is switched on, messages are traced. They are stored in an internal database and can be displayed upon request, using the refresh button (live mode off) or they can be displayed automatically (live mode on).
- "Filter": applies a filter to columns and/or rows when working (live mode off)
- "Refresh": reads the message log from the internal database and displays it
- "Download": stores the SCPI trace log to a \* .CSV file
- "Clear": deletes all message log entries in the database and at the screen
- "Details": displays details of the selected message, for example an SCPI command in hex format (also possible by double-clicking a message)

## Columns

The following columns are available if no column filter is applied:

- "Rec": record number of the message within the message log
- "MT": indicates the type of the message. Possible values and related message contents are:
  - > = incoming command
  - < = outgoing response to a query
  - E = error message, highlighted by red color
  - T = execution time, i.e. time required by the instrument to process the command internally.
- I: number of the subinstrument

- "message": indicates the type of the message. Possible values and related message contents are:
  - > = incoming command
  - < = outgoing response to a query
  - E = error message, denoted in red
  - T = execution time, i.e. time required by the instrument to process the command internally

### 13.7.3 Health and utilization

Option: R&S SMW-K980

The health and utilization monitoring service allows you to monitor the usage and status of the instrument, its options, including S.M.A.R.T. data of the system drive. You can retrieve information on remote accesses over SCPI commands, web browsers or protocols, as for example SNMP or REST.

For detailed information on R&S HUMS, see the following documents, available on the Rohde & Schwarz website:

- User manual "R&S Health and Utilization Monitoring Service" , describing how to access and use the service.
- Application note [GFM336](#), providing information on the SNMP and REST API, including a list of all SNMP variables and REST endpoints.

### 13.7.4 Datasheet

The datasheet functionality allows you to retrieve the specification data of the instrument at the time of delivery.

The document contains all specified value ranges and information of the datasheet, for example important as reference values for recalibration.

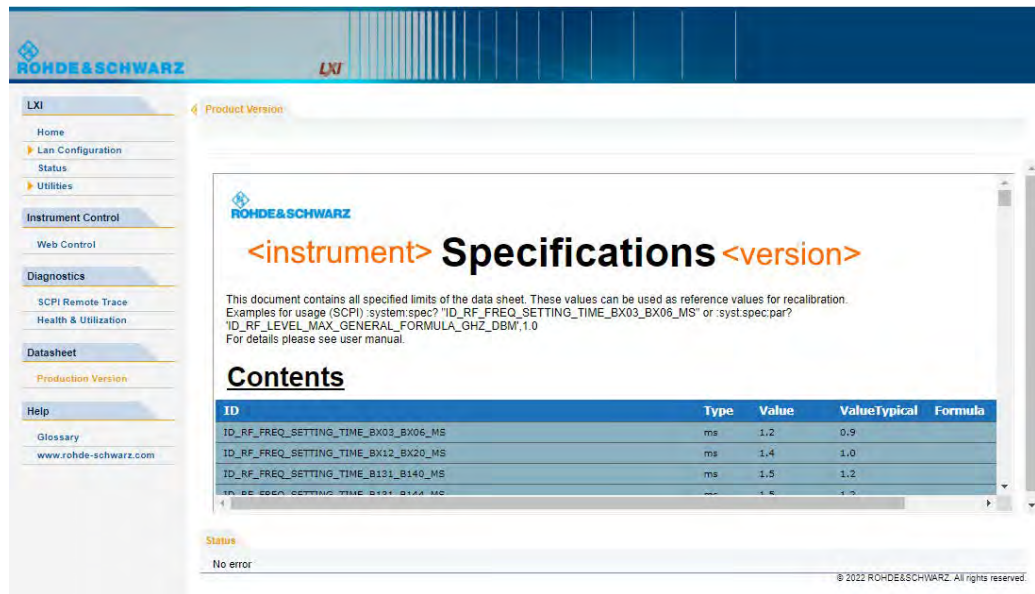

For more information, refer to the specifications document.

## 13.8 Setting up remote control

When you switch on the R&S SMW200A, it is always in manual operation state ("local" state). You can operate the instrument over the touchscreen, the front panel and an external keyboard and/or mouse.

### Prerequisites

For remote control, make sure that you have fulfilled the following prerequisites:

- The instrument and the controller PC are connected for remote control. See [Section 3.1.7, "Connecting to LAN"](#), on page 32.
- The instrument and the controller are switched on.
- The LAN interface and SCPI over LAN are enabled. See [Section 12.7.4, "Configuring LAN services"](#), on page 800.
- A remote control program is running on the controller.



If security is a concern, see:

- Document Instrument Security Procedures.
- [Section 12.7.6, "Preventing unauthorized access"](#), on page 806.

The following sections describe how to start remote control over the available interface protocols.

- [Configuring remote access](#)..... 861
- [Starting remote control with LXI](#)..... 864
- [Starting remote control with VXI-11](#)..... 865

- [Starting remote control with socket communication](#).....870
- [Starting remote control over GPIB](#)..... 871
- [Starting remote control over USB](#)..... 872
- [Stopping remote control](#).....872

### 13.8.1 Configuring remote access

Depending on the network capacities, the TCP/IP address information for the instrument can be obtained in different ways.

- If the network supports dynamic TCP/IP configuration using the [DHCP](#) protocol, this service assigns all address information automatically (default setting).
- If the network does not support DHCP or if there is no server available, the instrument tries to obtain the IP address using the [Zeroconf](#)(Avahi) protocol. This protocol enables the instrument to self-configure an IP address and subnet mask. Zeroconf (Avahi) IP addresses start with the number blocks 169.254.\*.\*, with the subnet mask of 255.255.

The automatic address configuration establishes the physical connection to the LAN without any additional configuration.



An IP address that is assigned with the Zeroconf protocol although the network requires an IP address assigned from the DHCP server can cause network connection failures.

See [Section 15.5, "Resolving network connection failures"](#), on page 1345.

If both services fail to connect, you must set the address information manually.

See also ["To assign the instrument address manually"](#) on page 862.

#### To find the VISA resource string

- ▶ Select "System Config > Remote Access > VISA Resource Strings".

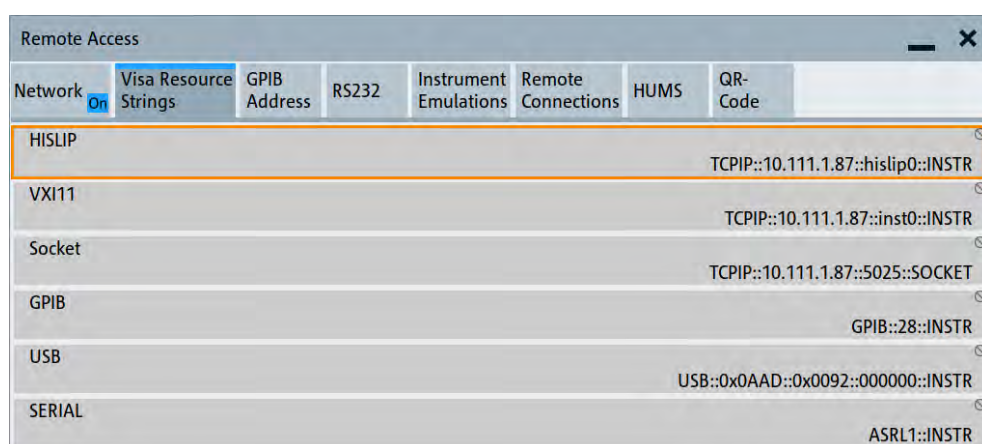

The dialog shows the VISA resource strings that enable you to access the instrument for remote control.

**Note:** Using the RS232 serial interface via USB requires the USB serial adapter R&S TS-USB1.

### To assign the instrument address manually

It is assumed that you have connected the instrument in the LAN.

1. Obtain the instrument address information for the R&S SMW200A and the IP address for the local default gateway from your network administrator. If necessary, also obtain the name of your DNS domain and the IP addresses of the DNS server on your network.  
Obtain the IP address and subnet mask for the R&S SMW200A and the IP address for the local default gateway from your network administrator. If necessary, also obtain the name of your DNS domain and the IP addresses of the DNS server on your network.
2. On the instrument, select "System Config > Remote Access > Network".
3. Select "Address Mode > Static".
4. Select the "IP Address".
5. Enter the IP address, for example *192.168.0.1*.  
The IP address consists of four number blocks separated by dots. Each block contains 3 numbers in maximum.
6. Select the "Subnet Mask" and enter the subnet mask, for example *255.255.255.0*.  
**Note:** The subnet mask must be the same for both, the R&S SMW200A and the host interface, the instrument is connected to.
7. Enter the "Default Gateway", "DNS Suffix", and "DNS Server" if necessary.

### Using the hostname

In a LAN that uses a [DNS](#) server, each computer or instrument connected in the LAN can be addressed with an unambiguous [Hostname](#) (also referred to as computer name) instead of the IP address. The DNS server translates the hostname to the IP address.



Using the hostname is useful in networks with dynamic TCP/IP and DHCP protocol services, that assign the address information automatically. Thus, it can be that the services assign a new IP address each time the instruments restarts, but they do not change the hostname.



### Changes in hostname syntax

From FW version 3.20.200.xxx and later, the hostname syntax is changed.

- Current hostname syntax: `<INST>-<Serial Number>`
- Former syntax: `rs<inst><Serial Number>`

Note, that a "Factory Preset" resets the hostname. Depending on the installed firmware version, the hostname of your instrument can change compared to the past.

Each instrument is delivered with an assigned hostname, that remains constant as long as it is not explicitly changed.

This function is password-protected. Unlock the protection level 1 to access it.

The default *hostname* name follows the syntax <INST>-<Serial Number>, where:

- <INST> is the short name of your instrument, as stated on the front panel.
  - <Serial Number> is the individual serial number of the instrument.
- You can find the serial number at the rear panel of instrument. It is the third part of the device ID printed on the barcode sticker.



### To query and change the hostname

1. Select "System Config > Remote Access > Network".  
Section "Instrument Name" displays the assigned "Hostname".  
**Note:** This function is password-protected. Unlock the protection level 1 to access it.
2. Select "System Config > Setup > Security > Protection".
3. Enable the "Protection Level 1".  
The default protection level 1 password is 123456.  
The parameter "Hostname" in the "Network" tab is now enabled for configuration.
4. Change the "Hostname".

### Configuring LAN access and services

By default, the LAN interface and the supported LAN interface services are enabled. For security reasons, for example to protect the instrument against unauthorized access, you can block either the LAN services individually, or the access over LAN in general.

For information on how you configure the remote access individually, see the following sections:

- [Section 12.7.4, "Configuring LAN services"](#), on page 800
- ["To disable LAN access in general"](#) on page 807
- ["To disable LAN services individually"](#) on page 808
- ["To enable SMB version 1.0/2.0 client and server"](#) on page 809

### Configuring access over GPIB

To control the instrument remotely over the GPIB bus, it must be addressed using the GPIB address. The remote control address is factory-set to 28, but it can be changed if it does not fit in the network environment. For remote control, addresses 0 through 30 are allowed. The GPIB address is maintained after a reset of the instrument settings.

**To change the GPIB address**

1. Select "System Config" > "Remote Access" > "GPIB Address".
2. Select "GPIB Channel Address" and enter a value between 0 and 30.

**Risk of losing remote connection**

If the remote access and network settings had been configured to values different to the default, executing a factory preset via remote control terminates the connection to the instrument.

### 13.8.2 Starting remote control with LXI

Using the LXI browser interface you can access and control the R&S SMW200A instrument remotely from a controller PC without additional installation. Remote control over LXI supports file upload and download between the instrument and the controller PC.

It is assumed that the instrument is set up in the LAN.

See "[Prerequisites](#)" on page 860.

**To start remote control with the LXI browser**

1. On the controller PC, start a browser that supports HTML5 (W3C compliant).
2. Enter the IP address of the R&S SMW200A in the browser's address bar.  
The browser displays the R&S SMW200A's welcome page.
3. In the navigation pane, select "Instrument Control" > "Web Control".  
Remote access to the instrument requires the password. The default password is *instrument*.
4. Enter the password.
5. Confirm with [Enter].  
The current screen of the R&S SMW200A appears in the browser window.
6. Use the mouse cursor and keyboard to access the functionality of the instrument as if you operate the instrument directly.

**To activate SCPI remote trace**

The remote trace functionality allows you to trace SCPI commands and messages exchanged over the LAN of the R&S SMW200A. To communicate with the instrument over SCPI, use a suitable remote control application.

1. Set up the remote control session as described under "[To start remote control with the LXI browser](#)" on page 864.
2. In the navigation pane, select "Diagnostics > SCPI Remote Trace".
3. In the toolbar bar of the "SCPI Remote Trace" page, select "live mode > on".



- Using the remote control program, send your SCPI commands to the R&S SMW200A.

The "SCPI Remote Trace" tab displays all sent commands and responses.

- Select "logging > on".

(Live mode and logging exclude each other).

"logging > on" displays all commands and responses, and traces messages also.

The SCPI remote trace function records all sent commands, received responses and messages, and saves them in an internal database. If "live mode" is disabled, you can display the recent traces on request, using the "refresh" button. You can also save the log in a file.

**Note:** The diagnostics functionality is extended in later releases, e.g. to download or upload SCPI command files from / to the instrument.

### 13.8.3 Starting remote control with VXI-11

This connection uses the I/O software library R&S VISA from Rohde & Schwarz to setup a LAN remote control link to the instrument.

R&S VISA is running on a controller PC with Windows operating system. You can send commands to the instrument and receive the responses.

For information installing, operating and the utility applications the software provides, see R&S VISA product page [www.rohde-schwarz.com/rsvisa](http://www.rohde-schwarz.com/rsvisa).

The remote control connection requires a VISA installation but no additional hardware on the controller PC. The LAN I/O channel is selected at initialization time using the VISA resource string (also referred to as "address string"). A VISA alias (short name) replaces the complete resource string. The host address is the R&S SMW200A's host-name or its IP address.

See [Section 13.2.1, "LAN interface"](#), on page 819.

#### To set up the controller with R&S VISA

To remote control the R&S SMW200A, we use the R&S VISA Tester application. The application communicates over the TCP/IP protocol.

- On the controller PC, install the R&S VISA program.  
See [www.rohde-schwarz.com/rsvisa](http://www.rohde-schwarz.com/rsvisa) > "RS VISA release notes".
- On the instrument, enable the LAN interface and "SCPI over LAN".
- On the controller, start, e.g., "R&S VISA > Tester".

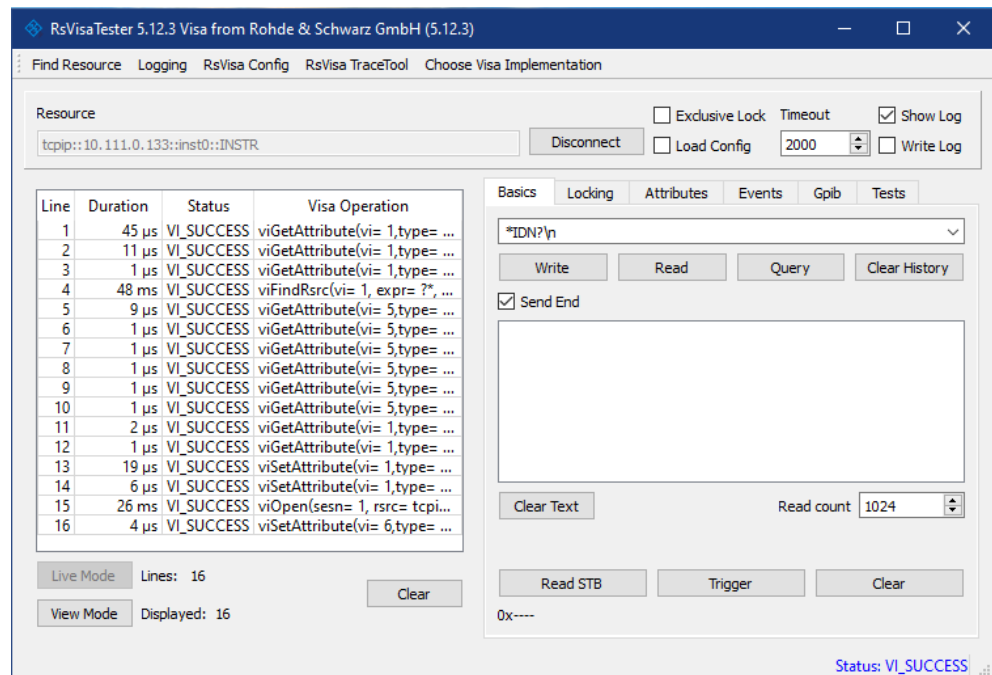

- In the menu bar, select "Choose VISA Implementation > Rohde & Schwarz Visa"
- Confirm with "OK".

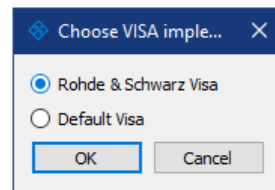

- In the menu bar, select "Find Resource" to search for the instrument in the LAN.

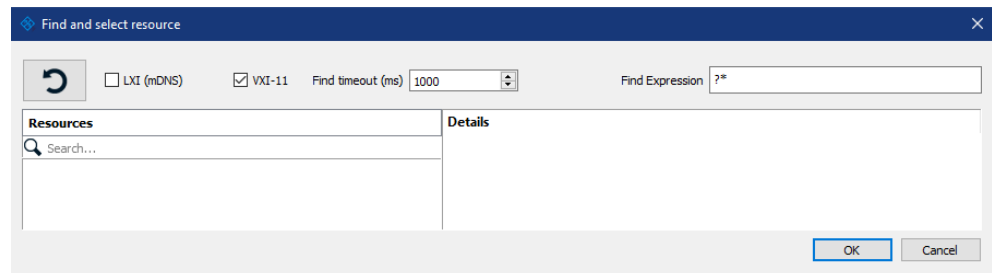

- Select "VXI-11".
- Select the "refresh" button to start the search.  
R&S VISA scans the network for connected instruments and lists all detected instruments in the "Resource" list.  
**Note:** The search can take some time, particularly in large networks.
- Select the required instrument.

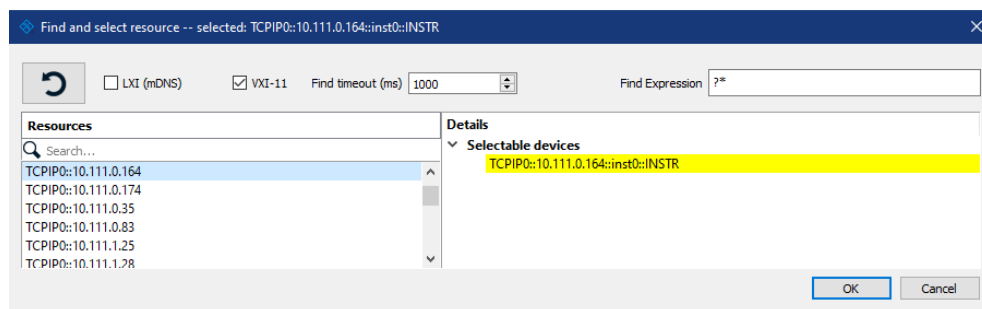

10. Confirm with "Ok".

The "Find and select resource" dialog closes and R&S VISA indicates the IP address in the "Resource" field of the main application window.

11. As an alternative to the IP address, you can assign an alias name to the R&S SMW200A:
- a) In the menu bar, select "RsVisaConfig".

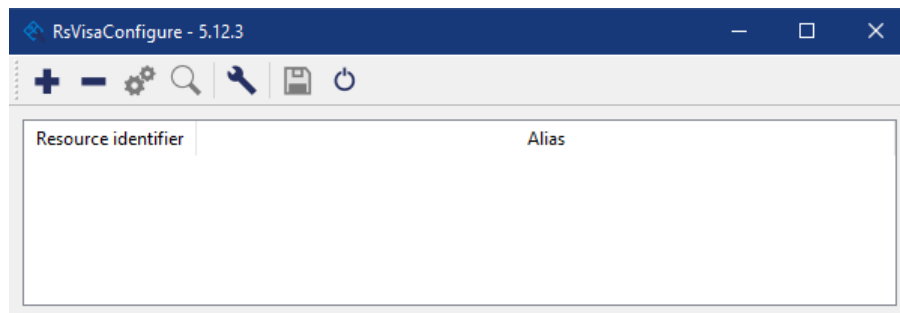

- b) In the toolbar, select "+" to access the "VISA Resource String Composer".

- c) Fill in the "Alias" name, the "VISA Resource String" and the "Device IP Address or hostname" as shown in the figure.

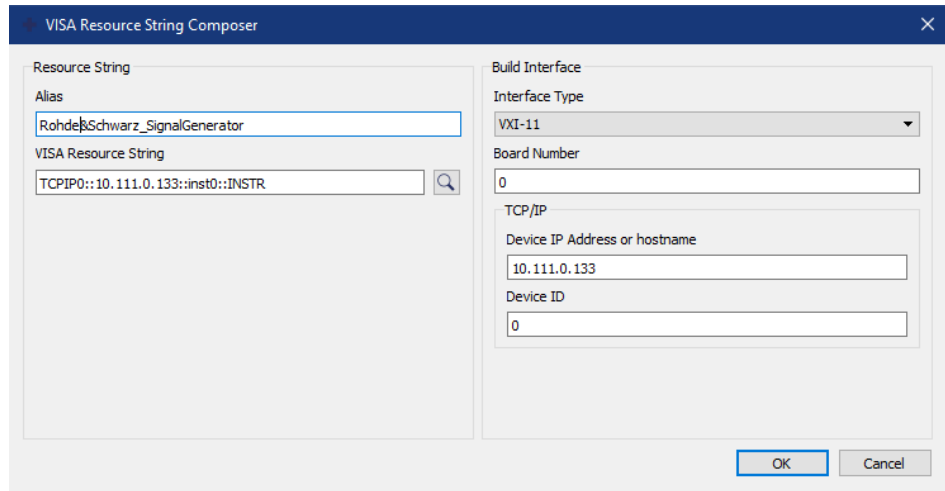

R&S VISA indicates the assigned "Alias" name.

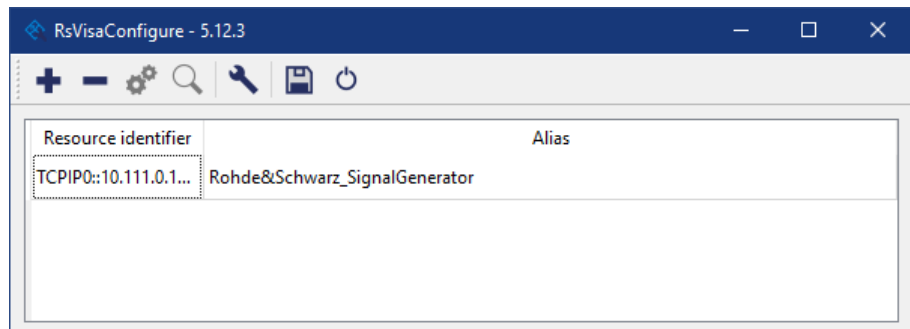

- d) Confirm with "OK".

R&S VISA identifies the R&S SMW200A and you can address it either with the resource string or the alias name.

12. In the main window, select "Connect".

R&S VISA establishes the connection to the R&S SMW200A.

You can send settings to configure the instrument and receive its responses.

**Note:** If the connection cannot be set up, R&S VISA displays an error in the log view.

See also [Section 15.5, "Resolving network connection failures"](#), on page 1345.

### To start remote control with R&S VISA

To set the instrument to remote control state, you can send any command from the controller.

1. Start the R&S VISA Tester.  
Establish the connection to the R&S SMW200A.  
See ["To set up the controller with R&S VISA"](#) on page 865.
2. In the R&S VISA "Basics" tab, enter a SCPI command, e.g. \*IDN?.

## 3. Confirm with "Query".

The instrument switches to remote control when it receives a command from the controller.

## 4. Select "Read" to obtain the instrument response.

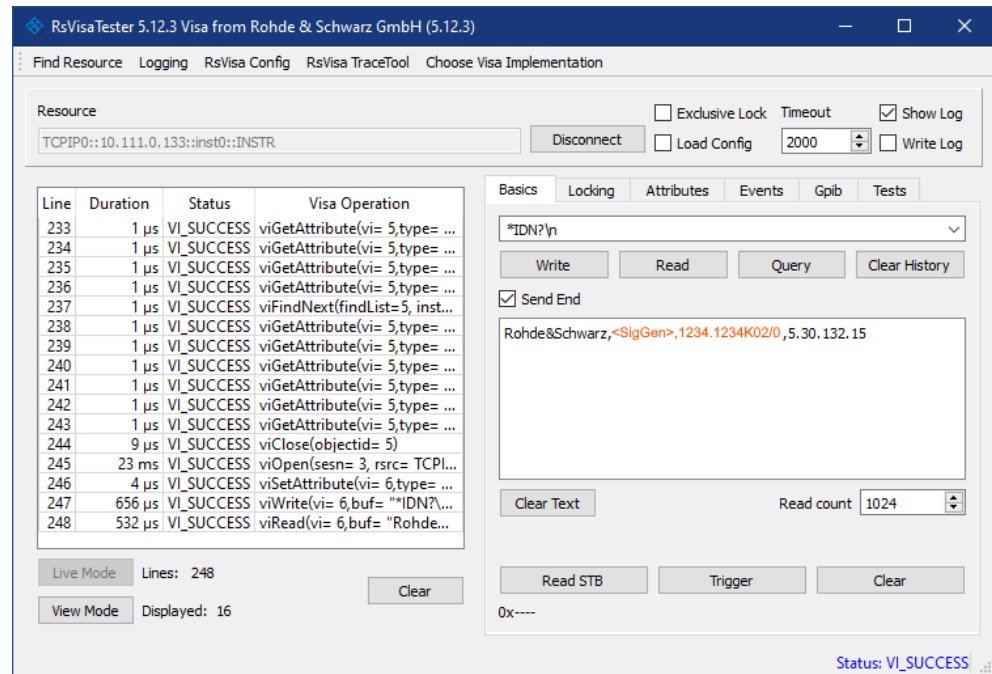

The instrument returns the response.  
Remote control over R&S VISA is enabled.

**To check remote control with VISA**

You can check the communication by sending a setting command and querying the response:

1. Set, e.g. the frequency with the command:  
`SOUR1:FREQ 3 GHz.`
2. Select "Write".
3. Enter the command `SOUR:FREQ?.`
4. Select "Query".

If the R&S SMW200A responds with the frequency value you entered, remote control works properly.

**To monitor the remote control operation**

1. Check the "Show Log" checkbox on the top right.  
R&S VISA displays each VISA operation in the log-view on the left.
2. Check the "Write Log" checkbox.

R&S VISA saves all log-view entries to a log file.

You can operate the log-view in two modes:

- "Live Mode": shows only the most recent messages
- "View Mode" allows you to scroll the history

To return to manual operation, see [Section 13.8.7, "Stopping remote control"](#), on page 872.

### 13.8.4 Starting remote control with socket communication

This section provides an example on how to establish a remote control connection over Telnet client and a simple sockets-based program example that can be further developed.



The telnet client transmits information unencrypted. Therefore, for sensitive information we recommend that you use a client which supports secure protocols, like SSH.

#### To set up a Telnet connection

To control the software, only a Telnet program is required. The Telnet program is part of each operating system.

The controller PC and the instrument are connected in the same network.

1. On the instrument, enable the LAN interface and "SCPI over LAN".  
See [Section 12.7.4, "Configuring LAN services"](#), on page 800.
2. On the controller PC, start the Telnet program.
3. Enter the socket address.

The socket address is a combination of the IP address or the hostname of the R&S SMW200A and the number of the port configured for remote-control via Telnet.

**Tip:** The R&S SMW200A uses the port number 5025 for remote connection via Telnet.

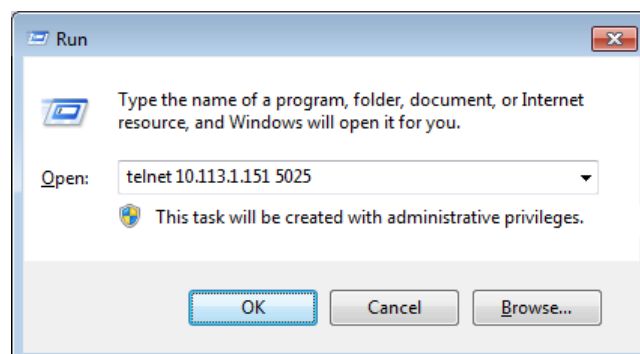

The connection to the instrument is set up and you can send remote-control commands.

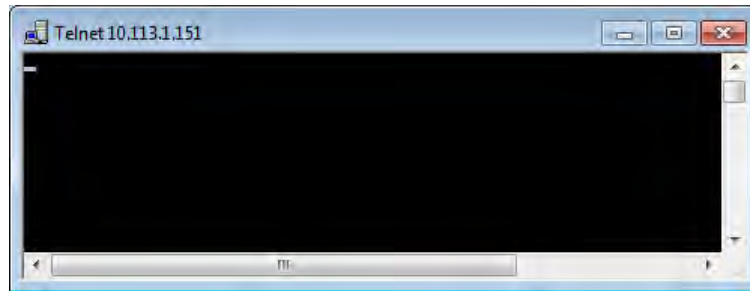

4. Telnet does not reflect your first entry.  
Insert a command, e.g. \*IDN and confirm with "Enter".
5. Observe the screen.  
A response on the query confirms that the connection is working. The client displays all subsequent inputs and responses.
6. Even if the cursor is not visible on the screen, just enter a remote-control command. Confirm with Enter.

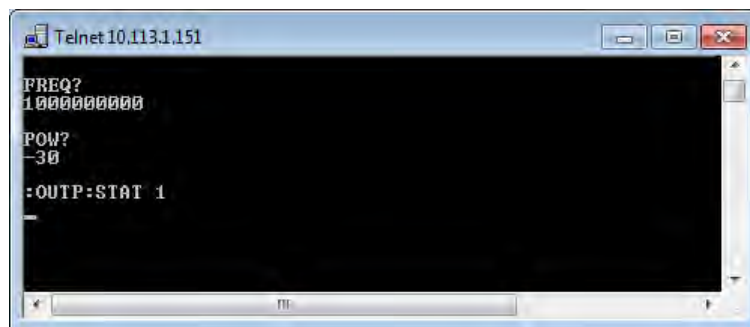

### 13.8.5 Starting remote control over GPIB

The program example in this section is written in VISUAL BASIC. A condition for programming in VISUAL BASIC is that the modules NIGLOBAL (Niglobal.bas) and VBIB32 (Vbib\_32.bas) are added to the projects.



Drivers for instrument, for example IVI-COM and LabVIEW drivers, are available for download area on the product page at:

<https://www.rohde-schwarz.com/driver/smw200a/>

#### To start remote control over GPIB

1. Connect instrument and controller using a GPIB cable.  
Switch them on.
2. Select "System Config > Remote Access > GPIB Address" > "**GPIB Channel Address = 28**".  
The GPIB address of the instrument must be the default value of 28.

3. Execute the following commands on the controller:
  - a) Open the port to the instrument.  
`CALL IBFIND("DEV1", generator%)`
  - b) Inform the controller about instrument address.  
`CALL IBPAD(generator%, 28)`
  - c) Reset the instrument.  
`CALL IBWRT(generator%, "*RST;*CLS")`
  - d) Set the instrument to new address.  
`CALL IBWRT(generator%, "SYST:COMM:GPIB:ADDR 18")`
  - e) Inform the controller about new address.  
`CALL IBPAD(generator%, 18)`

The GPIB address of the instrument is changed.
4. To return to manual operation, see [Section 13.8.7, "Stopping remote control"](#), on page 872.

### 13.8.6 Starting remote control over USB

For remote control, the PC and the instrument must be connected over the USB type B interface. A USB connection requires the VISA library to be installed. VISA detects and configures the R&S instrument automatically when the USB connection is established. You do not have to enter an address string or install a separate driver.

#### To start remote control over USB

1. Connect instrument and controller using USB cable. Switch them on.
2. Execute the following commands on the controller:
  - a) Open the port to the instrument.  
`viOpen (... , "USB::0x0AAD::0x0092::100001::INSTR", ...)`
  - b) Reset the instrument.  
`viRST (generator%, "*RST;*CLS")`
  - c) Set 2 GHz frequency  
`viPrintf (... , "SOUR:FREQ 2GHz\n")`
  - d) Set 20 dBm output level  
`viPrintf (... , "SOUR:POW -20dBm\n")`

The RF frequency and signal level of the instrument are changed.
3. To return to manual operation, see [Section 13.8.7, "Stopping remote control"](#), on page 872.

### 13.8.7 Stopping remote control



Before returning to manual control, command processing must be completed. Otherwise, the instrument switches back to remote control immediately.



You have the following options to switch from remote control to manual operation:

- Closing the remote control session
- Using remote control commands
- Selecting the remote icon in the status bar directly on the screen
- Using the "LOCAL" key

#### To find out active remote connections

- ▶ Check the indication on the taskbar:



A softkey in the taskbar indicates if and what kind of remote connections are currently set up.



See also [Section 13.5.6, "Active remote connection settings"](#), on page 838

#### To return to manual operation

Depending on the used remote control state, the transition from remote control to manual operation requires different actions.

- ▶ Select the corresponding transition action as shown in the table.

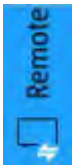
Table 13-6: Remote control status icons

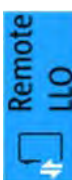
GUI symbol	Transition to remote control state...	Remote control state characteristics	Transition to manual operation...(local state)
	&GTR (controller PC)	Remote control, but usable front panel keys. The parameters are in read-only mode.	<ul style="list-style-type: none"> <li>• &amp;GTL (SCPI) If &amp;NREN has been set before &amp;GTL is locked. Use &amp;GTR instead.</li> <li>• CALL IBLOC (generator%), (visual basic).</li> <li>• viGpibControlREN() (VISA function)</li> <li>• "Remote" icon in the status bar</li> <li>• [LOCAL] (front panel or key emulation)</li> </ul>
		The green arrows indicate a currently performed setting.	The setting must be completed (white arrows) before you can return to manual operation.
	&LLO (controller)	Remote control with locked front panel keys to prevent user interaction. The parameters are in read-only mode. You can unlock LLO, and thus return to manual operation only via remote control.	<ul style="list-style-type: none"> <li>• &amp;LOCS</li> <li>• &amp;REMS</li> <li>• Changes from "Remote LLO" to "Remote" state.</li> <li>• CALL IBLOC (generator%)</li> <li>• viGpibControlREN()</li> </ul>

## 13.9 Using remote command scripts

To configure a test setup quickly, or to make complex test setups or repeating measurements reproducible, you can automate the required settings with remote command scripts. A remote command script contains a sequence of SCPIs which configure the corresponding settings. When created, it is converted to an executable format, saved in a file and can be run whenever needed.

The graph shows the main steps required to create and execute a SCPI script.



Figure 13-7: Steps for performing SCPI Scripts

- [SCPI recording settings](#)..... 874
- [Creating remote command lists](#)..... 878
- [Checking and verifying a remote command list](#)..... 881
- [Converting a remote command list to a script](#)..... 882
- [Running a remote command script](#)..... 884

### 13.9.1 SCPI recording settings

The R&S SMW200A provides information on the required SCPI command for the available measurement settings, functions, and results in the context-sensitive menu.

Access:

1. Select a parameter.
2. Open the context-sensitive menu (tap and hold).



The context-sensitive menu provides the SCPI recording functions to help you create your script.

- [Show SCPI command settings](#).....875
- [SCPI recording list settings](#).....875
- [SCPI recording export settings](#)..... 876

### 13.9.1.1 Show SCPI command settings

Access:

1. Select the parameter.
2. Open the context-sensitive menu.
3. Select "Show SCPI Command".

This function provides the syntax of the remote command with the current setting.

#### Settings:

- [Copy](#).....875
- [Close](#).....875

#### Copy

Copies the command and the current setting.

#### Close

Exits the "SCPI Command" dialog.

### 13.9.1.2 SCPI recording list settings

Access:

1. Select a parameter.
2. Open the context-sensitive menu.
3. Select "Show SCPI Recording List".

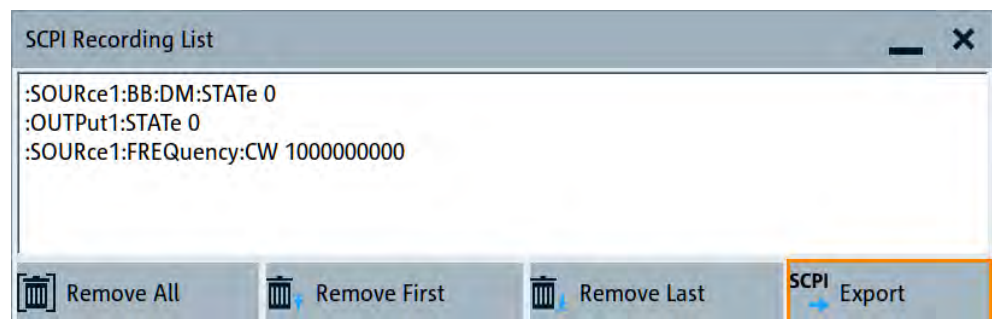

The "SCPI Recording List" shows the recorded commands.

**Settings:**

SCPI Recording List.....	876
Remove All.....	876
Remove First.....	876
Remove Last.....	876
Export.....	876

**SCPI Recording List**

Lists the automatically or manually recorded SCPI commands.

**Remove All**

Deletes all entries in the SCPI command list.

**Remove First**

Deletes the first entry in the SCPI command list.

**Remove Last**

Deletes the last entry in the SCPI command list.

**Export**

Opens the "SCPI Recording Export" dialog for configuring the file parameters for the SCPI command script file.

See [Section 13.9.1.3, "SCPI recording export settings"](#), on page 876.

**13.9.1.3 SCPI recording export settings**

The R&S SMW200A displays recorded remote command lists in the "SCPI Recording Export" dialog. This dialog opens automatically, when you stop recording. To open the dialog manually, proceed as described.

Access:

1. Select a parameter.
2. Open the context-sensitive menu.
3. Select "Show SCPI Recording List".

4. Select "Export".

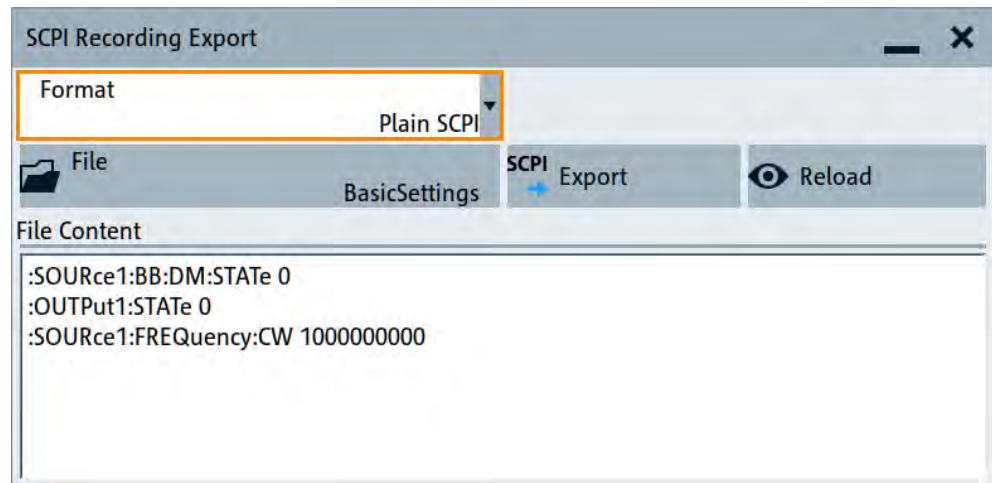

The "SCPI Recording Export" dialog contains all functions required for export of command lists to a file. It enables you to select the source code format, assign an individual filename and display the file content.

#### Settings:

Format.....	877
Code Template.....	877
File.....	877
Export.....	878
Reload.....	878
File content.....	878

#### Format

Selects the source code format for the command list.

"Plain SCPI" Uses SCPI syntax.

"Predefined Code Generator"

Accesses the predefined templates for common source code generators that convert the recorded settings in the programming languages MATLAB or NICVI or Python.

"User Code Generator"

Use this setting to convert a script by a user-specific code generator.

#### Code Template

Opens a standard file handling dialog for saving or loading predefined or user-defined code templates.

See [Section 11.5.1, "File select settings"](#), on page 714.

#### File

Opens a standard file handling dialog for selecting the directory and file name for the output file.

See [Section 11.5.1, "File select settings"](#), on page 714.

**Export**

Saves the remote command list file in the selected directory.

**Reload**

Reloads a remote command list file.

**File content**

Displays the content of the remote command list in the selected format and code template.

## 13.9.2 Creating remote command lists

Using the SCPI recorder functions, you can create a SCPI command list directly on the instrument and then export the list for use on the controller PC. You can also edit or write a script manually, using a suitable editor on the controller. For manual creation, you can retrieve the command corresponding to a setting directly on the instrument.

You can create a SCPI list directly on the instrument at any time of operation, in the following ways:

- Recording settings automatically  
The "Start SCPI Recording" function adds the SCPI command of each step that you perform to the SCPI list. You can start, stop and resume automatic recording, and also add individual commands manually.  
See ["To record settings automatically"](#) on page 878.
- Recording settings manually  
The "Add SCPI Command to Recording List" function adds the SCPI command and settings value of an individual step to the SCPI list.  
See ["To record settings manually"](#) on page 879.
- Generating a SCPI command list of all settings in one step  
Adds the SCPI commands of the current instrument settings in one step in a SCPI list.  
See ["To generate a SCPI command list of all settings in one step"](#) on page 880.  
**Note:** This function lists all commands in alphabetical order, in contrast to the recording or manual creation, which consider the order the settings are configured. If a setting cannot be set by a SCPI command, *no SCPI command found* is entered instead of a command when generate all settings at once.  
Using this function can slow down the performance or cause errors during execution.  
Therefore, always check and revise a script if necessary.  
See ["To display a remote command list"](#) on page 881 and ["To review a remote command list"](#) on page 881.
- Copying and pasting individual SCPI commands manually  
"Show SCPI command" enables you to copy the SCPI command and the current setting and paste it into any suitable editor.  
See ["To copy and paste SCPI commands"](#) on page 879.

**To record settings automatically**

1. On the screen, open the context-sensitive menu.

2. Select "Start SCPI recording".

 A rectangular button with a dark grey background. On the left, there is a black circle icon. To the right of the icon, the text "Start SCPI Recording" is written in white.

The R&S SMW200A now records all steps you take.

3. To stop SCPI recording, select "Stop SCPI recording" in the context-sensitive menu.



 A rectangular button with a dark grey background. On the left, there is a black square icon. To the right of the icon, the text "Stop SCPI Recording" is written in white.

The "SCPI Recording List" dialog opens.

4. Proceed with ["To review a remote command list"](#) on page 881.

#### To record settings manually

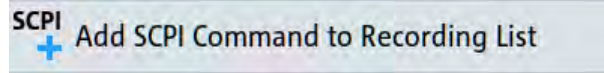
1. Select the parameter or function.
2. Set the parameter.
3. Open the context-sensitive menu.
4. Select "Add SCPI Command to Recording List".

 A rectangular button with a light grey background. On the left, there is a blue plus sign icon. To the right of the icon, the text "Add SCPI Command to Recording List" is written in dark grey. The word "SCPI" is written in a smaller font above the plus sign.

The R&S SMW200A adds the SCPI command of the setting including the value in a temporary SCPI command list.

**Tip:** "Context-Sensitive > Show SCPI Recording List" opens the dialog with the recorded settings.

 A rectangular button with a light grey background. On the left, there is a list icon (three horizontal lines with small squares at the end). To the right of the icon, the text "Show SCPI Recording List (4) ..." is written in dark grey.

5. Continue with the next setting accordingly whenever you want to record it.
6. Proceed with ["To review a remote command list"](#) on page 881.

#### To copy and paste SCPI commands

1. On the instrument, select the parameter or function.
2. Set the parameter.
3. Open the context-sensitive menu.
4. Select "Show SCPI Command".

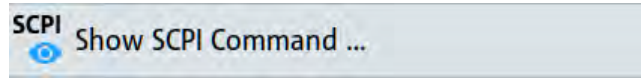
 A rectangular button with a light grey background. On the left, there is a blue eye icon. To the right of the icon, the text "Show SCPI Command ..." is written in dark grey. The word "SCPI" is written in a smaller font above the eye icon.

The R&S SMW200A displays the syntax and the setting value of the SCPI command.

With the "Copy" function, you can copy and paste the SCPI command and setting value, e.g., in a command script on a PC.

### To generate a SCPI command list of all settings in one step

Using the save/recall function, you can create a SCPI command list for all settings in one step.

1. Press the [Save/Recall] key.

The instrument opens the standard "Save/Recall" dialog.

2. Select "Operating mode" > "SCPI Export".

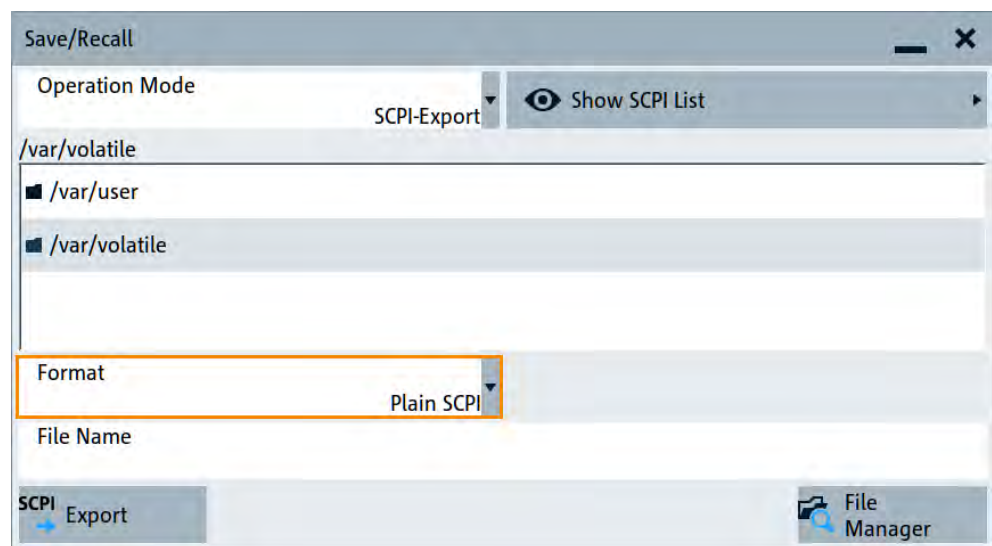

The dialog adjusts the entry fields for configuring the command list file. "Show SCPI List" provides access to the list of all settings the instrument has recorded.

3. Select the "/var/user" directory in which you want to save the SCPI command list.
4. In the "Format" entry field, select the source code format.
5. Enter a filename.
6. Select "Export".

The R&S SMW200A saves the SCPI command list as \*.txt file.

**Note:** Exporting the SCPI list of the instrument state in one step usually requires postprocessing on an external PC, as this function lists all instrument states and commands in alphabetical order.

In contrast, recording or manual creation of a SCPI command list considers the order the settings are configured.



### 13.9.3 Checking and verifying a remote command list

Before converting a command list to an executable script, we recommend that you check if the entries are correct and complete. It can be that ...

- a parameter has not assigned a SCPI command or an element of the user interface has not an assigned parameter. In these cases, `:SYST:INF:SCPI 'SCPI command not available'` is entered in the list instead.  
Such entries are also detected during execution. The instrument recognizes these incomplete commands and displays notification.
- a preset has been executed, but several standards then perform some internal settings that are also assigned to the list with "SCPI Export".
- after a preset some settings are still defined, which are then written to the list generated with "SCPI Export."

#### To display a remote command list

On the instrument, you have different options to access a remote command list.

1. During automatic or manual recording:
  - a) Open the context-sensitive menu.
  - b) Select "Show SCPI Recording List".
2. At the end of automatic recording:
  - a) Open the context-sensitive menu.
  - b) Select "Stop SCPI Recording".
3. After exporting a command list to a file.
  - a) Select "SCPI Recording Export" > "Show file content".  
The "SCPI Recording List" opens.

#### To review a remote command list

To rework a remote command list, you must transfer it to a computer.

1. Export the list to a PC, using, for example, a USB flash drive.
2. Check the list, e.g. by comparing it with the modified settings in the manual mode.  
**Tip:** To find out your settings, you can use the "Mark all parameters changed from preset" function.  
See [Section 11.2.2, "Identifying parameters with non-default values"](#), on page 705.
3. Search for missing or incomplete command entries.
  - a) Add missing commands.
  - b) Complete missing parts of commands.
  - c) Remove superfluous entries, e.g. `:SYST:INF:SCPI 'SCPI command not available'`.
  - d) Remove unnecessary content written after a preset.

4. Rearrange the commands to a reasonable order. For example, if you set a `STATE` command to the last position in a list, you can avoid intermediate calculations of the signal.

### 13.9.4 Converting a remote command list to a script

For conversion of a remote command list into an executable script, a code generator translates the commands into the source code of a proprietary programming language, based on a code template. Therefore, each programming language requires a dedicated code template.

The R&S SMW200A provides the following predefined code templates by default:

- Plain SCPI  
Represents SCPI base format, that is ASCII format, saved as text file (\*.txt).
- MATLAB  
A programming environment, frequently used in signal processing and test and measurement applications (\*.m).  
You can directly use this format with MATLAB(c) Toolkit. For comprehensive information on this topic, refer to the application note [1GP60](#).
- NICVI  
An ANSI C programming environment designed for measurements and tests (\*.c).  
You can directly use this format with National Instruments LabWindows CVI.
- Python3  
A general-purpose and high-level programming language (\*.py).

You can also convert a script to a user-specific format. In this case, you need a code template with the extension \*.expcodetmpl.

When converted, you can save the script in a file with the extension corresponding to the programming language.

#### To configure a plain SCPI script file

1. Select "Show SCPI Recording List" in the context-sensitive menu.
2. Select "Export".  
The "SCPI Recording Export" dialog opens.
3. Select the "Format" > "Plain SCPI".
4. Select "File".  
A standard file handling dialog opens.
5. Configure filename and directory and confirm with "Ok".
6. In the "SCPI Recording Export" dialog, select "Export".  
The R&S SMW200A saves the recorded data in \*.txt format. The "File Content" section shows the SCPI commands of the script file.

**To convert the command list to a predefined code template**

1. Select "Show SCPI Recording List" in the context-sensitive menu.
2. Select "Export".  
The "SCPI Recording Export" dialog opens.
3. In the "SCPI Recording Export" dialog, select "Format" > "Predefined Code Generator".  
The "CodeTemplate" button appears.
4. Select "Code Template".  
The "SCPI Recording Export - Select Predefined Code Template" dialog opens.
5. Select a predefined code template, e.g., "MATLAB".
6. Confirm with "Select".  
The R&S SMW200A returns to the "SCPI Recording Export" dialog.
7. Select "File".  
A standard file handling dialog opens.
8. Configure filename and directory and confirm with "Ok".
9. In the "SCPI Recording Export" dialog, select "Export".  
The R&S SMW200A saves the recorded data in the corresponding format. The "File Content" section shows the content of the script file in the corresponding programming language.

**To convert the command list to a user-defined code template**

Before creating a script in a user-specific format, make sure that you have saved the code template with the file extension `*.expcodetmpl` in the instrument.

1. Select "Show SCPI Recording List" in the context-sensitive menu.
2. In the "SCPI Recording Export" dialog, select "Format" > "Use Code Generator".  
The "CodeTemplate" button appears.
3. Select "Code Template".  
The "SCPI Recording Export - Select User Code Template" dialog opens.
4. Select your user-defined code template.
5. Confirm with "Select".  
The R&S SMW200A returns to the "SCPI Recording Export" dialog.
6. Select "File".  
A standard file handling dialog opens.
7. Configure filename and directory and confirm with "Ok".
8. In the "SCPI Recording Export" dialog, select "Export".

The R&S SMW200A saves the recorded data in the corresponding format. The "File Content" section shows the content of the script file in the corresponding programming language.

### 13.9.5 Running a remote command script

An executable script automates measurement tasks on the instrument. Usually controlled by a remote PC, you can also save and run a script directly in the instrument by assigning the script to the [USER] key.

See [Section 12.4.2, "How to assign actions to the \[USER\] key"](#), on page 767.

## 13.10 Setting up remote operation over VNC

VNC accesses the R&S SMW200A over LAN from a remote device using a web browser or a VNC client. With the screen displayed on the controller, you can control the instrument as if you operate it directly. Establishing the access depends on the used remote device and VNC client software.

### Prerequisites

For remote operation, make sure that you have fulfilled the following prerequisites:

- The instrument and the controller PC are connected in the same network.  
See [Section 3.1.7, "Connecting to LAN"](#), on page 32.
- The instrument and the controller are switched on.
- The LAN interface and VNC LAN service is enabled.  
See [Section 12.7.4, "Configuring LAN services"](#), on page 800.
- A suitable application is running on the remote device.
  - Web browser  
The R&S SMW200A supports remote operation over VNC with any web browser, e.g., Windows Internet Explorer, Mozilla Firefox, or an HTML5 web browser.
  - VNC client software  
Linux/Unix operating systems include a VNC client software by default.  
For remote devices with windows operating system a VNC client software must be installed manually. Various free-of charge programs such as Ultr@VNC or similar VNC client programs are available for download on the Internet.



### VNC client software

Linux/Unix operating systems include a VNC client software by default.

For remote devices with windows operating system a VNC client software must be installed manually. Various free-of charge programs such as Ultr@VNC or similar VNC client programs are available for download on the Internet.



If security is a concern, see:

- Document Instrument Security Procedures.
- [Section 12.7.6, "Preventing unauthorized access"](#), on page 806.

See [Section 13.1, "Overview of remote access modes"](#), on page 817.

The following examples describe how to set up remote operation with remote devices:

- Using a controller PC
  - ["To operate the instrument from a web browser over VNC"](#) on page 886
  - ["To operate the instrument from a Linux/Unix client over VNC"](#) on page 886
  - ["To operate the instrument from a Windows client over VNC"](#) on page 887
- Using a smart device
  - ["To operate the instrument using a VNC App on a smart device"](#) on page 889
  - ["To operate the instrument from a web browser over VNC"](#) on page 886
  - ["To access the instrument with QR code on a smart device"](#) on page 890

#### To enable VNC service on the R&S SMW200A

1. **NOTICE!** Enabled VNC service can lead to unauthorized access.  
Change the computer name and password of the instrument.  
See [Section 12.7.6, "Preventing unauthorized access"](#), on page 806.
2. Select "System Config > Setup > Security > Security".
3. Select "LAN Services > Common Services".
4. Enable "VNC".
5. Enter the [Security Password](#).
6. Confirm with "Accept".

• <a href="#">Using a controller PC</a> .....	885
• <a href="#">Using a smart device</a> .....	888
• <a href="#">Stopping remote operation</a> .....	890

### 13.10.1 Using a controller PC

#### Prerequisites

For remote operation from a controller PC, make sure that you have fulfilled the following prerequisites:

- The instrument and the controller PC are connected in the same network.  
See [Section 3.1.7, "Connecting to LAN"](#), on page 32.
- The instrument and the controller are switched on.
- The LAN interface and VNC LAN service is enabled.  
See [Section 12.7.4, "Configuring LAN services"](#), on page 800.

- A suitable application is running on the remote device.
  - Web browser  
The R&S SMW200A supports remote operation over VNC with any web browser, e.g., Windows Internet Explorer, Mozilla Firefox, or an HTML5 web browser.
  - VNC client software  
Linux/Unix operating systems include a VNC client software by default. For remote devices with windows operating system a VNC client software must be installed manually. Various free-of charge programs such as Ultr@VNC or similar VNC client programs are available for download on the Internet.



#### VNC client software

Linux/Unix operating systems include a VNC client software by default.

For remote devices with windows operating system a VNC client software must be installed manually. Various free-of charge programs such as Ultr@VNC or similar VNC client programs are available for download on the Internet.

#### To operate the instrument from a web browser over VNC

1. Install the *JRE (Java Runtime Environment)* on the remote computer.  
**Note:** Skip this step if you are working with an HTML5 web browser.
2. Enter the IP address of the instrument in the address field of the web browser, e.g. *http://10.113.1.151*  
The VNC authentication screen appears.
3. Enter the user password.  
The default password is *instrument*.
4. Confirm with with "OK".

When the VNC connection is established, the screen of the signal generator appears and you can operate the instrument from the remote computer.

#### To operate the instrument from a Linux/Unix client over VNC

1. Start a web browser on the remote computer. Enter the IP address of the instrument.
2. Enter the following address:  
`vnc://<IP-address of the instrument>, for example vnc://10.113.1.151.`  
A dialog opens requesting the password for the remote VNC connection.
3. Enter the user password.  
The default password is *instrument*.
4. Confirm with with "OK".

When the VNC connection is established, the screen of the signal generator appears and you can operate the instrument from the remote computer.

### To operate the instrument from a Windows client over VNC

1. Install the VNC viewer program component on the remote computer.
  - a) Download a VNC client program from the Internet.  
For example the free of charge software Ultr@VNC (`vncviewer.exe` is available, see <http://www.uvnc.com/download/index.html>).
  - b) Execute the VNC client installation.
  - c) Select the VNC viewer program component and follow the installation instructions.
2. Start VNC viewer program component on the PC.

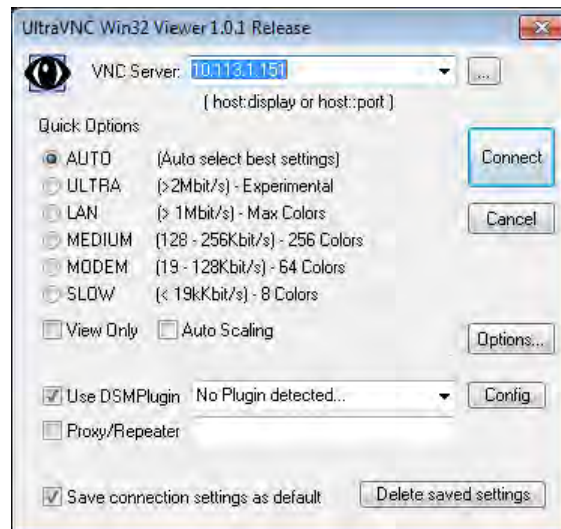

3. Select "VNC Server"
4. Enter the IP address of the instrument.
5. Confirm with "Connect".

An authentication dialog opens.

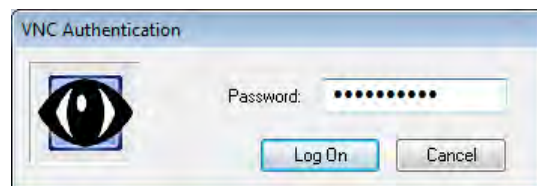

6. Enter the user password for authentication.  
The default password is *instrument*.
7. Confirm with "LogOn".

When the connection is established, the screen of the signal generator appears and you can operate the instrument from the remote computer.

### 13.10.2 Using a smart device

The R&S SMW200A supports remote operation over VNC from a smart device (remote client), like a tablet (tablet computer) or a smartphone. The smart device accesses the instrument over WLAN, either by a suitable App, or an HTML5 web browser with embedded *javascript*.

There are several possibilities to establish a WLAN connection between the smart device and the R&S SMW200A. This section gives an example of how a network environment can be built up, and some essential configuration steps.

For more information, see:

- [1MA216: Remote Operation of Windows Based Instruments with Apple iPad](#)
- [7BM82: Apple iPad Remote Control of Broadcasting T&M Instruments](#)

#### Example:

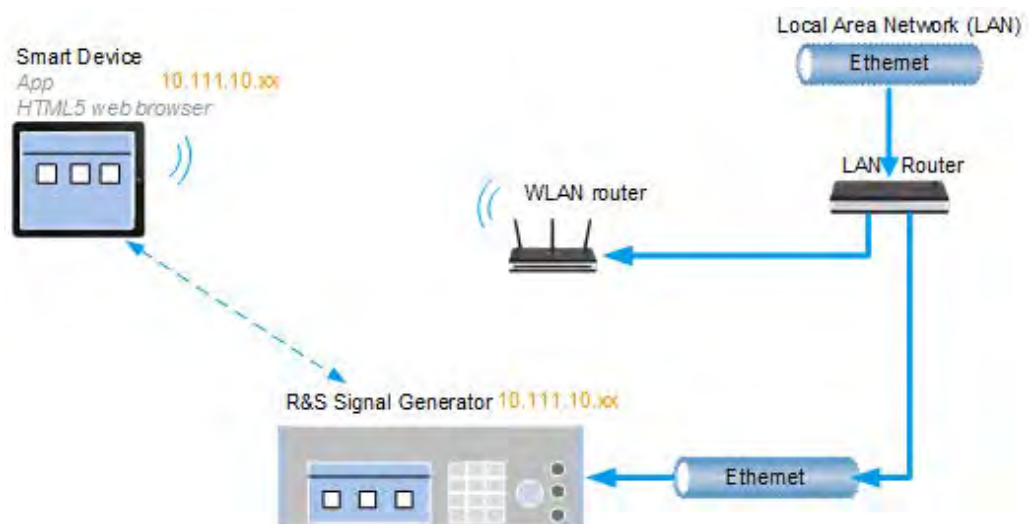

Figure 13-8: Example of a network configuration for remote operation with a smart device

As shown in the figure, the R&S SMW200A and the WLAN router are connected to the LAN router. The smart device accesses the Rohde & Schwarz instrument via the WLAN router.

The WLAN router as an additional access point enables you to operate the instrument even from a great distance.

#### Prerequisites

For the remote operation, you need the following equipment and configuration:

- Equipment:
  - LAN router
  - WLAN router (hot spot) for accessing the instrument
  - Smart device
- The instrument and the smart device PC are connected in the same network.
- The instrument and the smart device are switched on.



- The LAN interface and VNC LAN service is enabled.  
See [Section 12.7.4, "Configuring LAN services"](#), on page 800.
- A suitable application is running on the smart device.
  - Web browser  
The R&S SMW200A supports remote operation over VNC with any HTML5 compliant web browser, e.g., Internet Explorer, Firefox, Google Chrome or Safari.
  - VNC app  
An application that implements the VNC functionality for remote operation. The VNC App must be suitable to the used smart device.  
Refer to the manufacturer's website to find a VNC App supported for your smart device, and how it is installed.
  - QR code  
If your smart device is equipped with a camera and a QR code reader, you can scan the instrument's IP address or access the instrument with the Safari web browser.  
Refer to the manufacturer's website to find a QR code reader supported for your smart device, and how it is installed.

We recommend that all components in the network use DHCP, which automatically assigns the relevant address information.

#### To operate the instrument using a VNC App on a smart device

1. Set up the network connection as shown in [Figure 13-8](#)
2. Configure the WLAN router according to the manufacturer's instructions.
3. Install the required *VNC App* on your smart device.
4. On the smart device, start the *VNC App*.  
Enter the IP address of the instrument in the address field of *VNC App*.  
The VNC authentication screen appears.
5. Enter the user password.  
The default password is *instrument*.
6. Enter the password to establish the remote access.  
The default user name and password is *instrument*.

When the VNC connection is established, the screen of the signal generator appears and you can operate the instrument from the smart device.

#### To operate the instrument from a web browser over VNC

1. Install the *JRE (Java Runtime Environment)* on the remote computer.  
**Note:** Skip this step if you are working with an HTML5 web browser.
2. Enter the IP address of the instrument in the address field of the web browser, e.g. *http://10.113.1.151*  
The VNC authentication screen appears.

3. Enter the user password.  
The default password is *instrument*.
4. Confirm with with "OK".  
  
When the VNC connection is established, the screen of the signal generator appears and you can operate the instrument from the remote computer.

#### To access the instrument with QR code on a smart device

1. Set up the network connection as shown in [Figure 13-8](#)
2. Configure the WLAN router according to the manufacturer's instructions.
3. Install the required QR code reader software on your smart device.
4. On the smart device, start the QR code reader.
5. On the R&S SMW200A, select "System Config > Remote Access".
6. Select the "QR-Code" tab.
7. Scan the QR code of the instrument with your smart device.
8. On the smart device, decode the scanned QR code and forward it to the web browser.  
  
The VNC authentication screen appears.
9. Enter the user password.  
The default password is *instrument*.

When the VNC connection is established, the screen of the signal generator appears and you can operate the instrument from the smart device.

### 13.10.3 Stopping remote operation

#### To stop remote operation

To terminate remote operation over VNC depends on the used client:

- ▶ Select the action that applies to the used client:
  - a) On an external Unix/Linux PC, close the Internet browser or the signal generator window.
  - b) On an external Windows PC, close the VNC viewer program.
  - c) On a smart device, close the application.

The connection is terminated but not disabled. It can be established again anytime.

## 13.11 References

### 13.11.1 LXI functionality

LAN Extensions for Instrumentation (LXI) is an instrumentation platform for measuring instruments and test systems that is based on standard Ethernet technology.

LXI is intended to be the LAN-based successor to GPIB, combining the advantages of Ethernet with the simplicity and familiarity of GPIB. Like GPIB, LXI determines and standardizes the way the instrument behaves in a LAN.

The LXI implementation in the R&S SMW200A allows you to change certain LAN settings, to reset the LAN connection, and to identify the instrument.



For information about the LXI standard, refer to the LXI website at <https://www.lxistandard.org>.

See also "News from Rohde & Schwarz, article 2006/II - 190".

The LXI functionality in the R&S SMW200A is characterized by a common LAN implementation, including an ICMP ping responder for diagnostics. Using a web browser, you can configure the instrument. A LAN Configuration Initialize (LCI) mechanism resets the LAN configuration. The instrument also supports automatic detection in a LAN via the VXI-11 discovery protocol and programming by IVI drivers.

In addition, the R&S SMW200A provides the following LXI-related functionality:

- Integrated "LXI Status" dialog for LXI status indication and reset of the LAN configuration, see [Section 13.6, "LXI status settings"](#), on page 851.
- "LXI Browser Interface", as described in [Section 13.7.1, "LAN configuration"](#), on page 855.
- "SCPI Remote Trace" utility, see [Section 13.7.2, "SCPI remote trace"](#), on page 857.



#### Firmware update

To enable the full LXI functionality after a firmware update, shut down and restart the instrument.

### 13.11.2 Code generator templates

This section describes the main structure of the code generator templates, and shows the method with the NICVI template.

The code generation is controlled by templates with the following blocks:

Command	Function
#EXTENSION_START #EXTENSION_END	Defines the output file extension.
#INIT_CODE_START #INIT_CODE_END	Contains initial entries, such as included files and libraries, buffer size, commands for synchronization, or creating a VISA session.  All entries between start and end are written once at the beginning of the output file.
#COMMAND_CODE_START #COMMAND_CODE_END	Frame for a SCPI command. A command is accessed with %COMMAND.
#NO_COMMAND_CODE_START #NO_COMMAND_CODE_END	Frame for a parameter with no SCPI command available. A parameter is accessed with %PARAMETER.
#EXIT_CODE_START #EXIT_CODE_END	Closes the visa session.  All entries between start and end are written once at the end of the output file.

Templates are created in ASCII format with file extension \*.expcodetempl.

### Example:

Example to the code generator template NICVI.expcodetmpl:

```
#EXTENSION_START
.c
#EXTENSION_END

#INIT_CODE_START
#include <ansi_c.h>
#include <visa.h>
#include <cvirte.h>

#define MAX_BUFFER_SIZE 200
static ViStatus status;
static ViSession defaultRM, handle;

static void write_command(char *command)
{
    char writeBuffer[MAX_BUFFER_SIZE];
    char readBuffer[MAX_BUFFER_SIZE];
    int length;
    int readCount;

    strcpy(writeBuffer, command);
    //append "*OPC?" to sync
    strcat(writeBuffer, "*OPC?");
    length = strlen (writeBuffer);
    writeBuffer[length]='\n';
```

```
        length = length+1;
        viWrite (handle, writeBuffer, length, VI_NULL);
        //read result
        viRead(handle, readBuffer, 100, &readCount);
    }
int main (int argc, char *argv[])
{
    if (InitCVIRTE (0, argv, 0) == 0)
        return -1;    /* out of memory */
        //create a VISA session and return a handle to it
    viOpenDefaultRM (&defaultRM);
        //create a VISA session to the serial port and return a handle to it
    viOpen (defaultRM, (ViRsrc)"TCPIP::localhost::INSTR", VI_NULL, VI_NULL,
&handle);
#INIT_CODE_END

#COMMAND_CODE_START
    write_command("%COMMAND");
#COMMAND_CODE_END

#NO_COMMAND_CODE_START
    //no SCPI command available for parameter %PARAMETER !
#NO_COMMAND_CODE_END

#EXIT_CODE_START
    viClose (handle);
        viClose (defaultRM);
        return 0;
}
#EXIT_CODE_END
```

# 14 Remote control commands

In the following, all remote-control commands are presented in detail with their parameters and the ranges of numerical values.

For an introduction to remote control and the status registers, see [Section 13, "Network operation and remote control"](#), on page 816.

• <a href="#">Conventions used in SCPI command descriptions</a> .....	894
• <a href="#">Backward compatibility with other Rohde &amp; Schwarz signal generators</a> .....	895
• <a href="#">SCPI command aliases for advanced mode with multiple entities</a> .....	896
• <a href="#">Programming examples</a> .....	898
• <a href="#">Common commands</a> .....	898
• <a href="#">Preset commands</a> .....	903
• <a href="#">MMEMory subsystem</a> .....	904
• <a href="#">CALibration subsystem</a> .....	917
• <a href="#">CLOCK subsystem</a> .....	922
• <a href="#">DIAGnostic subsystem</a> .....	923
• <a href="#">HUMS remote control commands</a> .....	926
• <a href="#">DISPlay subsystem</a> .....	933
• <a href="#">FORMat subsystem</a> .....	937
• <a href="#">HCOPY subsystem</a> .....	939
• <a href="#">KBOARD subsystem</a> .....	944
• <a href="#">OUTPUT subsystem</a> .....	945
• <a href="#">SENSe, READ, INITiate and SLISt subsystems</a> .....	948
• <a href="#">SCONfiguration subsystem</a> .....	963
• <a href="#">SOURce subsystem</a> .....	1005
• <a href="#">SYSTEM subsystem</a> .....	1295
• <a href="#">STATus subsystem</a> .....	1326
• <a href="#">TEST subsystem</a> .....	1330
• <a href="#">TRIGger subsystem</a> .....	1337
• <a href="#">UNIT subsystem</a> .....	1339

## 14.1 Conventions used in SCPI command descriptions

The following conventions are used in the remote command descriptions:

- *Command usage*  
If not specified otherwise, commands can be used both for setting and for querying parameters.  
If a command can be used for setting or querying only, or if it initiates an event, the usage is stated explicitly.
- *Parameter usage*  
If not specified otherwise, a parameter can be used to set a value, and it is the result of a query.  
Parameters required only for setting are indicated as "Setting parameters".  
Parameters required only to refine a query are indicated as "Query parameters".

## Backward compatibility with other Rohde &amp; Schwarz signal generators

Parameters that are only returned as the result of a query are indicated as "Return values".

- *Conformity*  
Commands that are taken from the SCPI standard are indicated as "SCPI confirmed". All commands used by the R&S SMW200A follow the SCPI syntax rules.
- *Asynchronous commands*  
A command which does not automatically finish executing before the next command starts executing (overlapping command) is indicated as an "Asynchronous command".
- *Reset values (\*RST)*  
Default parameter values that are used directly after resetting the instrument (\*RST command) are indicated as "\*RST" values, if available.
- *Factory preset values*  
Default parameter values that are reset only by factory preset.
- *Default unit*  
The default unit is used for numeric values if no other unit is provided with the parameter.
- *Manual operation*  
If the result of a remote command can also be achieved in manual operation, a link to the description is inserted.

## 14.2 Backward compatibility with other Rohde & Schwarz signal generators

To allow you to use your existing scripts, the R&S SMW200A accepts also a defined subset of SCPI parameter values of other Rohde & Schwarz signal generators, like the R&S SMU. The R&S SMW200A accepts these values and maps them automatically to the corresponding newly introduced parameters.



### Handling of parameters provided for backward compatibility with other Rohde & Schwarz signal generators

The parameter values provided for backwards compatibility are "setting only" values; the query commands return the corresponding new value.

#### Example:

```
SOURce1:BB:ARbitrary:TRIGger:SOURce EXTernal
```

The backwards compatibility parameter value `EXTernal` is accepted

```
SOURce1:BB:ARbitrary:TRIGger:SOURce?
```

Response: `EGT1`

The query returns the correct new value

## 14.3 SCPI command aliases for advanced mode with multiple entities

When working in *Advanced mode*, the R&S SMW200A can generate the signal of several entities. An entity is a *self-contained independent system*, consisting of a baseband source, a fading simulator, a noise generator (AWGN), and an RF part.

Additional *baseband*, *fading*, and *AWGN* SCPI commands are provided to allow consistent addressing of the entities in remote control. All these commands start with the mnemonic (keyword) **ENTity**.

The additional SCPI commands are not listed in this description because their syntax is straightforward: the mnemonic **ENTity** is prepended to the existing SCPI header.

### Addressing entities in remote control

You can address entities in remote control via keywords **ENTity** and **Source**. Consider the interdependency in the suffix ranges. Note also, that the meaning of the keyword **SOURce<hw>** changes.

The figures [Figure 14-1](#) and [Figure 14-2](#) highlight the differences. The figures illustrate the same LxMxN configuration but address the entities in the following two ways:

- By using the SCPI commands starting with the keyword **SOURce**.

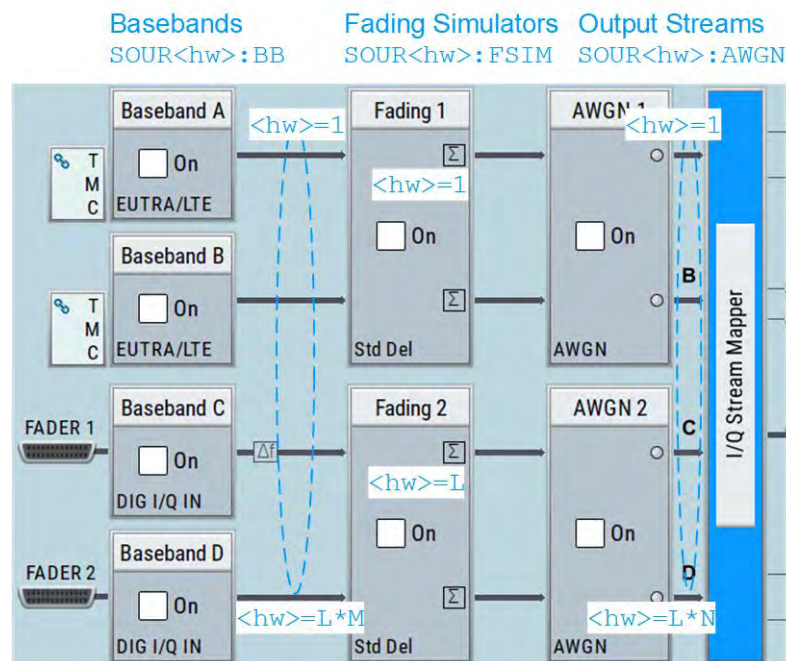

Figure 14-1: *Source<hw> only representation*

- By using the alias commands that start with the keyword **ENTity**.



SCPI command aliases for advanced mode with multiple entities

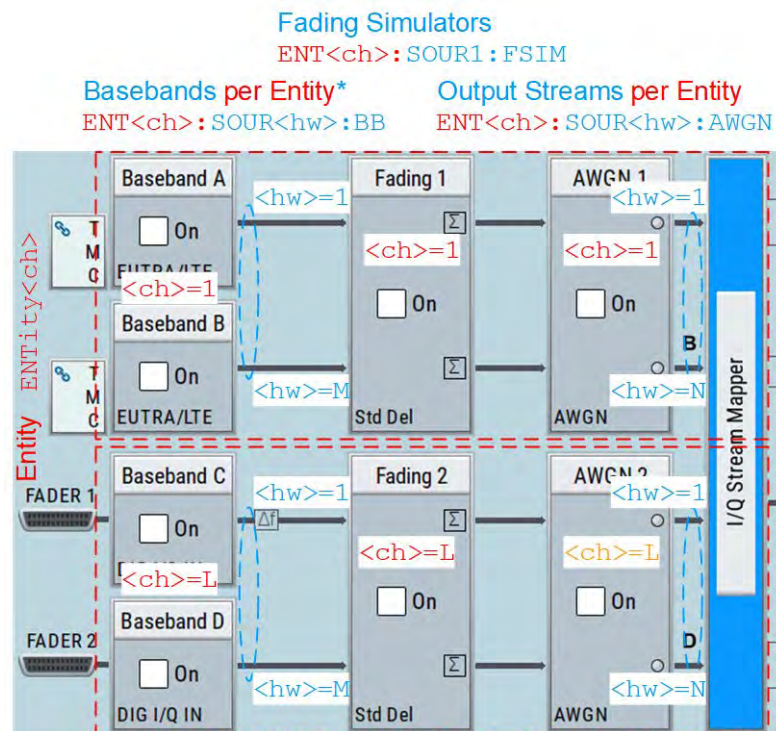

Figure 14-2: ENTity<ch>:SOURce<hw> combination

\*) applies for:

- SOUR:BB:FOFF | POFF | PGA
- SOUR:BBIN: . . .
- SOUR:BB: . . . , if separate baseband sources are used

LxMxN is the short form of the used system configuration, where:

- L represents the Entity
- M the Baseband
- N the Stream

**Example:**

- "System Configuration > Mode > Advanced"
- "Entities = 2", "Basebands = 2", "Streams = 2"
- "BB Source Config > Separate Source"

The command ENTity2:SOURce1:BB:EUTRa:STATE 1 enables the generation of an EUTRA/LTE signal in the first baseband within the second entity.

It is equivalent to :SOURce3:BB:EUTRa:STATE 1.

Logically, also the following command pairs are equivalent to each other:

- ENTity2:SOURce1:FSIMulator:STATE and SOURce2:FSIMulator:STATE
- ENTity2:SOURce1:AWGN:STATE and SOURce3:AWGN:STATE
- ENTity2:SOURce1:BB:FOFF and SOURce3:BB:FOFF

- `ENTity2:SOURce1:BBIN:DIG:SOUR` and `SOURce3:BBIN:DIG:SOUR`



You can find the corresponding commands also with the "Show SCPI command" functions in the context menu of parameters.

See [Section 13.9.1.1, "Show SCPI command settings"](#), on page 875.

## 14.4 Programming examples

The corresponding sections of the same title provide simple programming examples for the R&S SMW200A. The purpose of these examples is to present all commands for a given task. Real applications require application-specific sets of commands and configurations.

The programming examples have been tested with a software tool which provides an environment for the development and execution of remote tests. To keep the examples as simple as possible, only the "clean" SCPI syntax elements are reported. Non-executable command lines start with two characters `//`, for example, comments.

At the beginning of the most remote control program, an instrument preset or reset is recommended to set the R&S SMW200A to a definite state. The commands `*RST` and `SYSTem:PRESet` are equivalent for this purpose. `*CLS` also resets the status registers and clears the output buffer.

In all the examples we assume the following:

- A remote PC is connected to the instrument.
- The remote PC and the instrument are switched on.
- A connection between them is established.
- The security setting "System Config" > "Setup" > "Security" > "SCPI over LAN" is enabled.

## 14.5 Common commands

Common commands are described in the IEEE 488.2 (IEC 625-2) standard. These commands have the same effect and are employed in the same way on different devices. The headers of these commands consist of "\*" followed by three letters. Many common commands are related to the Status Reporting System.

Available common commands:

<code>*CLS</code> .....	899
<code>*ESE</code> .....	899
<code>*ESR?</code> .....	899
<code>*IDN?</code> .....	899
<code>*IST?</code> .....	900
<code>*OPC</code> .....	900
<code>*OPT?</code> .....	900

*PRE.....	900
*PSC.....	901
*RCL.....	901
*RST.....	901
*SAV.....	901
*SRE.....	902
*STB?.....	902
*TRG.....	902
*TST?.....	902
*WAI.....	903

---

**\*CLS**

Clear status

Sets the status byte (STB), the standard event register (ESR) and the `EVENT` part of the `QUESTIONABLE` and the `OPERATION` registers to zero. The command does not alter the mask and transition parts of the registers. It clears the output buffer.

**Usage:**                   Setting only

---

**\*ESE <Value>**

Event status enable

Sets the event status enable register to the specified value. The query returns the contents of the event status enable register in decimal form.

**Parameters:**

&lt;Value&gt;                   Range:     0 to 255

---

**\*ESR?**

Event status read

Returns the contents of the event status register in decimal form and then sets the register to zero.

**Return values:**

&lt;Contents&gt;               Range:     0 to 255

**Usage:**                   Query only

---

**\*IDN?**

Identification

Returns the instrument identification.

**Return values:**

&lt;ID&gt;                       "Rohde&amp;Schwarz,&lt;device type&gt;,&lt;part number&gt;/&lt;serial number&gt;,&lt;firmware version&gt;"

<b>Example:</b>	Rohde&Schwarz, SMW200A, 1412.0000K02/102030, 4.00.023
<b>Usage:</b>	Query only
<b>Manual operation:</b>	See " <a href="#">IDN String</a> " on page 838 See " <a href="#">Hardware Options/Software Options</a> " on page 1352

---

**\*IST?**

Individual status query

Returns the contents of the IST flag in decimal form. The IST flag is the status bit which is sent during a parallel poll.

**Return values:**

<ISTflag>            0 | 1

**Usage:**            Query only

---

**\*OPC**

Operation complete

Sets bit 0 in the event status register when all preceding commands have been executed. This bit can be used to initiate a service request. The query writes a "1" into the output buffer when all preceding commands have been executed, which is useful for command synchronization.

---

**\*OPT?**

Option identification query

Queries the options included in the instrument. For a list of all available options and their description, refer to the specifications document.

**Return values:**

<Options>            The query returns a list of options. The options are returned at fixed positions in a comma-separated string. A zero is returned for options that are not installed.

**Usage:**            Query only

**Manual operation:** See "[OPT String](#)" on page 838  
See "[Hardware Options/Software Options](#)" on page 1352

---

**\*PRE <Value>**

Parallel poll register enable

Sets parallel poll enable register to the indicated value. The query returns the contents of the parallel poll enable register in decimal form.

**Parameters:**

<Value>                      Range:     0 to 255

**\*PSC <Action>**

Power on status clear

Determines whether the contents of the `ENABLE` registers are preserved or reset when the instrument is switched on. Thus a service request can be triggered when the instrument is switched on, if the status registers ESE and SRE are suitably configured. The query reads out the contents of the "power-on-status-clear" flag.

**Parameters:**

<Action>                      0 | 1

**0**

The contents of the status registers are preserved.

**1**

Resets the status registers.

**\*RCL <Number>**

Recall

Loads the instrument settings from an intermediate memory identified by the specified number. The instrument settings can be stored to this memory using the command `*SAV` with the associated number.

It also activates the instrument settings which are stored in a file and loaded using the `MMEMory:LOAD <number>, <file_name.extension>` command.

**Manual operation:**    See "[Quick Recall x](#)" on page 712

**\*RST**

Reset

Sets the instrument to a defined default status. The default settings are indicated in the description of commands.

The command is equivalent to `SYSTem:PRESet`.

**Usage:**                      Setting only

**Manual operation:**    See "[Preset](#)" on page 704

**\*SAV <Number>**

Save

Stores the current instrument settings under the specified number in an intermediate memory. The settings can be recalled using the command `*RCL` with the associated number.

To transfer the stored instrument settings in a file, use the command `:MMEMory:STORe:STATe`.

**Manual operation:** See "Quick Save x" on page 711

#### **\*SRE <Contents>**

Service request enable

Sets the service request enable register to the indicated value. This command determines under which conditions a service request is triggered.

#### **Parameters:**

<Contents>                      Contents of the service request enable register in decimal form.  
Bit 6 (MSS mask bit) is always 0.  
Range:                      0 to 255

#### **\*STB?**

Status byte query

Reads the contents of the status byte in decimal form.

**Usage:**                      Query only

#### **\*TRG**

Trigger

Triggers all actions waiting for a trigger event. In particular, \*TRG generates a manual trigger signal. This common command complements the commands of the TRIGger subsystem.

\*TRG corresponds to the INITiate:IMMEDIATE command.

**Usage:**                      Event

#### **\*TST?**

Self-test query

Initiates self-tests of the instrument and returns an error code.

#### **Return values:**

<ErrorCode>                      **integer > 0 (in decimal format)**  
An error occurred.  
(For details, see the Service Manual supplied with the instrument).  
**0**  
No errors occurred.

**Usage:**                      Query only

**\*WAI**

Wait to continue

Prevents servicing of the subsequent commands until all preceding commands have been executed and all signals have settled (see also command synchronization and \*OPC).

**Usage:** Event

## 14.6 Preset commands

The preset commands are not bundled in one subsystem. Therefore, they are listed separately in this section.

In addition, a specific preset command is provided for each digital standard. These specific commands are described in the associated subsystems.

Four presetting actions are available:

- Activating the default state of all internal instrument functions (\*RST on page 901). Functions that concern the integration of the instrument into a measurement setup are not changed, e.g. reference oscillator source settings.
- Activating the preset state of the parameters related to the selected signal path (:SOURCE<hw>:PRESet on page 904)
- Activating the preset state of all parameters that are not related to the signal path (:DEVICE:PRESet on page 903)
- Activating the original state of delivery (factory reset, :SYSTEM:FPreSet on page 904). Only functions that are protected by a password remain unchanged as well as the passwords themselves.



When resetting, the following deviation between remote and manual control exists:

In contrast to the [PRESET] key, the SCPI commands \*RST and :SYSTEM:PRESet do not close open dialogs in the GUI.

:DEVICE:PRESet.....	903
:SOURCE<hw>:PRESet.....	904
:SYSTEM:PRESet.....	904
:SYSTEM:FPreSet.....	904

### :DEVICE:PRESet

Presets all parameters which are not related to the signal path, including the LF generator.

**Example:** DEV:PRESet  
Presets all instruments settings that are not related to the signal path.

**Usage:** Event

---

**:SOURce<hw>:PRESet**

Supported in 2x1x1 configurations:

- `:SCONfiguration:MODESTANdard`
- `:SCONfiguration:MODEADVanced` with  
`:SCONfiguration:FADingFAAFBB`

Presets all parameters which are related to the selected signal path.

Fading simulator (if available) and the transient recorder are only preset by the command `*RST`.

**Example:** `SOUR:PRES`  
Presets all settings that are related to signal path

**Usage:** Event

---

**:SYSTem:PRESet**

Triggers an instrument reset. It has the same effect as:

- The [PRESET] key.  
However, the command does not close open GUI dialogs like the key does.
- The `*RST` command

For an overview of the settings affected by the preset function, see [Table 11-1](#)

**Example:** `SYST:PRES`  
All instrument settings (also the settings that are not currently active) are reset to their default values.

**Usage:** Setting only

---

**:SYSTem:FPReset**

Triggers an instrument reset to the original state of delivery.

**Example:** `SYST:FPR`  
All instrument settings (also the settings that are not currently active) are reset to the factory values.

**Usage:** Event

**Manual operation:** See "[Execute Factory Preset](#)" on page 705

---

## 14.7 MMEMory subsystem

The MMEMory subsystem (Mass MEMory) contains the commands for managing files and directories as well as for loading and saving complete instrument settings in files.



### Mass storage location

Without any additional measures, the R&S SMW200A stores user files on the internal memory or if connected, on a memory stick.

Both, the user directory `/var/user/` on the internal memory or the `/usb/` directory on the memory stick, can be used to **preserve** user-defined data. Any directory structure can be created.

The `/var/volatile` directory serves as a RAM drive and can be used to protect sensitive information. The data is available **temporarily**.

### Default storage location

The R&S SMW200A stores user data in the user directory.

In the file system, user directory is always indicated as `/var/user/`.

In manual control, you access this directory via the "File Manager", see [Section 11.8, "Using the file manager"](#), on page 719. In remote control, you can query it with the command `:SYSTEM:MMEMory:PATH:USER?`.

To query and change the default directory used for mass storage, use the command `:MMEMory:CDIRectory`.

## 14.7.1 File naming conventions

To enable files to be used in different file systems, consider the following file naming conventions:

- The *filename* can be of any length and *is case-sensitive*, i.e. it is distinguished between uppercase and lowercase letters.
- All letters and numbers are permitted (numbers are, however, not permitted at the beginning of the filename).
- Avoid using special characters.
- Do not use slashes "\" and "/". These symbols are used in file paths.
- Avoid using the following filenames: CLOCK\$, CON, COM1 to COM4, LPT1 to LPT3, NUL or PRN  
They are reserved by the operating system.

### File extension

The file and the optional file *extension* are separated by a period sign. The R&S SMW200A distinguishes the files according to their extensions; each type of file is assigned a specific file content and hence a specific file extension. Refer to [Section A, "Available user files and file extensions"](#), on page 1378 for an overview of the supported file extensions.

### Wildcards

The two characters "\*" and "?" function as "wildcards", i.e. they are used for selecting several files. The "?" character represents exactly one character, while the "\*" charac-

ter represents all characters up to the end of the filename. "\*" therefore represents all files in a directory.

### Filename and file path

When used in remote control commands, the parameter `<filename>` is specified as a string parameter with quotation marks. It can contain either the complete path including the root user directory `/var/user` and filename, or only the filename. The filename must include the file extension. The same applies for the directory `/var/volatile` and for the parameters `<directory_name>` and `<path>`.

Depending on how much information is provided, the values specified in the parameter or with the command `MMEM:CDIR` are used for the path and drive setting in the commands.

## 14.7.2 Handling files in the default or in a specified directory

For better overview and easy file handling, you may not save all user files in the user directory `/var/user` but rather organize them into subdirectories.

The command syntax defines two general ways to access files with user data in a *specific* directory:

- **Change the current default directory** for mass memory storage and then directly access the files in this default directory, like saved list files, files with user data or save/recall files.  
(See [Example "Save the user settings in a file in a specific directory"](#) on page 906).  
The subsequent commands for file handling (select, delete, read out files in the directory, etc.) require only specification of the filename. File extension can be omitted; after syntax evaluation of the used command, the R&S SMW200A filters out the relevant files.
- Define the **complete file path**, including the user directory `/var/user`, created subdirectories and filename.  
As a rule, whenever an complete file path is determined, it overwrites a previously specified default directory.

The following example explains this rule as a principle. Exceptions of this general rule are stated in the description of the corresponding command. The [Section 14.7.3, "Programming examples"](#), on page 907 explains the general working principle with the commands for mass memory storage.

The same rule applies to the `/var/volatile` directory, see [Example "Working with files in the volatile memory"](#) on page 909.

### Example: Save the user settings in a file in a specific directory

This example uses the commands for saving and loading files with custom digital modulation settings. We assume that the directory `/var/user/DigMod` is existing and contains the files `SaveRecallTest.dm` and `dmSavRcl.dm`.

```
// Set the default directory first
MMEMory:CDIRectory "/var/user/DigMod"
SOURcel:BB:DM:SETTing:CATalog?
// "SaveRecallTest","dmSavRcl"

// Specify only the file name; the extension *.dm is assigned automatically
SOURcel:BB:DM:SETTing:STORe "dmSettings"
SOURcel:BB:DM:SETTing:DELeTe "dmSavRcl"
SOURcel:BB:DM:SETTing:LOAD "SaveRecallTest"
SOURcel:BB:DM:SETTing:CATalog?
// "SaveRecallTest","dmSettings"
```

Working with the files of other subsystems or files containing the settings of a particular digital standard (e.g. `SOURcel:BB:EUTra:SETTing:...`), is analogical.

#### Example: Load file with user data from a specific directory

This example shows how to use the custom digital modulation commands to set the data source and select a data list. We assume that the directory `/var/user/lists` is existing and contains the files `dlist1.dm_iqd` and `myDList.dm_iqd`.

```
// Select a data list file as data source
SOURcel:BB:DM:SOURce DLIST

// Query the data list files (*.dm_iqd) in the default directory
MMEMory:CDIRectory "/var/user/lists"
SOURcel:BB:DM:DLISt:CATalog?
// "dlist1","myDList"

// Specify the complete path to select a data list file (*.dm_iqd)
// in the specific directory
MMEMory:CDIRectory
SOURcel:BB:DM:DLISt:SElect "/var/user/lists/myDList"
SOURcel:BB:DM:DLISt:DELeTe "/var/user/lists/dlist1"
```

Working with other list files, like control lists (`...:CLISt:...`) or lists with modulation data (`...:MLISt:...`), and the handling of data list files of other subsystems or of a particular digital standard (like `SOURcel:BB:EUTra:...:DSElect`), is analogical.

### 14.7.3 Programming examples

#### Example: Saving and loading current settings

This example shows two ways of how to save the current instrument setting in the file `settings.savrcl.txt` in the directory `/var/user/savrcl`.



Before the instrument settings can be saved in a file, they have to be saved in an intermediate memory using common command `*SAV <number>`. The specified number is then used in the `:MMEMory:STORe:STATe` command.

Also, after loading a file with instrument settings with command `:MMEMory:LOAD:STATe`, these settings have to be activated with the common command `*RCL <number>`.

```
// Save the current settings in an intermediate memory with number 4
*SAV 4

// save the settings in a file in a specific directory;
// the complete path has to be specified
MMEMory:STORe:STATe 4,"/var/user/savrcl/settings.savrcltxt"

// save the settings in a file in the default directory;
// set the default directory; specify only the file name
MMEMory:CDIRectory "/var/user/savrcl"
*SAV 4
MMEMory:STORe:STATe 4,"settings.savrcltxt"

// Load the saved settings in the intermediate memory 4 and activate them
MMEMory:LOAD:STATe 4,"/var/user/settings.savrcltxt"
*RCL 4
```

### Example: Working with files and directories

This example shows how to list files in a directory, list the subdirectories, query the number of files in a directory, create directory, rename and delete files.

```
// Query the current default directory for mass storage,
// change the directory to the default user directory "/var/user"
// and read out the files in it
MMEMory:CDIRectory?
// "/var/user/temp"
MMEMory:CDIRectory
MMEMory:CDIRectory?
// "/var/user/"
MMEMory:CATalog?
// 1282630,8102817792,".,DIR,4096","..,DIR,4096","Log,DIR,4096",
// "settings.savrcltxt,BIN,16949","temp,DIR,4096","test,DIR,4096",
// "list.lsw,BIN,1245201"
// the directory "/var/user" contains the predefined directory "Log",
// the subdirectories "test" and "temp"
// as well as the files "settings.savrcltxt" and "list.lsw"

// query only the subdirectories of the current or specified directory
MMEMory:DCATalog? "/var/user"
// ".","..","Log","temp","test"
```

```

// query only number of subdirectories in the current or specified directory
MMEMory:DCATalog:LENGth? "/var/user"
// 5

// query number of files in the current or specified directory
MMEMory:CATalog:LENGth? "/var/user"
// 7

// Create a new directory for mass memory storage in the specified directory
MMEMory:MDIRectory "/var/user/new"

// Copy the file "settings.savrc1txt" into the new directory
MMEMory:COpy "/var/user/settings.savrc1txt","/var/user/new/settings.savrc1txt"

// Rename the file "settings.savrc1txt" into the new directory
// and read out the files in this specific directory
MMEMory:CDIRectory "/var/user/new"
MMEMory:MOve "settings.savrc1txt","settings_new.savrc1txt"
MMEMory:CATalog? "/var/user/new"
// 25141,8102789120,".",DIR,4096","..,DIR,4096","settings_new.savrc1txt,BIN,16949"

// Delete an empty directory, e.g. the "test" directory
MMEMory:RDIRectory "/var/user/test"
// Delete the entire directory, including files and subdirectories
:MMEMory:RDIRectory:RECurSive "var/user/test"

```

### Example: Working with files in the volatile memory

This example shows how to work with files in the `/var/volatile` directory.

```

// Change the default directory for mass storage,
// read out the files, load and play a file with the ARB
MMEMory:CDIRectory "/var/volatile"
MMEMory:CDIRectory?
// "/var/volatile"
MMEMory:CATalog?
//13928,525352960,".",DIR,60","..,DIR,4096","list.lst,BIN,9772"

SOURcel:LIST:SElect "/var/volatile/list"
SOURcel:FREQuency:MODE LIST
OUTPut1:STATe 1

```

## 14.7.4 Remote control commands

:MMEMory:CATalog?	910
:MMEMory:CATalog:LENGth?	910
:MMEMory:CDIRectory	910
:MMEMory:COpy	911
:MMEMory:DATA	911

:MMEMory:DATA:UNPRotected.....	912
:MMEMory:DCATalog?.....	914
:MMEMory:DCATalog:LENGth?.....	914
:MMEMory:DELeTe.....	914
:MMEMory:LOAD:STATe.....	914
:MMEMory:MDIRectory.....	915
:MMEMory:MOVE.....	915
:MMEMory:MSIS.....	915
:MMEMory:RDIRectory.....	916
:MMEMory:RDIRectory:RECURSive.....	916
:MMEMory:STORE:STATe.....	916
:MEMory:HFRee?.....	917

---

### :MMEMory:CATalog?

Returns the content of a particular directory.

#### Return values:

<Catalog> string  
 String parameter to specify the directory.  
 If you leave out the path, the command returns the contents of the directory selected with `:MMEMory:CDIRectory`.  
 The path may be relative or absolute.

**Example:** See [Example "Working with files and directories"](#) on page 908.

**Usage:** Query only

**Manual operation:** See ["Directory, File List and Filename"](#) on page 710

---

### :MMEMory:CATalog:LENGth? [<Path>]

Returns the number of files in the current or in the specified directory.

#### Query parameters:

<Path> string  
 String parameter to specify the directory. If the directory is omitted, the command queries the content of the current directory, queried with `:MMEMory:CDIRectory` command.

#### Return values:

<FileCount> integer  
 Number of files.

**Example:** See [Example "Working with files and directories"](#) on page 908.

**Usage:** Query only

---

### :MMEMory:CDIRectory <Directory>

Changes the default directory for mass memory storage. The directory is used for all subsequent `MMEM` commands if no path is specified with them.

**Parameters:**

<Directory> <directory\_name>  
String containing the path to another directory. The path can be relative or absolute.  
To change to a higher directory, use two dots '..'.

**Example:** See [Example "Working with files and directories"](#) on page 908.

**Manual operation:** See ["Directory, File List and Filename"](#) on page 710  
See ["Directory and Filename"](#) on page 720

**:MMEMory:COPY** <SourceFile>, <DestinationFile>

Copies an existing file to a new file. Instead of just a file, this command can also be used to copy a complete directory together with all its files.

**Setting parameters:**

<SourceFile> string  
String containing the path and file name of the source file

<DestinationFile> string  
String containing the path and name of the target file. The path can be relative or absolute.  
If <DestinationFile> is not specified, the <SourceFile> is copied to the current directory, queried with the [:MMEMory:CDIRectory](#) command.

**Note:** Existing files with the same name in the destination directory are overwritten without an error message.

**Example:** See [Example "Working with files and directories"](#) on page 908.

**Usage:** Setting only

**Manual operation:** See ["Cut, Copy&Paste and Delete"](#) on page 721

**:MMEMory:DATA** <Filename>, <BinaryData>**:MMEMory:DATA?** <Filename>

The setting command writes the block data <BinaryBlock> to the file identified by <Filename>.

Set the GPIB-bus terminator to `EOI` to ensure correct data transfer.

The query command transfers the specified file from the instrument to the GPIB-bus and then on to the controller. It is important to ensure that the intermediate memory on the controller is large enough to take the file. The setting for the GPIB-bus terminator is irrelevant.

**Tip:** Use this command to read/transfer stored instrument settings or waveforms directly from/to the instrument.

**Parameters:**

<BinaryData>

**Setting parameters:**

<Filename> string  
String parameter to specify the name of the file.

**Query parameters:**

<Filename> #<number><length\_entry><data>  
#: Hash sign; always comes first in the binary block  
<number>: the first digit indicates how many digits the subsequent length entry has  
<length\_entry>: indicates the number of subsequent bytes  
<data>: binary block data for the specified length.  
For files with a size with more than nine digits (gigabytes), the instrument allows the syntax #(<Length>), where <Length> is the file size in decimal format.

**Example:**

```
MMEMory:DATA '/var/user/test.txt',#15hallo
Writes the block data to the file test.txt.
The digit 1 indicates a length entry of one digit; the digit 5 indicate a length of the binary data (hallo) in bytes.
MMEMory:DATA? '/var/user/test.txt'
Sends the data of the file test.txt from the instrument to the controller in the form of a binary block.
Response: #15hallo
```

**:MMEMory:DATA:UNPRotected <Msus>, <Data>**

The **setting** command sends the I/Q data and the marker data to the file defined with the <Msus> parameter. The required tags are created automatically so that the file content follows the waveform file format.

The **query** reads out the I/Q data part or the marker information of the specified file.

Waveform files can also be created with the command [:SOURce<hw>]:BB:ARBitrary:WAVEform:DATA. In this case, the *complete content* of the waveform file must be specified, i.e. not only the I/Q or marker data but all required tags.

(see [Section 5.7.5, "Tags for waveforms, data and control lists"](#), on page 335).

**Parameters:**

<Msus> <Identifier>:<file name>  
Mass Storage Unit Specifier  
A string that specifies whether I/Q data (NVWFM) or marker data (NVMKR) is transferred and the file name the data is stored in.  
If the file with the specified name does not exist, a file is created. Any existing content in the file is *overwritten*.  
Complete file path and file extension can also be specified. If omitted, files are stored in the default directory and the extension \*.wv is assigned to the file name.

**Setting parameters:**

<Data> block data



I/Q data or marker binary data, where the number of marker elements has to be equal to the number of I/Q samples

Binary block data follows the syntax:

```
#<Digits><Length><IQ00...IxQx...IN-1QN-1> or
#<Digits><Length><M0M1...Mx...MN-1>
```

**#**

Indicates the start of the data block

**<Digits>**

Decimal value

Gives the number of decimal digits used for the <Length> value

**<Length>**

Decimal value

Number of bytes that follow in the <Binary data> part

**IQ00...IxQx...IN-1QN-1**

*Binary data* in ASCII format

*IxQx* represents binary data (16-bit signed integer in 2's complement notation) containing the I and Q component alternately and starting with the I component. Each I and Q component consists of 2 bytes in MSB format (most significant byte first).

The values of the 2 bytes in an I component and a Q component are in the range: -32767 to +32767.

**M0M1...Mx...MN-1**

*Binary data* in ASCII format

*Mx* represents one marker byte, where only the 4 least significant bits are used. These 4 bits are assigned to the 4 possible markers of the instrument, 1 bit per marker: Bit<sub>0</sub> = Marker 1 to Bit<sub>3</sub> = Marker 4.

One 4-bit marker element is required for every I/Q sample.

**Example:**

```
:MMEM:DATA:UNPR "NVWFM:/var/user/wave.wv",#220<IQ00..IxQx>
// the binary data <IQ00..IxQx> is added to a file named wave.wv
// and saved in the selected directory
// <IQ00..IxQx> contains of 20 bytes, i.e. 5 I/Q samples,
// 2 bytes for each I and Q component
// <IQ00..IxQx> is a placeholder;
// the actual ASCII values are not printable
```

```
MMEMory:DATA:UNPRotected? "NVWFM:/var/user/wave.wv"
MMEMory:DATA:UNPRotected "NVMKR:/var/user/wave.wv",#15<M0M1...M5>
// the specified marker data is added to a file named wave.wv
// in the specified directory
// used are printable values;
// used are only the 4 least significant bits of a byte
MMEMory:DATA:UNPRotected? "NVMKR:/var/user/wave.wv"
// note that, the query returns binary values
SOURCE1:BB:ARbitrary:WAVEform:CLOCK "/var/user/wave.wv",1.1E6
SOURCE1:BB:ARbitrary:WAVEform:CLOCK? "/var/user/wave.wv"
```

---

**:MMEMory:DCATalog?**

Returns the subdirectories of a particular directory.

**Return values:**

<DCatalog>                    <file\_entry>  
Names of the subdirectories separated by colons. The first two strings are related to the parent directory.

**Example:**                    See [Example "Working with files and directories"](#) on page 908.

**Usage:**                      Query only

---

**:MMEMory:DCATalog:LENGth? [<Path>]**

Returns the number of subdirectories in the current or specified directory.

**Query parameters:**

<Path>                         string  
String parameter to specify the directory. If the directory is omitted, the command queries the contents of the current directory, to be queried with [:MMEMory:CDIRectory](#) command.

**Return values:**

<DirectoryCount>            integer  
Number of parent and subdirectories.

**Example:**                    See [Example "Working with files and directories"](#) on page 908.

**Usage:**                      Query only

---

**:MMEMory:DELeTe <Filename>**

Removes a file from the specified directory.

**Setting parameters:**

<Filename>                    string  
String parameter to specify the name and directory of the file to be removed.

**Example:**                    See [Example "Working with files and directories"](#) on page 908.

**Usage:**                      Setting only

**Manual operation:**    See ["Cut, Copy&Paste and Delete"](#) on page 721

---

**:MMEMory:LOAD:STATe <SavRclStateNumb>, <file\_name>**

Loads the specified file stored under the specified name in an internal memory.

After the file has been loaded, the instrument setting must be activated using an [\\*RCL](#) command.

**Setting parameters:**

<SavRclStateNumb> Determines to the specific <number> to be used with the \*RCL command, e.g. \*RCL 4.

<file\_name> String parameter to specify the file name with extension \*.savrc1txt.

**Example:** See [Example "Saving and loading current settings"](#) on page 907.

**Usage:** Setting only

**Manual operation:** See ["Recall"](#) on page 712

**:MMEMory:MDIRectory <Directory>**

Creates a subdirectory for mass memory storage in the specified directory. If no directory is specified, a subdirectory is created in the default directory. This command can also be used to create a directory tree.

**Setting parameters:**

<Directory> string  
String parameter to specify the new directory.

**Example:** See [Example "Working with files and directories"](#) on page 908.

**Usage:** Setting only

**Manual operation:** See ["Create New Directory"](#) on page 721

**:MMEMory:MOVE <SourceFile>, <DestinationFile>**

Moves an existing file to a new location or, if no path is specified, renames an existing file.

**Setting parameters:**

<SourceFile> string  
String parameter to specify the name of the file to be moved.

<DestinationFile> string  
String parameters to specify the name of the new file.

**Example:** See [Example "Working with files and directories"](#) on page 908.

**Usage:** Setting only

**Manual operation:** See ["Rename"](#) on page 721

**:MMEMory:MSIS <Path>**

Defines the drive or network resource (in the case of networks) for instruments with windows operating system, using `msis` (MSIS = Mass Storage Identification String).

**Note:** Instruments with Linux operating system ignore this command, since Linux does not use drive letter assignment.

---

**:MMEMory:RDIRectory** <Directory>

Removes an empty directory from the mass memory storage system. If no directory is specified, the subdirectory with the specified name is deleted in the default directory.

**Setting parameters:**

<Directory>                    string  
String parameter to specify the directory to be deleted.

**Example:**                    See [Example "Working with files and directories"](#) on page 908.

**Usage:**                        Setting only

---

**:MMEMory:RDIRectory:RECURSive** <Directory>

Removes the specified directory, including files and subdirectories from the mass memory storage system. If no directory is specified, the command removes the subdirectories of the default directory.

The command the entire directory without further prompt or notification.

**Setting parameters:**

<Directory>                    string  
String parameter to specify the directory to be deleted.

**Example:**                    See [Example "Working with files and directories"](#) on page 908.

**Usage:**                        Setting only

---

**:MMEMory:STORE:STATe** <savrcl\_state\_nr>, <file\_name>

Stores the current instrument setting in the specified file.

The instrument setting must first be stored in an internal memory with the same number using the common command \*SAV.

**Setting parameters:**

<savrcl\_state\_nr>            Corresponds to the specific <number> defined with the \*SAV command, e.g. \*SAV 4.

<file\_name>                    String parameter to specify the file name with extension \*.savrcltxt.

**Example:**                    See [Example "Saving and loading current settings"](#) on page 907.

**Usage:**                        Event

**Manual operation:**        See ["Save"](#) on page 711

**:MEMory:HFRee?**

Returns the used and available memory in Kb.

**Return values:**

<TotalPhysMemKb>	integer	Total physical memory.
<ApplicMemKb>	integer	Application memory.
<HeapUsedKb>	integer	Used heap memory.
<HeapAvailableKb>	integer	Available heap memory.

**Usage:** Query only

## 14.8 CALibration subsystem

The CALibration subsystem contains the commands needed for performing internal adjustments. This procedure is triggered by the query commands.

**Common suffixes**

The following common suffixes are used in the remote commands:

Suffix	Value range	Description
CALibration<hw>	[1] to 2	<ul style="list-style-type: none"> <li>CALibration[1] = Path A (optional suffix)</li> <li>CALibration2 = Path B (mandatory suffix)</li> </ul>

**Understanding the query response**

- 0: error-free execution of the adjustments
- 1: indicates that an error occurred; the process has been canceled

**Example: Querying the most recent internal adjustments**

```

CALibration:ALL:DATE?
"2024-07-16"
CALibration:ALL:INformation?
"" // no adjustment info available
CALibration:ALL:TEMP?
"-2.0 K"
CALibration:ALL:TIME?
"17 days"

```

:CALibration:ALL[:MEASure]?	918
:CALibration<hw>:ALL:DATE?	918
:CALibration<hw>:ALL:INformation?	919
:CALibration<hw>:ALL:TEMP?	919
:CALibration<hw>:ALL:TIME?	919
:CALibration<hw>:CONTinueonerror	919
:CALibration:DATA:EXPort	920
:CALibration:DATA:FACTory:DATE?	920
:CALibration:DElay:MINutes	920
:CALibration:DElay:SHUTdown[:STATe]	920
:CALibration:DElay[:MEASure]?	921
:CALibration<hw>:DEBUg	921
:CALibration<hw>:IQModulator:LOCAl?	921
:CALibration<hw>:FREQUency:CONVerter:EXTernal?	922
:CALibration<hw>:LOSCillator:COUPling:LOCAl?	922

---

### :CALibration:ALL[:MEASure]?? [<Force>]

Starts all internal adjustments that do not need external measuring equipment.

**Note:** If an external frequency converter R&S SZU is connected, the internal adjustments are blocked, and the R&S SMW200A generates an error message.

#### Query parameters:

<Force>                    string

#### Return values:

<Measure>                1 | ON | 0 | OFF

#### Example:

```
CAL:ALL:MEAS?
// Response: "0"
// Executes the adjustments of all instrument functions.
// When completed, it indicates that the adjustment
// has been performed successfully.
```

**Usage:**                    Query only

**Manual operation:**    See "[Adjust All](#)" on page 1368

---

### :CALibration<hw>:ALL:DATE?

Queries the date of the most recently executed full adjustment.

#### Return values:

<Date>                    string

**Example:**                See [Example "Querying the most recent internal adjustments"](#) on page 917.

**Usage:**                    Query only

**Manual operation:**    See "[Last Full Adjustment](#)" on page 1368

---

**:CALibration<hw>:ALL:INFormation?**

Queries the current state of the internal adjustment.

**Return values:**

<CallInfoText>      string

**Example:**            See [Example "Querying the most recent internal adjustments"](#) on page 917.

**Usage:**                Query only

**Manual operation:**   See ["Information"](#) on page 1369

---

**:CALibration<hw>:ALL:TEMP?**

Queries the temperature deviation compared to the calibration temperature.

**Return values:**

<Temperature>      string

**Example:**            See [Example "Querying the most recent internal adjustments"](#) on page 917.

**Usage:**                Query only

**Manual operation:**   See ["Temperature Offset"](#) on page 1369

---

**:CALibration<hw>:ALL:TIME?**

Queries the time elapsed since the last full adjustment.

**Return values:**

<Time>                string

**Example:**            See [Example "Querying the most recent internal adjustments"](#) on page 917.

**Usage:**                Query only

**Manual operation:**   See ["Time"](#) on page 1369

---

**:CALibration<hw>:CONTinueonerror <State>**

Continues the calibration even though an error was detected. By default adjustments are aborted on error.

**Parameters:**

<State>                1 | ON | 0 | OFF

\*RST:                n.a. (factory preset: 0)

**Example:**            `CAL:CONT ON`  
                          // Continues calibration after an error

**Manual operation:**   See ["Continue Adjustment on Error"](#) on page 1370

---

---

**:CALibration:DATA:EXPort**

Collects the internal adjustment data and provides the data for export in a zip file. You can export the data for service and evaluation purposes.

**Example:** `:CALibration:DATA:EXPort`

**Usage:** Event

---

**:CALibration:DATA:FACTory:DATE?**

Queries the date of the last factory calibration.

**Return values:**

<Date> string

**Example:** `CAL:DATA:FACT:DATE?`  
`// "2016-01-01"`

**Usage:** Query only

**Manual operation:** See "[Last Factory Calibration](#)" on page 1351

---

**:CALibration:DELAy:MINutes <Minutes>**

Sets the warm-up time to wait before internal adjustment starts automatically.

Automatic execution starts only, if you have enabled the calibration with command :  
[CALibration:DELAy\[:MEASure\]? ON](#).

**Parameters:**

<Minutes> integer

Range: 30 to 120

\*RST: n.a. (no preset. default: 60)

**Example:** `:CALibration:DELAy:MINutes 30`  
`// sets the time delay for warm-up of the instrument.`

**Manual operation:** See "[Warm Up Time](#)" on page 1371

---

**:CALibration:DELAy:SHUTdown[:STATe] <Shutdown>**

Enables the instrument to shut down automatically after calibration.

**Parameters:**

<Shutdown> 1 | ON | 0 | OFF

\*RST: 0

**Example:** `:CALibration:DELAy:SHUTdown[:STATe] ON|1`  
`// inititates that the instrument shuts down when the adjustments are com`

**Manual operation:** See "[Shutdown After Adjustment](#)" on page 1371



**:CALibration:DElay[:MEASure]?**

Starts the delayed adjustment process. When the warm-up time has elapsed (see :CALibration:DElay:MINutes, it executes the internal adjustments.

If you have enabled automatic shutdown, :CALibration:DElay:SHUTdown[:STATe] ON, the instrument shuts down when the adjustments are completed.

**Return values:**

<Error> 1 | ON | 0 | OFF  
 \*RST: n.a. (no preset. default: 0)

**Example:**

```
:CALibration:DElay[:MEASure] ON|1
// enables the adjustment processs to start after the warm-up time automa
```

**Usage:** Query only

**Manual operation:** See "[Adjust All Delayed](#)" on page 1370

**:CALibration<hw>:DEBug <State>**

Activates logging of the internal adjustments.

**Setting parameters:**

<State> 0 | 1 | OFF | ON  
 \*RST: 0

**Example:**

```
CALibration:DEBug 1
```

**Usage:** Setting only

**Manual operation:** See "[Log Debug Info](#)" on page 1370

**:CALibration<hw>:IQModulator:LOCal?**

Starts adjustment of the I/Q modulator for the currently set frequency and baseband gain. The I/Q modulator is adjusted with respect to carrier leakage, I/Q imbalance and quadrature.

**Return values:**

<Local> 1 | ON | 0 | OFF  
 \*RST: 0

**Example:**

```
// Start adjustment for the I/Q modulator
// for the currently set frequency
CALibration:IQModulator:LOCal?
// 0
// Adjustments are performed successfully
```

**Usage:** Query only

**Manual operation:** See "[Adjust I/Q Modulator Current Frequency](#)" on page 1369

**:CALibration<hw>:FREQuency:CONVerter:EXTernal?**

Queries the calibration state of the connected external instrument.

External instrument can be for example an external frontend.

**Return values:**

<Success> 1 | ON | 0 | OFF  
\*RST: 0

**Example:**

```
// Query calibration state of a connected external frontend.
CAL1:FREQ:CONV:EXT?
// 1
// The external frontend connected in path A is calibrated.
```

**Usage:** Query only

**Manual operation:** See "[Adjust External Frequency Converter](#)" on page 1369

**:CALibration<hw>:LOSCillator:COUPling:LOCal?**

Adjusts the internal LO level at the I/Q modulator automatically, when an external LO signal is fed.

**Return values:**

<CouplingLevel> 1 | ON | 0 | OFF  
\*RST: 1

**Example:**

```
CALibration:LOSCillator:COUPling:LOCal 1
```

**Usage:** Query only

**Manual operation:** See "[Adjust LO Level at Current Frequency](#)" on page 504

## 14.9 CLOCK subsystem

The CLOCK subsystem contains the commands for configuration of the signals at the clock input and output connectors.

**:CLOCK:INPut:FREQuency?**

Returns the measured frequency of the external clock signal.

**Return values:**

<Frequency> float  
Range: 0 to max  
Increment: 0.001  
\*RST: 0

**Example:**

```
:CLOCK:INPut:FREQuency?
```

**Usage:** Query only

**Options:** R&S SMW-B10

**Manual operation:** See "Measured External Clock" on page 261

## 14.10 DIAGnostic subsystem

The `DIAGnostic` subsystem contains the commands used for instrument diagnosis and servicing. SCPI does not define any `DIAGnostic` commands; the commands listed here are all device-specific. All `DIAGnostic` commands are query commands which are not affected by `*RST`.



The test functions are intended for services purposes.

They are thus password-protected functions. Unlock the corresponding protection level to access them, see `:SYSTem:PROTect<ch>[:STATe]`.

For more information, see R&S SMW200A Service Manual.

### Common suffixes

The following common suffixes are used in remote commands:

Suffix	Value range	Description
<code>DIAGnostic&lt;hw&gt;</code>	[1]   2	Signal path

### Example: Programming example

The example lists the commands required to query assemblies and test points for diagnosis purposes.

```
// Query the modules available in the instrument
// and variant and revision state of a certain assembly
DIAGnostic1:BGInfo:CATalog?
// IEC_BOARD,BNC_BOARD,BMB,FPNL,SSYN,SYNEX,RFMB,...
DIAGnostic1:BGInfo? "SSYN"
// SSYN 1412.6667.02 05.02 100000

// Query the test points available in the instrument
// and trigger the measurement in a selected test point
DIAGnostic1:POINt:CATalog?
// ASATT6HP_M5V7,ASATT6HP_OFFSET,...
DIAGnostic1:MEASure:POINt? "BBB_CODER_BBB_US"
// -1.000000V/°C

// Query the operating hours and number of power-on so far.
DIAGnostic:INFO:OTIME?
// 112 h
DIAGnostic:INFO:POCount?
// 14
```

**Commands**

:DIAGnostic<hw>:BGInfo:CATalog?	924
:DIAGnostic<hw>:BGInfo?	924
:DIAGnostic:INFO:OTIME?	924
:DIAGnostic:INFO:POCount?	925
:DIAGnostic<hw>:POINt:CATalog?	925
:DIAGnostic<hw>[:MEASure]:POINt?	925

**:DIAGnostic<hw>:BGInfo:CATalog?**

Queries the names of the assemblies available in the instrument.

**Return values:**

<Catalog>                      string  
 List of all assemblies; the values are separated by commas  
 The length of the list is variable and depends on the instrument  
 equipment configuration.

**Example:**                      See [Example "Programming example"](#) on page 923.

**Usage:**                              Query only

**:DIAGnostic<hw>:BGInfo? [<Board>]**

Queries information on the modules available in the instrument, using the variant and revision state.

**Query parameters:**

<Board>                              string  
 Module name, as queried with the command :  
[DIAGnostic<hw>:BGInfo:CATalog?](#)  
 To retrieve a complete list of all modules, omit the parameter.  
 The length of the list is variable and depends on the instrument  
 equipment configuration.

**Return values:**

<BgInfo>                              <Module name> <Module stock number incl. variant> <Module  
 revision> <Module serial number>  
 List of comma-separated entries, one entry per module.  
 Each entry for one module consists of four parts that are separa-  
 ted by space characters.

**Example:**                              See [Example "Programming example"](#) on page 923.

**Usage:**                              Query only

**Manual operation:**      See ["Assembly"](#) on page 1350

**:DIAGnostic:INFO:OTIME?**

Queries the operating hours of the instrument so far.

**Return values:**

<OperationTime> integer  
 Range: 0 to INT\_MAX  
 \*RST: 0

**Example:** See [Example "Programming example"](#) on page 923.

**Usage:** Query only

**Manual operation:** See ["Operation Time / h"](#) on page 1351

**:DIAGnostic:INFO:POCount?**

Queries how often the instrument has been turned on so far.

**Return values:**

<PowerOnCount> integer  
 Range: 0 to INT\_MAX  
 \*RST: 0

**Example:** See [Example "Programming example"](#) on page 923.

**Usage:** Query only

**Manual operation:** See ["Power On Count"](#) on page 1351

**:DIAGnostic<hw>:POINT:CATalog?**

Queries the test points available in the instrument.

For more information, see R&S SMW200A Service Manual.

**Return values:**

<Catalog> string  
 List of comma-separated values, each representing a test point

**Example:** See [Example "Programming example"](#) on page 923.

**Usage:** Query only

**:DIAGnostic<hw>[:MEASure]:POINT? <Name>**

Triggers the voltage measurement at the specified test point and returns the measured voltage.

For more information, see R&S SMW200A Service Manual.

**Query parameters:**

<Name> <test point identifier>  
 Test point name, as queried with the command :  
[DIAGnostic<hw>:POINT:CATalog?](#)

**Return values:**

<Value> <value><unit>

**Example:** See [Example "Programming example"](#) on page 923.  
**Usage:** Query only

## 14.11 HUMS remote control commands

The remote control commands for the health and utilizations monitoring system (HUMS) comprise commands of the `DIAGnostic` subsystem and the commands of the `SYSTEM:COMMunicate:REST` and `SYSTEM:COMMunicate:REST` subsystems.

For all HUMS-related remote control commands, see refer to the "R&S®HUMS Health and Utilization Monitoring Service" User Manual on the Internet.

### Commands

<a href="#">DIAGnostic:HUMS:DELeTe:ALL</a> .....	926
<a href="#">DIAGnostic:HUMS:DEVice:HISTory?</a> .....	927
<a href="#">DIAGnostic:HUMS:DEVice:HISTory:DELeTe:ALL</a> .....	927
<a href="#">DIAGnostic:HUMS:FORMat</a> .....	928
<a href="#">DIAGnostic:HUMS:SAVE</a> .....	928
<a href="#">DIAGnostic:HUMS:STATe</a> .....	928
<a href="#">DIAGnostic:HUMS:TAGS:ALL?</a> .....	928
<a href="#">DIAGnostic:HUMS:TAGS:DELeTe</a> .....	929
<a href="#">DIAGnostic:HUMS:TAGS:DELeTe:ALL</a> .....	929
<a href="#">DIAGnostic:HUMS:TAGS[:VALue]</a> .....	929
<a href="#">SYSTEM:COMMunicate:REST:ENABle</a> .....	930
<a href="#">SYSTEM:COMMunicate:SNMP:COMMunity:RO</a> .....	930
<a href="#">SYSTEM:COMMunicate:SNMP:COMMunity:RW</a> .....	930
<a href="#">SYSTEM:COMMunicate:SNMP:CONtact</a> .....	931
<a href="#">SYSTEM:COMMunicate:SNMP:LOCation</a> .....	931
<a href="#">SYSTEM:COMMunicate:SNMP:USM:USER</a> .....	931
<a href="#">SYSTEM:COMMunicate:SNMP:USM:USER:ALL?</a> .....	932
<a href="#">SYSTEM:COMMunicate:SNMP:USM:USER:DELeTe</a> .....	932
<a href="#">SYSTEM:COMMunicate:SNMP:USM:USER:DELeTe:ALL</a> .....	932
<a href="#">SYSTEM:COMMunicate:SNMP:VERSion</a> .....	933

---

### **DIAGnostic:HUMS:DELeTe:ALL**

Deletes the complete HUMS data. This includes device history, device tags, SCPI connections, utilization history and utilizations.

**Example:** `//Delete HUMS data`  
`DIAG:HUMS:DEL:ALL`

**Usage:** Event

**DIAGnostic:HUMS:DEvice:HISTory?**

Queries the device history information of the connected instrument. Depending on the set data format, the queried data is either displayed in XML or JSON format. For more information about setting the data format, see [DIAGnostic:HUMS:FORMat](#) on page 928.

**Return values:**

<HistoryInfo>                    <block\_data>  
 Device history information of the connected instrument as block data in a comma-separated list:  
 #blockdata[{event1},{event2},{event3}...]  
 With the following parameters:  
 <eventID>,<eventTimestamp>,<eventMessage>,<eventDetails>,<eventSeverity>  
 Binary block data with the following syntax:  
 #<Digits><Length><Binarydata>  
 #  
 Indicates the start of the binary block  
 <Digits>  
 Decimal value  
 Gives the number of decimal digits used for the <Length> value  
 <Length>  
 Decimal value  
 Number of bytes the follow in the <Binary data> part  
 <Binary data>  
 Binary data in ASCII format

**Example:**

```
//Return device history
DIAG:HUMS:DEV:HIST?
Returns for example:
#44715[{"eventId":32,"eventTimestamp":
"2021-02-02T17:25:39Z","eventMessage":
"Deviation from Self Alignment Temperature",
"eventDetails":
"Deviations resolved","eventSeverity":0}
```

**Usage:**                    Query only

**Manual operation:**    See "[Export History](#)" on page 842

**DIAGnostic:HUMS:DEvice:HISTory:DElete:ALL**

Deletes the complete device history information of the connected instrument.

**Example:**                    //Delete complete device history  
 DIAG:HUMS:DEV:HIST:DEL:ALL

**Usage:**                    Event

**Manual operation:**    See "[Delete History](#)" on page 842

---

**DIAGnostic:HUMS:FORMat** <DataFormat>

Selects the format for the queried HUMS data. You can query the HUMS data either in `JSON` format or `XML` format.

The defined format affects all other commands that return block data.

**Parameters:**

<DataFormat>      `JSON | XML`  
**JSON**  
 Returns the HUMS data in `JSON` format.  
**XML**  
 Returns the HUMS data in `XML` format.  
 \*RST:            `JSON`

**Example:**

```
//Return data in JSON format
DIAG:HUMS:FORM JSON
```

---

**DIAGnostic:HUMS:SAVE** <path>

Saves the HUMS history as a `ZIP` file to your preferred path.

**Setting parameters:**

<path>

**Example:**

```
//Save HUMS history data
DIAG:HUMS:SAVE 'C:\HUMS\hums_2021.zip'
```

**Usage:**

Setting only

**Manual operation:** See "[Export History](#)" on page 842

---

**DIAGnostic:HUMS:STATe** <State>

Turns the HUMS service and data collection on and off.

**Parameters:**

<State>            `ON | OFF | 1 | 0`  
 \*RST:            `ON`

**Example:**

```
//Turn on HUMS service
DIAG:HUMS:STAT ON
```

**Manual operation:** See "[State](#)" on page 842

---

**DIAGnostic:HUMS:TAgS:ALL?**

Queries all key-value tags that you have assigned to the instrument. Depending on the set data format, the queried data is either displayed in `XML` or `JSON` format. For more information about setting the data format, see [DIAGnostic:HUMS:FORMat](#) on page 928.



**Return values:**

<ID>	ID number of the defined tag.
<Key>	String containing key name of the defined tag.
<Value>	String containing value of the defined tag.

**Example:** //Return all tags  
 DIAG:HUMS:TAGS:ALL?  
 1,"location","building\_11",2,"time zone","CET"

**Usage:** Query only

**Manual operation:** See ["Add"](#) on page 851

**DIAGnostic:HUMS:TAGS:DELeTe <ID>**

Deletes a certain tag you assigned to your instrument, including its key and value.

**Setting parameters:**

<ID>	ID number of the tag you want to delete. To identify the ID number, query all device tags from the system first. For more information, see <a href="#">DIAGnostic:HUMS:TAGS:ALL?</a> on page 928.
------	--

**Example:** //Delete tag  
 DIAG:HUMS:TAGS:DEL 0

**Usage:** Setting only

**Manual operation:** See ["Delete"](#) on page 850

**DIAGnostic:HUMS:TAGS:DELeTe:ALL**

Deletes all key-value tags you have assigned to the instrument.

**Example:** //Delete all tags  
 DIAG:HUMS:TAGS:DEL:ALL

**Usage:** Event

**Manual operation:** See ["Delete All"](#) on page 851

**DIAGnostic:HUMS:TAGS[:VALue] <ID>, <Key>, <Value>****DIAGnostic:HUMS:TAGS[:VALue]? <ID>**

Adds or modifies a key-value pair (device tag).

The query returns the key-value pair for a given ID or an empty string if the ID is unknown.

**Parameters:**

<Key>	String containing key name of the queried tag.
<Value>	String containing value of the queried tag.

**Parameters for setting and query:**

<ID> 0 - 31  
 ID number of the tag you want to modify or query.  
 To identify the ID number, query all device tags from the system first. For more information, read here [DIAGnostic:HUMS:TAGS:ALL?](#) on page 928.

**Example:** //Add or modify a tag (tag 1)  
 DIAG:HUMS:TAGS 1, 'location', 'building\_11'

**Manual operation:** See "[Key](#)" on page 850  
 See "[Value](#)" on page 850  
 See "[Add](#)" on page 851

**SYSTem:COMMunicate:REST:ENABLE <RestState>**

Turns communication via the REST API on and off.

**Parameters:**

<RestState> ON | OFF | 0 | 1

**Example:** //Return REST state  
 SYST:COMM:REST:ENAB?

**Manual operation:** See "[REST](#)" on page 844

**SYSTem:COMMunicate:SNMP:COMMunity:RO <CommunityString>**

Defines the SNMP community string for read-only access.

Prerequisites for this command:

- Select an SNMP version that supports communities ([SYSTem:COMMunicate:SNMP:VERSion](#) on page 933).

**Setting parameters:**

<CommunityString> String containing the community name.

**Example:** //Set community name  
 SYST:COMM:SNMP:VERS V12  
 SYST:COMM:SNMP:COMM:RO 'ABC'

**Usage:** Setting only

**Manual operation:** See "[Access](#)" on page 845

**SYSTem:COMMunicate:SNMP:COMMunity:RW <CommunityString>**

Defines the SNMP community string for read-write access.

Prerequisites for this command:

- Select an SNMP version that supports communities ([SYSTem:COMMunicate:SNMP:VERSion](#) on page 933).

**Setting parameters:**

<CommunityString> String containing the community name.

**Example:** //Set read-write access  
 SYST:COMM:SNMP:VERS V12  
 SYST:COMM:SNMP:COMM:RW 'ABC'

**Usage:** Setting only

**Manual operation:** See ["Access"](#) on page 845

**SYSTem:COMMunicate:SNMP:CONtact** <SnmContact>

Defines the SNMP contact information for the administrator.

You can also set the contact information via SNMP if you do not set it via SCPI.

**Parameters for setting and query:**

<SnmContact> String containing SNMP contact.  
 \*RST: "" (empty string)

**Example:** //Set SNMP contact  
 SYST:COMM:SNMP:CONT 'ABC'

**Manual operation:** See ["Contact"](#) on page 845

**SYSTem:COMMunicate:SNMP:LOCation** <SnmLocation>

Defines the SNMP location information for the administrator.

You can also set the location information via SNMP if you do not set it via SCPI.

**Parameters for setting and query:**

<SnmLocation> String containing SNMP location.  
 \*RST: "" (empty string)

**Example:** //Return SNMP location  
 SYST:COMM:SNMP:LOC?

**Manual operation:** See ["Location"](#) on page 844

**SYSTem:COMMunicate:SNMP:USM:USER** <Name>, <Access>, <Level>[, <Auth\_pwd>[, <Priv\_pwd>]]

Defines an SNMP user profile.

Prerequisites for this command:

- Select SNMPv3 ([SYSTem:COMMunicate:SNMP:VERSion](#) on page 933).

**Setting parameters:**

<Name> String containing name of the user.

<Access> RO | RW  
 Defines the access right a user can have.

<Level>	NOAuth   AUTH   PRIVacy Defines the security level.
<Auth_pwd>	String containing the authentication password.
<Priv_pwd>	String containing the privacy password.
<b>Example:</b>	//Create user profile SYST:COMM:SNMP:VERS V123 SYST:COMM:SNMP:USM:USER 'Peter','RO','PRIV', '1234','XYZ'
<b>Usage:</b>	Setting only
<b>Manual operation:</b>	See <a href="#">"Add SNMP User for HUMS"</a> on page 848

**SYSTem:COMMunicate:SNMP:USM:USER:ALL?**

Queries the number of users and a list of all SNMP users for SNMPv3.

Prerequisites for this command:

- Select SNMPv3 ([SYSTem:COMMunicate:SNMP:VERSion](#) on page 933).

**Return values:**

<Count>	Total number of registered SNMP users.
<Name>	List of all user names as a comma-separated list.

**Example:** //Return all SNMP users  
SYST:COMM:SNMP:USM:USER:ALL?

**Usage:** Query only

**Manual operation:** See ["User table"](#) on page 847

**SYSTem:COMMunicate:SNMP:USM:USER:DELeTe <UserName>**

Deletes a specific SNMP user profile.

**Setting parameters:**

<UserName>	String containing name of SNMP user profile to be deleted.
------------	--

**Example:** //Delete SNMP user profile  
SYST:COMM:SNMP:USM:USER:DEL "Peter"

**Usage:** Setting only

**Manual operation:** See ["Delete"](#) on page 848

**SYSTem:COMMunicate:SNMP:USM:USER:DELeTe:ALL**

Deletes all SNMP user profiles.

**Example:** //Delete all SNMP user profiles  
SYST:COMM:SNMP:USM:USER:DEL:ALL

**Usage:** Event

**Manual operation:** See "[Delete All](#)" on page 846

---

### SYSTem:COMMunicate:SNMP:VERSion <SnmVersion>

Selects the SNMP version.

#### Parameters for setting and query:

<SnmVersion> OFF | V12 | V123 | V3 | DEFault

#### OFF

SNMP communication is off.

#### V12

SNMP communication with SNMPv2 or lower.

#### V123

SNMP communication with SNMPv2 and SNMPv3.

#### V3

SNMP communication with SNMPv3.

\*RST: V123

**Example:** //Select the SNMP version  
SYST:COMM:SNMP:VERS V12

**Manual operation:** See "[SNMP](#)" on page 844

## 14.12 DISPlay subsystem

The DISPlay system contains the commands to set the power-save mode of the instrument.

### Programming Examples

#### Example: Activating screen saver mode and display update

Use the following commands to switch on the screen saver of your instrument or to automatic display. These settings are particularly useful when you control the instrument remotely.

```
// Set the wait time interval and activate the screen saver
DISPlay:PSAVe:HOLDoff 10
DISPlay:PSAVe:STATe ON
```

```
// Disable the display of the current frequency and level values in remote control
DISPlay:ANNotation:ALL "<password>", ON
// DISPlay:ANNotation:FREQuency "<password>", ON
// DISPlay:ANNotation:AMPLitude "<password>", ON
```

```
// Enable automatic update of the display at defined time intervals
DISPlay:UPDate[:STATe] ON
```

**Example: Querying the dialog IDs, opening and closing dialogs**

Use the following commands to query the dialog IDs of all currently open dialogs. The dialog ID is a prerequisite for opening and closing dialogs via the remote control.



The dialog ID is also required to define user key actions.

See [Section 12.4.2, "How to assign actions to the \[USER\] key"](#), on page 767.

```
// Query the dialog IDs of all open dialogs
DISPlay:DIALog:ID?
// CEUltraDLGenSetDlg,_, $A DlgKeyRf_Rosc
```

```
// Open and close dialogs via remote control
DISPlay:DIALog:OPEN "CEUltraDLGenSetDlg,_, $A"
DISPlay:DIALog:OPEN "DlgKeyRf_Rosc"
DISPlay:DIALog:CLOSe "DlgKeyRf_Rosc"
DISPlay:DIALog:CLOSe:ALL
```

:DISPlay:PSAVe:HOLDoff.....	934
:DISPlay:PSAVe[:STATe].....	934
:DISPlay:UPDate[:STATe].....	935
:DISPlay:ANNotation:AMPLitude.....	935
:DISPlay:ANNotation:FREQuency.....	935
:DISPlay:ANNotation[:ALL].....	936
:DISPlay:DIALog:ID?.....	936
:DISPlay:DIALog:OPEN.....	937
:DISPlay:DIALog:CLOSe.....	937
:DISPlay:DIALog:CLOSe:ALL.....	937

**:DISPlay:PSAVe:HOLDoff** <HoldoffTimeMin>

Sets the wait time for the screen saver mode of the display.

**Parameters:**

<HoldoffTimeMin> integer  
 Range: 1 to 60  
 \*RST: n.a. (factory preset: 10)  
 Default unit: minute

**Example:** see [Example "Activating screen saver mode and display update"](#) on page 933

**Manual operation:** See ["Wait Time"](#) on page 738

**:DISPlay:PSAVe[:STATe]** <State>

Activates the screen saver mode of the display.

We recommend that you use this mode to protect the display, if you operate the instrument in remote control.

To define the wait time, use the command `:DISPlay:PSAVe:HOLDoff`.

**Parameters:**

<State> 1 | ON | 0 | OFF  
 \*RST: n.a. (factory preset: 0)

**Example:** See [Example "Activating screen saver mode and display update"](#) on page 933

**Manual operation:** See ["Screen Saver"](#) on page 738

**:DISPlay:UPDate[:STATE] <Update>**

Activates the refresh mode of the display.

**Parameters:**

<Update> 1 | ON | 0 | OFF  
 \*RST: n.a. (factory preset: 1)

**Example:** See [Example "Activating screen saver mode and display update"](#) on page 933

**Manual operation:** See ["Display Update is"](#) on page 740

**:DISPlay:ANNOtation:AMPLitude <SecPassword>, <State>**

Indicates asterisks instead of the level values in the status bar.

**Parameters:**

<SecPassword> string  
 <State> 1 | ON | 0 | OFF  
 \*RST: n.a. (factory preset: 1)

**Example:** See [Example "Activating screen saver mode and display update"](#) on page 933

**Manual operation:** See ["Annotation Amplitude"](#) on page 798

**:DISPlay:ANNOtation:FREQuency <SecPassWord>, <State>**

Indicates asterisks instead of the frequency values in the status bar.

**Parameters:**

<SecPassWord> string  
 <State> 1 | ON | 0 | OFF  
 \*RST: n.a. (factory preset: 1)

**Example:** See [Example "Activating screen saver mode and display update"](#) on page 933

**Manual operation:** See ["Annotation Frequency"](#) on page 798

---

**:DISPlay:ANNOtation[:ALL] <SecPassword>, <State>**

Displays asterisks instead of the level and frequency values in the status bar of the instrument.

We recommend that you use this mode if you operate the instrument in remote control.

**Parameters:**

<SecPassword>      string

<State>              1 | ON | 0 | OFF

\*RST:                1

**Example:**            See [Example "Activating screen saver mode and display update"](#) on page 933

---

**:DISPlay:DIALog:ID?**

Returns the dialog identifiers of the open dialogs in a string separated by blanks.

**Return values:**

<DialogIdList>      <DialogID#1>< ><DialogID#2>< > ... < ><DialogID#n>

Dialog identifiers are string without blanks. Blanks are represented as \$\$.

Dialog identifiers <DialogID> are composed of two main parts:

<DialogName>[<OptionalParts>]

**<DialogName>**

Meaningful information, mandatory input parameter for the commands:

[:DISPlay:DIALog:OPEN](#) on page 937

[:DISPlay:DIALog:CLOSe](#) on page 937

**<Optional parts>**

String of \$<X> values, where <X> is a character, interpreted as follows:

\$q<DialogQualifier>: optional dialog qualifier, usually the letter A or B, as displayed in the dialog title.

\$i<Instances>: comma-separated list of instance indexes, given in the order h, c, s, d, g, u, 0. Default is zero; the terminating ", 0" can be omitted.

\$t<TabIds>: comma-separated indexes or tab names; required, if a dialog is composed of several tabs.

\$x<Left>\$y<Top>\$h<Left>\$w<Top>: position and size; superfluous information.

**Example:**            See [Example "Querying the dialog IDs, opening and closing dialogs"](#) on page 934

**Usage:**                Query only

**Manual operation:** See ["SCPI"](#) on page 770



---

**:DISPlay:DIALog:OPEN** <DialogId>

Opens the specified dialog.

**Setting parameters:**

<DialogId>                    string  
To find out the dialog identifier, use the query `:DISPlay:DIALog:ID?`.  
The <DialogName> part of the query result is mandatory.

**Example:**                    See [Example "Querying the dialog IDs, opening and closing dialogs"](#) on page 934

**Usage:**                      Setting only

**Manual operation:**    See ["SCPI"](#) on page 770

---

**:DISPlay:DIALog:CLOSE** <DialogId>

Closes the specified dialog.

**Setting parameters:**

<DialogId>                    string  
To find out the dialog identifier, use the query `:DISPlay:DIALog:ID?`.  
The <DialogName> part of the query result is sufficient.

**Example:**                    See [Example "Querying the dialog IDs, opening and closing dialogs"](#) on page 934

**Usage:**                      Setting only

---

**:DISPlay:DIALog:CLOSE:ALL**

Closes all open dialogs.

**Example:**                    See [Example "Querying the dialog IDs, opening and closing dialogs"](#) on page 934

**Usage:**                      Event

---

## 14.13 FORMat subsystem

The commands in the FORMat subsystem determine the format of data returned by the R&S SMW200A to the controller. This affects all query commands that return a list of numerical data or block data, noted in the descriptions of the commands. The set data format applies to both paths.

<a href="#">:FORMat:BORDER</a> .....	938
<a href="#">:FORMat:SREGister</a> .....	938
<a href="#">:FORMat[DATA]</a> .....	938

---

**:FORMat:BORDER** <Border>

Determines the sequence of bytes within a binary block. This only affects blocks which use the IEEE754 format internally.

**Parameters:**

<Border>                    NORMal | SWAPped

**NORMal**

Expects/sends the *least* significant byte of each IEEE754 floating-point number first and the *most* significant byte last.

**SWAPped**

Expects/sends the *most* significant byte of each IEEE754 floating-point number first and the *least* significant byte last.

\*RST:                    NORMal

**Example:**

:FORM:BORD SWAP

transfers the data with the most significant bit first.

---

**:FORMat:SREGister** <Format>

Determines the numeric format for responses of the status register.

**Parameters:**

<Format>                    ASCii | BINary | HEXadecimal | OCTal

**ASCii**

Returns the register content as a decimal number.

**BINary|HEXadecimal|OCTal**

Returns the register content either as a binary, hexadecimal or octal number. According to the selected format, the number starts with #B (binary), #H (hexadecimal) or #O (octal).

\*RST:                    ASCii

**Example:**

:FORM:SREG HEX

returns the register content as a hexadecimal number.

---

**:FORMat[:DATA]** <Data>

Determines the data format the instrument uses to return data via the IEC/IEEE bus.

The instrument automatically detects the data format used by the controller, and assigns it accordingly. Data format determined by this SCPI command is in this case irrelevant.

**Parameters:**

<Data>                    ASCii | PACKed

**ASCii**

Transfers numerical data as plain text separated by commas.

**PACKed**

Transfers numerical data as binary block data.

The format within the binary data depends on the command.

The various binary data formats are explained in the description of the parameter types.

\*RST:        ASCii

**Example:**

:FORM ASC

transfers the data as ASCII data.

## 14.14 HCOpy subsystem

The HCOpy subsystem contains the commands to generate and save a hard copy of the display.



To access a stored hard copy file, use the commands of the MEMM subsystem.

**Example: Store a hard copy of the display**

The following example lists commands to configure and execute a hard copy to an automatic named file.

```
:HCOpy:DEVIce:LANGUage PNG
:HCOpy:FILE:NAME:AUTO:STATe 1
// defines the output format
// sets the instrument to automatically create output file names

// *****
// Configure hard copy options, set automatic naming rules
// An automatically generated file name consists of:
// <Prefix><YYYY><MM><DD><Number>.<Format>
// *****
:HCOpy:DEVIce:LANGUage BMP
// defines output format *.bmp
:HCOpy:REGIon DIALog
// selects the region to be copied
:HCOpy:FILE:AUTO:DIR "/usb/HCopy"
// sets destination directory of automatic named file
:HCOpy:FILE:NAME:AUTO:FILE:PREFix:STATe 1
:HCOpy:FILE:NAME:AUTO:FILE:PREFix:"hardcopy"
:HCOpy:FILE:NAME:AUTO:FILE:YEAR:STATe 1
:HCOpy:FILE:NAME:AUTO:FILE:MONTH:STATe 1
// uses automatic naming prefix
// sets automatic naming prefix to "hardcopy"
// uses automatic naming date parameters year and month

// *****
```

```
// Execute and transfer the hard copy
// *****
:HCOPY:EXECute
:HCOPY:DATA
// generates a hard copy
// transfers the hard copy to the remote client
:HCOPY:FILE:AUTO:FILE?
// queries the automatic file name
// "hardcopy1607001.bmp"
:HCOPY:FILE:AUTO:NUMBer?
// queries the number in the automatic file name
// "001"
:HCOPY:FILE:AUTO?
// queries the path and file name of the automatically generated file
// "/usb/HCopy/hardcopy1607001.bmp"
```

### 14.14.1 Hard copy settings

With the following commands, you can configure the settings of a hard copy.

:HCOPY:DATA?	940
:HCOPY:IMAGe:FORMat	940
:HCOPY:DEVIce:LANGUage	940
:HCOPY:REGIon	941
:HCOPY:FILE[:NAME]	941
:HCOPY[:EXECute]	941

---

#### :HCOPY:DATA?

Transfers the hard copy data directly as a NByte stream to the remote client.

##### Return values:

<Data>                    block data

**Example:**                See [Example "Store a hard copy of the display"](#) on page 939

**Usage:**                    Query only

---

#### :HCOPY:IMAGe:FORMat <Format>

#### :HCOPY:DEVIce:LANGUage <Language>

Selects the graphic format for the hard copy. You can use both commands alternatively.

##### Parameters:

<Language>                BMP | JPG | XPM | PNG

\*RST:                    PNG

**Example:**                See [Example "Store a hard copy of the display"](#) on page 939

**Manual operation:**    See ["Format"](#) on page 732

---

**:HCOPY:REGion** <Region>

Selects the area to be copied.

You can create a snapshot of the screen or an active dialog.

**Parameters:**

<Region>            ALL | DIALog  
\*RST:            ALL

**Example:**            See [Example "Store a hard copy of the display"](#) on page 939

**Manual operation:**    See ["Region"](#) on page 733

---

**:HCOPY:FILE[:NAME]** <Name>

Determines the file name and path to save the hard copy, provided automatic naming is disabled.

**Note:** If you have enabled automatic naming, the instrument automatically generates the file name and directory, see [Section 14.14.2, "Automatic naming"](#), on page 941.

**Parameters:**

<Name>            string

**Example:**            See [Example "Store a hard copy of the display"](#) on page 939

**Manual operation:**    See ["File..."](#) on page 732

---

**:HCOPY[:EXECute]**

Generates a hard copy of the current display. The output destination is a file.

**Example:**            See [Example "Store a hard copy of the display"](#) on page 939

**Usage:**            Event

**Manual operation:**    See ["Save"](#) on page 732

---

## 14.14.2 Automatic naming

Use the following commands to automatically assign a file name.

<a href="#">:HCOPY:FILE[:NAME]:AUTO?</a> .....	942
<a href="#">:HCOPY:FILE[:NAME]:AUTO:DIRectory</a> .....	942
<a href="#">:HCOPY:FILE[:NAME]:AUTO:DIRectory:CLEar</a> .....	942
<a href="#">:HCOPY:FILE[:NAME]:AUTO:FILE?</a> .....	942
<a href="#">:HCOPY:FILE[:NAME]:AUTO:STATe</a> .....	943
<a href="#">:HCOPY:FILE[:NAME]:AUTO[:FILE]:DAY:STATe</a> .....	943
<a href="#">:HCOPY:FILE[:NAME]:AUTO[:FILE]:MONTH:STATe</a> .....	943
<a href="#">:HCOPY:FILE[:NAME]:AUTO[:FILE]:YEAR:STATe</a> .....	943
<a href="#">:HCOPY:FILE[:NAME]:AUTO[:FILE]:NUMBer?</a> .....	943
<a href="#">:HCOPY:FILE[:NAME]:AUTO[:FILE]:PREFix</a> .....	944
<a href="#">:HCOPY:FILE[:NAME]:AUTO[:FILE]:PREFix:STATe</a> .....	944

---

**:HCOPY:FILE[:NAME]:AUTO?**

Queries path and file name of the hardcopy file, if you have enabled *Automatic Naming*.

**Return values:**

<Auto> string

**Example:** See [Example "Store a hard copy of the display"](#) on page 939

**Usage:** Query only

---

**:HCOPY:FILE[:NAME]:AUTO:DIRectory <Directory>**

Determines the path to save the hard copy, if you have enabled *Automatic Naming*.

If the directory does not yet exist, the instrument automatically creates a new directory, using the instrument name and `/var/user/` by default.

**Parameters:**

<Directory> string  
\*RST: `/var/user/`

**Example:** See [Example "Store a hard copy of the display"](#) on page 939

**Manual operation:** See ["Path..."](#) on page 733

---

**:HCOPY:FILE[:NAME]:AUTO:DIRectory:CLEar**

Deletes all files with extensions `*.bmp`, `*.jpg`, `*.png` and `*.xpm` in the directory set for automatic naming.

**Example:** See [Example "Store a hard copy of the display"](#) on page 939

**Usage:** Event

**Manual operation:** See ["Clear Path"](#) on page 733

---

**:HCOPY:FILE[:NAME]:AUTO:FILE?**

Queries the name of the automatically named hard copy file.

An automatically generated file name consists of:

<Prefix><YYYY><MM><DD><Number>.<Format>.

You can activate each component separately, to individually design the file name.

**Return values:**

<File> string

**Example:** See [Example "Store a hard copy of the display"](#) on page 939.

**Usage:** Query only

---

**:HCOPY:FILE[:NAME]:AUTO:STATe <State>**

Activates automatic naming of the hard copy files.

**Parameters:**

<State>            1 | ON | 0 | OFF  
\*RST:            1

**Example:**            See [Example "Store a hard copy of the display"](#) on page 939

**Manual operation:**    See ["Automatic Naming"](#) on page 732

---

**:HCOPY:FILE[:NAME]:AUTO[:FILE]:DAY:STATe <State>****:HCOPY:FILE[:NAME]:AUTO[:FILE]:MONTH:STATe <State>****:HCOPY:FILE[:NAME]:AUTO[:FILE]:YEAR:STATe <State>**

Uses the date parameters (year, month or day) for the automatic naming. You can activate each of the date parameters separately.

**Parameters:**

<State>            1 | ON | 0 | OFF  
\*RST:            1

**Example:**            See [Example "Store a hard copy of the display"](#) on page 939

**Manual operation:**    See ["Prefix, Year, Month, Day"](#) on page 734

---

**:HCOPY:FILE[:NAME]:AUTO[:FILE]:NUMBer?**

Queries the number that is used as part of the file name for the next hard copy in automatic mode.

At the beginning, the count starts at 0. The R&S SMW200A searches the specified output directory for the highest number in the stored files. It increases this number by one to achieve a unique name for the new file.

The resulting auto number is appended to the resulting file name with at least three digits.

**Return values:**

<Number>           integer  
Range:            0 to 999999  
\*RST:            0

**Example:**            See [Example "Store a hard copy of the display"](#) on page 939

**Usage:**                Query only

**Manual operation:**    See ["Current Auto Number"](#) on page 734

---

**:HCOPY:FILE[:NAME]:AUTO[:FILE]:PREFIX** <Prefix>

**:HCOPY:FILE[:NAME]:AUTO[:FILE]:PREFIX:STATe** <State>

Uses the prefix for the automatic generation of the file name, provided `PREF:STAT` is activated.

**Parameters:**

<State> 1 | ON | 0 | OFF  
 \*RST: 1

**Example:** See [Example "Store a hard copy of the display"](#) on page 939

**Manual operation:** See ["Prefix, Year, Month, Day"](#) on page 734

## 14.15 KBOard subsystem

The KBOard subsystem contains the commands to set a connected keyboard.

<a href="#">:FPANel:KEYBoard:LAYout</a> .....	944
<a href="#">:KBOard:LAYout</a> .....	944

---

**:FPANel:KEYBoard:LAYout** <Layout>

Selects the layout of the front panel keypad.

**Parameters:**

<Layout> DIGits | LETTers

**DIGits**

Enables numerical keys only.

**LETTers**

Enables numerical and alphanumerical keys.

\*RST: n.a. (factory preset: DIGits)

**Example:**

```
:FPANel:KEYBoard:LAYout LETTers
// enables the alphanumerical additional
// and the numerical assignment of the keys.
```

**Manual operation:** See ["Alphanumeric Keys"](#) on page 739

---

**:KBOard:LAYout** <Layout>

Selects the language for an external keyboard and assigns the keys accordingly.

**Parameters:**

<Layout> CHINese | DANish | DUTCh | ENGLish | ENGUk | FINNish |  
 FRENch | FREBe | FRECa | GERMan | ITALian | JAPANese |  
 KORean | NORWegian | PORTuguese | RUSSian | SPANish |  
 SWEDish | ENGUS

\*RST: n.a. (factory preset: ENGLish)



**Example:**                   :KBOard:LAYout US  
                              // activates American keyboard

**Manual operation:** See "[Layout](#)" on page 738

## 14.16 OUTPut subsystem

In the OUTPut subsystem, you can configure the output signals.

The LF output signal is defined with the commands of the [Section 14.19.12](#), "[SOURce:LFOutput subsystem](#)", on page 1227 system.

### Common suffixes

The following common suffixes are used in remote commands:

Suffix	Value range	Description
OUTPut<hw>	[1]   2	Signal path

:OUTPut:ALL[:STATe].....	945
:OUTPut<hw>[:STATe].....	945
:OUTPut<hw>[:STATe]:PON.....	946
:OUTPut<hw>:AMODE.....	946
:OUTPut<hw>:BLANK:LIST:STATe.....	947
:OUTPut<hw>:IMPedance?.....	947
:OUTPut<hw>:AFIXed:RANGe:LOWer?.....	947
:OUTPut<hw>:AFIXed:RANGe:UPPer?.....	947
:OUTPut<hw>:PROTection:CLEar.....	948
:OUTPut<hw>:PROTection:STATe.....	948
:OUTPut<hw>:PROTection:TRIPped?.....	948

---

### :OUTPut:ALL[:STATe] <State>

Enables all RF output signals of the instrument.

#### Parameters:

<State>                   1 | ON | 0 | OFF  
                              \*RST:            n.a. (factory preset: 0)

**Example:**                   OUTPut:ALL:STATe 0  
                              Disables all RF output signals.

**Manual operation:** See "[RF State/RF ON](#)" on page 479

---

### :OUTPut<hw>[:STATe] <State>

Activates the RF output signal.

**Parameters:**

<State> 1 | ON | 0 | OFF  
 \*RST: 0

**Example:**

:OUTPut1 ON  
 Activates the RF output.

**Manual operation:** See ["RF State/RF ON"](#) on page 479

:OUTPut<hw>[:STATe]:PON <Pon>

Defines the state of the RF output signal when the instrument is switched on.

**Parameters:**

<Pon> OFF | UNCHanged  
 \*RST: n.a. (factory preset: UNCHanged)

**Example:**

:OUTPut1:PON OFF  
 The RF output is deactivated when the instrument is switched on.

**Manual operation:** See ["Power-On State"](#) on page 740

:OUTPut<hw>:AMODE <AMode>

Sets the step attenuator mode at the RF output.

**Note:** The setting [:SOURce<hw>]:POWer:ATTenuation:RFOff:MODE **FATTenuation** has higher priority than the attenuator modes **FIXed** and **MANual**.

**Parameters:**

<AMode> FIXed | MANual | AUTO

**AUTO**

The step attenuator adjusts the level settings automatically, within the full variation range.

**FIXed**

The step attenuator and amplifier stages are fixed at the current position, providing level settings with constant output VSWR. The resulting variation range is calculated according to the position.

To use this mode, activate the ALC (see [:SOURce<hw>]:POWer:ALC[:STATe]).

**MANual**

You can set the level manually, in 10 dB steps.

\*RST: AUTO

**Example:**

:SOURce1:POWer:ALC:STATe 1  
 :OUTPut1:AMODE FIXed

**Manual operation:** See ["Mode"](#) on page 582

---

**:OUTPut<hw>:BLANk:LIST:STATe <State>**

Activates RF output blanking.

**Parameters:**

<State> 1 | ON | 0 | OFF  
\*RST: 1

**Example:** :OUTPut1:BLAN:LIST:STAT ON  
Activates the RF output blanking.

---

**:OUTPut<hw>:IMPedance?**

Queries the impedance of the RF outputs.

**Return values:**

<Impedance> G1K | G50 | G10K  
\*RST: G50

**Example:** :OUTPut1:IMP?  
queries the impedance of RF output.  
Response: 50  
the impedance is 50 ohms

**Usage:** Query only

**Manual operation:** See "[RF output impedance](#)" on page 479

---

**:OUTPut<hw>:AFIXed:RANGe:LOWer?****:OUTPut<hw>:AFIXed:RANGe:UPPer?**

Queries the settable minimum/maximum value in mode :OUTPut:AMODE FIXed, i.e. when the attenuator is not being adjusted.

See :OUTPut<hw>:AMODE on page 946

**Return values:**

<Upper> float  
Increment: 0.01  
Default unit: dBm

**Example:** :OUTPut1:AMODE FIXed  
:OUTPut1:AFIXed:RANGe:UPPer?  
// -27  
:OUTPut1:AFIXed:RANGe:LOW?  
// -50

**Usage:** Query only

**Manual operation:** See "[Level Range](#)" on page 489

---

---

**:OUTPut<hw>:PROTection:CLEar**

Resets the protective circuit after it has been tripped.

To define the output state, use the command `:OUTPut<hw>[:STATE]`.

**Example:** `:OUTPut1:PROT:CLE`  
Resets the protective circuit of the RF output.

**Usage:** Event

**Manual operation:** See "Overload" on page 584

---

**:OUTPut<hw>:PROTection:STATe <State>**

Attenuates the RF output signal for about 40 dB to protect external devices against internal signals.

**Parameters:**  
<State> 1 | ON | 0 | OFF  
\*RST: 0

**Example:** `:OUTPut1:PROT:STAT ON`  
Attenuates the RF Output signal for about 40 dB.

**Manual operation:** See "Overload" on page 584

---

**:OUTPut<hw>:PROTection:TRIPped?**

Queries the state of the protective circuit.

**Return values:**  
<Tripped> 1 | ON | 0 | OFF  
\*RST: 0

**Example:** `:OUTPut1:PROT:TRIP`  
queries the state of the protective circuit of the RF output.  
Response: 0  
the protective circuit has not tripped.

**Usage:** Query only

**Manual operation:** See "Overload" on page 584

---

## 14.17 SENSE, READ, INITiate and SLISt subsystems

These subsystems contain the commands for configuring the power measurements with R&S NRP power sensor connected to the R&S SMW200A.



The local state is set with the `INIT` command. Switching off the local state enhances the measurement performance. Measurements results can be retrieved in local state on or off.

Sensor parameters are set with the `SENSe` commands.

To start the measurement and retrieve the result, use the `:READ<ch>[:POWer]?` command.

Suffix	Value range	Description
<code>SENSe&lt;ch&gt;</code>	[1] to 4	Indicates the sensor Sensor mapping: <ul style="list-style-type: none"> <li>• <code>SENSe[1]</code> - default mapping for sensors connected to the [SENSOR] connector</li> <li>• <code>SENSe2</code> - sensor connected to a [USB] connector</li> <li>• <code>SENSe3 4</code> - further connected sensors to [USB] connectors, in the connection order</li> </ul> Use the <code>:SLISt</code> commands to change the sensor mapping
<code>READ&lt;ch&gt;</code>	[1] to 4	Sensor assignment
<code>INITiate&lt;hw&gt;</code>	[1] to 4	Sensor assignment
<code>ELEMent&lt;ch&gt;</code>	[1] to 25	Sensor-mapping list

## Programming examples

### Example: Detecting and assigning a power sensor

```

SLISt:LIST?
// Response: "NRP33SN-V-900007-USB Legacy","NRP-Z211-900001-USB Legacy"
// Lists all automatically detected sensors.

SLISt:SCAN:STATe 1
// Searches for sensors connected in the LAN or via the USBTMC protocol.

SLISt:SCAN:LSEnsor 'NRQ6',101624 // sensor name, serial number
SLISt:SCAN:LSEnsor 11.123.1.123, 101624 // IP address, serial number
// Adds sensors to the list, that are connected to LAN.

SLISt:SCAN:USEnsor 'NRQ6',101624 //sensor name, serial number
SLISt:SCAN:USEnsor #H15b,101624 //device ID (hexadecimal), serial number
SLISt:SCAN:USEnsor 347,101624 //device ID (decimal), serial number
// Adds a sensor to the list, that is connected to the USB interface.

SLISt:LIST?
// Response: "NRP33SN-V-900007-USB Legacy","NRP-Z211-900001-USB Legacy",
// "NRP33SN-V-900005-USBTMC","NRP33SN-V-900011-LAN"
// Lists all automatically detected sensors.

SLISt:ELEMent3:MAPPing SENS1
// Maps the third sensor from the list to the first sensor channel.

SLISt:SENSor:MAP "NRPS18S-100654-USB Legacy", SENS3
// Maps the sensor to channel 3.

SLISt:CLEar[ALL]
// Remove all sensors from the list.
SLISt:CLEar:LAN
// Remove all sensors from the list, that are connected over LAN.
SLISt:CLEar:USB
// Remove all sensors from the list, that are connected over USB.

```

### Example: Performing a simple power measurement

**Prerequisite:** The sensor is connected to the instrument and mapped to the first sensor channel.

```

INITiate1:CONTinuous ON
// Switches the continuous power measurement on.

READ1?
// Triggers the measurement and displays the results.

```

**Example: Performing a power measurement with a fixed filter**

**Prerequisite:** The sensor is connected to the instrument and mapped to the first sensor channel.

```

SENSe1:SOURce RF
// Sensor measures the power of the RF signal.

SENSe1:FILTer:TYPE NSRatio
// Selects fixed noise filter mode.

SENSe1:FILTer:NSRatio 0.02 DB
// Sets the maximum noise component in the result to 0.02 DB.

SENSe1:FILTer:NSRatio:MTIME 10
//Limits the settling time to 10 seconds.

SENSe1:APERture:DEFault:STATe 0
// Deactivates the default aperture time of the sensor.

SENSe1:APERture:TIME 10e-6
// Sets the aperture time to 10 us.

SENSe1:UNIT DBM
// Selects unit dBm for the measured value.

INITiate:CONTinuous ON
// Switches the continuous power measurement on.

READ?
// Triggers the measurement and displays the results.

```

:SLISt[:LIST]?	952
:SLISt:SCAN[:STATe]	952
:SLISt:SCAN:LSEnSor	952
:SLISt:SCAN:USEnSor	953
:SLISt:CLEar:LAN	953
:SLISt:CLEar:USB	953
:SLISt:CLEar[:ALL]	954
:SLISt:ELEMent<ch>:MAPPing	954
:SLISt:SENsOr:MAP	954
:INITiate<hw>[:POWer]:CONTinuous	954
:READ<ch>[:POWer]?	955
:SENSe<ch>:UNIT[:POWer]	956
:SENSe<ch>[:POWer]:APERture:DEFault:STATe	956
:SENSe<ch>[:POWer]:APERture:TIME	956
:SENSe<ch>[:POWer]:CORRection:SPDevice:SELect	957
:SENSe<ch>[:POWer]:CORRection:SPDevice:STATe	957
:SENSe<ch>[:POWer]:CORRection:SPDevice:LIST?	957
:SENSe<ch>[:POWer]:DISPlay:PERManent:PRiority	957
:SENSe<ch>[:POWer]:DISPlay:PERManent:STATe	958
:SENSe<ch>[:POWer]:FILTer:LENGth:AUTO?	958

:SENSe<ch>[:POWer]:FILTer:LENGth[:USER].....	958
:SENSe<ch>[:POWer]:FILTer:NSRatio.....	959
:SENSe<ch>[:POWer]:FILTer:NSRatio:MTIME.....	959
:SENSe<ch>[:POWer]:FILTer:SONCe.....	959
:SENSe<ch>[:POWer]:FILTer:TYPE.....	960
:SENSe<ch>[:POWer]:FREQUency.....	960
:SENSe<ch>[:POWer]:LOGGing:STATe.....	961
:SENSe<ch>[:POWer]:OFFSet.....	961
:SENSe<ch>[:POWer]:OFFSet:STATe.....	961
:SENSe<ch>[:POWer]:SNUMber?.....	962
:SENSe<ch>[:POWer]:SOURce.....	962
:SENSe<ch>[:POWer]:STATus[:DEVice]?.....	962
:SENSe<ch>[:POWer]:SVERsion?.....	963
:SENSe<ch>[:POWer]:TYPE?.....	963
:SENSe<ch>[:POWer]:ZERO.....	963

---

### :SLISt[:LIST]?

Returns a list of all detected sensors in a comma-separated string.

#### Return values:

<SensorList>                      String of comma-separated entries  
 Each entry contains information on the sensor type, serial number and interface.  
 The order of the entries does not correspond to the order the sensors are displayed in the "NRP Sensor Mapping" dialog.

**Example:**                      See [Example "Detecting and assigning a power sensor"](#) on page 950.

**Usage:**                          Query only

**Manual operation:**        See "[Sensor Mapping List](#)" on page 615

---

### :SLISt:SCAN[:STATe] <State>

Starts the search for R&S NRP power sensors, connected in the LAN or via the USBTMC protocol.

#### Parameters:

<State>                              1 | ON | 0 | OFF  
 \*RST:                                0

**Example:**                      See [Example "Detecting and assigning a power sensor"](#) on page 950.

**Manual operation:**        See "[Scan](#)" on page 616

---

### :SLISt:SCAN:LSENsor <IP>

Scans for R&S NRP power sensors connected in the LAN.



**Setting parameters:**

<IP> string  
 \*RST: 0

**Example:** See [Example "Detecting and assigning a power sensor"](#) on page 950.

**Usage:** Setting only

**Manual operation:** See ["Add LAN Sensor"](#) on page 616

**:SLISt:SCAN:USENSor** <DeviceID>, <Serial>

Scans for R&S NRP power sensors connected over a USB interface.

**Parameters:**

<Serial> integer  
 Range: 0 to 999999

**Setting parameters:**

<DeviceID> String or Integer  
 Range: 0 to 999999  
 \*RST: 0

**Example:** See [Example "Detecting and assigning a power sensor"](#) on page 950.

**Usage:** Setting only

**Manual operation:** See ["Add USBTMC Sensor"](#) on page 617

**:SLISt:CLEAr:LAN**

Removes all R&S NRP power sensors connected in the LAN from the list.

**Example:** See [Example "Detecting and assigning a power sensor"](#) on page 950.

**Usage:** Event

**Manual operation:** See ["Clear"](#) on page 616

**:SLISt:CLEAr:USB**

Removes all R&S NRP power sensors connected over USB from the list.

**Example:** See [Example "Detecting and assigning a power sensor"](#) on page 950.

**Usage:** Event

**Manual operation:** See ["Clear"](#) on page 616

---

**:SLISt:CLEAr[:ALL]**

Removes all R&S NRP power sensors from the list.

**Example:** See [Example "Detecting and assigning a power sensor"](#) on page 950.

**Usage:** Event

**Manual operation:** See ["Clear"](#) on page 616

---

**:SLISt:ELEMent<ch>:MAPPING <Mapping>**

Assigns an entry from the `:SLISt[:LIST]?` to one of the four sensor channels.

**Parameters:**

<Mapping> SENS1 | SENSor1 | SENS2 | SENSor2 | SENS3 | SENSor3 |  
SENS4 | SENSor4 | UNMapped

Sensor channel.

\*RST: UNMapped

**Example:** See [Example "Detecting and assigning a power sensor"](#) on page 950.

**Manual operation:** See ["Sensor Mapping List"](#) on page 615

---

**:SLISt:SENSor:MAP <SensorId>, <Mapping>**

Assigns a sensor directly to one of the sensor channels, using the sensor name and serial number.

To find out the the sensor name and ID, you can get it from the label of the R&S NRP, or using the command `:SLISt:SCAN[:STATe]`. This command detects all R&S NRP power sensors connected in the LAN or via 'USBTMC protocol.

**Setting parameters:**

<SensorId> string

<Mapping> enum

**Example:** See [Example "Detecting and assigning a power sensor"](#) on page 950.

**Usage:** Setting only

**Manual operation:** See ["Sensor Mapping List"](#) on page 615

---

**:INITiate<hw>[:POWER]:CONTInuous <Continuous>**

Switches the local state of the continuous power measurement by R&S NRP power sensors on and off. Switching off local state enhances the measurement performance during remote control.

The remote measurement is triggered with `:READ<ch>[:POWer]?`. This command also returns the measurement results. The local state is not affected, measurement results can be retrieved with local state on or off.

**Parameters:**

<Continuous>      1 | ON | 0 | OFF  
 \*RST:              0

**Example:**

INIT1:CONT ON  
 Switches on the local state of continuous power measurement.

**Manual operation:** See ["State"](#) on page 611

**:READ<ch>[:POWer]?**

Triggers power measurement and displays the results.

**Note:** This command does not affect the local state, i.e. you can get results with local state on or off. For long measurement times, we recommend that you use an SRQ for command synchronization (MAV bit).

**Suffix:**

<ch>                1 to 3

**Return values:**

<Power>            float or float,float

The sensor returns the result in the unit set with command `:SENSe<ch>:UNIT[:POWer]`

Certain power sensors, such as the R&S NRP-Z81, return two values, first the value of the average level and - separated by a comma - the peak value.

**Example:**

:SENS1:UNIT DBM  
 Selects unit dBm for presentation of measurement result.  
 :READ1?  
 Queries the measurement result of the sensor.  
 -45.6246576745440230  
 -45.6 dBm were measured at the given frequency.

**Example:**

R&S NRP-Z81  
 :READ1?  
 -55.62403263352178, -22.419472478812476  
 -55.6 dBm is the measured average level, -22.4 dBm is the measured peak level at the given frequency.

**Usage:**

Query only

**Manual operation:**

See ["Measured Level"](#) on page 607  
 See ["Level \(Peak\) / Level \(Average\)"](#) on page 611

---

**:SENSe<ch>:UNIT[:POWer] <Power>**

Selects the unit (Watt, dBm or dB $\mu$ V) of measurement result display, queried with `:READ<ch>[:POWer]?`.

**Parameters:**

<Power> DBM | DBUV | WATT  
\*RST: DBM

**Example:**

```
:SENS2:UNIT DBM
Selects dBm as unit for the measured value returned by command READ.
:READ2?
Response: 7.34
7.34 dBm are measured by sensor 2.
```

**Manual operation:** See ["Measured Level"](#) on page 607  
See ["Level \(Peak\) / Level \(Average\)"](#) on page 611

---

**:SENSe<ch>[:POWer]:APERTure:DEFault:STATe <UseDefAp>**

Deactivates the default aperture time of the respective sensor.

To specify a user-defined value, use the command `:SENSe<ch>[:POWer]:APERTure:TIME` on page 956.

**Parameters:**

<UseDefAp> 1 | ON | 0 | OFF  
\*RST: 1

**Example:** See [Example "Performing a power measurement with a fixed filter"](#) on page 951.

**Manual operation:** See ["Default Aperture Time"](#) on page 614

---

**:SENSe<ch>[:POWer]:APERTure:TIME <ApTime>**

Defines the aperture time (size of the acquisition interval) for the corresponding sensor.

**Parameters:**

<ApTime> float  
Range: depends on connected power sensor  
Increment: 1E-9  
\*RST: depends on connected power sensor

**Example:** See [Example "Performing a power measurement with a fixed filter"](#) on page 951.

**Manual operation:** See ["Aperture Time"](#) on page 614

---

**:SENSe<ch>[:POWer]:CORRection:SPDeVice:SElect <Select>**

Several S-parameter tables can be stored in a sensor. The command selects a loaded data set for S-parameter correction for the corresponding sensor.

**Parameters:**

<Select> float  
\*RST: 0

**Manual operation:** See "[S-Parameter](#)" on page 614

---

**:SENSe<ch>[:POWer]:CORRection:SPDeVice:STATe <State>**

Activates the use of the S-parameter correction data.

**Note:** If you use power sensors with attenuator, the instrument automatically activates the use of S-parameter data.

**Parameters:**

<State> 1 | ON | 0 | OFF  
\*RST: 0

**Example:** :SENSe1:POWer:CORRection:SPDeVice:STATe 1  
Activates the use of the S-parameters correction data.

**Manual operation:** See "[S-Parameter](#)" on page 614

---

**:SENSe<ch>[:POWer]:CORRection:SPDeVice:LIST?**

Queries the list of the S-parameter data sets that have been loaded to the power sensor.

**Return values:**

<List> string list  
\*RST: 0

**Usage:** Query only

**Manual operation:** See "[S-Parameter](#)" on page 614

---

**:SENSe<ch>[:POWer]:DISPlay:PERMANent:PRiority <Priority>**

Selects average or peak power for permanent display.

**Parameters:**

<Priority> AVERAge | PEAK  
\*RST: AVERAge

**Example:** :SENSe1:DISP:PERM:STAT ON  
Turns on the permanent view.  
:SENSe1:DISP:PERM:PRI AVER  
Sets the average power for display.

**Manual operation:** See "[Display](#)" on page 611

---

**:SENSe<ch>[:POWer]:DISPlay:PERMANent:STATe <State>**

Activates the permanent display of the measured power level results. The instrument also indicates the sensor type, the connection, the measurement source and the offset if set.

**Parameters:**

<State> 1 | ON | 0 | OFF  
\*RST: 0

**Example:** :SENS1:POW:DISP:PERM:STAT ON  
Turns on the permanent view.

**Manual operation:** See "[Display Permanent](#)" on page 611

**:SENSe<ch>[:POWer]:FILTer:LENGth:AUTO?**

Queries the current filter length in filter mode AUTO ([:SENSe<ch>\[:POWer\]:FILTer:TYPE](#))

**Return values:**

<Auto> float  
Range: 1 to depends on R&S NRP power sensor type

**Example:** :SENS1:FILT:TYPE AUTO  
Selects auto filter.  
:SENS1:FILT:LENG:AUTO?  
Queries the automatically set filter length.  
Response: 1024

**Usage:** Query only

**Manual operation:** See "[Filter Length](#)" on page 613

**:SENSe<ch>[:POWer]:FILTer:LENGth[:USER] <User>**

Selects the filter length for [SENS:POW:FILT:TYPE USER](#). As the filter length works as a multiplier for the time window, a constant filter length results in a constant measurement time (see also "[About the measuring principle, averaging filter, filter length, and achieving stable results](#)" on page 602).

The R&S NRP power sensors provide different resolutions for setting the filter length, depending on the used sensor type.

For more information, refer to the specifications document.

**Parameters:**

<User> float  
Range: 1 to depends on R&S NRP power sensor type  
\*RST: 1

**Example:**                   :SENS1:FILT:TYPE USER  
 Selects user filter mode.  
                               :SENS1:FILT:LENG 16  
 Sets a filter length of 16. E.g. using a sensor with 20 ms time window, the resulting measurement time is 640 ms (2x16x20 ms)

**Manual operation:** See ["Filter Length"](#) on page 613

**:SENSe<ch>[:POWer]:FILTer:NSRatio <NSRatio>**

Sets an upper limit for the relative noise content in fixed noise filter mode (:SENSe<ch>[:POWer]:FILTer:TYPE). This value determines the proportion of intrinsic noise in the measurement results.

**Parameters:**

<NSRatio>                   float  
                               Range:     0.001 to 1  
                               Increment: 0.001  
                               \*RST:     0.01

**Example:**                   See [Example "Performing a power measurement with a fixed filter"](#) on page 951.

**Manual operation:** See ["Noise/Signal Ratio"](#) on page 613

**:SENSe<ch>[:POWer]:FILTer:NSRatio:MTIME <MTime>**

Sets an upper limit for the settling time of the auto-averaging filter and thus limits the length of the filter.

**Parameters:**

<MTime>                   float  
                               Range:     1 to 999.99  
                               Increment: 0.01  
                               \*RST:     4

**Example:**                   See [Example "Performing a power measurement with a fixed filter"](#) on page 951.

**Manual operation:** See ["Timeout"](#) on page 613

**:SENSe<ch>[:POWer]:FILTer:SONCe**

Starts searching the optimum filter length for the current measurement conditions. You can check the result with command :SENS1:POW:FILT:LENG:USER? in filter mode USER (:SENSe<ch>[:POWer]:FILTer:TYPE).

**Example:**           SENS1:FILT:TYPE USER  
                           Selects user filter mode.  
                           :SENS1:FILT:SONC  
                           Activates the search for the optimum filter length.  
                           :SENS1:FILT:LENG?  
                           Returns the found optimum filter length.  
                           Response: 128

**Usage:**            Event

**Manual operation:** See "Auto Once" on page 613

**:SENSe<ch>[:POWER]:FILTer:TYPE <Type>**

Selects the filter mode. The filter length is the multiplier for the time window and thus directly affects the measurement time.

**Parameters:**

<Type>

AUTO | USER | NSRatio

**AUTO**

Automatically selects the filter length, depending on the measured value. The higher the power, the shorter the filter length, and vice versa.

**Note:** To avoid long settling times when the power is low, you can limit the averaging factor limited with the "timeout" parameter (:SENSe<ch>[:POWER]:FILTer:NSRatio:MTIME).

**USER**

Allows you to set the filter length manually. As the filter-length takes effect as a multiplier of the measurement time, you can achieve constant measurement times.

**NSRatio**

Selects the filter length (averaging factor) according to the criterion that the intrinsic noise of the sensor (2 standard deviations) does not exceed the specified noise content. You can define the noise content with command :SENSe<ch>[:POWER]:FILTer:NSRatio.

\*RST:            AUTO

**Example:**            See [Example "Performing a power measurement with a fixed filter"](#) on page 951.

**Manual operation:** See "Filter" on page 612

**:SENSe<ch>[:POWER]:FREQUency <Frequency>**

Sets the RF frequency of the signal, if signal source :SENSe<ch>[:POWER]:SOURce USER is selected.



**Parameters:**

<Frequency> float  
 \*RST: 1 GHz

**Example:**

```
:SENS1:SOUR USER
Selects user-defined source.
:SENS1:FREQ 2.44GHz
Sets the RF frequency of the source which is 2.44 GHz.
```

**Manual operation:** See "[Frequency](#)" on page 612

**:SENSe<ch>[:POWer]:LOGGing:STATe <State>**

Activates the recording of the power values, measured by a connected R&S NRP power sensor.

**Parameters:**

<State> 1 | ON | 0 | OFF  
 \*RST: 0

**Example:**

```
:SENS:LOGG:STAT ON
Activates recording of the power measurement of the first sensor.
```

**Manual operation:** See "[Enable Logging](#)" on page 614

**:SENSe<ch>[:POWer]:OFFSet <Offset>**

Sets a level offset which is added to the measured level value after activation with command `:SENSe<ch>[:POWer]:OFFSet:STATe`. The level offset allows, e.g. to consider an attenuator in the signal path.

**Parameters:**

<Offset> float  
 Range: -100.0 to 100.0  
 \*RST: 0  
 Default unit: dB

**Example:**

```
:SENS1:POW:OFFS 10.0
Sets a level offset of 10 dB
```

**Manual operation:** See "[Level Offset State,Level Offset](#)" on page 612

**:SENSe<ch>[:POWer]:OFFSet:STATe <State>**

Activates the addition of the level offset to the measured value. The level offset value is set with command `:SENSe<ch>[:POWer]:OFFSet`.

**Parameters:**

<State> 1 | ON | 0 | OFF  
 \*RST: 0

**Example:**                   :SENS1:POW:OFFS 0.4dB  
 Sets a level offset of 0.4 dB  
                               :SENS1:POW:OFFS:STAT ON  
 A level offset of 0.4 dB is added to the measured value.

**Manual operation:** See "[Level Offset State,Level Offset](#)" on page 612

#### :SENSe<ch>[:POWer]:SNUMber?

Queries the serial number of the sensor.

**Return values:**

<SNumber>               string

**Example:**               :SENS1:SNUM?  
 Queries the serial number.

**Usage:**                 Query only

**Manual operation:** See "[Sensor type and serial number](#)" on page 611

#### :SENSe<ch>[:POWer]:SOURce <Source>

Determines the signal to be measured.

**Note:** When measuring the RF signal, the sensor considers the corresponding correction factor at that frequency, and uses the level setting of the instrument as reference level.

**Parameters:**

<Source>                A | USER | RF | B  
 \*RST:                 A

**Example:**               See [Example "Performing a power measurement with a fixed filter"](#) on page 951.

**Manual operation:** See "[Use Frequency Of](#)" on page 612

#### :SENSe<ch>[:POWer]:STATus[:DEVice]?

Queries if a sensor is connected to the instrument.

**Return values:**

<Status>                1 | ON | 0 | OFF  
 \*RST:                 0

**Example:**               :SENS1:STAT?  
 Response: 1  
 A sensor is connected.

**Usage:**                 Query only

**Manual operation:** See "[State](#)" on page 611

---

**:SENSe<ch>[:POWer]:SVERsion?**

Queries the software version of the connected R&S NRP power sensor.

**Return values:**

<SVersion>                    string

**Example:**                    :SENS1:POW:SVER?

Queries the software version of the power sensor.

**Usage:**                      Query only

---

**:SENSe<ch>[:POWer]:TYPE?**

Queries the sensor type. The type is automatically detected.

**Return values:**

<Type>                         string

**Example:**                    :SENS1:TYPE?

Queries the type of sensor.

Response: NRP-Z21

The R&S NRP-Z21 sensor is used.

**Usage:**                      Query only

**Manual operation:**    See "[Sensor type and serial number](#)" on page 611

---

**:SENSe<ch>[:POWer]:ZERO**

Performs zeroing of the sensor.

Zeroing is required after warm-up, i.e. after connecting the sensor.

**Note:** Switch off or disconnect the RF power source from the sensor before zeroing.

We recommend that you zero in regular intervals (at least once a day), if:

- The temperature has varied more than about 5 °C.
- The sensor has been replaced.
- You want to measure very low power.

**Example:**                    :SENS1:ZERO

Executes zeroing.

**Usage:**                      Event

**Manual operation:**    See "[Zero](#)" on page 611

---

## 14.18 SCONfiguration subsystem

The SCONfiguration subsystem contains the commands to define the system configuration, stream mapping and baseband configuration.

### Required options

See ["Required options"](#) on page 118.

### Common suffixes

The commands in this chapter use the following common suffixes:

Suffix	Suffix range	Description	Required options
BBMM<ch>	1 to 2	HS DIG I/Q input or output connectors	R&S SMW-B13XT R&S SMW-B9 + R&S SMW-K19 per connector
CHANnel<ch0>	0 to 7	Channel number, up to 8 channels per HS DIG I/Q interface and maximum 8 channels for both interfaces.	R&S SMW-K19
CODer<ch>	1 to 2	DIG I/Q input connectors	R&S SMW-B10 per connector
FADer<ch>	1 to 4	DIG I/Q input or output connectors HS DIG I/Q input or output connectors	R&S SMW-B10 + R&S SMW-B14 R&S SMW-B9 + R&S SMW-B15
IQOutput<ch>	1 to 2	DIG I/Q output connectors	R&S SMW-B13/-B13T R&S SMW-B10 + R&S SMW-K19 per connector
RF<ch>	1 to 2	RF A/RF B connectors	Frequency option per path, for example, R&S SMW-B1003 + R&S SMW-B2003
STReam<st>	1 to 8	I/Q streams	-

See also [Section 4.3.4, "Supported digital interfaces and system configuration"](#), on page 113.

### Example: Distributing the streams to the output connectors

The following example lists the commands necessary to fulfill this task.

```
// *****
// Reset system configuration and enable 1x4x4 MIMO fading configuration.
// *****
SCONfiguration:PRESet
SCONfiguration:MODE ADVanced
SCONfiguration:FADing MIMO4X4
SCONfiguration:BASEband:SOURce COUPled
SCONfiguration:APPLY

// *****
// Map the I/Q streams to the output connectors.
// *****
```

```

SCONfiguration:OUTPut:MAPPing:RF1:STReam1:STATe ON
SCONfiguration:OUTPut:MAPPing:IQOutput1:STReam3:STATe ON

SCONfiguration:OUTPut:MAPPing:STReam1:FOffset 20E6
SCONfiguration:OUTPut:MAPPing:STReam1:POFFset 0
SCONfiguration:OUTPut:MAPPing:RF2:STReam2:STATe ON
SCONfiguration:OUTPut:MAPPing:IQOutput2:STReam4:STATe ON
// The digital I/Q outputs are not used.
SCONfiguration:OUTPut:MAPPing:BBMM1:STReam1:STATe OFF
SCONfiguration:OUTPut:MAPPing:BBMM2:STReam2:STATe OFF
SCONfiguration:OUTPut:MAPPing:FADer3:STReam3:STATe OFF
SCONfiguration:OUTPut:MAPPing:FADer4:STReam4:STATe OFF

// *****
// Alternatively, add stream A&C and B&D and output the signal at the digital IQ
// outputs BBMM1 and BBMM2.
SCONfiguration:OUTPut:MAPPing:BBMM1:MODE ADD
SCONfiguration:OUTPut:MAPPing:BBMM2:MODE ADD
SCONfiguration:OUTPut:MAPPing:BBMM1:STReam1:STATe ON
SCONfiguration:OUTPut:MAPPing:BBMM2:STReam2:STATe ON
SCONfiguration:OUTPut:MAPPing:BBMM1:STReam3:STATe ON
SCONfiguration:OUTPut:MAPPing:BBMM2:STReam4:STATe ON

```

### Example: Connecting and configuring external instruments

The following example lists commands to connect and configure external instruments.

```

// *****
// Scan interfaces and your network for connected instruments.
// *****
SCONfiguration:EXTErnal:DISPlay ALL
SCONfiguration:EXTErnal:REMOte:CLEan
SCONfiguration:EXTErnal:REMOte:SCAN
SCONfiguration:EXTErnal:REMOte:SCAN:STATe?
// Response: "0"
// The scanning procedure is finished.

// *****
// Specify characteristics at the input and output interfaces.
// *****
SCONfiguration:EXTErnal:CODeR1:DIRectiOn?
// Response: "IN"
SCONfiguration:EXTErnal:BBMM1:DIRectiOn?
// Response: "OUT"
SCONfiguration:EXTErnal:IQOutput1:DIRectiOn?
// Query the IQ connection state.
SCONfiguration:EXTErnal:CODeR1:IQConneCtion:STATe?
// Response: 1
SCONfiguration:EXTErnal:BBMM1:IQConneCtion:STATe?
// Response: 1

```

```

// *****
// Manage external instruments.
// *****
SCONfiguration:EXtErnal:REMOte:LIST?
// Response: "SMBV100B,SGS_2,SGT100A,SMBVB_1,SMBVB_2,SMW200A (100010)"
// Add instruments to selection.
SCONfiguration:EXtErnal:REMOte:ADD "SGS_1","USB","100007"
SCONfiguration:EXtErnal:REMOte:ADD "SMW200A (100001)","LAN","10.112.11.125","2"
SCONfiguration:EXtErnal:REMOte:LIST?
// Response: "SMBV100B,SGS_2,SGT100A,SMBVB_1,SMBVB_2,SMW200A (100010),SGS_1,
// SMW200A (100001)"
SCONfiguration:EXtErnal:REMOte:REName "SGS_2","SGS (102030)"
SCONfiguration:EXtErnal:REMOte:LIST?
// Response: "SMBV100B,SGS (102030),SGT100A,SMBVB_1,SMBVB_2,SMW200A (100010),SGS_1,
// SMW200A (100001)"

// *****
// Detect external instruments and connect them to the R&S SMW200A.
// *****
SCONfiguration:EXtErnal:BBMM1:REMOte:DETEct?
// Response: "SGT100A"
SCONfiguration:EXtErnal:BBMM1:REMOte:ISElect?
// Response: "SGT100A","A"
SCONfiguration:EXtErnal:BBMM1:REMOte:CONNEct
// Alternatively, combine instrument select and connect.
SCONfiguration:EXtErnal:BBMM1:REMOte:ICONnect "SGT100A","A"
SCONfiguration:EXtErnal:IQOutput1:REMOte:ISElect "SGS_1","A"
SCONfiguration:EXtErnal:IQOutput1:REMOte:CONNEct
// Alternatively, combine instrument select and connect.
SCONfiguration:EXtErnal:IQOutput1:REMOte:ICONnect "SGS_1","A"
// Query the connection state.
SCONfiguration:EXtErnal:IQOutput1:RCONNECTION:STATE?
// Response: 1
SCONfiguration:EXtErnal:BBMM1:RCONNECTION:STATE?
// Response: 1
// Query instrument names.
SCONfiguration:EXtErnal:CODer1:INAME?
SCONfiguration:EXtErnal:BBMM1:INAME?
// Response: "SGT100A [A]"
SCONfiguration:EXtErnal:IQOutput1:INAME?
// Response: "SGS_1 [A]"

// *****
// Specify characteristics of the IQ output signal.
// *****
SCONfiguration:EXtErnal:BBMM1:RF:COUPLing ON
SCONfiguration:EXtErnal:BBMM1:RF:FREQuency:OFFSet 0
SCONfiguration:EXtErnal:BBMM1:RF:POWer:OFFSet -10
OUTPut1:STATE ON
SCONfiguration:EXtErnal:BBMM1:RF:STATE?

```

```
// Response: 1
SCONfiguration:EXTErnal:IQOutput1:RF:COUPling OFF
SCONfiguration:EXTErnal:IQOutput1:RF:FREQuency 214300000
SCONfiguration:EXTErnal:IQOutput1:RF:POWEr -20
SCONfiguration:EXTErnal:IQOutput1:RF:STATe ON

// *****
// Specify the initialization sequence with a user-defined initialization file.
// *****
MMEMory:CDIREctory "/var/user/RcExtInstr"
SCONfiguration:EXTErnal:REMOte:INITialization:CATalog?
// Response: "init_seq_sgs"
SCONfiguration:EXTErnal:IQOutput1:REMOte:INITialization:FILE "init_seq_sgs.iec"

SCONfiguration:EXTErnal:ACONnect 1
*RST
SCONfiguration:EXTErnal:BBMM1:INAME?
// Response: timeout
SCONfiguration:EXTErnal:REMOte:PURGe
// Disconnect and disable remote control of the external instruments.
SCONfiguration:EXTErnal:REMOte:DISConnect[:ALL]
```

### Example: Configuring primary-secondary mode

```
// For the primary instrument:
SOURCE1:ROSCillator:SOURCE INT
SCONfiguration:MULTIinstrument:MODE PRIMary
SCONfiguration:MULTIinstrument:STATe 1
SCONfiguration:APPLY

SOURCE1:INPut:USER6:DIRection OUTP
OUTPut1:USER6:SIGNAL INSinc

SOURCE1:INPut:USER5:DIRection OUTP
OUTPut1:USER5:SIGNAL INSinc

// For the secondary instrument:
SOURCE1:ROSCillator:SOURCE EXT
SOURCE1:ROSCillator:EXTErnal:FREQuency 10MHZ
SCONfiguration:MULTIinstrument:MODE SECONdary
SCONfiguration:MULTIinstrument:STATe 1

SOURCE1:INPut:USER5:DIRection INP
SOURCE1:INPut:USER5:SIGNAL OUTSinc
SOURCE1:INPut:USER6:DIRection OUTP
OUTPut1:USER6:SIGNAL INSinc
SCONfiguration:MULTIinstrument:TRIGger:SYNChronization?
// SYNC
```

**Example: Generating digital signals**

```

SCONfiguration:PRESet
SCONfiguration:MODE ADVanced
SCONfiguration:OUTPut:MODE HSAL
SCONfiguration:FADing FAAFBB
SCONfiguration:BASEband:SOURce SEP
// Set six channels at the HS DIG I/Q
SCONfiguration:DIQ:BBMM1:CHANnels CH6
SCONfiguration:DIQ:BBMM2:CHANnels CH4
SCONfiguration:DIQ:BBMM1:CHANnels?
// Response: "CH4"
// Number of channels adapted so that the total number of channels is 8.
SCONfiguration:APPLy

```

See also [Example "Enabling and configuring the HS DIG I/Q digital outputs"](#) on page 1217.

**Example: Generating digital multiplexed signals**

The following is a general example. Not all required settings are considered.

```

// *****
// Reset the system configuration and enable a 1x2x8 MIMO fading config
SCONfiguration:PRESet
SCONfiguration:MODE ADVanced
SCONfiguration:FADing MIMO2X8

// Enable the generation of digital multiplexed signals
SCONfiguration:OUTPut:MODE DIGM
SCONfiguration:APPLy

// *****
// Verify the I/Q stream mapping
SCONfiguration:OUTPut:MAPPING:BBMM1:MODE?
// Response:  MULT
SCONfiguration:OUTPut:MAPPING:BBMM2:MODE?
// Response:  MULT
SCONfiguration:OUTPut:MAPPING:BBMM1:STReam1:STATe?
// Response:  1
SCONfiguration:OUTPut:MAPPING:BBMM1:STReam3:STATe?
// Response:  1
SCONfiguration:OUTPut:MAPPING:BBMM1:STReam5:STATe?
// Response:  1
SCONfiguration:OUTPut:MAPPING:BBMM1:STReam7:STATe?
// Response:  1
SCONfiguration:OUTPut:MAPPING:BBMM2:STReam2:STATe?
// Response:  1
SCONfiguration:OUTPut:MAPPING:BBMM2:STReam4:STATe?
// Response:  1
SCONfiguration:OUTPut:MAPPING:BBMM2:STReam6:STATe?
// Response:  1

```



```
SCONfiguration:OUTPut:MAPPING:BBMM2:STReam8:STATe?
// Response: 1
```

### Example: Controlling multiple instruments with the same application program

This section provides information on remote control of a multi-instrument setup with a remote computer (external controller). In these setups, synchronize remote commands (SCPI commands) that you send to the different instruments, see [Figure 14-3](#).

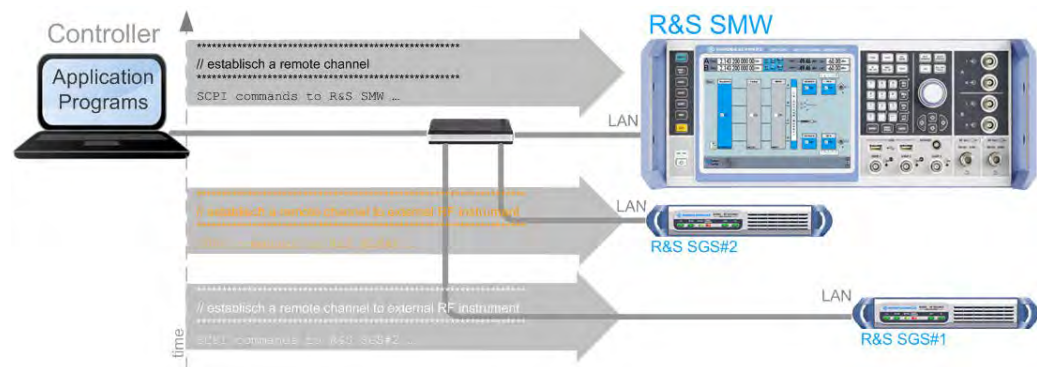

**Figure 14-3: Conventional way to remote control the R&S SMW200A and external RF instruments**

This example shows you how to use the same application program to control the external RF instruments via the R&S SMW200A, without opening remote sessions to these instruments.

### Overview of the possible solutions

Establish the remote control connections (LAN or USB) and I/Q connections to the external instruments first.

You can control these external instruments from the R&S SMW200A in one of the following ways:

- In manual operation:
  - Use the "System Config" > "External RF and I/Q" settings and the "External Instruments" > "Config" > "External Instrument Configuration" settings. For example, you can set the frequency and level of the connected instruments and activate or deactivate their RF outputs. See [Section 4.9.6, "How to connect and configure external instruments"](#), on page 189
  - Use the "External Instrument Configuration > Remote Control" settings to send individual SCPI commands or a sequence of SCPI commands to the connected external instruments.
- In remote operation:
  - Use the `SCONfiguration:...` remote control commands that correspond to settings in manual operation. See [Example "Connecting and configuring external instruments"](#) on page 965.
  - Use the `SCONfiguration:EXtErnal:<Connector>:REMOte:SEND` commands to control the connected RF instruments

See "Your R&S SMW200A as a controller of external instruments" on page 970.

The Figure 14-4 shows the extent of the particular solution.

„System Config > External RF and I/Q > External Instruments Configuration > Remote Control“

```

:SCONfiguration:EXTernal:<Connector>:REMOte:SEND „remote control commands“
e.g:
...
SCONfiguration:EXTernal:IQOUT1:REMOte:SEND „SOURCE:IQ:IMPAirment:LEAKage:I -1“
SCONfiguration:EXTernal:IQOUT1:REMOte:SEND „SOURCE:IQ:IMPAirment:IQRatio:MAGNitude?“
...
    
```

„System Config > External RF and I/Q > External Instruments Configuration > Initialization Sequence“

Subset of setting stored as an initialization file (\*.iec)

„System Config > External RF and I/Q“

Major instrument setting:

Instrument Name	RF On/Off	RF Frequency [MHz]	RF Level [dBm]	RF State
SGS [A]	<input type="checkbox"/>	12 750 000 000.0	-30.00	Off
SGS7 [A]	<input type="checkbox"/>	12 750 000 000.0	-30.00	Off

Any setting of the connected external instrument

Figure 14-4: Extent and impact of the provided solutions

Your R&S SMW200A as a controller of external instruments

The Figure 14-5 shows a simplified version of the test setup on Figure 4-24. The figure shows a configuration example of two R&S SGS, directly controlled by an R&S SMW200A. The figure illustrates the principle and does not show all connections.

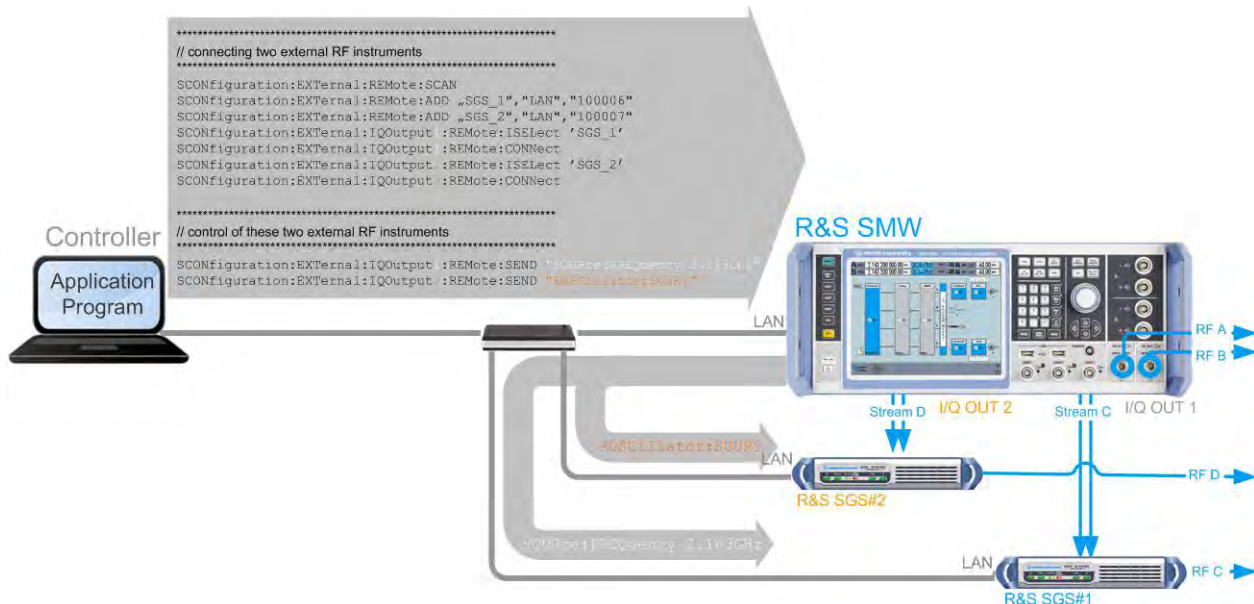

Figure 14-5: Remote control of external RF instruments via the R&S SMW200A

In this setup, a controller does not need to access the external instruments directly. Instead, the R&S SMW200A acts as a controller to these instruments.

We assume that:

- You control the R&S SMW200A from a remote controller
- The instruments are connected to a LAN and there is no active remote channel from the controller to the external instruments
- External RF instruments are connected to the R&S SMW200A, for example two R&S SGS.

### To control an external instrument from the R&S SMW200A remotely

Perform the following general steps:

1. Connect the external RF instruments to the R&S SMW200A.  
See:
  - [Section 4.9.5, "How to cable the instruments in MIMO test setups"](#), on page 188
  - ["To connect instruments to the I/Q analog interface"](#) on page 189
2. Connect a controller.
3. Establish a remote control connection to the R&S SMW200A.  
See [Section 13.8, "Setting up remote control"](#), on page 860.
4. Write an application program.
5. Use the `SCONfiguration:EXternal:<Connector>:REMOte:SEND` commands to control the connected RF instruments.  
See also [Example "Connecting an external instrument and sending SCPI commands"](#) on page 971.

### Example: Connecting an external instrument and sending SCPI commands

The following example lists the commands necessary to fulfill this task. This example uses the configuration made in [Example "Connecting and configuring external instruments"](#) on page 965.

We assume that an external instrument (R&S SGT) is connected to the BBMM1 connector.

```
SCONfiguration:EXternal:DISPlay ALL
SCONfiguration:EXternal:REMOte:CLEan
SCONfiguration:EXternal:REMOte:SCAN

SCONfiguration:EXternal:BBMM1:IQConnection:STATE?
// Response: 1

SCONfiguration:EXternal:REMOte:LIST?
// Response: SMBV100A,SGS_2,SGT100A,SMBV_1,SMBV_2,SMU200A (100010),SGS_1,SMU200A (100001)

// Detecting a connected external instrument and connecting it
SCONfiguration:EXternal:BBMM1:REMOte:DETEct?
// Response: "SGT100A"
SCONfiguration:EXternal:BBMM1:REMOte:ISELect?
// Response: "SGT100A","A"
```

```

SCONfiguration:EXtErnal:BBMM1:REMOte:CONNect

SCONfiguration:EXtErnal:BBMM1:RCONNECTION:STATe?
// Response: 1

SCONfiguration:EXtErnal:BBMM1:INAME?
// Response: "SGT100A [A]"

// Sending SCPI commands directly to the connected external instrument
SCONfiguration:EXtErnal:BBMM1:REMOte:SEND ":SOURcel:FREQuency 2.1GHz"
SCONfiguration:EXtErnal:BBMM1:REMOte:SEND ":SOURcel:FREQuency?"

```

### Example: To configure for 400 MHz fading bandwidth

The following is a simple example to configure a signal with 400 MHz fading bandwidth.

```

:SCONfiguration:MODE ADV
:SCONfiguration:FADing MIMO2x2x2
:SCONfiguration:BBBW BB400
:SCONfiguration:CABW?
// Response: "BB800"
:SCONfiguration:APPLy
:SCONfiguration:FADing MIMO2x2x4
:SCONfiguration:BBBW?
// Response: "BB200"
:SCONfiguration:CABW?
// Response: "BB800"

```

### Example: To enable 1x8x8 MIMO with two R&S SMW200A

In the following, we assume that the two R&S SMW200A are connected and configured as required.

The example uses R&S SGS as RF extensions and the internal baseband signal of the first R&S SMW200A as trigger source for both instruments. If you use a common external trigger source, consider to adapt the proposed configuration.

```

*RST
// Select 8x8 MIMO and set MIMO subset.
:SCONfiguration:MODE ADV
:SCONfiguration:FADing MIMO8X8
:SCONfiguration:MIMO:SUBSet SET1

:SCONfiguration:APPLy
// The instrument generates streams A to D.
// Configure connectors for synchronous baseband triggering.
// Alternatively, use an external common trigger source.
:SOURcel:INPut:USER6:DIRection OUTP
:OUTPut1:USER6:SIGnal MTR

// Configure the fading simulator.
// Enable synchronization of the fading process to the baseband trigger.

```

```

:SOURce1:FSIMulator:REStart:MODE BBTR
:SOURce1:FSIMulator:StAtE 1

// Configure the baseband signal incl. trigger settings.
// Synchronize baseband triggering for an external common trigger source.
// Adapt configuration.
:SOURce1:BB:EUTRa:TRIGger:SEQuence ARET
:SOURce1:BB:EUTRa:TRIGger:SOURce EGT1
:SOURce1:BB:EUTRa:StAtE 1

// Set frequency and level of the RF signal.
:SOURce1:FREQuency:CW 1950000000
:SOURce2:FREQuency:CW 1950000000
:SOURce1:POWEr:POWEr -50
:SOURce2:POWEr:POWEr -50
// Connect and configure the RF extensions, for example, R&S SGS.
:SOURce1:IQ:OUTPut:ANALog:StAtE 1
:SOURce2:IQ:OUTPut:ANALog:StAtE 1

// Activate the IQ and RF outputs.
:SOURce2:IQ:StAtE 1
:SOURce1:IQ:StAtE 1
:OUTPut2:StAtE 1
:OUTPut1:StAtE 1

// Save the configuration.
*SAV 1
:MMEMory:StORe:StAtE 1, "/var/user/8x8_MIMO_Subset1.savrc1.txt"

// Transfer to file to the second instrument
// Load the configuration and change the subset.
:SCONfiguration:MIMO:SUBSet SET2

// Trigger the baseband signal generation and hence the fading process.
:OUTPut1:USER6:TRIGger:IMMediate

```

- [Multi-instrument configuration commands](#)..... 973
- [Baseband and fading configuration commands](#)..... 974
- [I/Q stream mapper commands](#)..... 980
- [External RF and I/Q instruments commands](#)..... 982
- [RF ports alignment commands](#)..... 996

## 14.18.1 Multi-instrument configuration commands

Option: R&S SMW-B9.

The following commands configure multi-instrument settings.

### Commands:

```

:SCONfiguration:MULTIinstrument:MODE..... 974
:SCONfiguration:MULTIinstrument:StAtE..... 974
:SCONfiguration:MULTIinstrument:TRIGger:SYNChronization?..... 974

```

---

**:SCONfiguration:MULTIinstrument:MODE <MSMode>**

Sets if the instrument works as a primary or as a secondary instrument.

**Parameters:**

<MSMode>            PRIMary | SECondary  
\*RST:            PRIMary

**Example:**            See [Example "Configuring primary-secondary mode"](#)  
on page 967.

**Manual operation:**    See ["Multi Instrument Trigger"](#) on page 666

---

**:SCONfiguration:MULTIinstrument:STATE <TriggerState>**

Activates the selected mode.

**Parameters:**

<TriggerState>        1 | ON | 0 | OFF  
\*RST:            0

**Example:**            See [Example "Configuring primary-secondary mode"](#)  
on page 967.

**Manual operation:**    See ["State"](#) on page 666

---

**:SCONfiguration:MULTIinstrument:TRIGger:SYNChronization?**

Queries if synchronization is achieved.

**Return values:**

<SyncState>            SYNC | NOSync  
\*RST:            NOSync

**Example:**            See [Example "Configuring primary-secondary mode"](#)  
on page 967.

**Usage:**                Query only

**Manual operation:**    See ["Synchronisation State"](#) on page 666

---

## 14.18.2 Baseband and fading configuration commands

<a href="#">:SCONfiguration:PRESet</a> .....	975
<a href="#">:SCONfiguration:MODE</a> .....	975
<a href="#">:SCONfiguration:OUTPut:MODE</a> .....	976
<a href="#">:SCONfiguration:FADing</a> .....	976
<a href="#">:SCONfiguration:MIMO:SUBSet</a> .....	977
<a href="#">:SCONfiguration:BASeband:SOURce</a> .....	978
<a href="#">:SCONfiguration:BBBW</a> .....	978
<a href="#">:SCONfiguration:CABW?</a> .....	979
<a href="#">:SCONfiguration:DIQ:BBMM1:CHANnels</a> .....	979

:SCONfiguration:DIQ:BBMM2:CHANnels.....	979
:SCONfiguration:DUPLicate[:STReam].....	980
:SCONfiguration:APPLY.....	980

---

### :SCONfiguration:PRESet

Presets the signal routing in the baseband section and the fading configuration to the default state.

**Example:** See [Example "Distributing the streams to the output connectors"](#) on page 964.

**Usage:** Event

**Manual operation:** See ["Set to Default"](#) on page 126

---

### :SCONfiguration:MODE <Mode>

Switches between the operating modes.

#### Parameters:

<Mode> ADVanced | STANdard | REGenerator | GNSS | ESEQuencer | BWEXtension

#### **ADVanced|STANdard**

Switches between the [Standard mode](#) and [Advanced mode](#).

#### **REGenerator**

Enables the R&S SMW200A to work as a radar echo generator. The fading simulator is disabled.

See the user manual R&S SMW-K78 Radar Echo Generation.

#### **GNSS**

Enables the R&S SMW200A to work in GNSS advanced mode. The fading simulator is disabled.

See the user manual R&S SMW200A Satellite Navigation.

#### **ESEQuencer**

Enables the R&S SMW200A to work in an advanced extended sequencer mode.

The fading simulator, the AWGN, the BB input and all baseband digital standards are disabled.

See user manual R&S SMW-K501/-K502/-K503/-K504/-K315 Extended and Real-Time Sequencing, Real-Time Control Interface, Extended Pulse Rate, Permanent Emitters.

#### **BEXtension**

Enables the R&S SMW200A to generate RF signals with extended bandwidth. These signals typically have bandwidths above 2.4 GHz.

See the user manual R&S SMW-K555 Bandwidth Extension.

\*RST: STANdard

**Example:** See [Example "Distributing the streams to the output connectors"](#) on page 964.

**Options:** REGenerator requires option R&S SMW-K78.  
 GNSS requires option R&S SMW-B9.  
 ESEQuencer requires options R&S SMW-B15/-K315.  
 BEXTension requires options R&S SMW-B9 and R&S SMW-K555.

**Manual operation:** See "[Mode](#)" on page 120

### **:SCONfiguration:OUTPut:MODE <Mode>**

Defines what kind of signal is generated and which output interfaces are enabled.

**Parameters:**

<Mode> DIGMux | DIGital | ALL | ANALog | HSDigital | HSALI

**ALL**  
 Output at the analog (RF and I/Q) and the digital DIG I/Q interfaces.

**DIGital | DIGMux**  
 Signal is output as single stream or multiplexed digital signal at the DIG I/Q interfaces.

**ANALog**  
 Output at the analog (RF and I/Q) interfaces.

**HSDigital**  
 Output at the interfaces HS DIG I/Q interfaces.

**HSALI**  
 Output at the analog (RF and I/Q) and the digital HS DIG I/Q interfaces.

\*RST: ALL

**Example:** `SCONfiguration:OUTPut:MODE ALL`

**Options:** DIGMux requires R&S SMW-K551  
 DIGital requires R&S SMW-K18/-K19  
 ANALog|HSDigital|HSALI require R&S SMW-B9 and R&S SMW-K19

**Manual operation:** See "[Signal Outputs](#)" on page 121

### **:SCONfiguration:FADing <FadConfig>**

Defines the signal routing for standard and advanced system configuration modes. The availability of specific configurations of these modes depends on installed options.

For more information, refer to the specifications document.



<b>:SCONfiguration:MODE</b>	<FadConfig>
STANdard	FAAFBNone   FANFBB   FAAFBB   FAAFBA   FABFBB   FAABFBN   FANFBAB   FAABFBAB
ADVanced	MIMO1X2   MIMO2X2   MIMO2X3   MIMO2X4   MIMO3X2   MIMO3X3   MIMO3X4   MIMO4X2   MIMO4X3   MIMO4X4   MIMO1X8   MIMO8X1   MIMO2X8   MIMO8X2   MIMO2X1   MIMO2X1X2   MIMO2X2X1   MIMO2X1X3   MIMO2X1X4   MIMO2X2X2   MIMO1X3   MIMO3X1   MIMO1X4   MIMO4X1   MIMO3X1X2   MIMO3X2X1   MIMO4X1X2   MIMO3X2X2   MIMO4X2X2   MIMO4X2X1   SISO2X1X1   SISO3X1X1   SISO4X1X1   SISO5X1X1   SISO6X1X1   SISO7X1X1   SISO8X1X1   MIMO2X2X4   MIMO2X4X2   MIMO2X2X3   MIMO2X3X1   MIMO2X3X2   MIMO2X4X1  MIMO4X8   MIMO8X4   MIMO2X4X4   MIMO2X3X3   MIMO2X3X4   MIMO2X4X3  MIMO8X8

**Parameters:**

&lt;FadConfig&gt;

FAAFBNone | FANFBB | FAAFBB | SISO2X1X1 | FAAFBA |  
FABFBB | FAABFBN | FANFBAB | FAABFBAB | MIMO1X2 |  
MIMO2X2 | MIMO2X3 | MIMO2X4 | MIMO3X2 | MIMO3X3 |  
MIMO3X4 | MIMO4X2 | MIMO4X3 | MIMO4X4 | MIMO1X8 |  
MIMO8X1 | MIMO2X8 | MIMO8X2 | MIMO2X1 | MIMO2X1X2 |  
MIMO2X2X1 | MIMO2X2X2 | MIMO1X3 | MIMO3X1 |  
MIMO1X4 | MIMO4X1 | MIMO3X1X2 | MIMO3X2X1 |  
MIMO4X1X2 | MIMO3X2X2 | MIMO4X2X2 | MIMO4X2X1 |  
SISO3X1X1 | SISO4X1X1 | SISO5X1X1 | SISO6X1X1 |  
SISO7X1X1 | SISO8X1X1 | MIMO2X2X4 | MIMO2X4X2 |  
MIMO4X8 | MIMO8X4 | MIMO2X1X3 | MIMO2X1X4 |  
MIMO2X2X3 | MIMO2X3X1 | MIMO2X3X2 | MIMO2X4X1 |  
MIMO2X4X4 | MIMO2X3X3 | MIMO2X3X4 | MIMO2X4X3 |  
MIMO8X8

\*RST: FAAFBB

**Example:**

See [Example "Distributing the streams to the output connectors"](#)  
on page 964.

**Manual operation:**

See ["Signal Routing"](#) on page 122  
See ["Entities \(Users, Cells\)"](#) on page 123  
See ["Basebands \(Tx Antennas\)"](#) on page 123  
See ["Streams \(Rx Antennas\)"](#) on page 124

**:SCONfiguration:MIMO:SUBSet** <SubSet>

Sets the MIMO subset.

While simulating 8x8 or 4x4 MIMO mode with wider fading bandwidth and two R&S SMW200A, the MIMO subset defines which fading channels from the MIMO matrix are calculated by the selected instrument. The MIMO subset selected in each of the two connected instrument has to be different.

**Parameters:**

<Subset> SET2 | SET1 | ALL  
 \*RST: SET1 (R&S SMW200A-B10)/ALL(R&S SMW200A-B9)

**Example:** See [Example "To enable 1x8x8 MIMO with two R&S SMW200A"](#) on page 972.

**Options:** ALL requires R&S SMW200A-B9  
 SET2|SET1 requires R&S SMW-K821/K822.

**Manual operation:** See ["Subset"](#) on page 124

**:SCONfiguration:BASEband:SOURce** <SourConfig>

Determines whether coupled or separated baseband sources are used.

**Parameters:**

<SourConfig> SEParate | COUPlEd | CPENtity  
**SEParate**  
 Enabled in LxMxN configurations with  $L \leq 2$  and  $M < 4$   
**COUPlEd|CPENtity**  
 Enabled in LxMxN configurations with  $L > 2$   
 CPENtity enabled in LxMxN configurations with  $L > 1$  and  $M > 1$ .  
 \*RST: SEParate

**Example:** See [Example "Distributing the streams to the output connectors"](#) on page 964.

**Manual operation:** See ["BB Source Config"](#) on page 125

**:SCONfiguration:BBBW** <Bandwidth>

Sets the bandwidth of the baseband signal at the inputs of the fading simulator.

The available values depend on the selected MIMO configuration.

For example:

- In MIMO configurations with fewer than 8 channels, the max. baseband bandwidth is 400 MHz.
- In MIMO configurations with fewer than 4 channels, the max. baseband bandwidth is 800 MHz.

**Parameters:**

<Bandwidth> BB040 | BB050 | BB080 | BB100 | BB160 | BB200 | BB800 |  
 BB400 | BB500 | BB1G | BB2G | BB120 | BBOUTDEF | BB240  
**BB040|BB050 ...**  
 Bandwidth in MHz, e.g. 40 MHz.

**BB1G|BB2G**

1 GHz, 2 GHz bandwidth.

Available in SISO configurations.

**BBOUTDEF**

Bandwidth determined by the signal at the HS DIG I/Q.

**Example:** See [Example "To configure for 400 MHz fading bandwidth"](#) on page 972.

**Options:** R&S SMW-K822  
BB800 requires R&S SMW-K823

**Manual operation:** See ["BB Bandwidth"](#) on page 124

**:SCONfiguration:CABW?**

Queries the resulting channel aggregation bandwidth, i.e. the signal bandwidth at the outputs of the stream mapper.

The value is calculated automatically and depends on the selected configuration, the installed options and the selected baseband bandwidth (`:SCONfiguration:BBW`).

**Return values:**

<Bandwidth> BB800 | BB200  
\*RST: depends on options

**Example:** See [Example "To configure for 400 MHz fading bandwidth"](#) on page 972.

**Usage:** Query only

**Options:** R&S SMW-K822/K823

**Manual operation:** See ["CA Bandwidth"](#) on page 125

**:SCONfiguration:DIQ:BBMM1:CHANnels** <DigIqHsBBMM1cha>

**:SCONfiguration:DIQ:BBMM2:CHANnels** <DigIqHsBBMM2Cha>

In `:SCONfiguration:OUTPut:MODEHSDigital|HSAL`, sets the number of digital channels on the HS DIG I/Q interface.

The total number of enabled channels on all HS DIG I/Q interface must not exceed 8.

**Parameters:**

<DigIqHsBBMM2Cha>CH0 | CH1 | CH2 | CH3 | CH4 | CH5 | CH6 | CH7 | CH8

**Example:** See [Example "Generating digital signals"](#) on page 968.

**Options:** R&S SMW-K19

**Manual operation:** See ["HS Channels per"](#) on page 126

**:SCONfiguration:DUPLicate[:STReam] <DuplicateStream>**

In a 3x1x1 or 4x1x1 configuration, creates a copy of each stream. Generates are a total number of 6 or 8 streams, where 4 of them can be signals with real-time data source.

**Parameters:**

<DuplicateStream> 1 | ON | 0 | OFF  
\*RST: 0

**Example:**

```
:SCONfiguration:APPLy
:SCONfiguration:MODE ADV
:SCONfiguration:FADing SIS03X1X1
:SCONfiguration:DUPLicate:STReam 1
:SCONfiguration:APPLy
```

**Options:** R&S SMW-K550

**Manual operation:** See ["Duplicate Streams"](#) on page 125

**:SCONfiguration:APPLy**

Assigns and confirms the system configuration settings.

**Example:** See [Example "Distributing the streams to the output connectors"](#) on page 964.

**Usage:** Event

**Manual operation:** See ["Apply"](#) on page 126  
See ["Ok"](#) on page 126

**14.18.3 I/Q stream mapper commands**

Option: R&S SMW-B10 for commands with the keyword `FADer<ch>`.

The following commands configure the I/Q stream mapper.

```
:SCONfiguration:OUTPut:MAPPing:BBMM<ch>:CHANnel<di>:STReam<st>:STATe..... 981
:SCONfiguration:OUTPut:MAPPing:FADer<ch>:STReam<st>:STATe..... 981
:SCONfiguration:OUTPut:MAPPing:RF<ch>:STReam<st>:STATe..... 981
:SCONfiguration:OUTPut:MAPPing:BBMM<ch>:STReam<st>:STATe..... 981
:SCONfiguration:OUTPut:MAPPing:IQOutput<ch>:STReam<st>:STATe..... 981
:SCONfiguration:OUTPut:MAPPing:BBMM<ch>:CHANnel<di>:MODE..... 981
:SCONfiguration:OUTPut:MAPPing:FADer<ch>:MODE..... 981
:SCONfiguration:OUTPut:MAPPing:RF<ch>:MODE..... 981
:SCONfiguration:OUTPut:MAPPing:IQOutput<ch>:MODE..... 981
:SCONfiguration:OUTPut:MAPPing:BBMM<ch>:MODE..... 981
:SCONfiguration:OUTPut:MAPPing:STReam<st>:FOFFset..... 981
:SCONfiguration:OUTPut:MAPPing:STReam<st>:POFFset..... 982
```

---

```

:SCONfiguration:OUTPut:MAPPING:BBMM<ch>:CHANnel<di>:STReam<st>:
  STATE <State>
:SCONfiguration:OUTPut:MAPPING:FADer<ch>:STReam<st>:STATE <State>
:SCONfiguration:OUTPut:MAPPING:RF<ch>:STReam<st>:STATE <State>
:SCONfiguration:OUTPut:MAPPING:BBMM<ch>:STReam<st>:STATE <State>
:SCONfiguration:OUTPut:MAPPING:IQOutput<ch>:STReam<st>:STATE <State>

```

Maps the I/Q output streams to the output connectors.

The stream mapping to the FADER connectors is fixed.

**Parameters:**

```

<State>          1 | ON | 0 | OFF
                 *RST:      0

```

**Example:** See [Example "Distributing the streams to the output connectors"](#) on page 964.

**Manual operation:** See ["Map Stream X to Connector"](#) on page 128

---

```

:SCONfiguration:OUTPut:MAPPING:BBMM<ch>:CHANnel<di>:MODE <Mode>
:SCONfiguration:OUTPut:MAPPING:FADer<ch>:MODE <Mode>
:SCONfiguration:OUTPut:MAPPING:RF<ch>:MODE <Mode>
:SCONfiguration:OUTPut:MAPPING:IQOutput<ch>:MODE <Mode>
:SCONfiguration:OUTPut:MAPPING:BBMM<ch>:MODE <Mode>

```

Enables routing of multiple streams to the same output physical connector and defines the way the streams are internally processed.

**Parameters:**

```

<Mode>          SINGle | ADD | MULTiplex
                 ADD enabled for the RF, I/Q OUT and BBMM outputs
                 MULTiplex enabled for the BBMM outputs and
                 :SCONfiguration:OUTPut:MODEDIGMux
                 *RST:      SINGle

```

**Example:** See [Example "Distributing the streams to the output connectors"](#) on page 964.

See [Example "Generating digital multiplexed signals"](#) on page 968.

**Options:** ADD requires R&S SMW-B10  
MULTiplex requires R&S SMW-K551

**Manual operation:** See ["Combination Mode"](#) on page 129

---

```

:SCONfiguration:OUTPut:MAPPING:STReam<st>:FOFFset <SmFreqOffset>

```

For wideband instruments (R&S SMW-B9), this settings requires analog signal outputs:  
SCONfiguration:OUTPut:MODE ANAL

Sets the frequency offset per stream.

This offset implies a shift in the frequency domain for all signals that the stream routes to a specific output connector. For example, RF or I/Q output connectors. Value ranges depend on installed options.

For more information, refer to the specifications document.

**Parameters:**

<SmFreqOffset> float  
 Range: depends on options  
 Increment: 0.01  
 \*RST: 0

**Example:** See [Example "Distributing the streams to the output connectors"](#) on page 964.

**Manual operation:** See "[f<sub>offset</sub>, MHz](#)" on page 127

**:SCONfiguration:OUTPut:MAPPING:STReam<st>:POFFset <SmPhasOffset>**

For wideband instruments (R&S SMW-B9), this settings requires analog signal outputs:  
 SCONfiguration:OUTPut:MODE ANAL

Sets the phase offset per stream.

**Parameters:**

<SmPhasOffset> float  
 Range: -999.99 to 999.99  
 Increment: 0.01  
 \*RST: 0

**Example:** See [Example "Distributing the streams to the output connectors"](#) on page 964.

**Manual operation:** See "[Phase Offset](#)" on page 128

## 14.18.4 External RF and I/Q instruments commands

The following commands configure external RF and I/Q instruments.



**Available SCPI commands depending on the installed options and system configuration**

- Option: R&S SMW-B10  
 Required for commands with the keyword `FADer<ch>`
- Option: R&S SMW-B9  
 See [Section 4.3.4, "Supported digital interfaces and system configuration"](#), on page 113 for information if the commands with keywords `BBMM<ch>` and `CODer<ch>` are supported in the current system configuration.

**Commands:**

:SCONfiguration:EXternal:DISPlay.....	984
:SCONfiguration:EXternal:ACONnect.....	985
:SCONfiguration:EXternal:REMOte:CONNect[:ALL].....	985
:SCONfiguration:EXternal:REMOte:DISConnect[:ALL].....	985
:SCONfiguration:EXternal:PBEHaviour.....	985
:SCONfiguration:EXternal:CODer<ch>:DIRection?.....	986
:SCONfiguration:EXternal:FADer<ch>:DIRection?.....	986
:SCONfiguration:EXternal:BBMM<ch>:DIRection?.....	986
:SCONfiguration:EXternal:RF<ch>:DIRection?.....	986
:SCONfiguration:EXternal:IQOutput<ch>:DIRection?.....	986
:SCONfiguration:EXternal:CODer<ch>:IQConnection:STATe?.....	987
:SCONfiguration:EXternal:FADer<ch>:IQConnection:STATe?.....	987
:SCONfiguration:EXternal:BBMM<ch>:IQConnection:STATe?.....	987
:SCONfiguration:EXternal:CODer<ch>:RCONnection:STATe?.....	987
:SCONfiguration:EXternal:FADer<ch>:RCONnection:STATe?.....	987
:SCONfiguration:EXternal:BBMM<ch>:RCONnection:STATe?.....	987
:SCONfiguration:EXternal:RF<ch>:RCONnection:STATe?.....	987
:SCONfiguration:EXternal:IQOutput<ch>:RCONnection:STATe?.....	987
:SCONfiguration:EXternal:CODer<ch>:INAMe?.....	987
:SCONfiguration:EXternal:FADer<ch>:INAMe?.....	987
:SCONfiguration:EXternal:BBMM<ch>:INAMe?.....	987
:SCONfiguration:EXternal:RF<ch>:INAMe?.....	987
:SCONfiguration:EXternal:IQOutput<ch>:INAMe?.....	987
:SCONfiguration:EXternal:FADer<ch>:RF:COUPling.....	988
:SCONfiguration:EXternal:BBMM<ch>:RF:COUPling.....	988
:SCONfiguration:EXternal:RF<ch>:RF:COUPling.....	988
:SCONfiguration:EXternal:IQOutput<ch>:RF:COUPling.....	988
:SCONfiguration:EXternal:FADer<ch>:RF:FREQuency.....	988
:SCONfiguration:EXternal:BBMM<ch>:RF:FREQuency.....	988
:SCONfiguration:EXternal:RF<ch>:RF:FREQuency.....	988
:SCONfiguration:EXternal:IQOutput<ch>:RF:FREQuency.....	988
:SCONfiguration:EXternal:FADer<ch>:RF:FREQuency:OFFSet.....	988
:SCONfiguration:EXternal:BBMM<ch>:RF:FREQuency:OFFSet.....	988
:SCONfiguration:EXternal:RF<ch>:RF:FREQuency:OFFSet.....	988
:SCONfiguration:EXternal:IQOutput<ch>:RF:FREQuency:OFFSet.....	988
:SCONfiguration:EXternal:FADer<ch>:RF:POWer.....	989
:SCONfiguration:EXternal:BBMM<ch>:RF:POWer.....	989
:SCONfiguration:EXternal:RF<ch>:RF:POWer.....	989
:SCONfiguration:EXternal:IQOutput<ch>:RF:POWer.....	989
:SCONfiguration:EXternal:FADer<ch>:RF:POWer:OFFSet.....	989
:SCONfiguration:EXternal:BBMM<ch>:RF:POWer:OFFSet.....	989
:SCONfiguration:EXternal:RF<ch>:RF:POWer:OFFSet.....	989
:SCONfiguration:EXternal:IQOutput<ch>:RF:POWer:OFFSet.....	989
:SCONfiguration:EXternal:FADer<ch>:RF:STATe.....	990
:SCONfiguration:EXternal:BBMM<ch>:RF:STATe.....	990
:SCONfiguration:EXternal:RF<ch>:RF:STATe.....	990
:SCONfiguration:EXternal:IQOutput<ch>:RF:STATe.....	990
:SCONfiguration:EXternal:REMOte:SCAN.....	990

:SCONfiguration:EXternal:REMOte:SCAN:STATe?	990
:SCONfiguration:EXternal:REMOte:LIST?	991
:SCONfiguration:EXternal:REMOte:ADD	991
:SCONfiguration:EXternal:REMOte:REName	992
:SCONfiguration:EXternal:CODeR<ch>:REMOte:DETEct?	992
:SCONfiguration:EXternal:FADer<ch>:REMOte:DETEct?	992
:SCONfiguration:EXternal:BBMM<ch>:REMOte:DETEct?	992
:SCONfiguration:EXternal:CODeR<ch>:REMOte:ISELect	992
:SCONfiguration:EXternal:FADer<ch>:REMOte:ISELect	992
:SCONfiguration:EXternal:BBMM<ch>:REMOte:ISELect	992
:SCONfiguration:EXternal:IQOutput<ch>:REMOte:ISELect	992
:SCONfiguration:EXternal:RF<ch>:REMOte:ISELect	992
:SCONfiguration:EXternal:CODeR<ch>:REMOte:CONNEct	993
:SCONfiguration:EXternal:FADer<ch>:REMOte:CONNEct	993
:SCONfiguration:EXternal:BBMM<ch>:REMOte:CONNEct	993
:SCONfiguration:EXternal:IQOutput<ch>:REMOte:CONNEct	993
:SCONfiguration:EXternal:RF<ch>:REMOte:CONNEct	993
:SCONfiguration:EXternal:CODeR<ch>:REMOte:ICONNEct	993
:SCONfiguration:EXternal:FADer<ch>:REMOte:ICONNEct	993
:SCONfiguration:EXternal:BBMM<ch>:REMOte:ICONNEct	993
:SCONfiguration:EXternal:IQOutput<ch>:REMOte:ICONNEct	993
:SCONfiguration:EXternal:RF<ch>:REMOte:ICONNEct	993
:SCONfiguration:EXternal:CODeR<ch>:REMOte:INFO?	993
:SCONfiguration:EXternal:FADer<ch>:REMOte:INFO?	993
:SCONfiguration:EXternal:BBMM<ch>:REMOte:INFO?	993
:SCONfiguration:EXternal:RF<ch>:REMOte:INFO?	994
:SCONfiguration:EXternal:IQOutput<ch>:REMOte:INFO?	994
:SCONfiguration:EXternal:CODeR<ch>:REMOte:DISCONNEct	994
:SCONfiguration:EXternal:FADer<ch>:REMOte:DISCONNEct	994
:SCONfiguration:EXternal:BBMM<ch>:REMOte:DISCONNEct	994
:SCONfiguration:EXternal:RF<ch>:REMOte:DISCONNEct	994
:SCONfiguration:EXternal:IQOutput<ch>:REMOte:DISCONNEct	994
:SCONfiguration:EXternal:REMOte:INITIALIZation:CATalog?	994
:SCONfiguration:EXternal:CODeR<ch>:REMOte:INITIALIZation:FILE	995
:SCONfiguration:EXternal:FADer<ch>:REMOte:INITIALIZation:FILE	995
:SCONfiguration:EXternal:BBMM<ch>:REMOte:INITIALIZation:FILE	995
:SCONfiguration:EXternal:RF<ch>:REMOte:INITIALIZation:FILE	995
:SCONfiguration:EXternal:IQOutput<ch>:REMOte:INITIALIZation:FILE	995
:SCONfiguration:EXternal:REMOte:PURGe	995
:SCONfiguration:EXternal:REMOte:CLEan	995
:SCONfiguration:EXternal:CODeR<ch>:REMOte:SEND	995
:SCONfiguration:EXternal:FADer<ch>:REMOte:SEND	995
:SCONfiguration:EXternal:BBMM<ch>:REMOte:SEND	995
:SCONfiguration:EXternal:RF<ch>:REMOte:SEND	995
:SCONfiguration:EXternal:IQOutput<ch>:REMOte:SEND	995
:SCONfiguration:EXternal:IQOutput<ch>:CONNEctions:CHECK?	996

---

**:SCONfiguration:EXternal:DISPlay <DisplayMode>**

Filters the displayed connectors upon the selected criteria.



**Parameters:**

<DisplayMode> ALL | MAPPed | INPut | OUTPut  
 \*RST: MAPPed

**Example:** See [Example "Connecting and configuring external instruments"](#) on page 965.

**Manual operation:** See ["Display"](#) on page 131

**:SCONfiguration:EXTErnal:ACONnect <State>**

Enables automatic detection and connection setup of connected external instruments.

**Parameters:**

<State> 1 | ON | 0 | OFF  
 \*RST: 0

**Example:** See [Example "Distributing the streams to the output connectors"](#) on page 964.

**Manual operation:** See ["Auto Connect"](#) on page 131

**:SCONfiguration:EXTErnal:REMOte:CONNect[:ALL]****:SCONfiguration:EXTErnal:REMOte:DISConnect[:ALL]**

Triggers the instrument to establish the connections to all configured external instruments or to disconnect all existing connections.

**Example:** See [Example "Connecting and configuring external instruments"](#) on page 965.

**Usage:** Event

**Manual operation:** See ["Connect/Disconnect All Remote"](#) on page 131

**:SCONfiguration:EXTErnal:PBEHaviour <State>**

If enabled, the connection to the external instruments is retained after preset (\*RST) of the instrument.

**Parameters:**

<State> 1 | ON | 0 | OFF  
 \*RST: n.a. (factory preset: 0)

**Example:**

```

SCONfiguration:EXTErnal:IQOutput1:INAME?
// "SZU (999991) B1066"

SCONfiguration:EXTErnal:IQOutput1:RCONnection:STATE?
// 1
SOURCE:FREQuency:CW?
// 60000000000
SOURCE1:IQ:OUTPup:ANALog:TYPE DIFFerential

SCONfiguration:EXTErnal:PBEHaviour 1
*RST
SOURCE:FREQuency:CW?
// 60000000000
SCONfiguration:EXTErnal:IQOutput1:RCONnection:STATE?
// 1
SOURCE1:IQ:OUTPup:ANALog:TYPE?
// DIFF

SCONfiguration:EXTErnal:PBEHaviour 0
*RST
SOURCE:FREQuency:CW?
// 10000000000
SCONfiguration:EXTErnal:IQOutput1:RCONnection:STATE?
// 0
SOURCE1:IQ:OUTPut:ANALog:TYPE?
// SING

```

**Manual operation:** See ["Preset behavior: Keep connections to external instruments"](#) on page 132

---

```

:SCONfiguration:EXTErnal:CODer<ch>:DIRection?
:SCONfiguration:EXTErnal:FADer<ch>:DIRection?
:SCONfiguration:EXTErnal:BBMM<ch>:DIRection?
:SCONfiguration:EXTErnal:RF<ch>:DIRection?
:SCONfiguration:EXTErnal:IQOutput<ch>:DIRection?

```

Queries the connector direction.

**Return values:**

```

<Direction>      NONE | IN | OUT
*RST:            IN

```

**Example:** See [Example "Connecting and configuring external instruments"](#) on page 965.

**Usage:** Query only

**Manual operation:** See ["Direction"](#) on page 132

---

```
:SCONfiguration:EXTernal:CODer<ch>:IQConnection:STATe?
:SCONfiguration:EXTernal:FADer<ch>:IQConnection:STATe?
:SCONfiguration:EXTernal:BBMM<ch>:IQConnection:STATe?
```

Queries the status of the I/Q connection of the digital interfaces.

**Return values:**

<IQConnState> 1 | ON | 0 | OFF

**Example:** See [Example "Connecting and configuring external instruments"](#) on page 965.

**Usage:** Query only

**Manual operation:** See ["I/Q Connection"](#) on page 133  
See ["RF State"](#) on page 135

---

```
:SCONfiguration:EXTernal:CODer<ch>:RCONnection:STATe?
:SCONfiguration:EXTernal:FADer<ch>:RCONnection:STATe?
:SCONfiguration:EXTernal:BBMM<ch>:RCONnection:STATe?
:SCONfiguration:EXTernal:RF<ch>:RCONnection:STATe?
:SCONfiguration:EXTernal:IQOutput<ch>:RCONnection:STATe?
```

Queries the status of the remote connection.

**Return values:**

<State> 1 | ON | 0 | OFF

**Example:** See [Example "Connecting and configuring external instruments"](#) on page 965.

**Usage:** Query only

**Manual operation:** See ["Remote Connection Status"](#) on page 133

---

```
:SCONfiguration:EXTernal:CODer<ch>:INAMe?
:SCONfiguration:EXTernal:FADer<ch>:INAMe?
:SCONfiguration:EXTernal:BBMM<ch>:INAMe?
:SCONfiguration:EXTernal:RF<ch>:INAMe?
:SCONfiguration:EXTernal:IQOutput<ch>:INAMe?
```

Queries the name of the connected external instrument.

**Return values:**

<InstrName> string

Returns the name of the connected external instrument.

**<InstrmentName> (SerialNumber) <Path>**

the instrument name, as retrieved via the DIG I/Q interface

**<InstrmentName>[, <RfPath>] or <InstrmentName> (Serial-Number)**

the instrument name, as defined in with the "Remote Config" settings or as defined by the command `:SCONfiguration:`

`EXTernal:REMOte:ADD`

**Example:** See [Example "Connecting and configuring external instruments"](#) on page 965.

**Usage:** Query only

**Manual operation:** See ["Instrument Name"](#) on page 134

```
:SCONfiguration:EXTernal:FADer<ch>:RF:COUPling <RfCouplingState>
:SCONfiguration:EXTernal:BBMM<ch>:RF:COUPling <RfCouplingState>
:SCONfiguration:EXTernal:RF<ch>:RF:COUPling <RfCouplingState>
:SCONfiguration:EXTernal:IQOutput<ch>:RF:COUPling <RfCouplingState>
```

Enables/disables coupling all major RF setting (like the frequency, level and RF state) of the external instrument to the R&S SMW200A.

**Parameters:**

```
<RfCouplingState> 1 | ON | 0 | OFF
*RST: 1
```

**Example:** See [Example "Connecting and configuring external instruments"](#) on page 965.

**Manual operation:** See ["RF Couple"](#) on page 134

```
:SCONfiguration:EXTernal:FADer<ch>:RF:FREQUency <Frequency>
:SCONfiguration:EXTernal:BBMM<ch>:RF:FREQUency <Frequency>
:SCONfiguration:EXTernal:RF<ch>:RF:FREQUency <Frequency>
:SCONfiguration:EXTernal:IQOutput<ch>:RF:FREQUency <Frequency>
```

In uncoupled mode, sets the RF frequency of the external instrument.

**Parameters:**

```
<Frequency> float
Range: 100E3 to 3E9
Increment: 0.01
*RST: 1E9
```

**Example:**

```
SCONfiguration:EXTernal:IQOutput1:RF:COUPling OFF
SCONfiguration:EXTernal:IQOutput1:RF:FREQUency 2143E6
// RF frequency of the external instrument is RF = 2.143 GHz
```

**Manual operation:** See ["\(Delta\) RF Frequency/ RF Level"](#) on page 135

```
:SCONfiguration:EXTernal:FADer<ch>:RF:FREQUency:OFFSet <FreqOffset>
:SCONfiguration:EXTernal:BBMM<ch>:RF:FREQUency:OFFSet <FreqOffset>
:SCONfiguration:EXTernal:RF<ch>:RF:FREQUency:OFFSet <FreqOffset>
:SCONfiguration:EXTernal:IQOutput<ch>:RF:FREQUency:OFFSet <FreqOffset>
```

In coupled mode, offsets the RF frequency of the external instrument with the selected delta value.

**Parameters:**

<FreqOffset> float  
 Range: -3E9 to 3E9  
 Increment: 0.01  
 \*RST: 0

**Example:**

```
SOURce1:FREQuency:CW 2143E6
SCONfiguration:EXTernal:IQOutput1:RF:COUPling ON
SCONfiguration:EXTernal:IQOutput1:RF:FREQuency:OFFSet 20E6
// The resulting RF frequency of the external instrument is
// RF = 2143E6 + 20E6 = 2.163 GHz
// Where both the RF frequency and the frequency offset
// are applied at the external instrument
```

**Manual operation:** See "[\(Delta\) RF Frequency/ RF Level](#)" on page 135

```
:SCONfiguration:EXTernal:FADer<ch>:RF:POWer <Power>
:SCONfiguration:EXTernal:BBMM<ch>:RF:POWer <Power>
:SCONfiguration:EXTernal:RF<ch>:RF:POWer <Power>
:SCONfiguration:EXTernal:IQOutput<ch>:RF:POWer <Power>
```

In uncoupled mode, sets the RF level of the external instrument.

**Parameters:**

<Power> float  
 Range: -130 to 20  
 Increment: 0.01  
 \*RST: -30

**Example:**

```
SOURce1:POWer:LEVel:IMMediate:AMPLitude -30
SCONfiguration:EXTernal:IQOutput1:RF:COUPling OFF
SCONfiguration:EXTernal:IQOutput1:RF:POWer -20
// RF level of the external instrument is -20 dB
```

**Manual operation:** See "[\(Delta\) RF Frequency/ RF Level](#)" on page 135

```
:SCONfiguration:EXTernal:FADer<ch>:RF:POWer:OFFSet <PowerOffset>
:SCONfiguration:EXTernal:BBMM<ch>:RF:POWer:OFFSet <PowerOffset>
:SCONfiguration:EXTernal:RF<ch>:RF:POWer:OFFSet <PowerOffset>
:SCONfiguration:EXTernal:IQOutput<ch>:RF:POWer:OFFSet <PowerOffset>
```

In coupled mode, offsets the RF level of the external instrument with the selected delta value.

**Parameters:**

<PowerOffset> float  
 Range: -100 to 100  
 Increment: 0.01  
 \*RST: 0

**Example:**

```
SOURcel:POWer:LEVel:IMMediate:AMPLitude -30
SCONfiguration:EXTernal:IQOutput1:RF:COUPling ON
SCONfiguration:EXTernal:IQOutput1:RF:POWer:OFFSet -20
// RF level of the external instrument is -50 dB
// Where both the RF level and the level offset
// are applied at the external instrument
```

**Manual operation:** See "(Delta) RF Frequency/ RF Level" on page 135

```
:SCONfiguration:EXTernal:FADer<ch>:RF:STATe <RemConnState>
:SCONfiguration:EXTernal:BBMM<ch>:RF:STATe <RemConnState>
:SCONfiguration:EXTernal:RF<ch>:RF:STATe <RemConnState>
:SCONfiguration:EXTernal:IQOutput<ch>:RF:STATe <RemConnState>
```

Sets the RF output state of the connected external instrument.

**Parameters:**

<RemConnState> 1 | ON | 0 | OFF

**Example:**

```
SCONfiguration:EXTernal:IQOutput1:RF:COUPling ON
OUTput1:STATe ON
SCONfiguration:EXTernal:IQOutput1:RF:STATe?
// Response: "1"
```

**Example:**

```
SCONfiguration:EXTernal:BBMM1:RF:COUPling OFF
SCONfiguration:EXTernal:BBMM1:RF:STATe ON
```

**Example:** See [Example "Connecting and configuring external instruments"](#) on page 965.

**Manual operation:** See "RF State" on page 135

```
:SCONfiguration:EXTernal:REMote:SCAN
```

Scans the network for connected instruments.

**Example:** See [Example "Connecting and configuring external instruments"](#) on page 965.

**Usage:** Event

**Manual operation:** See "Scan" on page 137

```
:SCONfiguration:EXTernal:REMote:SCAN:STATe?
```

Queries if scanning is performed or not.

To start the scanning process, use the command `:SCONfiguration:EXTernal:REMote:SCAN` on page 990.

**Return values:**

<ScanState> 1 | ON | 0 | OFF  
**1**  
 Scanning process running

**0**

Not scanning

**Example:** See [Example "Connecting and configuring external instruments"](#) on page 965.

**Usage:** Query only

**Manual operation:** See ["Scan"](#) on page 137

### **:SCONfiguration:EXTernal:REMOte:LIST?**

Lists all available instruments.

Instruments found, e.g. by the `:SCONfiguration:EXTernal:REMOte:SCAN` command.

**Return values:**

<InstrNames> String  
String with symbolic names and/or alias names

**Example:** See [Example "Connecting and configuring external instruments"](#) on page 965

**Usage:** Query only

**Manual operation:** See ["External Instrument"](#) on page 138

### **:SCONfiguration:EXTernal:REMOte:ADD** <InstrName>, <HwChan>, <TcplporUsbAddr>[, <RfPathNumber>]

Adds manually an external instrument to the list of available instruments.

**Parameters:**

<HwChan> String  
Hardware channel (USB or LAN) used by the remote channel to the external instrument  
Range: "LAN" to "USB"  
\*RST: "LAN"

<TcplporUsbAddr> String  
IP address or hostname of the connected external instrument

<RfPathNumber> String  
Determines the number of RF paths the external instrument is equipped with  
Range: "1" to "2"  
\*RST: "1"

**Setting parameters:**

<InstrName> String  
Alias name of the instrument

<b>Example:</b>	See <a href="#">Example "Connecting and configuring external instruments"</a> on page 965.
<b>Usage:</b>	Setting only
<b>Manual operation:</b>	See <a href="#">"External Instrument"</a> on page 138 See <a href="#">"Set Symbolic Name"</a> on page 138 See <a href="#">"Remote Channel"</a> on page 138 See <a href="#">"Hostname or IP Address"</a> on page 139 See <a href="#">"Device ID"</a> on page 139 See <a href="#">"RF Path"</a> on page 140

---

**:SCONfiguration:EXTErnal:REMOte:REName**

Changes the symbolic name of the instrument.

<b>Example:</b>	See <a href="#">Example "Connecting and configuring external instruments"</a> on page 965.
<b>Usage:</b>	Setting only

---

**:SCONfiguration:EXTErnal:CODeR<ch>:REMOte:DETEct?**  
**:SCONfiguration:EXTErnal:FADer<ch>:REMOte:DETEct?**  
**:SCONfiguration:EXTErnal:BBMM<ch>:REMOte:DETEct?**

Searches for external instruments connected to the particular digital interfaces.

**Return values:**

<DetectedInstr>	string
	If the detection fails, the query returns "None".

<b>Example:</b>	See <a href="#">Example "Connecting and configuring external instruments"</a> on page 965.
<b>Usage:</b>	Query only
<b>Manual operation:</b>	See <a href="#">"Detect"</a> on page 137

---

**:SCONfiguration:EXTErnal:CODeR<ch>:REMOte:ISELect <InstrName>[, <RfPath>]**  
**:SCONfiguration:EXTErnal:FADer<ch>:REMOte:ISELect <InstrName>[, <RfPath>]**  
**:SCONfiguration:EXTErnal:BBMM<ch>:REMOte:ISELect <InstrName>[, <RfPath>]**  
**:SCONfiguration:EXTErnal:IQOutput<ch>:REMOte:ISELect <InstrName>[, <RfPath>]**  
**:SCONfiguration:EXTErnal:RF<ch>:REMOte:ISELect <InstrName>[, <RfPath>]**

Selects an external instrument for the selected connector.

**Parameters:**

<InstrName>	String
	Instrument alias name, as retrieved with the command : <a href="#">SCONfiguration:EXTErnal:REMOte:LIST?</a> .
	The name can also be defined with the command : <a href="#">SCONfiguration:EXTErnal:REMOte:ADD</a> .



<RfPath> String  
Determines the used RF output of the external instrument.

**Manual operation:** See ["External Instrument"](#) on page 138  
See ["Apply"](#) on page 141  
See ["Apply and Connect"](#) on page 142

```
:SCONfiguration:EXTernal:CODer<ch>:REMote:CONNect
:SCONfiguration:EXTernal:FADer<ch>:REMote:CONNect
:SCONfiguration:EXTernal:BBMM<ch>:REMote:CONNect
:SCONfiguration:EXTernal:IQOutput<ch>:REMote:CONNect
:SCONfiguration:EXTernal:RF<ch>:REMote:CONNect
```

Triggers the connection to the external instrument at the selected connector.

**Example:** See [Example "Connecting and configuring external instruments"](#) on page 965.

**Usage:** Event

**Manual operation:** See ["Apply and Connect"](#) on page 142

```
:SCONfiguration:EXTernal:CODer<ch>:REMote:ICONnect <InstrName>, <RfPath>
:SCONfiguration:EXTernal:FADer<ch>:REMote:ICONnect <InstrName>, <RfPath>
:SCONfiguration:EXTernal:BBMM<ch>:REMote:ICONnect <InstrName>, <RfPath>
:SCONfiguration:EXTernal:IQOutput<ch>:REMote:ICONnect <InstrName>,
  <RfPath>
:SCONfiguration:EXTernal:RF<ch>:REMote:ICONnect <InstrName>, <RfPath>
```

Selects an external instrument for the selected connector and triggers connection.

**Parameters:**

<InstrName> string  
Instrument alias name, as retrieved with the command :  
[SCONfiguration:EXTernal:REMote:LIST?](#).  
The name can also be defined with the command :  
[SCONfiguration:EXTernal:REMote:ADD](#).

<RfPath> string  
Determines the used RF output of the external instrument.

**Example:** See [Example "Connecting and configuring external instruments"](#) on page 965.

**Usage:** Setting only

```
:SCONfiguration:EXTernal:CODer<ch>:REMote:INFO?
:SCONfiguration:EXTernal:FADer<ch>:REMote:INFO?
:SCONfiguration:EXTernal:BBMM<ch>:REMote:INFO?
```

**:SCONfiguration:EXTernal:RF<ch>:REMote:INFO?**

**:SCONfiguration:EXTernal:IQOutput<ch>:REMote:INFO?**

Queries information on the external instrument.

**Example:**

```
SCONfiguration:EXTernal:BBMM1:REMote:INFO?
"SGT (101676)", "LAN", "rsgt100a101676", "A",
"Rohde&Schwarz,SGT100A,1419.4501k02/101676,3.1.19.4-3.18.251.99"
```

**Example:**

See [Example "Connecting and configuring external instruments"](#) on page 965.

**Usage:**

Query only

**Manual operation:**

See ["Remote Connection Status"](#) on page 133  
 See ["Instrument Name"](#) on page 134  
 See ["Set Symbolic Name"](#) on page 138  
 See ["Remote Channel"](#) on page 138  
 See ["Hostname or IP Address"](#) on page 139  
 See ["RF Path"](#) on page 140

**:SCONfiguration:EXTernal:CODer<ch>:REMote:DISConnect**

**:SCONfiguration:EXTernal:FADer<ch>:REMote:DISConnect**

**:SCONfiguration:EXTernal:BBMM<ch>:REMote:DISConnect**

**:SCONfiguration:EXTernal:RF<ch>:REMote:DISConnect**

**:SCONfiguration:EXTernal:IQOutput<ch>:REMote:DISConnect**

Disconnects the selected remote connection.

To disconnect all remote connections at once, use the command `:SCONfiguration:EXTernal:REMote:DISConnect[:ALL]`.

**Example:**

See [Example "Connecting and configuring external instruments"](#) on page 965.

**Usage:**

Event

**Manual operation:**

See ["Remote Connection Status"](#) on page 133

**:SCONfiguration:EXTernal:REMote:INITialization:CATalog?**

Queries the names of the existing initialization files in the default directory.

Per default, the instrument saves user-defined files in the `/var/user/` directory. Use the command `:MMEM:CDIRectory` to change the default directory to the currently used one.

Only files with extension `*.iec` are listed.

**Example:**

See [Example "Connecting and configuring external instruments"](#) on page 965.

**Usage:**

Query only

**Manual operation:**

See ["Initialization Sequence"](#) on page 141

---

```

:SCONfiguration:EXtErnal:CODeR<ch>:REMOte:INITIALIZATION:FILE <Filename>
:SCONfiguration:EXtErnal:FADeR<ch>:REMOte:INITIALIZATION:FILE <Filename>
:SCONfiguration:EXtErnal:BBMM<ch>:REMOte:INITIALIZATION:FILE <Filename>
:SCONfiguration:EXtErnal:RF<ch>:REMOte:INITIALIZATION:FILE <Filename>
:SCONfiguration:EXtErnal:IQOutput<ch>:REMOte:INITIALIZATION:FILE <Filename>

```

Queries the currently selected initialization file.

**Parameters:**

<Filename>                    string  
                                   filename with file extension (\*.iec)

**Example:**                    See [Example "Connecting and configuring external instruments"](#) on page 965.

**Manual operation:**        See ["Initialization Sequence"](#) on page 141

---

**:SCONfiguration:EXtErnal:REMOte:PURGe**

Removes unused instruments from the pool of external instruments.

**Example:**                    See [Example "Connecting and configuring external instruments"](#) on page 965.

**Usage:**                        Event

**Manual operation:**        See ["Clean Unused/Clean All"](#) on page 137

---

**:SCONfiguration:EXtErnal:REMOte:CLEan**

Removes all instruments from the pool of external instruments.

**Example:**                    See [Example "Connecting and configuring external instruments"](#) on page 965.

**Usage:**                        Event

**Manual operation:**        See ["Clean Unused/Clean All"](#) on page 137

---

```

:SCONfiguration:EXtErnal:CODeR<ch>:REMOte:SEND <SendScpiCommand>
:SCONfiguration:EXtErnal:FADeR<ch>:REMOte:SEND <SendScpiCommand>
:SCONfiguration:EXtErnal:BBMM<ch>:REMOte:SEND <SendScpiCommand>
:SCONfiguration:EXtErnal:RF<ch>:REMOte:SEND <SendScpiCommand>
:SCONfiguration:EXtErnal:IQOutput<ch>:REMOte:SEND <SendScpiCommand>

```

Allows you to send SCPI commands to the RF instruments connected to the R&S SMW200A.

**Setting parameters:**

<SendScpiCommand>"<SCPI syntax>"  
                                   String containing an SCPI command (query or setting)

**Example:**                    See [Section 14.18, "SCONfiguration subsystem"](#), on page 963.

**Usage:** Setting only

**Manual operation:** See "[Command/Send Command](#)" on page 143

---

#### **:SCONfiguration:EXTernal:IQOutput<ch>:CONNections:CHECK?**

Queries the status of the required connections between the R&S SMW200A and the R&S SZU.

R&S SZU is connected to the R&S SMW200A via USB.

**Example:**

```
SCONfiguration:EXTernal:IQOutput1:REMOte:ISElect "SZU (999991) B1066"
SOURCE1:IQ:OUTPut:ANALog:TYPE SING
SCONfiguration:EXTernal:IQOutput1:REMOte:CONNECT
SCONfiguration:EXTernal:ACONnect 1
SCONfiguration:EXTernal:PBEHaviour 1

SCONfiguration:EXTernal:IQOutput1:REMOte:INFO?
// "SZU (999991) B1066","USB (vendor specific)","999991","A"

SOURCE1:FREQuency:CONVerter:EXTernal:CHECK:CONNections?
// Passed,Failed,Unused,Failed,Unused,Passed
// The R&S SZU is connected to the R&S SMW
// The USB and the RF A to LO In connections are correct
// There is a failure in the single-ended I/Q connection
// (between the I/Q OUT and the I/Q IN connectors)
```

**Usage:** Query only

**Manual operation:** See "[Check Connections](#)" on page 145

### 14.18.5 RF ports alignment commands

Option: R&S SMW-B9 and R&S SMW-K545

#### **Commands:**

#### **Example: Loading and activating setup files**

This example uses the predefined demo setup file.

```
// SCONfiguration:RFAlignment:SETup:CATalog?
// SCONfiguration:RFAlignment:SETup:FILE "/var/user/RfPortsSetup/setup"

SCONfiguration:RFAlignment:SETup:PREDefined:CATalog?
// demo
SCONfiguration:RFAlignment:SETup:FILE:PREDefined "demo"
SCONfiguration:RFAlignment:SETup:STATus?
// NALign
SCONfiguration:RFAlignment:ALIGN
SCONfiguration:RFAlignment:SETup:STATus?
// ALIGNed
SCONfiguration:RFAlignment:STATe 1
```

**Example: Retrieving details on the calibrated values**

This example uses the predefined demo setup file.

```
SCONfiguration:RFALignment:SETup:PREDefined:CATalog?
// demo
SCONfiguration:RFALignment:SETup:FILE:PREDefined "demo"

SCONfiguration:RFALignment:SETup:INFO:CALibration:DATE?
// "2019-01-11"
SCONfiguration:RFALignment:SETup:INFO:CALibration:TIME?
// "08:15:37 "
SCONfiguration:RFALignment:SETup:INFO:CALibration:PARAMeters?
// "Level,Phase,Time"
SCONfiguration:RFALignment:SETup:INFO:CALibration:AGE?
// 52
SCONfiguration:RFALignment:SETup:INFO:CALibration:TEMPerature:OFFSet?
// 0
SCONfiguration:RFALignment:SETup:INFO:WIRing:LO:SOURce?
// PRIM
SCONfiguration:RFALignment:SETup:INFO:WIRing:LO:CONStellation?
// DCH
SCONfiguration:RFALignment:SETup:INFO:WIRing:REF:SOURce?
// PRIM

SCONfiguration:RFALignment:SETup:INFO:CALibration:FREQuency:MODE?
// RANG
SCONfiguration:RFALignment:SETup:INFO:CALibration:FREQuency:RANGE:LOWer?
// 1000000000
SCONfiguration:RFALignment:SETup:INFO:CALibration:FREQuency:RANGE:UPPer?
// 6000000000
SCONfiguration:RFALignment:SETup:INFO:CALibration:FREQuency:STEP?
// 500000000
SCONfiguration:RFALignment:SETup:INFO:CALibration:LOCoupling?
// ACT

SCONfiguration:RFALignment:SETup:INFO:CALibration:POWer:MODE?
// RANG
SCONfiguration:RFALignment:SETup:INFO:CALibration:POWer:RANGE:LOWer?
// -10
SCONfiguration:RFALignment:SETup:INFO:CALibration:POWer:RANGE:UPPer?
// 0
SCONfiguration:RFALignment:SETup:INFO:CALibration:POWer:STEP?
// 10

SOURcel:RFALignment:CALibrated:FREQuency?
// 1000000000
SOURcel:RFALignment:CALibrated:POWer:PEP?
// -30
SOURcel:RFALignment:DATTenuation?
// 0
SOURcel:RFALignment:FOFFset
```

```
// 0
SOURCEl:RFAlIgnment:CORREction:IQDeLay?
// 0
SOURCEl:RFAlIgnment:CORREction:LEVEl?
// 0
SOURCEl:RFAlIgnment:CORREction:PHASe?
// 0
```

See also [Section 14.19.20, "RF ports alignment commands"](#), on page 1285.

:SCONfiguration:RFAlIgnment:SETUp:PREDeFined:CATalog?	998
:SCONfiguration:RFAlIgnment:SETUp:FILE:PREDeFined	998
:SCONfiguration:RFAlIgnment:SETUp:CATalog?	999
:SCONfiguration:RFAlIgnment:SETUp:FILE	999
:SCONfiguration:RFAlIgnment:SETUp:STATus?	999
:SCONfiguration:RFAlIgnment:ALIGn	1000
:SCONfiguration:RFAlIgnment:STATe	1000
:SCONfiguration:RFAlIgnment:SETUp:INFO:CALibration:DATE?	1000
:SCONfiguration:RFAlIgnment:SETUp:INFO:CALibration:TIME?	1001
:SCONfiguration:RFAlIgnment:SETUp:INFO:CALibration:AGE?	1001
:SCONfiguration:RFAlIgnment:SETUp:INFO:CALibration:TEMPerature:OFFSet?	1001
:SCONfiguration:RFAlIgnment:SETUp:INFO:CALibration:PARAmeters?	1001
:SCONfiguration:RFAlIgnment:SETUp:INFO:CALibration:FREQuency:MODE?	1002
:SCONfiguration:RFAlIgnment:SETUp:INFO:CALibration:POWEr:MODE?	1002
:SCONfiguration:RFAlIgnment:SETUp:INFO:CALibration:FREQuency:LIST:VALues?	1002
:SCONfiguration:RFAlIgnment:SETUp:INFO:CALibration:POWEr:LIST:VALues?	1002
:SCONfiguration:RFAlIgnment:SETUp:INFO:CALibration:FREQuency:RANGe:LOWer?	1003
:SCONfiguration:RFAlIgnment:SETUp:INFO:CALibration:FREQuency:RANGe:UPPer?	1003
:SCONfiguration:RFAlIgnment:SETUp:INFO:CALibration:POWEr:RANGe:LOWer?	1003
:SCONfiguration:RFAlIgnment:SETUp:INFO:CALibration:POWEr:RANGe:UPPer?	1003
:SCONfiguration:RFAlIgnment:SETUp:INFO:CALibration:FREQuency:STEP?	1003
:SCONfiguration:RFAlIgnment:SETUp:INFO:CALibration:POWEr:STEP?	1003
:SCONfiguration:RFAlIgnment:SETUp:INFO:CALibration:LOCoupling?	1004
:SCONfiguration:RFAlIgnment:SETUp:INFO:WIRing:LO:CONStellation?	1004
:SCONfiguration:RFAlIgnment:SETUp:INFO:WIRing:LO:SOURce?	1004
:SCONfiguration:RFAlIgnment:SETUp:INFO:WIRing:REF:SOURce?	1005

---

#### :SCONfiguration:RFAlIgnment:SETUp:PREDeFined:CATalog?

Queries the names of the existing predefined setup files.

Only files with extension `*.rfসা` are listed.

**Example:** See [Example "Loading and activating setup files"](#) on page 996.

**Usage:** Query only

**Manual operation:** See ["Setup"](#) on page 682

---

#### :SCONfiguration:RFAlIgnment:SETUp:FILE:PREDeFined <Filename>

Loads the selected predefined file.

**Setting parameters:**

<Filename> "<filename>"  
 File extension can be omitted.  
 Query the filenames of predefined setup files with the command `:SCONfiguration:RFALignment:SETup:PREDEFINED:CATalog?`.

**Example:** See [Example "Loading and activating setup files"](#) on page 996.

**Usage:** Setting only

**Manual operation:** See ["Setup"](#) on page 682

**:SCONfiguration:RFALignment:SETup:CATalog?**

Queries the names of the existing setup files in the default directory.

Per default, the instrument saves user-defined files in the `/var/user/` directory. Use the command `:MMEM:CDIRectory` to change the default directory to the currently used one.

Only files with extension `*.rfsa` are listed.

**Example:** See [Example "Loading and activating setup files"](#) on page 996.

**Usage:** Query only

**Manual operation:** See ["Setup"](#) on page 682

**:SCONfiguration:RFALignment:SETup:FILE <SetupFile>**

Loads the selected file from the default or the specified directory. Loaded are files with extension `*.rfsa`.

**Parameters:**

<SetupFile> "<filename>"  
 Filename or complete file path; file extension can be omitted.  
 Query the filenames of existing setup files with the command `:SCONfiguration:RFALignment:SETup:CATalog?`.

**Example:** See [Example "Loading and activating setup files"](#) on page 996.

**Manual operation:** See ["Setup"](#) on page 682

**:SCONfiguration:RFALignment:SETup:STATus?**

Queries information on the internal compensation status and the connected secondary instruments.

**Return values:**

<SetupStatus> NALign | ALIGNed | ERRor | WARNing | INACTive | NOSetup | INValid  
 NOSetup = Setup is not loaded

INValid = Loaded setup does not match the current setup  
 INACTive = Setup loaded but RF port alignment not enabled  
 NALign = Setup is loaded but aligned not triggered  
 ALIGNed | ERRor | WARNing = Setup is aligned, error,  
 warning  
 \*RST: n.a. (factory preset)

**Example:** See [Example "Loading and activating setup files"](#) on page 996.  
**Usage:** Query only  
**Manual operation:** See ["Status"](#) on page 683

#### :SCONfiguration:RFALignment:ALIGN

If a valid setup is loaded and RF ports alignment is enabled, sends the multi instrument trigger signal to all instruments to synchronize the basebands of the instruments.

**Example:** See [Example "Loading and activating setup files"](#) on page 996.  
**Usage:** Event  
**Manual operation:** See ["Align"](#) on page 683

#### :SCONfiguration:RFALignment:STATE <State>

If a valid setup file is selected, applies the specified correction data.

Load the setup file with the command `:SCONfiguration:RFALignment:SETup:FILE`.

##### Parameters:

<State> 1 | ON | 0 | OFF  
 \*RST: n.a. (factory preset: 0)

**Example:** See [Example "Loading and activating setup files"](#) on page 996.  
**Manual operation:** See ["State"](#) on page 681

#### :SCONfiguration:RFALignment:SETup:INFO:CALibration:DATE?

Queries the time the calibration described in the loaded setup file is performed.

##### Return values:

<Date> string

**Example:** See [Example "Retrieving details on the calibrated values"](#) on page 997.  
**Usage:** Query only  
**Manual operation:** See ["Calibration Date/Time"](#) on page 685



---

**:SCONfiguration:RFALignment:SETup:INFO:CALibration:TIME?**

The date and time the calibration described in the loaded setup file is performed.

**Return values:**

<Time> string

**Example:** See [Example "Retrieving details on the calibrated values"](#) on page 997.

**Usage:** Query only

**Manual operation:** See ["Calibration Date/Time"](#) on page 685

---

**:SCONfiguration:RFALignment:SETup:INFO:CALibration:AGE?**

Queries how many days are passed since the moment the calibration described in the loaded setup file is performed.

**Return values:**

<Days> integer  
Time since calibration in days

**Example:** See [Example "Retrieving details on the calibrated values"](#) on page 997.

**Usage:** Query only

**Manual operation:** See ["Time since Last Calibration"](#) on page 686

---

**:SCONfiguration:RFALignment:SETup:INFO:CALibration:TEMPerature:OFFSet?**

Queries the difference in temperature since the moment the calibration described in the loaded setup file is performed.

**Return values:**

<TempOffset> float  
Increment: 0.01

**Example:** See [Example "Retrieving details on the calibrated values"](#) on page 997.

**Usage:** Query only

**Manual operation:** See ["Temperature Offset to Last Calibration"](#) on page 686

---

**:SCONfiguration:RFALignment:SETup:INFO:CALibration:PARAmeters?**

Queries information on the major calibrated parameters.

**Return values:**

<CalibratedParam> string

**Example:** See [Example "Retrieving details on the calibrated values"](#) on page 997.

**Usage:** Query only

**Manual operation:** See ["Calibrated Parameters"](#) on page 685

**:SCONfiguration:RFALignment:SETup:INFO:CALibration:FREQuency:MODE?**  
**:SCONfiguration:RFALignment:SETup:INFO:CALibration:POWer:MODE?**

Queries the method used to be defined the calibrated frequency and PEP ranges.

**Return values:**

<Mode> RANGE | LIST

**RANGE**

Range, see:

[:SCONfiguration:RFALignment:SETup:INFO:](#)

[CALibration:FREQuency:RANGE:LOWer?](#) on page 1003

[:SCONfiguration:RFALignment:SETup:INFO:](#)

[CALibration:FREQuency:RANGE:UPPer?](#) on page 1003

[:SCONfiguration:RFALignment:SETup:INFO:](#)

[CALibration:FREQuency:STEP?](#) on page 1003

[:SCONfiguration:RFALignment:SETup:INFO:](#)

[CALibration:POWer:RANGE:LOWer?](#) on page 1003

[:SCONfiguration:RFALignment:SETup:INFO:](#)

[CALibration:POWer:RANGE:UPPer?](#) on page 1003

[:SCONfiguration:RFALignment:SETup:INFO:](#)

[CALibration:POWer:STEP?](#) on page 1003

**LIST**

List, see:

[:SCONfiguration:RFALignment:SETup:INFO:](#)

[CALibration:FREQuency:LIST:VALues?](#) on page 1002

[:SCONfiguration:RFALignment:SETup:INFO:](#)

[CALibration:POWer:LIST:VALues?](#) on page 1002

**Example:** See [Example "Retrieving details on the calibrated values"](#) on page 997.

**Usage:** Query only

**Manual operation:** See ["Mode"](#) on page 686

**:SCONfiguration:RFALignment:SETup:INFO:CALibration:FREQuency:LIST:**  
**VALues?**

**:SCONfiguration:RFALignment:SETup:INFO:CALibration:POWer:LIST:VALues?**

**Return values:**

<ListOfValues> string

**Example:**

```
SCONfiguration:RFALignment:SETup:INFO:CALibration:LOCoupling?
// NACTive
SCONfiguration:RFALignment:SETup:INFO:CALibration:POWER:MODE?
// LIST
SCONfiguration:RFALignment:SETup:INFO:CALibration:POWER:LIST:VALues?
// -21,-15,-10
```

**Usage:** Query only

**Manual operation:** See ["Frequency Values/PEP Values"](#) on page 687

**:SCONfiguration:RFALignment:SETup:INFO:CALibration:FREQuency:RANGe:LOWER?**

**:SCONfiguration:RFALignment:SETup:INFO:CALibration:FREQuency:RANGe:UPPer?**

**:SCONfiguration:RFALignment:SETup:INFO:CALibration:POWER:RANGe:LOWER?**

**:SCONfiguration:RFALignment:SETup:INFO:CALibration:POWER:RANGe:UPPer?**

Queries the min and max frequency and PEP values that define the calibrated range.

**Return values:**

<PEPmax> float  
Increment: 0.01

**Example:** See [Example "Retrieving details on the calibrated values"](#) on page 997.

**Usage:** Query only

**Manual operation:** See ["Frequency Range/PEP Range"](#) on page 686

**:SCONfiguration:RFALignment:SETup:INFO:CALibration:FREQuency:STEP?**

**:SCONfiguration:RFALignment:SETup:INFO:CALibration:POWER:STEP?**

Queries the frequency/PEP step size with that the calibration values are selected from the defined value range.

**Return values:**

<PEPstep> float  
Increment: 0.01

**Example:** See [Example "Retrieving details on the calibrated values"](#) on page 997.

**Usage:** Query only

**Manual operation:** See ["Frequency Step/PEP Step"](#) on page 687

---

**:SCONfiguration:RFALignment:SETup:INFO:CALibration:LOCoupling?**

Queries whether the instruments use a common local oscillator (LO) signal or not.

**Return values:**

<State>                   ACTive | NACTive

**ACTive**

All instruments are connected to the same LO reference frequency.

**NACTive**

Each instrument uses its own local oscillator.

\*RST:           n.a. (factory preset)

**Example:**                See [Example "Retrieving details on the calibrated values"](#) on page 997.

**Usage:**                   Query only

**Manual operation:**    See "[LO Coupling](#)" on page 687

---

**:SCONfiguration:RFALignment:SETup:INFO:WIRing:LO:CONStellation?**

Queries the connection method used to distribute the LO frequency signal.

**Return values:**

<Constellation>        DCHain | STAR

**DCHain**

Daisy chain

**STAR**

Star

**Example:**                See [Example "Retrieving details on the calibrated values"](#) on page 997.

**Usage:**                   Query only

**Manual operation:**    See "[LO Configuration > Wiring Constellation](#)" on page 691

---

**:SCONfiguration:RFALignment:SETup:INFO:WIRing:LO:SOURce?**

Queries if the current instrument uses its own or an external LO signal.

**Return values:**

<Source>                PRIMary | EXTernal

**PRIMary**

The instrument uses its LO signal and provides it to the other instruments.

**EXTernal**

The instrument uses an external LO signal, for example from other R&S SMW200A (the one with `SCONfiguration:RFALignment:SETup:INFO:WIRing:LO:SOURce PRIMary`).

- Example:** See [Example "Retrieving details on the calibrated values"](#) on page 997.
- Usage:** Query only
- Manual operation:** See ["LO Configuration > Signal Source"](#) on page 690

#### :SCONfiguration:RFALignment:SETup:INFO:WIRing:REF:SOURce?

Queries if the current instrument uses its own or an external reference signal.

**Return values:**

<Source> PRIMary | EXTernal

**PRIMary**

The instrument uses its reference signal and provides it to the other instruments.

**EXTernal**

The instrument uses an external reference frequency source, for example from other R&S SMW200A (the one with `SCONfiguration:RFALignment:SETup:INFO:WIRing:REF:SOURce PRIMary`) or from R&S®SMA100B.

- Example:** See [Example "Retrieving details on the calibrated values"](#) on page 997.
- Usage:** Query only
- Manual operation:** See ["Ref Configuration > Signal Source"](#) on page 690

## 14.19 SOURce subsystem

The SOURce subsystem contains the commands for configuring signals.

**Common suffixes**

The following common suffixes are used in remote commands:

Suffix	Value range	Description
ENTity<ch>	1 to 4	Entity in a multiple entity configuration
SOURce<hw>	[1] to 8	Baseband signals/paths <ul style="list-style-type: none"> <li>SOURce[1] = Path A/Baseband A (optional keyword and suffix)</li> <li>SOURce2 = Path B/Baseband B (mandatory keyword and suffix)</li> <li>LF output = SOURce:LFOutput (SOURce is optional keyword)</li> </ul>
OUTPut<ch>	[1] to 3	Available markers

You can address multiple entities configurations by using the SCPI commands starting with the keyword SOURce or the alias commands starting with the keyword ENTity.

See also [Section 14.3, "SCPI command aliases for advanced mode with multiple entities"](#), on page 896.

• <a href="#">Connector settings</a> .....	1006
• <a href="#">SOURce:AWGN subsystem</a> .....	1016
• <a href="#">SOURce:BBIN subsystem</a> .....	1026
• <a href="#">Analog modulation subsystems</a> .....	1036
• <a href="#">SOURce:BB subsystem</a> .....	1056
• <a href="#">SOURce:CORRection subsystem</a> .....	1185
• <a href="#">SOURce:FREQUency subsystem</a> .....	1197
• <a href="#">SOURce:FREQUency:CONVerter subsystem</a> .....	1206
• <a href="#">SOURce:INPut subsystem</a> .....	1208
• <a href="#">SOURce:IQ subsystem</a> .....	1209
• <a href="#">SOURce:IQ:OUTPut subsystem</a> .....	1212
• <a href="#">SOURce:LFOutput subsystem</a> .....	1227
• <a href="#">SOURce:LIST subsystem</a> .....	1240
• <a href="#">SOURce:NOISe subsystem</a> .....	1254
• <a href="#">SOURce:OCCupy subsystem</a> .....	1260
• <a href="#">SOURce:PGEN subsystem</a> .....	1262
• <a href="#">SOURce:PHASe subsystem</a> .....	1263
• <a href="#">SOURce:POWer subsystem</a> .....	1264
• <a href="#">SOURce:ROSCillator subsystem</a> .....	1280
• <a href="#">RF ports alignment commands</a> .....	1285
• <a href="#">SOURce:SWEep subsystem</a> .....	1287

### 14.19.1 Connector settings

This section summarizes the commands of the `OUTPut` and `INPut` subsystems, necessary to configure the connectors settings. Listed are the commands for configuring the output signals and the inputs for trigger, data, and control signals.

The `...:USER<ch>:...` commands determine the global trigger threshold and input impedance values, that affect all trigger and control signal inputs. The connector settings concern to all digital modulations, the generation of waveforms or multi carrier signals, and all digital standards.

See [Section 14.19.9, "SOURce:INPut subsystem"](#), on page 1208 for a description of the commands for configuring the inputs for external modulation signals.

See also [Section 12.2, "Configuring local and global connectors"](#), on page 742.

**Example: Configuring global connectors**

```

// *****
// Check the signal routing for a global connector, for example connector User 1.
// *****
SOURCE1:INPut:USER1:DIRection?
// Response: "UNUS"
// User 1 connector is not in use.
SOURCE1:INPut:USER1:SIGnal?
// Response: "NONE"
OUTPut1:USER1:SIGnal?
// Response: "NONE"
// User 1 connector expects no input signal and no output signal.

// *****
// Set signal direction and signal type.
// *****
SOURCE1:INPut:USER1:DIRection INP
SOURCE1:INPut:USER1:SIGnal TRIG1
SOURCE1:INPut:USER2:DIRection OUTP
SOURCE1:INPut:USER2:SIGnal MARKA2
SOURCE1:INPut:USER3:DIRection INP
SOURCE1:INPut:USER3:SIGnal NSEGM1

SOURCE1:INPut:USER4:DIRection INP
SOURCE1:INPut:USER4:SIGnal IPULSA

SOURCE1:INPut:USER5:DIRection INP
SOURCE1:INPut:USER5:SIGnal TRIG2

// *****
// Set input signal characteristics.
// *****
SOURCE1:INPut:USER:TRIGger:LEVel 1.5
SOURCE1:INPut:USER:PULM:LEVel 2

// Sets a common threshold of 1.5 V for USER 1 to User 3 connectors. This
// threshold applies to all input signals, in this example, TRIG1 and NSEGM1.
// Sets a common threshold of 2 V for USER 4 to User 6 connectors. This
// threshold applies to all input signals, in this example, IPULSA and TRIG2.

SOURCE1:INPut:USER:IMPedance G1K
// Sets the impedance of 1 kOhm/GND for the trigger or clock input signals.
SOURCE1:INPut:CLOCK:SLOPe POS
// Sets a positive polarity of the active slope for clock input signals.
SOURCE1:INPut:TRIGger:SLOPe POS
// Sets a positive polarity of the active slope for trigger input signals.

// *****
// Set signal direction and signal type.
// *****
SOURCE1:INPut:USER1:DIRection INP
SOURCE1:INPut:USER1:SIGnal TRIG1
// The input signal at User 1 connector is a global trigger.

```

```

SOURce1:INPut:USER2:DIRection OUTP
OUTPut1:USER2:SIGNal?
// Response: "MARKA1"
// The output signal at User 2 connector is the baseband marker 1.

// *****
// Set input signal characteristics.
// *****
SOURce1:INPut:USER:TRIGger:LEVel 1.5
// Sets a common threshold of 1.5 V for User 1 to User 2 connectors. This
// threshold applies to all input signals, in this example, TRIG1.
SOURce1:INPut:USER:TRIGger:IMPedance G1K
// Sets the impedance of 1 kOhm/GND for the trigger or clock input signals.
SOURce1:INPut:CLOCK:SLOPe POS
// Sets a positive polarity of the active slope for clock input signals.
SOURce1:INPut:TRIGger:SLOPe POS
// Sets a positive polarity of the active slope for trigger input signals.

```

**Commands:**

<b>[:SOURce&lt;hw&gt;]:INPut:TM&lt;ch&gt;:DIRection</b> .....	1008
<b>:OUTPut&lt;hw&gt;:TM&lt;ch&gt;:DIRection</b> .....	1008
<b>[:SOURce]:INPut:USER&lt;ch&gt;:DIRection</b> .....	1009
<b>:OUTPut:USER&lt;ch&gt;:DIRection</b> .....	1009
<b>[:SOURce&lt;hw&gt;]:INPut:TM&lt;ch&gt;:SIGNal</b> .....	1009
<b>:OUTPut&lt;hw&gt;:TM&lt;ch&gt;:SIGNal</b> .....	1010
<b>[:SOURce]:INPut:USER&lt;ch&gt;:SIGNal</b> .....	1011
<b>:OUTPut:USER&lt;ch&gt;:SIGNal</b> .....	1012
<b>:OUTPut:USER&lt;ch&gt;:TRIGger[:IMMediate]</b> .....	1013
<b>[:SOURce]:INPut:USER:CLOCK:LEVel</b> .....	1013
<b>[:SOURce]:INPut:USER:TRIGger:LEVel</b> .....	1013
<b>[:SOURce]:INPut:USER:PULM:LEVel</b> .....	1014
<b>[:SOURce]:INPut:USER:CLOCK:IMPedance</b> .....	1014
<b>[:SOURce]:INPut:USER:TRIGger:IMPedance</b> .....	1014
<b>[:SOURce]:INPut:USER:CLOCK:SLOPe</b> .....	1014
<b>[:SOURce]:INPut:USER:TRIGger:SLOPe</b> .....	1014
<b>[:SOURce&lt;hw&gt;]:INPut:TM:CLOCK:LEVel</b> .....	1015
<b>[:SOURce&lt;hw&gt;]:INPut:TM:TRIGger:LEVel</b> .....	1015
<b>[:SOURce&lt;hw&gt;]:INPut:TM:CLOCK:IMPedance</b> .....	1015
<b>[:SOURce&lt;hw&gt;]:INPut:TM:TRIGger:IMPedance</b> .....	1015
<b>[:SOURce&lt;hw&gt;]:INPut:TM:CLOCK:SLOPe</b> .....	1015
<b>[:SOURce&lt;hw&gt;]:INPut:TM:TRIGger:SLOPe</b> .....	1016

---

**[:SOURce<hw>]:INPut:TM<ch>:DIRection <Direction>**

**:OUTPut<hw>:TM<ch>:DIRection <Direction>**

Determines whether the connector is used as an input or an output.



**Suffix:**

OUTPut<hw> | 1 | 2  
 SOURce<hw> Determines the baseband the connectors belong to, where:  
 OUTPut1 | SOURce1 = Baseband A/C and  
 OUTPut2 | SOURce2 = Baseband B/D

TM<ch> 1|2|3  
 Determines the local connector, where:  
 Option:R&S SMW-B10  
 OUTPut1:TM1 | 2 | 3 and SOURce1:INPut:TM1 | 2 | 3 define  
 TMC1/2/3 of Baseband A/C and  
 OUTPut2:TM1 | 2 | 3 and SOURce2:INPut:TM1 | 2 | 3 define  
 TMC4/5/6 of Baseband B/D  
 Option:R&S SMW-B9  
 OUTPut1:TM1 | 2 and SOURce1:INPut:TM2 = TMC1/2 of  
 Baseband A/C and  
 OUTPut2:TM1 | 2 and SOURce2:INPut:TM2 = TMC3/4 of  
 Baseband B/D

**Parameters:**

<Direction> INPut | OUTPut  
 \*RST: OUTPut

**Manual operation:** See "[Direction](#)" on page 758

**[ :SOURce]:INPut:USER<ch>:DIRection <Direction>**  
**:OUTPut:USER<ch>:DIRection <Direction>**

Sets the direction of the signal at the connector that can be an input or an output.

**Suffix:**

USER<ch> 1 to 6  
 "User" connector number

**Parameters:**

<Direction> INPut | OUTPut | UNUSed  
**INPut|OUTPut**  
 Input signal or output signal  
**UNUSed**  
 No signals present at the connector.

**Example:** See [Example "Configuring global connectors"](#) on page 1007.

**Manual operation:** See "[Direction](#)" on page 754

**[ :SOURce<hw>]:INPut:TM<ch>:SIGNal <Signal>**

Determines the control signal that is input at the selected connector.

To define the connector direction, use the command [\[ :SOURce<hw> \] :INPut :  
 TM<ch>:DIRection](#).

**Suffix:**

SOURce&lt;hw&gt;

1 | 2

Determines the baseband the connectors belong to, where:

SOURce1 = Baseband A/C and

SOURce2 = Baseband B/D

TM&lt;ch&gt;

1|2|3

Determines the local connector, where:

Option:R&amp;S SMW-B10

SOURce1:INPut:TM1|2|3 = TMC1/2/3 of Baseband A/C and

SOURce2:INPut:TM1|2|3 = TMC4/5/6 of Baseband B/D

Option:R&amp;S SMW-B9

SOURce1:INPut:TM1|2 = TMC1/2 of Baseband A/C and

SOURce2:INPut:TM1|2 = TMC3/4 of Baseband B/D

**Parameters:**

&lt;Signal&gt;

TRIGger | CLOCk | FEEDback | DATA

CLOCk is available only for TM1

DATA is available only for TM2

(default if custom digital modulation with external serial data is used)

FEEDback is available only for TM3 (R&amp;S SMW-B10)/TM2

(R&amp;S SMW-B9)

**Options:**

TM3, TRIGger|CLOCK requires R&amp;S SMW-B10

**Manual operation:**See "[Signal](#)" on page 758**:OUTPut<hw>:TM<ch>:SIGNal** <Signal>

Determines the control signal that is output at the selected connector.

To define the connector direction, use the command `:OUTPut<hw>:TM<ch>:DIRection`.**Suffix:**

OUTPut&lt;hw&gt;

1 | 2

Determines the baseband the connectors belong to, where:

OUTPut1 = Baseband A/C or Baseband 1/3

OUTPut2 = Baseband B/D or Baseband 2/4

TM<ch> 1|2|3  
 Determines the local connector, where:  
 Option:R&S SMW-B10  
 OUTPut1:TM1|2|3 = TMC1/2/3 of Baseband A/C or 1/3 and  
 OUTPut2:TM1|2|3 = TMC4/5/6 of Baseband B/D or 2/4  
 Option:R&S SMW-B9  
 OUTPut1:TM1|2 = TMC1/2 of Baseband A/C and  
 OUTPut2:TM1 = TMC3 of Baseband B/D

**Parameters:**

<Signal> MARKA1 | MARKA2 | MARKA3 | SCLA | LATT A | BGATA |  
 HOPA | CWMODA | TRIGA | MARKB1 | MARKB2 | MARKB3 |  
 SCLB | LATTB | BGATB | HOPB | CWMODB | TRIGB |  
 MARKC1 | MARKC2 | MARKC3 | SCLC | LATT C | BGATC |  
 HOPC | CWMODC | TRIGC | MARKD1 | MARKD2 | MARKD3 |  
 SCLD | LATTD | BGATD | HOPD | CWMODD | TRIGD  
 MARKA1 | MARKC1 | MARKA2 | MARKC2 | (MARKA3 | MARKC3) =  
 Baseband A/C Marker 1/2/(3)  
 SCLA | SCLB | SCLC | SCLD = Symbol Clock A/B/C/D  
 Option:R&S SMW-B10  
 LATT A | LATTB | LATT C | LATTD = Lev Att A/B/C/D  
 BGATA | BGATB | BGATC | BGATD = Burst Gate A/B/C/D  
 HOPA | HOPB | HOPC | HOPD = HOP A/B/C/D  
 CWMODA | CWMODB | CWMODC | CWMODD = CW/Mod A/B/C/D  
 TRIGA | TRIGB | TRIGC | TRIGD = Triggered A  
 The character A/B/C/D in the parameter value indicates the  
 baseband the signal is related to.  
 \*RST: depends on TM suffix

**Example:**  
 :SOURce1:INPut:TM2:DIRection OUTPut  
 :OUTPut1:TM2:DIRection?  
 // OUTPut  
 :OUTPut1:TM2:SIGNal MARKA2

**Options:** TMC4/5/6, LATT A|LATTB|LATT C|LATTD| BGATA|BGATB|  
 BGATC|BGATD| HOPA|HOPB|HOPC|HOPD| CWMODA|  
 CWMODB|CWMODC|CWMODD| TRIGA|TRIGB|TRIGC|TRIGD  
 require R&S SMW-B10

**Manual operation:** See "[Signal](#)" on page 758

---

**[ :SOURce ] : INPut : USER <ch> : SIGNal <Signal>**

Determines the control signal that is input at the selected connector.

To define the connector direction, use the command `[ :SOURce ] : INPut : USER <ch> : DIRection`.

<b>Suffix:</b>	
USER<ch>	1 to 6
<b>Parameters:</b>	
<Signal>	TRIG1   TRIG2   CLOCK1   CLOCK2   NSEGM1   NSEGM2   NONE   FEEDback   IPULSA   IPULSB   ERRTA   ERRTB   BERDATIN   BERCLKIN   BERDATENIN   BERRESTIN   SYNCIN  TRIG1   TRIG2 = Global Trigger 1/2 CLOCK1   CLOCK2 = Global Clock 1/2 NSEGM1   NSEGM2 = Global Next Segment 1/2 IPULSA   IPULSB = Pulse In A/B, available for USER4   5   6 FEEDback = Baseband Feedback, available for USER6 SYNCIN = Baseband Sync In BERDATIN   BERCLKIN   BERDATENIN   BERRESTIN = BER Data, Clock, Data Enable and Restart ERRTA   ERRTB = External restart trigger signals for REG
<b>Example:</b>	See <a href="#">Example "Configuring global connectors"</a> on page 1007.
<b>Options:</b>	SYNCIN requires R&S SMW-B9 BERDATIN BERCLKIN BERDATENIN BERRESTIN require R&S SMW-K80 ERRTA ERRTB require R&S SMW-K78
<b>Manual operation:</b>	See <a href="#">"Signal"</a> on page 754

---

**:OUTPut:USER<ch>:SIGNal** <Signal>

Sets the control signal that is output at the selected connector.

To define the connector direction, use the command [:OUTPut:USER<ch>:DIRection](#).

<b>Suffix:</b>	
USER<ch>	1 to 6
<b>Parameters:</b>	
<Signal>	MARKA1   MARKA2   MARKA3   MARKB1   MARKB2   MARKB3   MARKC1   MARKC2   MARKC3   MARKD1   MARKD2   MARKD3   SVALA   SVALB   OPULSA   OPULSB   SYNCA   VIDEOA   VIDEOB   SYNCB   NONE   RTRIGA   RTRIGB   SVALANegated   SVALBNegated   LOW   HIGH   MTRigger   SYNCOUT   BERRESTOUT   BERDATENOUT   BERCLKOUT   BERDATOUT  MARK<A B C D><1 2 3> = Baseband <BB> Marker 1/2/3 (available marker signals depend on the system configuration, see <a href="#">Table 12-1</a> ) SVALA   SVALB = Signal Valid A/B, available for USER4   5   6 SVALANegated   SVALBNegated = Signal Valid A/B (negative), available for USER4   5   6

OPULSA | OPULSB = Pulse Out A/B, available for USER4 | 5 | 6  
 SYNCA | SYNCB = Pulse Sync A/B, available for USER4 | 5 | 6  
 VIDEOA | VIDEOB = Pulse Video A/B, available for USER4 | 5 | 6  
 MTRigger = Manual Trigger, available for USER6  
 RTRIGA | RTRIGB = REG trigger A/B, available for USER4 | 5  
 BERRESTOUT | BERDATENOUT | BERCLKOUT | BERDATOUT =  
 BERT TestGen Data, Clock, Data Enable and Restart  
 SYNCOUT = Baseband Sync Out  
 LOW | HIGH = Always 0/1  
 NONE = none  
 \*RST: MARKA1

**Example:** See [Example "Configuring global connectors"](#) on page 1007.

**Options:** SYNCOUT requires R&S SMW-B9  
 BERRESTOUT|BERDATENOUT|BERCLKOUT|BERDATOUT  
 require R&S SMW-K80  
 RTRIGA|RTRIGB require R&S SMW-K78

**Manual operation:** See ["Signal"](#) on page 754

#### **:OUTPut:USER<ch>:TRIGger[:IMMediate]**

Generates a short pulse signal and outputs it at the USER connector.

This signal can serve as a common external trigger signal for triggering of several R&S SMW200A, see [Example "Triggering several R&S SMW200A instruments simultaneously"](#) on page 678.

**Suffix:**  
 USER<ch> 1 to 6

**Example:** See [Example "Configuring global connectors"](#) on page 1007.

**Usage:** Event

**Manual operation:** See ["Execute Trigger"](#) on page 756

**[:SOURce]:INPut:USER:CLOCK:LEVel <Level>**  
**[:SOURce]:INPut:USER:TRIGger:LEVel <Level>**

Sets the threshold for any input signal at the "USER 1" to "USER 3" connectors.

**Parameters:**  
 <Level> float  
 Range: 0.1 to 2  
 Increment: 0.1  
 \*RST: 1

**Example:** See [Example "Configuring global connectors"](#) on page 1007.

**Manual operation:** See ["Threshold USER1-3 Input"](#) on page 756

---

**[[:SOURce]:INPut:USER:PULM:LEVEl <Level>**

Sets the threshold for any input signal at the USER4 to USER6 connectors.

**Parameters:**

<Level> float  
 Range: 0.1 to 2  
 Increment: 0.1  
 \*RST: 1  
 Default unit: V

**Example:** See [Example "Configuring global connectors"](#) on page 1007.

**Manual operation:** See ["Threshold USER4-6 Input/Threshold Pulse Input"](#) on page 559

---

**[[:SOURce]:INPut:USER:CLOCK:IMPedance <Impedance>**

**[[:SOURce]:INPut:USER:TRIGger:IMPedance <Impedance>**

Selects the input impedance for the external trigger inputs.

**Parameters:**

<Impedance> G50 | G1K  
**G50**  
 50 Ω per ground  
**G1K**  
 1 kΩ per ground  
 \*RST: G1K

**Example:** See [Example "Configuring global connectors"](#) on page 1007.

**Manual operation:** See ["Impedance Clock/Trigger Input"](#) on page 757

---

**[[:SOURce]:INPut:USER:CLOCK:SLOPe <Slope>**

Sets the polarity of the active slope of an externally applied clock signal.

**Parameters:**

<Slope> NEGative | POSitive  
 \*RST: POSitive

**Example:** See [Example "Configuring global connectors"](#) on page 1007.

**Manual operation:** See ["Clock Input Slope"](#) on page 757

---

**[[:SOURce]:INPut:USER:TRIGger:SLOPe <Slope>**

Sets the polarity of the active slope of an external trigger signal.

**Parameters:**

<Slope> NEGative | POSitive  
 \*RST: POSitive

**Example:** See [Example "Configuring global connectors"](#) on page 1007.

**Manual operation:** See ["Trigger Input Slope"](#) on page 757

**[[:SOURce<hw>]:INPut:TM:CLOCK:LEVel <Level>**

**[[:SOURce<hw>]:INPut:TM:TRIGger:LEVel <Level>**

Sets the high/low threshold in volts for the trigger and clock signal inputs of the baseband section.

**Suffix:**

SOURce<hw> 1 | 2

Determines the baseband the connectors belong to, where:

SOURce1 = Baseband A/C and

SOURce2 = Baseband B/D

**Parameters:**

<Level> float

Range: 0.3 to 2

Increment: 0.1

\*RST: 1

**Manual operation:** See ["Threshold Clock/Trigger Input"](#) on page 759

**[[:SOURce<hw>]:INPut:TM:CLOCK:IMPedance <Impedance>**

**[[:SOURce<hw>]:INPut:TM:TRIGger:IMPedance <Impedance>**

Selects the input impedance for the external trigger/clock inputs.

**Suffix:**

SOURce<hw> 1 | 2

Determines the baseband the connectors belong to, where:

SOURce1 = Baseband A/C and

SOURce2 = Baseband B/D

**Parameters:**

<Impedance> G50 | G1K

**G50**

50 Ω per ground

**G1K**

1 kΩ per ground

**G10K**

For backward compatibility with other Rohde & Schwarz signal generators. The R&S SMW200A maps this value to G1K.

\*RST: G1K

**Manual operation:** See ["Impedance Clock/Trigger Input"](#) on page 760

**[[:SOURce<hw>]:INPut:TM:CLOCK:SLOPe <Slope>**

Sets the polarity of the active slope of an externally applied clock signal.

**Suffix:**

SOURce&lt;hw&gt; 1 | 2

Determines the baseband the connectors belong to, where:

SOURce1 = Baseband A/C and

SOURce2 = Baseband B/D

**Parameters:**

&lt;Slope&gt; NEGative | POSitive

\*RST: POSitive

**Manual operation:** See "[Clock Input Slope](#)" on page 274**[ :SOURce<hw> ] :INPut:TM:TRIGger:SLOPe <Slope>**

Sets the polarity of the active slope of an externally applied trigger signal.

**Suffix:**

SOURce&lt;hw&gt; 1 | 2

Determines the baseband the connectors belong to, where:

SOURce1 = Baseband A/C and

SOURce2 = Baseband B/D

**Parameters:**

&lt;Slope&gt; NEGative | POSitive

\*RST: POSitive

**Manual operation:** See "[Trigger Input Slope](#)" on page 760

## 14.19.2 SOURce:AWGN subsystem

The SOURce:AWGN subsystem contains the commands for setting the noise generator.

**Suffixes in the keywords ENTity<ch> and SOURce<hw>**

You can address multiple entity configurations by using the SCPI commands starting with the keyword SOURce or the alias commands starting with the keyword ENTity.

**Table 14-1: Value ranges of the suffixes ENTity<ch> and SOURce<hw> in advanced configuration with multiple entities**

SCPI syntax	ENTity<ch>	SOURce<hw>
SOURce<hw>:AWGN:...	-	1 to 8
ENTity<ch>:SOURce<hw>:AWGN:...	1 to 8	1 to 4

The meaning of the numeric suffix to SOURce depends on:

- The presence of the keyword ENTity
- The selected :SCONfiguration:MODE
- The enabled MIMO configuration (:SCONfiguration:FADing)
- The state of the [ :SOURce<hw> ] :AWGN:CMODE [ :STATe ]





See the example in [Section 14.3, "SCPI command aliases for advanced mode with multiple entities"](#), on page 896.

### Required options

See [Section 6.2.1, "Required options"](#), on page 424.

### Programming examples

#### Example: To enable the AWGN generator and the streams

The following example shows the difference between working with coupled and uncoupled streams.

```
:SCONfiguration:MODE ADVanced
:SCONfiguration:FADing MIMO4X4
// Enable coupled mode for the AWGN generator and all four streams.
:SOURce1:AWGN:CMODE:STATe ON
:SOURce1:AWGN:STATe ON
// Enable uncoupled mode. Configure the streams individually.
:SOURce1:AWGN:CMODE:STATe OFF
:SOURce1:AWGN:STATe?
// Response: 1
:SOURce2:AWGN:STATe?
// Response: 0
:SOURce3:AWGN:STATe?
// Response: 0
:SOURce4:AWGN:STATe?
// Response: 0
// Stream B, stream C and stream D are disabled.
:SOURce4:AWGN:STATe ON
```

#### Example: To generate a pure noise signal

The following example generates a pure noise signal with a specified bandwidth and noise level.

```
:SCONfiguration:MODE STANdard
:SOURce1:AWGN:MODE ONLY
:SOURce1:AWGN:BWIDth 3840000
:SOURce1:AWGN:BWIDth:RATio 2
:SOURce1:AWGN:STATe ON
:SOURce1:AWGN:BWIDth:NOISe?
// Response: 7680000
:SOURce1:AWGN:FREQuency:CENTer:OFFSet 1000000
// Shifts the noise signal by 1 MHz relative to the carrier frequency.
:SOURce1:AWGN:DISP:MODE RFA
:SOURce1:AWGN:POWer:NOISe -80
:SOURce1:POWer:LEVel:IMMediate:AMPlitude?
// Response: -80
```

```
:SOURce1:AWGN:POWer:NOISe:TOTal?
// Response: -80
```

### Example: To generate a CW interferer signal

The following example generates a CW interferer signal with a specified target frequency and level.

```
:SCONfiguration:MODE ADVanced
:SCONfiguration:FADing MIMO2X2
:SOURce1:AWGN:CMODE:STATe OFF

:SOURce2:AWGN:MODE CW
:SOURce2:AWGN:FREQuency:TARGet 20000000
:SOURce2:AWGN:STATe ON
:SOURce2:AWGN:FREQuency:RESult?

:SOURce2:AWGN:POWer:RMODE CARRIER
:SOURce2:AWGN:CNRatio 10
:SOURce2:AWGN:POWer:CARRIER -80
// the Level display indicates the PEP of the carrier
:SOURce2:POWer:LEVel:IMMediate:AMPlitude?
Response: -80
// Query the power of the interfering signal
:SOURce2:AWGN:POWer:NOISe?
// Response: -90
:SOURce2:AWGN:POWer:SUM?
// Response: -79.5860731484178
:SOURce2:AWGN:POWer:SUM:PEP?
// Response: -80
```

### Example: To generate an additive noise signal

The following example shows how to adjust the AWGN settings to generate a signal with the following characteristics:

- The carrier signal is an uplink EUTRA/LTE signal with:
  - "Channel Bandwidth" = "1.4 GHz" corresponds to "Occupied Bandwidth" = "1.080 MHz"
  - "RF Frequency" = "1.95 GHz"
  - "RF Level" = "-76 dBm"
- Required is an SNR of 12.7 dB.

```
SCONfiguration:MODE STANdard

:SOURce1:FREQuency:CW 1950000000
:SOURce1:POWer:LEVel:IMMediate:AMPlitude -76

:SOURce1:AWGN:MODE ADD
// set the system bandwidht to the occupied bandwidth
:SOURce1:AWGN:BWIDth 1080000
:SOURce1:AWGN:BWIDth:RATio 1.5
```

```

:SOURce1:AWGN:STATe ON
:SOURce1:AWGN:BWIDth:NOISe?
// Response: 1620000

:SOURce1:AWGN:DISP:MODE RFA
:SOURce1:AWGN:POWer:MODE CN
:SOURce1:AWGN:POWer:RMODE CARRier
:SOURce1:AWGN:BRATe?
// Response: 100000
:SOURce1:AWGN:CNRatio 12.7
:SOURce1:AWGN:ENRatio?
// Response: 23.0342375548695
:SOURce1:AWGN:POWer:CARRier?
// Response: -76
// the Level display indicates the PEP of the carrier

// Query the resulting noise power, in the system and total bandwidht
:SOURce1:AWGN:POWer:NOISe?
// Response: -88.7
:SOURce1:AWGN:POWer:NOISe:TOTal?
// Response: -88.7
// Query the carrier+noise power and PEP
:SOURce1:AWGN:POWer:SUM?
// Response: -75.7728170942726
:SOURce1:AWGN:POWer:SUM:PEP?
// Response: -76

```

### 14.19.2.1 General commands

<a href="#">[:SOURce&lt;hw&gt;]:AWGN:CMODEf:STATe]</a> .....	1020
<a href="#">[:SOURce&lt;hw&gt;]:AWGN:STATe</a> .....	1020
<a href="#">[:SOURce&lt;hw&gt;]:AWGN:MODE</a> .....	1020
<a href="#">[:SOURce&lt;hw&gt;]:AWGN:BWIDth</a> .....	1020
<a href="#">[:SOURce&lt;hw&gt;]:AWGN:BWIDth:RATio</a> .....	1021
<a href="#">[:SOURce&lt;hw&gt;]:AWGN:BWIDth:NOISe?</a> .....	1021
<a href="#">[:SOURce&lt;hw&gt;]:AWGN:DISP:MODE</a> .....	1021
<a href="#">[:SOURce&lt;hw&gt;]:AWGN:POWer:MODE</a> .....	1022
<a href="#">[:SOURce&lt;hw&gt;]:AWGN:POWer:RMODE</a> .....	1022
<a href="#">[:SOURce&lt;hw&gt;]:AWGN:BRATe</a> .....	1022
<a href="#">[:SOURce&lt;hw&gt;]:AWGN:CNRatio</a> .....	1022
<a href="#">[:SOURce&lt;hw&gt;]:AWGN:ENRatio</a> .....	1023
<a href="#">[:SOURce&lt;hw&gt;]:AWGN:POWer:CARRier</a> .....	1023
<a href="#">[:SOURce&lt;hw&gt;]:AWGN:POWer:NOISe</a> .....	1023
<a href="#">[:SOURce&lt;hw&gt;]:AWGN:POWer:NOISe:TOTal?</a> .....	1024
<a href="#">[:SOURce&lt;hw&gt;]:AWGN:POWer:SUM?</a> .....	1024
<a href="#">[:SOURce&lt;hw&gt;]:AWGN:POWer:SUM:PEP?</a> .....	1024
<a href="#">[:SOURce&lt;hw&gt;]:AWGN:FREQuency:CENTer:OFFSet</a> .....	1025
<a href="#">[:SOURce&lt;hw&gt;]:AWGN:FREQuency:TARGet</a> .....	1025
<a href="#">[:SOURce&lt;hw&gt;]:AWGN:FREQuency:RESult?</a> .....	1025

---

**[[:SOURce<hw>]:AWGN:CMODE[:STATe] <State>**

Couples the configuration of all streams.

**Parameters:**

<State> 1 | ON | 0 | OFF  
\*RST: 1

**Example:** See [Example "To enable the AWGN generator and the streams"](#) on page 1017

**Manual operation:** See ["Coupled Mode"](#) on page 433

---

**[[:SOURce<hw>]:AWGN:STATe <State>**

Activates or deactivates the AWGN generator or the corresponding stream.

See also ["Suffixes in the keywords ENTity<ch> and SOURce<hw>"](#) on page 1016.

**Parameters:**

<State> 1 | ON | 0 | OFF  
\*RST: 0

**Example:** See [Example "To enable the AWGN generator and the streams"](#) on page 1017.s

**Manual operation:** See ["State"](#) on page 432

---

**[[:SOURce<hw>]:AWGN:MODE <Mode>**

Determines how the interfering signal is generated.

**Parameters:**

<Mode> ONLY | ADD | CW

**ADD**

The AWGN noise signal is added to the baseband signal.

**ONLY**

The pure AWGN noise signal is modulated to the carrier. The connection to the baseband is interrupted

**CW**

The sine interfering signal is added to the baseband signal.

\*RST: ADD

**Example:** See [Example "To generate an additive noise signal"](#) on page 1018

**Manual operation:** See ["Mode"](#) on page 433

---

**[[:SOURce<hw>]:AWGN:BWIDth <BWidth>**

Sets the system bandwidth.

**Parameters:**

<BWidth> float  
 Range: 1000 to 80E6  
 Increment: 100  
 \*RST: 3.84E6

**Example:** See [Example "To generate an additive noise signal"](#) on page 1018.

**Manual operation:** See ["System Bandwidth"](#) on page 433

**[:SOURce<hw>]:AWGN:BWIDth:RATio <Ratio>**

Sets the ratio of minimum real noise bandwidth to system bandwidth, see also ["Signal and noise parameters"](#) on page 426.

**Parameters:**

<Ratio> float  
 Range: 1 to Max  
 Increment: 0.1  
 \*RST: 1

**Example:** see [Example "To generate an additive noise signal"](#) on page 1018.

**Manual operation:** See ["Minimum Noise/System Bandwidth Ratio"](#) on page 434

**[:SOURce<hw>]:AWGN:BWIDth:NOISe?**

Queries the real noise bandwidth.

**Return values:**

<Noise> float  
 Range: 0 to 200E6  
 Increment: 100  
 \*RST: 0

**Example:** See [Example "To generate an additive noise signal"](#) on page 1018.

**Usage:** Query only

**Manual operation:** See ["Noise Bandwidth"](#) on page 440

**[:SOURce<hw>]:AWGN:DISP:MODE <Mode>**

Sets the output to that the AWGN settings are related.

**Parameters:**

<Mode> RFA | RFB | IQOUT1 | IQOUT2 | BBMM1 | BBMM2 | FADER1 |  
 FADER2 | FADER3 | FADER4  
 \*RST: RF

**Example:** See [Example "To generate an additive noise signal"](#) on page 1018.

**Manual operation:** See ["Show Powers For Output"](#) on page 435

**[[:SOURce<hw>]:AWGN:POWer:MODE <Mode>**

Selects the mode for setting the noise level.

**Parameters:**

<Mode> CN | SN | EN  
\*RST: SN

**Example:** see [Example "To generate an additive noise signal"](#) on page 1018

**Manual operation:** See ["Set Noise Power Via"](#) on page 436

**[[:SOURce<hw>]:AWGN:POWer:RMODe <RMode>**

Determines whether the carrier or the noise level is kept constant when the C/N value or Eb/N0 value is changed.

**Parameters:**

<RMode> CARRier | NOISe  
\*RST: CARRier

**Example:** See [Example "To generate an additive noise signal"](#) on page 1018

**Manual operation:** See ["Reference Mode"](#) on page 436

**[[:SOURce<hw>]:AWGN:BRATe <BRate>**

Sets the bit rate used for calculation of bit energy to noise power ratio.

Valid units are bps, kbps and mabps as well as b/s, kb/s and mab/s.

**Parameters:**

<BRate> float  
Range: 400 to depends on the installed options  
Increment: 0.001  
\*RST: 100000

**Example:** see [Example "To generate an additive noise signal"](#) on page 1018

**Manual operation:** See ["Bit Rate"](#) on page 436

**[[:SOURce<hw>]:AWGN:CNRatio <CnRatio>**

Sets the carrier/interferer ratio.

**Parameters:**

<CnRatio> float  
 Range: -50 to 45  
 Increment: 0.01  
 \*RST: 0

**Example:** See [Example "To generate an additive noise signal"](#) on page 1018

**Manual operation:** See ["Carrier/Noise Ratio, Signal/Noise Ratio"](#) on page 437

**[[:SOURce<hw>]:AWGN:ENRatio <EnRatio>**

Sets the ratio of bit energy to noise power density.

**Parameters:**

<EnRatio> float  
 Range: -50 to depends on the installed options  
 Increment: 0.01  
 \*RST: 15.84  
 Default unit: dB

**Example:** See [Example "To generate an additive noise signal"](#) on page 1018

**Manual operation:** See ["E<sub>b</sub>/N<sub>0</sub>"](#) on page 437

**[[:SOURce<hw>]:AWGN:POWer:CARRier <Carrier>**

Sets the carrier power.

**Parameters:**

<Carrier> float  
 Increment: 0.01  
 \*RST: 0

**Example:** see [Example "To generate an additive noise signal"](#) on page 1018

**Manual operation:** See ["Carrier Power, Signal Power"](#) on page 437

**[[:SOURce<hw>]:AWGN:POWer:NOISe <Noise>**

Sets the power of the noise signal in the system respectively total bandwidth.

**Parameters:**

<Noise> float  
 Increment: 0.01

**Example:** see [Example "To generate an additive noise signal"](#) on page 1018

**Manual operation:** See ["Noise Power \(System Bandwidth\), Interferer Power"](#) on page 438

---

**[[:SOURce<hw>]:AWGN:POWer:NOISe:TOTal?**

Queries the noise level in the total bandwidth.

**Return values:**

<Total> float  
 Range: -145 to 20  
 Increment: 0.01  
 \*RST: -30

**Example:** see [Example "To generate an additive noise signal"](#) on page 1018

**Usage:** Query only

**Manual operation:** See ["Noise Power \(Total Bandwidth\)"](#) on page 439

---

**[[:SOURce<hw>]:AWGN:POWer:SUM?**

Queries the overall power of the noise/interferer signal plus useful signal

**Return values:**

<Sum> float  
 Range: -145 to 20  
 Increment: 0.01  
 \*RST: 0

**Example:** see [Example "To generate an additive noise signal"](#) on page 1018

**Usage:** Query only

**Manual operation:** See ["Carrier + Noise Power, Signal + Noise Power \(System Bandwidth\), Carrier + Interferer Power, Signal + Interferer Power"](#) on page 439

---

**[[:SOURce<hw>]:AWGN:POWer:SUM:PEP?**

Queries the peak envelope power of the overall signal comprised of noise signal plus useful signal.

**Return values:**

<Pep> float  
 Range: -145 to 20  
 Increment: 0.01  
 \*RST: 0

**Example:** see [Example "To generate an additive noise signal"](#) on page 1018



**Usage:** Query only

**Manual operation:** See ["Carrier + Noise PEP, Signal + Noise PEP \(Total Bandwidth\), Carrier + Interferer PEP, Signal + Interferer PEP"](#) on page 439

**[ :SOURce<hw>]:AWGN:FREQUENCY:CENTer:OFFSet <CenterFreqOffs>**

Defines the frequency offset of the noise signal relative to the carrier center frequency.

**Parameters:**

<CenterFreqOffs> float  
 Range: -40E6 to 40E6  
 Increment: 0.01  
 \*RST: 0

**Example:** See [Example "To generate a pure noise signal"](#) on page 1017.

**Manual operation:** See ["Center Frequency Offset"](#) on page 434

**[ :SOURce<hw>]:AWGN:FREQUENCY:TARGet <Target>**

Sets the desired frequency of the sine wave.

**Parameters:**

<Target> float  
 Range: -40E6 to 40E6  
 Increment: 0.01  
 \*RST: 0

**Example:** see [Example "To generate a CW interferer signal"](#) on page 1018

**Manual operation:** See ["Target CW Frequency Offset"](#) on page 434

**[ :SOURce<hw>]:AWGN:FREQUENCY:RESult?**

Queries the actual frequency of the sine wave.

**Return values:**

<Result> float  
 Range: -40E6 to 40E6  
 Increment: 0.01  
 \*RST: 0

**Example:** see [Example "To generate a CW interferer signal"](#) on page 1018

**Usage:** Query only

**Manual operation:** See ["Resulting CW Frequency Offset"](#) on page 440

### 14.19.3 SOURce:BBIN subsystem

The SOURce:BBIN subsystem contains the commands for setting the external digital baseband signal.

In **Standard mode**, the external baseband signal A can be routed to path A, path B, or both paths. The external baseband signal B can be routed to path B only.

#### Suffixes in the keywords ENTity<ch> and SOURce<hw>

You can address multiple entities configurations by using the SCPI commands starting with the keyword SOURce or the alias commands starting with the keyword ENTity.

**Table 14-2: Value ranges of the suffixes ENTity<ch> and SOURce<hw> in advanced configuration with multiple entities**

SCPI Syntax	ENTity<ch>	SOURce<hw>
SOURce<hw>:BBIN:...	-	1 to 4
ENTity<ch>:SOURce<hw>:BBIN:...	1 to 4	1 to 4



See also [Section 14.3, "SCPI command aliases for advanced mode with multiple entities"](#), on page 896.

Suffix	Value range	Description
CHANnel<ch0>	0 to 7	Channel number Up to 8 channels per HS DIG I/Q interface and max. 8 channels for both interfaces.

#### Required options

See ["Required Options"](#) on page 151

See also [Section 4.3.4, "Supported digital interfaces and system configuration"](#), on page 113.

#### Example: Applying an external digital baseband signal (DIG I/Q)

An external digital signal must be applied at the DIG I/Q connectors.

```
// Use the external signal supplied at the CODER 1 interface.
SOURce1:BBIN:DIGital:SOURce CODER1

// SOURce1:BBIN:DIGital:IQSWap:STATe 1

// Set the sample rate source and query the value.
SOURce1:BBIN:SRATe:SOURce DIN
SOURce1:BBIN:SRATe:ACTual? 100000000
SOURce1:BBIN:STATe ON

// enable automatic adjustment of the baseband input signal
SOURce1:BBIN:DIGital:ASETting:STATe ON
```

```

SOURce1:BBIN:MPERiod 10s
SOURce1:BBIN:ALEVel:EXECute
SOURce1:BBIN:CFACTOR?
SOURce1:BBIN:POWer:PEAK?
SOURce1:BBIN:POWer:RMS?

// monitor the signal
SOURce1:BBIN:OLOad:STATe?
// 0, i.e. no overflow detected
SOURce1:BBIN:OLOad:HOLD:RESet
SOURce1:BBIN:OLOad:HOLD:STATe?

```

### Example: Applying an external digital baseband signal (HS DIG I/Q)

An external digital signal must be applied at the HS DIG I/Q connectors.

```

SOURce1:BBIN:DIGital:SOURce CODER1
SOURce1:BBIN:DIGital:INTerface HSD

SOURce1:BBIN:STATe 1

SOURce1:BBIN:DIGital:INTerface HSD
SOURce1:BBIN:SRATe:SOURce? HSD
SOURce1:BBIN:CHANnel0:NAME?
SOURce1:BBIN:CHANnel0:SRATe?
// 100000000
SOURce1:BBIN:CHANnel0:POWer:CFACTOR 0.5
SOURce1:BBIN:CHANnel0:POWer:PEAK 3
SOURce1:BBIN:CHANnel0:POWer:RMS?
// 2.5
SOURce1:BBIN:CHANnel0:BB:STATe 1
SOURce1:BBIN:SRATe:SUM?
// 100000000
SOURce1:BBIN:SRATe:MAX?
// 1250000000

// Set the sample rate per channel.
SOURce1:BBIN:SRATe:SOURce USER
SOURce1:BBIN:CHANnel0:SRATe 500000000
SOURce1:BBIN:SRATe:SUM?
// 500000000

SOURce1:BBIN:MPERiod 2
SOURce1:BBIN:ALEVel:EXECute

[:SOURce<hw>]:BBIN:STATe..... 1028
[:SOURce<hw>]:BBIN:DIGital:SOURce..... 1028
[:SOURce<hw>]:BBIN:DIGital:INTerface..... 1029
[:SOURce<hw>]:BBIN:CDEVice?..... 1029
[:SOURce<hw>]:BBIN:CHANnel<ch0>:BB:STATe..... 1029

```

<code>[SOURce&lt;hw&gt;]:BBIN:CHANnel&lt;ch0&gt;:NAME</code> .....	1029
<code>[SOURce&lt;hw&gt;]:BBIN:CHANnel&lt;ch0&gt;:POWer:CFActor</code> .....	1030
<code>[SOURce&lt;hw&gt;]:BBIN:CHANnel&lt;ch0&gt;:POWer:PEAK</code> .....	1030
<code>[SOURce&lt;hw&gt;]:BBIN:CHANnel&lt;ch0&gt;:POWer:RMS</code> .....	1030
<code>[SOURce&lt;hw&gt;]:BBIN:CHANnel&lt;ch0&gt;:SRATe</code> .....	1031
<code>[SOURce&lt;hw&gt;]:BBIN:IQSWap[:STATe]</code> .....	1031
<code>[SOURce&lt;hw&gt;]:BBIN:MODE</code> .....	1031
<code>[SOURce&lt;hw&gt;]:BBIN:SRATe:SOURce</code> .....	1032
<code>[SOURce&lt;hw&gt;]:BBIN:SRATe:SUM?</code> .....	1032
<code>[SOURce&lt;hw&gt;]:BBIN:SRATe:MAX?</code> .....	1032
<code>[SOURce&lt;hw&gt;]:BBIN:SRATe[:ACTual]</code> .....	1033
<code>[SOURce&lt;hw&gt;]:BBIN:DIGital:ASETting:STATe</code> .....	1033
<code>[SOURce&lt;hw&gt;]:BBIN:MPERiod</code> .....	1033
<code>[SOURce&lt;hw&gt;]:BBIN:ALEVel:EXECute</code> .....	1034
<code>[SOURce&lt;hw&gt;]:BBIN:POWer:CFActor</code> .....	1034
<code>[SOURce&lt;hw&gt;]:BBIN:POWer:PEAK</code> .....	1034
<code>[SOURce&lt;hw&gt;]:BBIN:POWer:RMS?</code> .....	1035
<code>[SOURce&lt;hw&gt;]:BBIN:OLOad:STATe?</code> .....	1035
<code>[SOURce&lt;hw&gt;]:BBIN:OLOad:HOLD:STATe?</code> .....	1035
<code>[SOURce&lt;hw&gt;]:BBIN:OLOad:HOLD:RESet</code> .....	1036

---

#### `[SOURce<hw>]:BBIN:STATe <State>`

Enables feeding of an external digital signal into the signal path.

##### Parameters:

<State>            1 | ON | 0 | OFF  
 \*RST:            0

**Example:**        See [Example "Applying an external digital baseband signal \(DIG I/Q\)"](#) on page 1026.

**Manual operation:**    See ["State"](#) on page 154

---

#### `[SOURce<hw>]:BBIN:DIGital:SOURce <DigInpSource>`

Defines the connector used as an external signal source.

##### Parameters:

<DigInpSource>    CODER1 | FADER1 | FADER2 | CODER2  
 \*RST:            CODER1

**Example:**        See [Example "Applying an external digital baseband signal \(DIG I/Q\)"](#) on page 1026.

**Options:**        FADER1|FADER2 require R&S SMW-B14

**Manual operation:**    See ["Connector"](#) on page 154

---

**[:SOURce<hw>]:BBIN:DIGital:INTerface <BBinDigInterfac>**

Selects the input connector at that the signal is fed.

**Parameters:**

<BBinDigInterfac> DIGital | HSDin | DIGital | HSDin  
**DIN**  
 DIG I/Q  
**HSDin**  
 HS DIG I/Q  
 \*RST: HSDin

**Example:** See [Example "Applying an external digital baseband signal \(HS DIG I/Q\)"](#) on page 1027.

**Options:** R&S SMW-B9

**Manual operation:** See ["Interface"](#) on page 161

---

**[:SOURce<hw>]:BBIN:CDEvice?**

Indicates the ID of an externally connected Rohde & Schwarz Instrument or Rohde & Schwarz device.

**Return values:**

<CDevice> string  
 "None" - no device is connected.

**Example:** SOURce:BBIN:CDEvice?  
 Queries the connected device ID.

**Usage:** Query only

**Manual operation:** See ["Connected Device"](#) on page 154

---

**[:SOURce<hw>]:BBIN:CHANnel<ch0>:BB:STATe <BbinIqHsChanSta>**

Activates the channel.

**Parameters:**

<BbinIqHsChanSta> 1 | ON | 0 | OFF  
 \*RST: 0

**Example:** See [Example "Applying an external digital baseband signal \(HS DIG I/Q\)"](#) on page 1027.

**Options:** R&S SMW-B9

**Manual operation:** See ["BB"](#) on page 163

---

**[:SOURce<hw>]:BBIN:CHANnel<ch0>:NAME <BbinIqHsChanNam>**

Queries the channel name.

**Parameters:**

<BbinIqHsChanNam> string

**Example:** See [Example "Applying an external digital baseband signal \(HS DIG I/Q\)"](#) on page 1027.

**Options:** R&S SMW-B9

**Manual operation:** See ["Name"](#) on page 162

**[[:SOURce<hw>]:BBIN:CHANnel<ch0>:POWER:CFACTOR <BbinIqHsChCrFac>**

Sets the crest factor of the individual channels.

**Parameters:**

<BbinIqHsChCrFac> float

Range: 0 to 30

Increment: 0.01

\*RST: 0

**Example:** See [Example "Applying an external digital baseband signal \(HS DIG I/Q\)"](#) on page 1027.

**Options:** R&S SMW-B9

**Manual operation:** See ["Crest Factor"](#) on page 163

**[[:SOURce<hw>]:BBIN:CHANnel<ch0>:POWER:PEAK <BbinHsChPoPeak>**

Sets the peak level per channel.

**Parameters:**

<BbinHsChPoPeak> float

Range: -60 to 3.02

Increment: 0.01

\*RST: 0

**Example:** See [Example "Applying an external digital baseband signal \(HS DIG I/Q\)"](#) on page 1027.

**Options:** R&S SMW-B9

**Manual operation:** See ["Peak Level"](#) on page 163

**[[:SOURce<hw>]:BBIN:CHANnel<ch0>:POWER:RMS <BbinIqHsChPoRms>**

Queries the estimated RMS level.

**Parameters:**

<BbinIqHsChPoRms> float

Range: -100 to 10

Increment: 0.01

\*RST: 0

**Example:** See [Example "Applying an external digital baseband signal \(HS DIG I/Q\)"](#) on page 1027.

**Options:** R&S SMW-B9

**Manual operation:** See ["Level"](#) on page 163

**[ :SOURce<hw> ]:BBIN:CHANnel<ch0>:SRATe <BbinIqHsChSaRat>**

Queries the sample rate per channel.

**Parameters:**

<BbinIqHsChSaRat> float

Range: 400 to 250E6 ("System Config > Mode = Advanced")/1250E6 ("System Config > Mode = Standard")

Increment: 0.001

\*RST: 100E6

See also [Section 4.3.4, "Supported digital interfaces and system configuration"](#), on page 113.

**Example:** See [Example "Applying an external digital baseband signal \(HS DIG I/Q\)"](#) on page 1027.

**Options:** R&S SMW-B9  
Setting the sample rate requires R&S SMW-K556.

**Manual operation:** See ["Sample Rate"](#) on page 163

**[ :SOURce<hw> ]:BBIN:IQSWap[:STATe] <State>**

If activated, swaps the I and Q channel.

**Parameters:**

<State> 1 | ON | 0 | OFF

\*RST: 0

**Example:** See [Example "Applying an external digital baseband signal \(DIG I/Q\)"](#) on page 1026.

**Manual operation:** See ["I/Q Swap"](#) on page 154

**[ :SOURce<hw> ]:BBIN:MODE <Mode>**

Defines that a digital external signal is applied.

**Parameters:**

<Mode> DIGital

\*RST: DIGital

**Example:** See [Example "Applying an external digital baseband signal \(DIG I/Q\)"](#) on page 1026.

---

**[ :SOURce<hw>]:BBIN:SRATe:SOURce <Source>**

Selects whether the sample rate is estimated based on the digital input signal or is a user-defined value.

**Parameters:**

<Source>                   DIN | HSDin | USER

**USER**

Enabled for [ :SOURce<hw>]:BBIN:DIGital:INTerface  
DIN.

Set the value with [ :SOURce<hw>]:BBIN:SRATe[:ACTual].

**DIN**

Enabled for [ :SOURce<hw>]:BBIN:DIGital:SOURce  
CODER1 | CODER2.

Estimates the sample rate based on the digital input signal.

**HSDin**

Enabled for [ :SOURce<hw>]:BBIN:DIGital:INTerface  
HSDin.

\*RST:           HSDin

\*RST: USER (R&S SMW-B10)/HSDin (R&S SMW-B9)

**Example:**                See [Example "Applying an external digital baseband signal \(DIG I/Q\)"](#) on page 1026.

**Options:**                HSDin requires R&S SMW-B9

**Manual operation:**    See ["Sample Rate Source"](#) on page 155

---

**[ :SOURce<hw>]:BBIN:SRATe:SUM?**

Queries the sum of the sample rates of all active channels.

**Return values:**

<DigIqHsOutSRSum> integer

Range:        0 to depends on settings

\*RST:        0

**Example:**                See [Example "Applying an external digital baseband signal \(HS DIG I/Q\)"](#) on page 1027.

**Usage:**                 Query only

**Options:**                R&S SMW-B9

**Manual operation:**    See ["Aggregated Link Sample Rate"](#) on page 163

---

**[ :SOURce<hw>]:BBIN:SRATe:MAX?**

Queries the maximum sample rate.



**Return values:**`<DigIqHsOutSRMax>` integer

Range: 1050E6 to 1250E6

\*RST: 1050E6

**Example:**See [Example "Applying an external digital baseband signal \(HS DIG I/Q\)"](#) on page 1027.**Usage:**

Query only

**Options:**

R&amp;S SMW-B9

**Manual operation:**See ["Aggregated Link Sample Rate"](#) on page 163**`[:SOURce<hw>]:BBIN:SRATe[:ACTual] <Actual>`**

Sets the sample rate of the external digital baseband signal.

**Parameters:**`<Actual>`

float

Range: 25E6 to max (depends on the installed options)

Increment: 5E6

\*RST: 100E6

max = 200E6 (R&amp;S SMW-B10)

max = 250E6 (R&amp;S SMW-B9)

max = 100E6|200E6 (for `[:SOURce<hw>]:BBIN:DIGital:``SOURceFADER1 | FADER2`)See also [Section 4.3.4, "Supported digital interfaces and system configuration"](#), on page 113.**Example:**See [Example "Applying an external digital baseband signal \(DIG I/Q\)"](#) on page 1026.**Manual operation:**See ["Sample Rate Value"](#) on page 156**`[:SOURce<hw>]:BBIN:DIGital:ASETting:STATe <State>`**

Activates automatic adjustment of the baseband input signal.

**Parameters:**`<State>`

1 | ON | 0 | OFF

\*RST: 1

**Example:**See [Example "Applying an external digital baseband signal \(DIG I/Q\)"](#) on page 1026.**Manual operation:**See ["DIG IQ Auto Setting"](#) on page 156**`[:SOURce<hw>]:BBIN:MPERiod <MPeriod>`**For `[:SOURce<hw>]:BBIN:DIGital:SOURce` CODER1 | CODER2

Sets the recording duration for measuring the baseband input signal by executed [:SOURce<hw>]:BBIN:ALEVel:EXECute.

**Parameters:**

<MPeriod> integer  
 Range: 1 to 32  
 \*RST: 2  
 Default unit: s

**Example:** See [Example "Applying an external digital baseband signal \(DIG I/Q\)"](#) on page 1026.

**Manual operation:** See ["Measurement Period"](#) on page 156

**[:SOURce<hw>]:BBIN:ALEVel:EXECute**

For [:SOURce<hw>]:BBIN:DIGital:SOURce CODER1 | CODER2

Starts measuring the input signal. The measurement estimates the crest factor, peak and RMS level.

**Example:** See [Example "Applying an external digital baseband signal \(DIG I/Q\)"](#) on page 1026.

**Usage:** Event

**Manual operation:** See ["Auto Level Set"](#) on page 157

**[:SOURce<hw>]:BBIN:POWER:CFACTOR <CFactor>**

Sets the crest factor of the external baseband signal.

**Parameters:**

<CFactor> float  
 Range: 0 to 30  
 Increment: 0.01  
 \*RST: 0  
 Default unit: dB

**Example:** See [Example "Applying an external digital baseband signal \(DIG I/Q\)"](#) on page 1026.

**Manual operation:** See ["Crest Factor"](#) on page 157

**[:SOURce<hw>]:BBIN:POWER:PEAK <Peak>**

Peak level of the external baseband signal relative to full scale of 0.5 V (in terms of dB full scale).

**Parameters:**

<Peak> float  
 Range: -60 to 3.02  
 Increment: 0.01  
 \*RST: 0  
 Default unit: dBfs

**Example:** See [Example "Applying an external digital baseband signal \(DIG I/Q\)"](#) on page 1026

**Manual operation:** See ["Peak Level"](#) on page 157

**[ :SOURce<hw>]:BBIN:POWER:RMS?**

Queries the RMS level of the external digital baseband signal.

**Return values:**

<Rms> float  
 Range: -100 to 10  
 Increment: 0.01  
 \*RST: 0

**Example:** See [Example "Applying an external digital baseband signal \(DIG I/Q\)"](#) on page 1026.

**Usage:** Query only

**Manual operation:** See ["Level"](#) on page 157

**[ :SOURce<hw>]:BBIN:OLOad:STATe?**

Queries the current overflow state.

**Return values:**

<State> 1 | ON | 0 | OFF  
 \*RST: 0

**Example:** see [Example "Applying an external digital baseband signal \(DIG I/Q\)"](#) on page 1026

**Usage:** Query only

**Manual operation:** See ["Signal Monitoring"](#) on page 158

**[ :SOURce<hw>]:BBIN:OLOad:HOLD:STATe?**

Queries an overload since the last reset for evaluating the measurement.

**Return values:**

<State> 1 | ON | 0 | OFF  
 \*RST: 0

**Example:** See [\[:SOURce<hw>\]:BBIN:OLOad:STATe?](#) on page 1035

**Usage:** Query only

**Manual operation:** See "Signal Monitoring" on page 158

---

**[ :SOURce<hw>]:BBIN:OLOad:HOLD:RESet**

Reset of the Overload Hold indication.

**Example:** see [ :SOURce<hw>]:BBIN:OLOad:STATe? on page 1035

**Usage:** Event

#### 14.19.4 Analog modulation subsystems

The subsystems in this section describe all commands for analog modulation of the RF signal. Divided in separate sections, you can configure amplitude modulation (AM), frequency modulation (FM), phase modulation (PhiM) and pulse modulation (PULM).

You can perform each of the modulations either with an internally generated modulation signal or with an externally applied signal.

To configure the internal signal, use the commands listed in [Section 14.19.12, "SOURce:LFOutput subsystem"](#), on page 1227.

For more information:

See [Section 8.11, "Analog modulations"](#), on page 546.

##### 14.19.4.1 SOURce:MODulation subsystem

The command in this subsystem allows you to disable all active modulations at once, and, vice versa, to restore the last active ones.

---

**[ :SOURce<hw>]:MODulation[:ALL][:STATe] <State>**

Activates all modulations that were active before the last switching off.

**Parameters:**

<State>            1 | ON | 0 | OFF  
 \*RST:            0

**Example:**

```

SOURce1:AM1:DEPTH 30
SOURce1:AM1:SOURce LF1
SOURce1:AM1:STATe 1
SOURce1:F1:DEVIation 1000
SOURce1:F1:STATe 1
// disable both modulation
SOURce1:MODulation:ALL:STATe 0
SOURce1:AM1:STATe?
// 0
SOURce1:F1:STATe?
// 0
// enable both modulation
SOURce1:MODulation:ALL:STATe 1
SOURce1:AM1:STATe?
// 1
SOURce1:F1:STATe?
// 1

```

**Manual operation:** See "[MOD ON/OFF]" on page 556

#### 14.19.4.2 SOURce:AM subsystem

Option: R&S SMW-K720

The AM subsystem contains the commands for setting the amplitude modulation and also the broadband amplitude modulation.



Enabling amplitude modulation disables ARB, I/Q modulation, digital modulation and all digital standards.

The following examples show some variants for generating AM signals.

##### **Example: Creating an amplitude modulated RF signal**

Using the internal LF generator, the following command sequence configures an amplitude-modulated signal.

```

// Reset the instrument to start from a defined state.
*RST

// Set RF frequency and amplitude
:SOURce1:FREQuency:CW 6000000000
:SOURce1:POWer:LEVel:IMMediate:AMPLitude -25

// Configure the modulation signal
:SOURce1:LFOutput1:SHAPE SINE
:SOURce1:LFOutput1:FREQuency 20000

// Configure the amplitude modulation settings and switch AM on
:SOURce1:AM1:SOURce LF1

```

```
:SOURCE1:AM1:DEPTH 30
:SOURCE1:AM:RATIO 40
:SOURCE1:AM1:DEVIATION:MODE UNC
:SOURCE1:AM1:STATE 1
```

### Example: Using combined LF signals

Using the internal LF generators of both paths, the following command sequences configure an amplitude-modulated signal with determined deviations depths.

```
// Configure the AM modulation settings with combined LF signal sources
:SOURCE1:AM1:SOURCE LF1
:SOURCE1:AM1:DEPTH 32
// Select the modulation signal source for the second path
:SOURCE1:AM2:SOURCE LF2
// Combine the signals of both paths with fixed total deviation depth
:SOURCE1:AM1:DEVIATION:MODE TOT
:SOURCE1:AM1:DEPTH:SUM 60

// Query the deviation depth of modulation signal in the second path
:SOURCE1:AM2:DEPTH?
// Response: 28

// Combine the signals of both paths with fixed ratio
:SOURCE1:AM1:DEVIATION:MODE RAT
:SOURCE1:AM1:RATIO 100
:SOURCE1:AM2:DEPTH 25

// Query the deviation depth of modulation signal in the first path
:SOURCE1:AM1:DEPTH?
// Response: 25

:SOURCE1:AM1:STATE 1
:SOURCE1:AM2:STATE 1
```

### Example: Using an external signal source

Using an external signal source, you can also determine whether you want to use only the AC component of the external modulation signal.

```
// Reset the instrument to start from a defined state
*RST

// Set frequency and amplitude
:SOURCE1:FREQUENCY:CW 6000000000
:SOURCE1:POWER:LEVEL:IMMEDIATE:AMPLITUDE -25

// Configure the amplitude modulation settings and turn on AM
:SOURCE1:AM1:SOURCE EXT1
:SOURCE1:AM1:DEPTH 40

// Query the input sensitivity at the external modulation input
```

```

:SOURce1:AM1:SENSitivity?
// Response: 40
// Since the voltage value for full modulation is 1V,
// the resulting sensitivity is precisely 50%/V.
// This value is assigned to the voltage value for full
// modulation of the input.

// Select the coupling mode AC for external amplitude modulation
:SOURce1:INPut:MODext:COUPling1 AC

// Switch on AM and RF signal output
:SOURce1:AM1:STATe 1
:OUTPut1:STATe 1

```

The following commands are available:

<a href="#">[:SOURce&lt;hw&gt;]:AM&lt;ch&gt;:STATe.....</a>	1039
<a href="#">[:SOURce&lt;hw&gt;]:AM&lt;ch&gt;:SOURce.....</a>	1039
<a href="#">[:SOURce&lt;hw&gt;]:AM&lt;ch&gt;[:DEPTH].....</a>	1040
<a href="#">[:SOURce&lt;hw&gt;]:AM:DEPTH:SUM.....</a>	1040
<a href="#">[:SOURce&lt;hw&gt;]:AM:DEVIation:MODE.....</a>	1040
<a href="#">[:SOURce&lt;hw&gt;]:AM:RATIo.....</a>	1041
<a href="#">[:SOURce&lt;hw&gt;]:AM&lt;ch&gt;:SENSitivity.....</a>	1041

---

#### **[:SOURce<hw>]:AM<ch>:STATe <State>**

Activates amplitude modulation.

##### **Parameters:**

<State>            1 | ON | 0 | OFF  
 \*RST:            0

**Example:**        See [Example "Creating an amplitude modulated RF signal"](#)  
 on page 1037.

**Manual operation:** See ["State"](#) on page 559

---

#### **[:SOURce<hw>]:AM<ch>:SOURce <Source>**

Selects the modulation source for amplitude modulation.

##### **Parameters:**

<Source>            LF1 | LF2 | NOISe | EXT1 | EXT2 | EXTernal | INTernal  
**LF1|LF2**  
 Uses an internally generated LF signal.  
**EXT1|EXT2**  
 Uses an externally supplied LF signal.  
**NOISe**  
 Uses the internally generated noise signal.  
**INTernal**  
 Uses the internally generated signal of LF1.

**EXtErnal**

Uses an external LF signal (EXT1).

\*RST: LF1 <AM1>; LF2 <AM2>

**Example:** See [Example "Creating an amplitude modulated RF signal"](#) on page 1037.

**Manual operation:** See ["Source"](#) on page 560

**[[:SOURce<hw>]:AM<ch>[:DEPTH] <Depth>**

Sets the depth of the amplitude modulation in percent.

**Suffix:**

<ch> 1..2  
Modulation signal channel

**Parameters:**

<Depth> float  
Range: 0 to 100

**Example:** See [Example "Creating an amplitude modulated RF signal"](#) on page 1037.

**Manual operation:** See ["Depth"](#) on page 563

**[[:SOURce<hw>]:AM:DEPTH:SUM <AmDepthSum>**

Sets the total depth of the LF signal when using combined signal sources in amplitude modulation.

**Parameters:**

<AmDepthSum> float  
Range: 0 to 100  
Increment: 0.1  
\*RST: 30

**Example:** See [Example "Using combined LF signals"](#) on page 1038.

**Manual operation:** See ["Total Depth"](#) on page 564

**[[:SOURce<hw>]:AM:DEVIation:MODE <AmDevMode>**

Selects the coupling mode. The coupling mode parameter also determines the mode for fixing the total depth.

**Parameters:**

<AmDevMode> UNCOupled | TOTal | RATio

**UNCOupled**

Does not couple the LF signals.

The deviation depth values of both paths are independent.



**TOTal**

Couples the deviation depth of both paths.

**RATio**

Couples the deviation depth ratio of both paths

\*RST: UNCOupled

**Example:** See [Example "Using combined LF signals"](#) on page 1038.

**Manual operation:** See ["Deviation Mode"](#) on page 563

**[:SOURce<hw>]:AM:RATio <Ratio>**

Sets the deviation ratio (path#2 to path#1) in percent.

**Parameters:**

<Ratio> float  
 Range: 0 to 100  
 Increment: 0.1  
 \*RST: 100

**Example:** See [Example "Creating an amplitude modulated RF signal"](#) on page 1037.

**Manual operation:** See ["Ratio Path2/Path1"](#) on page 564

**[:SOURce<hw>]:AM<ch>:SENSitivity <Sensitivity>**

Sets the sensitivity of the external signal source for amplitude modulation in %/V.

**Parameters:**

<Sensitivity> float  
 Range: 0 to 100  
 Increment: 0.1  
 \*RST: 30

**Example:** See [Example "Using an external signal source"](#) on page 1038.

**Manual operation:** See ["Sensitivity"](#) on page 563

#### 14.19.4.3 SOURce:FM subsystem

Option: R&S SMW-K720

The FM subsystem contains the commands for setting the frequency modulation.

**Example: Creating a frequency modulated RF signal**

Using the internal LF generator, the following command sequence configures a frequency-modulated signal.

```
// Reset the instrument to start from a defined state
*RST
```

```
// Set RF frequency and amplitude
SOURcel:FREQuency:CW 6000000000
SOURcel:POWer:LEVel:IMMediate:AMPLitude -25

// Configure the modulation signal
SOURcel:LFOutput1:SHAPE SINE
SOURcel:LFOutput1:FREQuency 20000

// Configure the frequency modulation settings and switch FM on
SOURcel:FM1:SOURce LF1
SOURcel:FM1:DEVIation 1000
SOURcel:FM:RATio 40
SOURcel:FM:MODe LNOise
SOURcel:FM1:STATe 1

// Switch on LF and RF signal output
SOURcel:LFOutput1:STATe 1
OUTPut1:STATe 1
```

### Example: Using combined LF signals

Using the internal LF generators of both paths, the following command sequences configure a frequency-modulated signal with determined deviations.

```
// Configure the FM modulation settings with combined LF signal sources
SOURcel:FM1:SOURce LF1
SOURcel:FM1:DEVIation 1000
// Select the modulation signal source for the second path
SOURcel:FM2:SOURce LF2
// Combine the signals of both paths with fixed total deviation depth
SOURcel:FM1:DEVIation:MODe TOT
SOURcel:FM1:DEVIation:SUM 5000

// Query the deviation depth of modulation signal in the second path
SOURcel:FM2:DEVIation?
// Response: 4000

// Combine the signals of both paths with fixed ratio
SOURcel:FM1:DEVIation:MODe RAT
SOURcel:FM1:RATio 100
SOURcel:FM2:DEVIation 10000

// Query the deviation depth of modulation signal in the first path
SOURcel:AM1:DEVIation?
// Response: 1000

SOURcel:FM1:STATe 1
SOURcel:FM2:STATe 1
```

**Example: Using an external signal source**

Alternatively configure the frequency modulation settings with an external modulation signal.

```
// Reset the instrument to start from a defined state
*RST

// Set RF frequency and amplitude
SOURce1:FREQuency:CW 6000000000
SOURce1:POWer:LEVel:IMMediate:AMPLitude -25

// Configure the frequency modulation settings and switch FM on
SOURce1:FM1:SOURce EXT1
SOURce1:FM1:DEVIation 5000

// Query the input sensitivity at the external modulation input
:SOURce1:FM1:SENSitivity?
// Response: 1000
// since the voltage value for full modulation is 1V,
// the resulting sensitivity is precisely 5000 Hz/V.

// Switch on FM and RF signal output
SOURce1:FM1:STATe 1
OUTPut1:STATe 1
```

The following commands are available:

<a href="#">[:SOURce&lt;hw&gt;]:FM&lt;ch&gt;:STATe.....</a>	1043
<a href="#">[:SOURce&lt;hw&gt;]:FM&lt;ch&gt;[:DEVIation].....</a>	1044
<a href="#">[:SOURce&lt;hw&gt;]:FM&lt;ch&gt;:SOURce.....</a>	1044
<a href="#">[:SOURce&lt;hw&gt;]:FM:DEVIation:MODE.....</a>	1045
<a href="#">[:SOURce&lt;hw&gt;]:FM:DEVIation:SUM.....</a>	1045
<a href="#">[:SOURce&lt;hw&gt;]:FM:RATio.....</a>	1045
<a href="#">[:SOURce&lt;hw&gt;]:FM:MODE.....</a>	1046
<a href="#">[:SOURce&lt;hw&gt;]:FM:SENSitivity?.....</a>	1046

**[\[:SOURce<hw>\]:FM<ch>:STATe <State>](#)**

Activates frequency modulation.

**Suffix:**

FM<ch>                    1..2  
                              determines the modulation signal channel.

**Parameters:**

<State>                    1 | ON | 0 | OFF  
\*RST:                      0

**Example:**                See [Example "Creating a frequency modulated RF signal"](#)  
                              on page 1041.

**Manual operation:**    See ["State"](#) on page 559

---

**[[:SOURce<hw>]:FM<ch>[:DEVIation] <Deviation>**

Sets the modulation deviation of the frequency modulation in Hz.

**Suffix:**

FM<ch>                    1|2  
 Modulation signal channel

**Parameters:**

<Deviation>            float  
 The maximum deviation depends on the RF frequency and the selected modulation mode (see the specification document).  
 Range:        0 to max  
 Increment:   0.01  
 \*RST:        1E3

**Example:**            See [Example "Creating a frequency modulated RF signal"](#) on page 1041.

**Manual operation:** See ["Deviation"](#) on page 560

---

**[[:SOURce<hw>]:FM<ch>:SOURce <Source>**

Selects the modulation source for frequency modulation.

**Suffix:**

FM<ch>                    1|2  
 Modulation signal channel.

**Parameters:**

<Source>                INTernal | EXTernal | LF1 | LF2 | NOISe | EXT1 | EXT2 | INTB  
**LF1|LF2**  
 Uses an internally generated LF signal.  
**INTernal = LF1**  
 Works like LF1  
**EXTernal**  
 Works like EXT1  
**EXT1|EXT2**  
 Uses an externally supplied LF signal.  
**NOISe**  
 Uses the internally generated noise signal.  
**INTB**  
 Uses the internal baseband signal.  
 \*RST:        LF1 <FM1>; LF2 <FM2>

**Example:**            See [Example "Creating a frequency modulated RF signal"](#) on page 1041.

**Options:**            INTB requires R&S SMW-B9

**Manual operation:** See ["Source"](#) on page 560

---

**[[:SOURce<hw>]:FM:DEVIation:MODE <FmDevMode>**

Selects the coupling mode. The coupling mode parameter also determines the mode for fixing the total deviation.

**Parameters:**

<FmDevMode>      UNCOupled | TOTal | RATio

**UNCOupled**

Does not couple the LF signals.

The deviation values of both paths are independent.

**TOTal**

Couples the deviation of both paths.

**RATio**

Couples the deviation ratio of both paths

\*RST:            UNCOupled

**Example:**            See [Example "Using combined LF signals"](#) on page 1042.

**Manual operation:**    See ["Deviation Mode"](#) on page 561

---

**[[:SOURce<hw>]:FM:DEVIation:SUM <FmDevSum>**

Sets the total deviation of the LF signal when using combined signal sources in frequency modulation.

**Parameters:**

<FmDevSum>            float  
                               Range:      0 to 40E6  
                               Increment: 0.01  
                               \*RST:      1E3

**Example:**            See [Example "Using combined LF signals"](#) on page 1042.

**Manual operation:**    See ["Total Deviation"](#) on page 561

---

**[[:SOURce<hw>]:FM:RATio <Ratio>**

Sets the deviation ratio (path2 to path1) in percent.

**Parameters:**

<Ratio>                 float  
                               Range:      0 to 100  
                               Increment: 0.1  
                               \*RST:      100

**Example:**            See [Example "Creating a frequency modulated RF signal"](#) on page 1041.

**Manual operation:**    See ["Ratio Path2/Path1"](#) on page 561

---

**[:SOURce<hw>]:FM:MODE <Mode>**

Selects the mode for the frequency modulation.

**Parameters:**

<Mode>                    NORMal | LNOise

**NORMal**

The maximum range for modulation bandwidth and FM deviation is available.

**LNOise**

Frequency modulation with phase noise and spurious characteristics close to CW mode. The range for modulation bandwidth and FM deviation is reduced (see the specifications document).

\*RST:            NORMal

**Example:**            See [Example "Creating a frequency modulated RF signal"](#) on page 1041.

**Manual operation:** See ["Mode"](#) on page 561

---

**[:SOURce<hw>]:FM:SENSitivity?**

Queries the sensitivity of the externally supplied signal for frequency modulation. The sensitivity depends on the set modulation deviation.

**Return values:**

<Sensitivity>            float

Sensitivity in Hz/V.

It is assigned to the voltage value for full modulation of the input.

Range:            0 to max

Increment:        0.01

**Example:**            See [Example "Using an external signal source"](#) on page 1043.

**Usage:**                Query only

#### 14.19.4.4 SOURce:PM subsystem

Option: R&S SMW-K720

The PM subsystem contains the commands for setting the phase modulation. You can configure the internal modulation source (LF generator) with the commands listed in [Section 14.19.12, "SOURce:LFOutput subsystem"](#), on page 1227.

For information about the required options, see [Section 8.11.1, "Required options"](#), on page 548.

**Example: Performing phase modulation**

The following example shows a command sequence to perform phase modulation.

```

// Reset the instrument to start from an initial state
*RST; *CLS

// Set the RF signal frequency and level
:SOURce:FREQuency:CW 4000000000
:SOURce:POWer:LEVel:IMMediate:AMPLitude -25

// Configure the phase modulation settings
:SOURcel:LFOutput1:SHAPE SINE
:SOURcel:LFOutput1:FREQuency 1000

// Select the LF signal generated by the internal modulation generator
// or the internally generated noise signal
:SOURcel:PM1:DEVIation 1
:SOURcel:PM1:SOURce LF1
// :SOURcel:PM1:SOURce INTernal
// :SOURcel:PM1:SOURce NOISE
:SOURcel:PM1:RATio 40
:SOURcel:PM1:MODE HBAN

// Alternatively configure the phase modulation settings for an
// external modulation source and query the input sensitivity.
:SOURcel:PM1:SOURce EXT1
// :SOURcel:PM1:SOURce EXTernal
:SOURcel:PM1:DEVIation 1
:SOURcel:PM1:SENSitivity?
// Response: 1
// since the voltage value for full modulation is 1V,
// the resulting sensitivity is precisely 1RAD/V.

// Activate the signal output
:SOURcel:PM1:STATe 1
:OUTPut1:STATe 1

```

### Example: Using combined LF signals

Using the internal LF generators of both paths, the following command sequences configure a phase-modulated signal with determined deviations.

```

// Configure the Phase modulation settings with combined LF signal sources
:SOURcel:PM1:SOURce LF1
:SOURcel:PM1:DEVIation 1.5
// Select the modulation signal source for the second path
:SOURcel:PM2:SOURce LF2
// Combine the signals of both paths with fixed total deviation depth
:SOURcel:PM1:DEVIation:MODE TOT
:SOURcel:PM1:DEVIation:SUM 2

// Query the deviation depth of the modulation signal in the second path
:SOURcel:PM2:DEVIation?
// Response: 0.5

```

```
// Combine the signals of both paths with fixed ratio
:SOURce1:PM1:DEVIation:MODE RAT
:SOURce1:PM1:RATio 80
:SOURce1:PM2:DEVIation?
// Response: 1.2

// Query the deviation depth of modulation signal in the first path
:SOURce1:PM1:DEVIation?
// Response: 1.5

:SOURce1:FM1:STATe 1
:SOURce1:FM2:STATe 1
```

The following commands are available:

<a href="#">[:SOURce&lt;hw&gt;]:PM&lt;ch&gt;:STATe</a> .....	1048
<a href="#">[:SOURce&lt;hw&gt;]:PM&lt;ch&gt;:SOURce</a> .....	1048
<a href="#">[:SOURce&lt;hw&gt;]:PM:MODE</a> .....	1049
<a href="#">[:SOURce&lt;hw&gt;]:PM:DEVIation:MODE</a> .....	1049
<a href="#">[:SOURce&lt;hw&gt;]:PM:DEVIation:SUM</a> .....	1050
<a href="#">[:SOURce&lt;hw&gt;]:PM:RATio</a> .....	1050
<a href="#">[:SOURce&lt;hw&gt;]:PM:SENSitivity?</a> .....	1050
<a href="#">[:SOURce]:PM&lt;ch&gt;[:DEVIation]</a> .....	1051

---

#### **[:SOURce<hw>]:PM<ch>:STATe <State>**

Activates phase modulation.

Activation of phase modulation deactivates frequency modulation.

##### **Suffix:**

PM<ch>                    1|2  
Sets the modulation signal channel.

##### **Parameters:**

<State>                    1 | ON | 0 | OFF  
\*RST:                    0

**Example:**                See [Example "Performing phase modulation"](#) on page 1046.

**Manual operation:**    See ["State"](#) on page 559

---

#### **[:SOURce<hw>]:PM<ch>:SOURce <Source>**

Selects the modulation source for phase modulation signal.

##### **Suffix:**

PM<ch>                    1|2  
Sets the modulation signal channel.

##### **Parameters:**

<Source>                    INTernal | EXTernal | LF1 | LF2 | NOISe | EXT1 | EXT2 | INTB



**LF1|LF2**

Uses an internally generated LF signal.

**EXT1|EXT2**

Uses an externally supplied LF signal.

**NOISe**

Uses the internally generated noise signal.

**INTernal**

Uses the internally generated signal of LF1.

**EXTernal**

Uses an external LF signal (EXT1).

**INTB**

Uses the internal baseband signal.

\*RST: LF1 <PM1>; LF2 <PM2>

**Example:** See [Example "Performing phase modulation"](#) on page 1046.

**Options:** INTB requires R&S SMW-B9

**Manual operation:** See ["Source"](#) on page 560

**[:SOURce<hw>]:PM:MODE <Mode>**

Selects the mode for the phase modulation.

**Parameters:**

<Mode> HBANdwidth | HDEViation | LNOise

**HBANdwidth**

Sets the maximum available bandwidth.

**HDEViation**

Sets the maximum range for  $\Phi$ M deviation.

**LNOise**

Selects a phase modulation mode with phase noise and spurious characteristics close to CW mode.

\*RST: HBANdwidth

**Example:** See [Example "Performing phase modulation"](#) on page 1046.

**Manual operation:** See ["Mode"](#) on page 563

**[:SOURce<hw>]:PM:DEViation:MODE <PmDevMode>**

Selects the coupling mode. The coupling mode parameter also determines the mode for fixing the total deviation.

**Parameters:**

<PmDevMode> UNCoupled | TOTal | RATIo

**UNCoupled**

Does not couple the LF signals.

The deviation values of both paths are independent.

**TOTal**

Couples the deviation of both paths.

**RATio**

Couples the deviation ratio of both paths

\*RST: UNCOupled

**Example:** See [Example "Using combined LF signals"](#) on page 1047

**Manual operation:** See ["Deviation Mode"](#) on page 562

**[:SOURce<hw>]:PM:DEVIation:SUM <PmDevSum>**

Sets the total deviation of the LF signal when using combined signal sources in phase modulation.

**Parameters:**

<PmDevSum> float  
 Range: 0 to max  
 Increment: 1E-6  
 \*RST: 1

**Example:** See [Example "Using combined LF signals"](#) on page 1047

**Manual operation:** See ["Total Deviation"](#) on page 562

**[:SOURce<hw>]:PM:RATio <Ratio>**

Sets the deviation ratio (path2 to path1) in percent.

**Parameters:**

<Ratio> float  
 Range: 0 to 100  
 Increment: 0.01  
 \*RST: 100

**Example:** See [Example "Performing phase modulation"](#) on page 1046.

**Manual operation:** See ["Ratio Path2/Path1"](#) on page 562

**[:SOURce<hw>]:PM:SENSitivity?**

Queries the sensitivity of the externally applied signal for phase modulation.

The returned value reports the sensitivity in RAD/V. It is assigned to the voltage value for full modulation of the input.

**Return values:**

<Sensitivity> float

**Example:** See [Example "Performing phase modulation"](#) on page 1046.

**Usage:** Query only

**[:SOURce]:PM<ch>[:DEVIation] <Deviation>**

Sets the modulation deviation of the phase modulation in RAD.

**Parameters:**

<Deviation> float  
 The maximal deviation depends on the RF frequency and the selected modulation mode (see the specifications document).  
 Range: 0 to max  
 Increment: 1  
 \*RST: 1  
 Default unit: RAD

**Example:** See [Example "Performing phase modulation"](#) on page 1046.

**Manual operation:** See ["Deviation"](#) on page 562

#### 14.19.4.5 SOURce:PULM subsystem

Option: see [Section 8.11.1, "Required options"](#), on page 548.

The PULM subsystem contains the commands for setting the pulse modulation.

- [Pulse modulation settings](#)..... 1051

##### **Pulse modulation settings**

With the commands described in this section, you can configure the settings for pulse modulation, select the trigger mode and determine delay times for the pulse modulation signal.

##### **Example: Perform pulse modulation**

The example shows a command sequence to perform pulse modulation.

```
// Reset the instrument to start from an initial state
*RST; *CLS

// Set the RF signal frequency and level
:SOURce:FREQuency:CW 4000000000
:SOURce:POWer:LEVel:IMMediate:AMPLitude -25

// Configure the pulse modulation settings
// Select the internal modulation generator,
// set trigger mode, select pulse mode, transition type

// and select the polarity of the internally generated pulse video output

:SOURce:PULM:SOURce INT
:SOURce:PULM:TRIGger:MODE SING
:SOURce:PULM:MODE DOUB
:SOURce:PULM:TTYPe SMO

:SOURce:PULM:OUTPut:VIDeo:POLarity INVerted
```

```

// Alternatively configure the pulse modulation settings for
// external modulation source
// Select the source, set the polarity of the external signal,
// select the impedance for the external pulse modulation input/
// for the external pulse modulation trigger input
:SOURce:PULM:SOURce EXT
:SOURce:PULM:POLarity NORMal
:SOURce:PULM:IMPedance G1K

:SOURce:PULM:TRIGger:EXternal:IMPedance G10K

// Configure the pulse generator settings
// Set pulse period, width, and delay
:SOURce:PULM:PERiod 10 us
:SOURce:PULM:WIDTh 8 us
:SOURce:PULM:DOUBle:WIDTh 0.0000012
:SOURce:PULM:DOUBle:DELay 0.0000045

// Activate the signal output
:SOURce:PGENERator:OUTPut:STATe 1
:SOURce:PULM:STATe 1
:OUTPut1:STATe 1

```

The following commands are available:

<code>[SOURce&lt;hw&gt;]:PULM:MODE</code> .....	1052
<code>[SOURce&lt;hw&gt;]:PULM:TRIGger:MODE</code> .....	1053
<code>[SOURce&lt;hw&gt;]:PULM:PERiod</code> .....	1053
<code>[SOURce&lt;hw&gt;]:PULM:WIDTh</code> .....	1053
<code>[SOURce&lt;hw&gt;]:PULM:DELay</code> .....	1053
<code>[SOURce&lt;hw&gt;]:PULM:DOUBle:DELay</code> .....	1054
<code>[SOURce&lt;hw&gt;]:PULM:DOUBle:WIDTh</code> .....	1054
<code>[SOURce&lt;hw&gt;]:PULM:DOUBle:STATe</code> .....	1054
<code>[SOURce&lt;hw&gt;]:PULM:STATe</code> .....	1054
<code>[SOURce&lt;hw&gt;]:PULM:SOURce</code> .....	1055
<code>[SOURce&lt;hw&gt;]:PULM:TTYPe</code> .....	1055
<code>[SOURce&lt;hw&gt;]:PULM:OUTPut:VIDeo:POLarity</code> .....	1055
<code>[SOURce&lt;hw&gt;]:PULM:POLarity</code> .....	1056
<code>[SOURce&lt;hw&gt;]:PULM:IMPedance</code> .....	1056
<code>[SOURce&lt;hw&gt;]:PULM:TRIGger:EXternal:IMPedance</code> .....	1056

---

**`[SOURce<hw>]:PULM:MODE <Mode>`**

Selects the mode for the pulse modulation.

**Parameters:**

`<Mode>`                    SINGle | DOUBle

**SINGle**  
Generates a single pulse.

**DOUBle**  
Generates two pulses within one pulse period.

\*RST:                    SINGle

**Example:** See [Example "Perform pulse modulation"](#) on page 1051.

**Manual operation:** See ["Pulse Mode"](#) on page 565

**[:SOURce<hw>]:PULM:TRIGger:MODE <Mode>**

Selects a trigger mode - auto, external, external single or external gated - for generating the modulation signal.

**Parameters:**

<Mode> AUTO | EXTeRnal | EGATe | ESINgle  
\*RST: AUTO

**Example:** See [Example "Perform pulse modulation"](#) on page 1051.

**Manual operation:** See ["Trigger Mode"](#) on page 565

**[:SOURce<hw>]:PULM:PERiod <Period>**

Sets the period of the generated pulse, that means the repetition frequency of the internally generated modulation signal.

**Parameters:**

<Period> float  
The minimum value depends on the installed options  
R&S SMW-K22 or R&S SMW-K23  
Range: 20E-9 to 100  
Increment: 5E-9  
\*RST: 10E-6

**Example:** See [Example "Perform pulse modulation"](#) on page 1051.

**Manual operation:** See ["Pulse Period"](#) on page 567

**[:SOURce<hw>]:PULM:WIDTh <Width>**

Sets the width of the generated pulse, that means the pulse length. It must be at least 20ns less than the set pulse period.

**Parameters:**

<Width> float  
Range: 20E-9 to 100  
Increment: 10E-9  
\*RST: 2E-6

**Example:** See [Example "Perform pulse modulation"](#) on page 1051.

**Manual operation:** See ["Pulse Width"](#) on page 567

**[:SOURce<hw>]:PULM:DELay <Delay>**

Sets the pulse delay.

**Parameters:**

<Delay> float  
 \*RST: 1ms

**Example:** See [Example "Perform pulse modulation"](#) on page 1051.

**Manual operation:** See ["Pulse Delay"](#) on page 568

**[[:SOURce<hw>]:PULM:DOUBLE:DELay <Delay>**

Sets the delay from the start of the first pulse to the start of the second pulse.

**Parameters:**

<Delay> float  
 \*RST: 1E-6

**Example:** See [Example "Perform pulse modulation"](#) on page 1051.

**Manual operation:** See ["Double Pulse Delay"](#) on page 568

**[[:SOURce<hw>]:PULM:DOUBLE:WIDTh <Width>**

Sets the width of the second pulse.

**Parameters:**

<Width> float  
 Increment: 5E-9

**Example:** See [Example "Perform pulse modulation"](#) on page 1051.

**Manual operation:** See ["Double Pulse Width"](#) on page 567

**[[:SOURce<hw>]:PULM:DOUBLE:STATe <State>**

Provided for backward compatibility with former Rohde & Schwarz signal generators.

Works like the command `[[:SOURce<hw>]:PULM:MODEDOUBLE`.

**Parameters:**

<State> 1 | ON | 0 | OFF  
 \*RST: 0

**[[:SOURce<hw>]:PULM:STATe <State>**

Activates pulse modulation.

**Parameters:**

<State> 1 | ON | 0 | OFF  
 \*RST: 0

**Example:** See [Example "Perform pulse modulation"](#) on page 1051.

**Manual operation:** See ["State"](#) on page 558

---

**[[:SOURce<hw>]:PULM:SOURce <Source>**

Selects between the internal (pulse generator) or an external pulse signal for the modulation.

**Parameters:**

<Source>            INTernal | EXTernal  
\*RST:            INTernal

**Example:**            See [Example "Perform pulse modulation"](#) on page 1051.

**Manual operation:** See ["Source"](#) on page 558

---

**[[:SOURce<hw>]:PULM:TTPe <Source>**

Sets the transition mode for the pulse signal.

**Parameters:**

<Source>            SMOothed | FAST  
**SMOothed**  
flattens the slew rate, resulting in longer rise/fall times.  
**FAST**  
enables fast transitions with shortest rise and fall times.  
\*RST:            FAST

**Example:**            See [Example "Perform pulse modulation"](#) on page 1051.

**Manual operation:** See ["Transition Type"](#) on page 558

---

**[[:SOURce<hw>]:PULM:OUTPut:VIDeo:POLarity <Polarity>**

Sets the polarity of the pulse video (modulating) signal, related to the RF (modulated) signal.

**Parameters:**

<Polarity>            NORMal | INVerted  
**NORMal**  
the video signal follows the RF signal, that means it is high when RF signal is high and vice versa.  
**INVerted**  
the video signal follows in inverted mode.  
\*RST:            NORMal

**Example:**            See [Example "Perform pulse modulation"](#) on page 1051.

**Manual operation:** See ["Video Polarity"](#) on page 558

**[:SOURce<hw>]:PULM:POLarity <Polarity>**

Sets the polarity of the externally applied modulation signal.

**Parameters:**

<Polarity>            NORMal | INVerted

**NORMal**

Suppresses the RF signal during the pulse pause.

**INVerted**

Suppresses the RF signal during the pulse.

\*RST:            NORMal

**Example:**            See [Example "Perform pulse modulation"](#) on page 1051.

**Manual operation:** See ["Polarity Pulse Input"](#) on page 559

**[:SOURce<hw>]:PULM:IMPedance <Impedance>**

Sets the impedance for the external pulse modulation input.

**Parameters:**

<Impedance>        G50 | G1K

\*RST:            G1K

**Example:**            See [Example "Perform pulse modulation"](#) on page 1051.

**Manual operation:** See ["Impedance Pulse Input"](#) on page 559

**[:SOURce<hw>]:PULM:TRIGger:EXTernal:IMPedance <Impedance>**

Sets the impedance for the external pulse trigger.

**Parameters:**

<Impedance>        G50 | G10K

\*RST:            G50

**Example:**            See [Example "Perform pulse modulation"](#) on page 1051.

## 14.19.5 SOURce:BB subsystem

This subsystem contains all commands for digital signal generation. It is divided into several subsystems which are described separately.

- [SOURce:BB subsystem general commands](#)..... 1057
- [SOURce:BB:DM subsystem](#)..... 1060
- [SOURce:BB:ARbitrary subsystem](#)..... 1092
- [SOURce:BB:MCCW subsystem](#)..... 1149
- [SOURce:BB:IMPairment subsystem](#)..... 1169
- [SOURce:BB:GRAPHics subsystem](#)..... 1174
- [SOURce:BB:MEASurement subsystem](#)..... 1178
- [SOURce:BB:PROGress subsystem](#)..... 1183



### 14.19.5.1 SOURce:BB subsystem general commands

The following section describes the commands for setting the frequency shift and the phase offset for the signal at the output of the "Baseband" and "BB Input" blocks.

#### Suffixes in the keywords ENTity<ch> and SOURce<hw>

You can address multiple entities configurations by using the SCPI commands starting with the keyword SOURce or the alias commands starting with the keyword ENTity.

*Table 14-3: Value ranges of the suffixes ENTity<ch> and SOURce<hw> in advanced configuration with multiple entities*

SCPI Syntax	ENTity<ch>	SOURce<hw>
SOURce<hw>:BB:...	-	1 to 8
ENTity<ch>:SOURce<hw>:BB:...	1 to 8	1 to 4

See also [Section 14.3, "SCPI command aliases for advanced mode with multiple entities"](#), on page 896.

#### Commands:

<a href="#">[:SOURce&lt;hw&gt;]:BBIN:FOFFset</a> .....	1057
<a href="#">[:SOURce&lt;hw&gt;]:BB:FOFFset</a> .....	1057
<a href="#">[:SOURce&lt;hw&gt;]:BBIN:POFFset</a> .....	1058
<a href="#">[:SOURce&lt;hw&gt;]:BB:POFFset</a> .....	1058
<a href="#">[:SOURce&lt;hw&gt;]:BB:PGAin</a> .....	1058
<a href="#">[:SOURce&lt;hw&gt;]:BBIN:PGAin</a> .....	1058
<a href="#">[:SOURce&lt;hw&gt;]:BB:ROUte</a> .....	1059
<a href="#">[:SOURce&lt;hw&gt;]:BBIN:ROUte</a> .....	1059
<a href="#">[:SOURce&lt;hw&gt;]:BB:CODer:MODE</a> .....	1059
<a href="#">[:SOURce&lt;hw&gt;]:BB:POWer:PEAK?</a> .....	1059
<a href="#">[:SOURce&lt;hw&gt;]:BB:CFACTOR?</a> .....	1059
<a href="#">[:SOURce&lt;hw&gt;]:BB:POWer:RMS?</a> .....	1060

---

**[\[:SOURce<hw>\]:BBIN:FOFFset <FOffset>](#)**

**[\[:SOURce<hw>\]:BB:FOFFset <FOffset>](#)**

Sets a frequency offset for the internal or external baseband signal. The offset affects the generated baseband signal.

#### Parameters:

<FOffset>	float
	Range: depends on the installed options
	Increment: 0.01
	*RST: 0
	Default unit: Hz
	E.g. -60 MHz to +60 MHz (R&S SMW-B10)

**Example:** `SOURce1:BB:FOFFset 2MHZ`

**Options:** BBIN:FOFFset requires R&S SMW-B10

**Manual operation:** See ["Frequency Offset"](#) on page 421

---

**[[:SOURCE<hw>]:BBIN:POFFset <POffset>**

Sets the relative phase offset for the external baseband signal.

**Parameters:**

<POffset> float  
 Range: -999.99 to 999.99  
 Increment: 0.01  
 \*RST: 0  
 Default unit: DEG

**Example:** SOURCE1:BBIN:POFFset 0.5

**Manual operation:** See ["Phase Offset"](#) on page 421

---

**[[:SOURCE<hw>]:BB:POFFset <POffset>**

Sets the relative phase offset for the selected baseband signal.

The latter applies for the other paths or the external baseband.

**Parameters:**

<POffset> float  
 Range: 0 to 359.9  
 Increment: 0.01  
 \*RST: 0  
 Default unit: DEG

**Example:** SOURCE1:BB:POFFset 0.5DEG

**Manual operation:** See ["Phase Offset"](#) on page 421

---

**[[:SOURCE<hw>]:BB:PGAin <PGain>**

**[[:SOURCE<hw>]:BBIN:PGAin <PGain>**

Sets the relative gain for the internal or external baseband signal compared with the signals of the other baseband sources.

**Parameters:**

<PGain> float  
 Range: -50 to 50  
 Increment: 1E-3  
 \*RST: 0  
 Default unit: dB

**Example:** BBIN:PGA 3dB

Sets the relative gain of 3 dB for the external baseband signal.

**Manual operation:** See ["Gain"](#) on page 422

---

```
[:SOURce<hw>]:BB:ROUTe <Route>
```

```
[:SOURce<hw>]:BBIN:ROUTe <Route>
```

Selects the signal route for the internal/external baseband signal.

The internal and external signals are summed, if necessary.

**Parameters:**

<Route>                    A | B | AB

**Example:**

```
SOURce1:BBIN:ROUTe A
```

```
// the external baseband signal is added to path A
```

**Options:**                R&S SMW-B10

**Manual operation:**    See "[Signal Routing](#)" on page 151

---

```
[:SOURce<hw>]:BB:CODer:MODE <Mode>
```

Defines the source of the baseband generator.

**Parameters:**

<Mode>                    CODer | BBIN

**CODer**

Internal baseband generator

**BBIN**

An external digital baseband signal provided at the digital interface

\*RST:                    CODer

**Example:**

```
SOURce1:BB:CODer:MODE BBIN
```

---

```
[:SOURce<hw>]:BB:POWER:PEAK?
```

Queries the peak level of the baseband signal relative to full scale of 0.5 V (in terms of dB full scale).

**Return values:**

<Peak>                    float

Range:                  -145 to 30

Increment:              0.01

\*RST:                    0

Default unit: dBfs

**Example:**

```
BB:POW:PEAK
```

Queries the peak level of the baseband signal.

**Usage:**

Query only

---

```
[:SOURce<hw>]:BB:CFACTOR?
```

Queries the crest factor of the baseband signal.

**Return values:**

<CFactor> float  
 Range: 0 to 100  
 Increment: 0.01  
 \*RST: 0  
 Default unit: dB

**Example:**

SOURce1:BB:CFACTOR?  
 Queries the crest factor of the baseband signal.

**Usage:**

Query only

**[:SOURce<hw>]:BB:POWER:RMS?**

Queries the RMS level of the baseband signal relative to full scale of 0.5V (in terms of dB full scale).

**Return values:**

<Rms> float  
 Range: -145 to 30  
 Increment: 0.01  
 \*RST: 0  
 Default unit: dBfs

**Example:**

BB:POWER:RMS?  
 Queries the rms level of the baseband signal.

**Usage:**

Query only

**14.19.5.2 SOURce:BB:DM subsystem**

This section lists the commands of the SOURce:BB:DM subsystem. The commands are divided into sections, where the last one describes how to use lists for digital modulation in remote control, and all other sections describe the configuration of the digital modulation.

**Suffixes in the keywords ENTity<ch> and SOURce<hw>**

You can address multiple entities configurations by using the SCPI commands starting with the keyword SOURce or the alias commands starting with the keyword ENTity.

**Table 14-4: Value ranges of the suffixes ENTity<ch> and SOURce<hw> in advanced configuration with multiple entities**

SCPI Syntax	ENTity<ch>	SOURce<hw>
SOURce<hw>:BB:...	-	1 to 4
ENTity<ch>:SOURce<hw>:BB:...	1 to 4	1 to 4



See also [Section 14.3, "SCPI command aliases for advanced mode with multiple entities"](#), on page 896.

## Required options

See [Section 5.6.1, "Required options"](#), on page 267

The commands are grouped in the following sections:

• <a href="#">Programming examples</a> .....	1061
• <a href="#">General commands</a> .....	1063
• <a href="#">Save/recall commands</a> .....	1067
• <a href="#">Filter commands</a> .....	1069
• <a href="#">Modulation and coding commands</a> .....	1071
• <a href="#">Power ramping</a> .....	1074
• <a href="#">Trigger commands</a> .....	1076
• <a href="#">Marker commands</a> .....	1083
• <a href="#">Clock commands</a> .....	1085
• <a href="#">Handling list files</a> .....	1086

## Programming examples

### Example: Performing general tasks

This example shows how to enable custom digital modulation with predefined settings as basis for further customization (e.g. adjusting the data source); intermediate results and configuration are stored with the save/recall function.

```
// *****
// Reset instrument first
// *****
*RST; *CLS

SOURce1:BB:DM:PRESet
SOURce1:BB:DM:STANdard W3GPp
SOURce1:BB:DM:SRATe?
// 3840000
SOURce1:BB:DM:CODing?
// WCDMA
SOURce1:BB:DM:FORMat?
// QPSK45
SOURce1:BB:DM:STATe ON
SOURce1:BB:DM:SETTing:STORe "/var/user/ digMod/CustDM3GPP"

// *****
// Recall settings
// *****
MME:CDIR "/var/user/digMod"
SOURce1:BB:DM:SETTing:CATalog?
// CusDigMod, cdm3gpp, CustDM3GPP
SOURce1:BB:DM:SETTing:DELeTe "cdm3gpp"
SOURce1:BB:DM:SETTing:LOAD "CusDigMod"

// *****
// Change the data source
// *****
```

```

SOURce1:BB:DM:SOURce?
// PRBS
SOURce1:BB:DM:PRBS:LENGth?
// 9
SOURce1:BB:DM:SOURce DLISt
// Set the default directory and query the existing data lists
MMEM:CDIR "/var/user/DLists"
SOURce1:BB:DM:DLISt:CATalog?
// "DList1","DList2"
// delete a list and create a new data list
SOURce1:BB:DM:DLISt:DELeTe "DList1"
SOURce1:BB:DM:DLISt:SELeCt "DList2"
// copy the content of an existing data list to the new data list
SOURce1:BB:DM:DLISt:COpy "DList3"
// query the content of the new data list and modify it (append data to it)
FORM ASCI
SOURce1:BB:DM:DLISt:DATA? 2048,1024
// 1,1,0,0,0, ...
SOURce1:BB:DM:DLISt:DATA:APPend 1,1,1,0,0,0,1,1,0,1...
SOURce1:BB:DM:DLISt:SELeCt "DList3"
// query the free memory and number of bits to be utilized
SOURce1:BB:DM:DLISt:FREE?
SOURce1:BB:DM:DLISt:POINts?

```

### Example: Adjusting clock, marker and trigger settings

The following example lists the provided commands

```

// *****
// Clock settings
// *****
SOURce1:BB:DM:CLOCK:SOURce INTernal

// *****
// Configure and enable standard marker signals
// *****
SOURce1:BB:DM:TRIGger:OUTPut2:MODE PULSe
SOURce1:BB:DM:TRIGger:OUTPut2:PULSe:DIVider 5
SOURce1:BB:DM:TRIGger:OUTPut2:PULSe:FREQuency?
SOURce1:BB:DM:TRIGger:OUTPut3:MODE PATtern
SOURce1:BB:DM:TRIGger:OUTPut3:PATtern #HE0F52,20
SOURce1:BB:DM:TRIGger:OUTPut1:MODE RATio
SOURce1:BB:DM:TRIGger:OUTPut1:ONTime 40
SOURce1:BB:DM:TRIGger:OUTPut1:OFFTime 20

SOURce1:BB:DM:TRIGger:OUTPut2:DELAy 16

// *****
// Configure and enable signal generation
// *****
SOURce1:BB:DM:TRIGger:SEQuence SINGLE
SOURce1:BB:DM:TRIGger:SLENGth 200

```

```

// the first 200 samples will be output after the next trigger event
SOURcel:BB:DM:TRIGger:SEQuence ARETrigger
SOURcel:BB:DM:TRIGger:SOURce EGT1
// external trigger signal must be provided at the connector
// configured for the external global trigger 1 signal
SOURcel:BB:DM:TRIGger:EXTErnal:SYNChronize:OUTPut ON
SOURcel:BB:DM:TRIGger:EXTErnal:DELAy 200
SOURcel:BB:DM:TRIGger:EXTErnal:INHibit 100

// with internal trigger source
SOURcel:BB:DM:TRIGger:SEQuence AAUTO
SOURcel:BB:DM:TRIGger:SOURce INTernal
SOURcel:BB:DM:STAT ON
SOURcel:BB:DM:TRIGger:EXEC

// SOURcel:BB:DM:TRIGger:SOURce INTB
// the internal trigger signal from the other path must be used
// SOURcel:BB:DM:TRIGger:OBASeband:DELAy 25
// SOURcel:BB:DM:TRIGger:OBASeband:INHibit 10

```

### Example: Enable power ramping

The following example lists the provided commands

```

SOURcel:BB:DM:PRAMP:SOURce INTernal
SOURcel:BB:DM:PRAMP:SHAP COS
SOURcel:BB:DM:PRAMP:TIME 5
SOURcel:BB:DM:PRAMP:RDELAy 0
SOURcel:BB:DM:PRAMP:FDELAy -1
SOURcel:BB:DM:PRAMP:ATTenuation 10
SOURcel:BB:DM:PRAMP:BBONLY:STATe ON
SOURcel:BB:DM:PRAMP:STATe ON

```

### General commands

<a href="#">[:SOURce&lt;hw&gt;]:BB:DM:STATe</a> .....	1063
<a href="#">[:SOURce&lt;hw&gt;]:BB:DM:PRESet</a> .....	1064
<a href="#">[:SOURce&lt;hw&gt;]:BB:DM:SRATe</a> .....	1064
<a href="#">[:SOURce&lt;hw&gt;]:BB:DM:STANdard</a> .....	1064
<a href="#">[:SOURce&lt;hw&gt;]:BB:DM:SOURce</a> .....	1065
<a href="#">[:SOURce&lt;hw&gt;]:BB:DM:PATTern</a> .....	1065
<a href="#">[:SOURce&lt;hw&gt;]:BB:DM:PRBS[:LENGth]</a> .....	1065
<a href="#">[:SOURce&lt;hw&gt;]:BB:DM:SMODulation:BORDer</a> .....	1066
<a href="#">[:SOURce&lt;hw&gt;]:BB:DM:SMODulation:CDTDeviation</a> .....	1066
<a href="#">[:SOURce&lt;hw&gt;]:BB:DM:SMODulation:CLOCK:SLOPe:BIT</a> .....	1066
<a href="#">[:SOURce&lt;hw&gt;]:BB:DM:SMODulation:THRoughput:DELAy?</a> .....	1067
<a href="#">[:SOURce&lt;hw&gt;]:BB:DM:SMODulation:RCVState?</a> .....	1067

---

#### **[\[:SOURce<hw>\]:BB:DM:STATe <State>](#)**

Enables/disables digital modulation. Switching on digital modulation turns off all the other digital standards in the same signal path.

**Parameters:**

<State> 1 | ON | 0 | OFF  
 \*RST: 0

**Example:** See [Example "Performing general tasks"](#) on page 1061

**Manual operation:** See ["State"](#) on page 268

**[[:SOURce<hw>]:BB:DM:PRESet**

Sets the default settings for digital modulation (\*RST values specified for the commands).

Not affected is the state set with the command `SOURce<hw>:BB:DM:STaTe`

**Example:** See [Example "Performing general tasks"](#) on page 1061

**Usage:** Event

**Manual operation:** See ["Set To Default"](#) on page 268

**[[:SOURce<hw>]:BB:DM:SRaTe <SRate>**

Sets the symbol rate in Hz/kHz/MHz or sym/s, ksym/s and Msym/s.

**Parameters:**

<SRate> float  
 Range: 50 to depends on the installed options  
 Increment: 1E-3  
 \*RST: 270833.333  
 Default unit: Hz or sym/s

**Example:** See [Example "Performing general tasks"](#) on page 1061

**Manual operation:** See ["Symbol Rate"](#) on page 269

**[[:SOURce<hw>]:BB:DM:STANdard <Standard>**

Selects predefined set of settings according to the selected standard, see [Table 5-12](#).

**Parameters:**

<Standard> USER | BLUetooth | DECT | ETC | GSM | GSMEdge | NADC | PDC | PHS | TETRa | W3GPp | TDSCdma | CFORward | CREVerse | WORLdspace | TFTS | APCOPH1C4fm | APCOPH1CQpsk | APCOPH2HCpm | APCOPH2HDQpsk | APCOPH2HD8PSKW | APCOPH2HD8PSKN | APCOPH1Lsm | APCOPH1Wcqpsk | CWBPsK | SOQPSKTG  
 A query returns the value `USER` if settings deviate from standard-compliant settings.  
 \*RST: GSM

**Example:** See [Example "Performing general tasks"](#) on page 1061.



**Options:** GSM requires R&S SMW-B10.

**Manual operation:** See ["Set according to Standard"](#) on page 269

**[:SOURce<hw>]:BB:DM:SOURce <Source>**

Selects the data source.

**Parameters:**

<Source> ZERO | ONE | PRBS | PATtern | DLISt | SERial  
 A sequence of 0 or 1, a pseudo-random sequence with different length, a pattern, a data list, or external serial data.  
 \*RST: PRBS

**Example:** See [Example "Performing general tasks"](#) on page 1061

**Manual operation:** See ["Data Source"](#) on page 271

**[:SOURce<hw>]:BB:DM:PATtern <Pattern>, <BitCount>**

Selects the data pattern for the internal data source.

**Parameters:**

<Pattern> numeric  
 \*RST: #H0  
 <BitCount> integer  
 Range: 1 to 64  
 \*RST: 1

**Example:**  
 SOURce:BB:DM:SOURce PATT  
 SOURce:BB:DM:PATtern #B01110111010101010,17  
 Generates the user-defined sequence of 0/1 data.

**Manual operation:** See ["Data Source"](#) on page 271

**[:SOURce<hw>]:BB:DM:PRBS[:LENGTH] <Length>**

Defines the length of the pseudo-random sequence in accordance with the following equation:

$$\text{Length} = (2^{\text{Length}}) - 1$$

**Parameters:**

<Length> 9 | 11 | 15 | 16 | 20 | 21 | 23 | PN9 | PN11 | PN15 | PN16 | PN20 |  
 PN21 | PN23  
 \*RST: 9

**Example:** See [Example "Performing general tasks"](#) on page 1061

**Manual operation:** See ["Data Source"](#) on page 271

---

**[ :SOURce<hw>]:BB:DM:SMODulation:BORDER <BitOrder>**

Sets the bit order for processing extern serial data.

**Parameters:**

<BitOrder>           LSBit | MSBit  
 \*RST:                LSBit

**Example:**

```
SOURce1:INPut:TM1:DIRection INP
SOURce1:INPut:TM1:SIGnAl CLOCK
SOURce1:INPut:TM2:DIRection INP
SOURce1:INPut:TM2:SIGnAl DATA

SOURce1:BB:DM:SOURce SERIAL
SOURce1:BB:DM:SMODulation:BORDER LSBit
SOURce1:BB:DM:SMODulation:CDTDeviation?
SOURce1:BB:DM:SMODulation:CLOCK:SLOPe:BIT POSitive
SOURce1:BB:DM:SMODulation:THROUGHput:DELay?
SOURce1:BB:DM:SMODulation:RCVState?
// Response: OPERational
```

**Manual operation:** See "[Bit Order](#)" on page 274

---

**[ :SOURce<hw>]:BB:DM:SMODulation:CDTDeviation <Deviation>**

Queries the timing deviations (time offset) between the clock and the data signals.

**Parameters:**

<Deviation>           float  
 Range:               -5E-3 to 5E-3  
 Increment:           1E-12  
 \*RST:                0

**Example:**

See [\[:SOURce<hw>\]:BB:DM:SMODulation:BORDER](#) on page 1066.

**Manual operation:** See "[Clock to Data Time Deviation](#)" on page 274

---

**[ :SOURce<hw>]:BB:DM:SMODulation:CLOCK:SLOPe:BIT <Slope>**

Sets the active edge of the bit clock.

**Parameters:**

<Slope>               NEGative | POSitive  
 \*RST:                POSitive

**Example:**

See [\[:SOURce<hw>\]:BB:DM:SMODulation:BORDER](#) on page 1066

**Options:**           R&S SMW-B10

**Manual operation:** See "[Bit Clock Slope](#)" on page 274

**[ :SOURce<hw>]:BB:DM:SMODulation:THRoughput:DELay?**

Queries the throughput delay from the data input to the RF output in the case of external modulation.

**Return values:**

<Delay> integer  
 Range: -100 to 100  
 Increment: 250E-12  
 \*RST: 0

**Example:** See [ :SOURce<hw>]:BB:DM:SMODulation:BORDer on page 1066.

**Usage:** Query only

**Manual operation:** See "Throughput Delay" on page 274

**[ :SOURce<hw>]:BB:DM:SMODulation:RCVState? <RcvState>**

Queries the current state of the receiver of the external data.

**Parameters:**

<RcvState> OFF | OPERational | UFLow | OFLow  
 \*RST: OFF

**Example:** See [ :SOURce<hw>]:BB:DM:SMODulation:BORDer on page 1066.

**Usage:** Query only

**Manual operation:** See "Receiver State" on page 273

**Save/recall commands**

[ :SOURce<hw>]:BB:DM:STANdard:ULISt:CATalog?	1067
[ :SOURce<hw>]:BB:DM:SETTing:CATalog?	1067
[ :SOURce<hw>]:BB:DM:STANdard:ULISt:STORe	1068
[ :SOURce<hw>]:BB:DM:SETTing:STORe	1068
[ :SOURce<hw>]:BB:DM:STANdard:ULISt:LOAD	1068
[ :SOURce<hw>]:BB:DM:SETTing:LOAD	1068
[ :SOURce<hw>]:BB:DM:STANdard:ULISt:DELEte	1068
[ :SOURce<hw>]:BB:DM:SETTing:DELEte	1068

**[ :SOURce<hw>]:BB:DM:STANdard:ULISt:CATalog?****[ :SOURce<hw>]:BB:DM:SETTing:CATalog?**

Queries the files with digital modulation respectively user standard settings in the default directory. Listed are files with the file extension \*.dm and \*.dm\_stu.

Refer to [Section 14.7.2, "Handling files in the default or in a specified directory"](#), on page 906 for general information on file handling in the default and a specific directory.

**Return values:**

<Catalog> "<filename1>,<filename2>,..."  
Returns a string of file names separated by commas.

**Example:** See [Example "Performing general tasks"](#) on page 1061

**Usage:** Query only

**Manual operation:** See ["Save/Recall"](#) on page 269

**[:SOURce<hw>]:BB:DM:STANdard:ULIST:STORE <Filename>**

**[:SOURce<hw>]:BB:DM:SETTing:STORE <Filename>**

Stores the current settings into the selected file; the file extension (\*.dm respectively \*.dm\_stu) is assigned automatically.

Refer to [Section 14.7.2, "Handling files in the default or in a specified directory"](#), on page 906 for general information on file handling in the default and a specific directory.

**Setting parameters:**

<Filename> string

**Example:** See [Example "Performing general tasks"](#) on page 1061

**Usage:** Setting only

**Manual operation:** See ["Save/Recall"](#) on page 269

**[:SOURce<hw>]:BB:DM:STANdard:ULIST:LOAD <Filename>**

**[:SOURce<hw>]:BB:DM:SETTing:LOAD <Filename>**

Loads the selected file from the default or the specified directory. Loaded are files with extension \*.dm respectively \*.dm\_stu.

Refer to [Section 14.7.2, "Handling files in the default or in a specified directory"](#), on page 906 for general information on file handling in the default and a specific directory.

**Setting parameters:**

<Filename> string

**Example:** See [Example "Performing general tasks"](#) on page 1061

**Usage:** Setting only

**Manual operation:** See ["Save/Recall"](#) on page 269

**[:SOURce<hw>]:BB:DM:STANdard:ULIST:DELeTe <Filename>**

**[:SOURce<hw>]:BB:DM:SETTing:DELeTe <Filename>**

Deletes the selected file from the default or specified directory. Deleted are files with the file extension \*.dm respectively \*.dm\_stu.

Refer to [Section 14.7.2, "Handling files in the default or in a specified directory"](#), on page 906 for general information on file handling in the default and a specific directory.

**Setting parameters:**

<Filename> string

**Example:** See [Example "Performing general tasks"](#) on page 1061

**Usage:** Setting only

**Manual operation:** See ["Save/Recall"](#) on page 269

**Filter commands**

---

**[ :SOURce<hw>]:BB:DM:FILTER:TYPE <Type>**

Selects the filter type.

If you select a standard (:BB:DM:STAN), the firmware automatically sets the standard-compliant filter type and filter parameter.

**Parameters:**

<Type> RCOSine | COSine | GAUSSs | LGAuss | CONE | COF705 |  
 COEQUALizer | COFEQUALizer | C2K3x | APCO25 | SPHase |  
 RECTangle | USER | PGAuss | LPASs | DIRac | ENPShape |  
 EWPSshape | LTEFilter | LPASSEVM | APCO25Hcpm |  
 APCO25Lsm | HRP | SOQPSK  
 \*RST: GAUSSs

**Example:** See [\[:SOURce<hw>\]:BB:DM:FILTER:PARAMeter:SPHase](#) on page 1069.

**Manual operation:** See ["Filter"](#) on page 279

---

**[ :SOURce<hw>]:BB:DM:FILTER:PARAMeter:APCO25 <Apco25>**  
**[ :SOURce<hw>]:BB:DM:FILTER:PARAMeter:APCO25Lsm:GAUSSs <Gauss>**  
**[ :SOURce<hw>]:BB:DM:FILTER:PARAMeter:APCO25Lsm:LOWPass <FiltParm>**  
**[ :SOURce<hw>]:BB:DM:FILTER:PARAMeter:COSine:BANDwidth <Bandwidth>**  
**[ :SOURce<hw>]:BB:DM:FILTER:PARAMeter:COSine[:ROLLoff] <Cosine>**  
**[ :SOURce<hw>]:BB:DM:FILTER:PARAMeter:GAUSSs <Gauss>**  
**[ :SOURce<hw>]:BB:DM:FILTER:PARAMeter:LPASs <LPass>**  
**[ :SOURce<hw>]:BB:DM:FILTER:PARAMeter:LPASSEVM <LPassEvm>**  
**[ :SOURce<hw>]:BB:DM:FILTER:PARAMeter:PGAuss <PGauss>**  
**[ :SOURce<hw>]:BB:DM:FILTER:PARAMeter:RCOSine <RCosine>**  
**[ :SOURce<hw>]:BB:DM:FILTER:PARAMeter:SPHase <SPHase>**

Sets the filter parameter.

Filter Type	Parameter	Parameter Name	Min	Max	Increment	Default
APCO25	Roll-off factor	<Apco25>	0.05	0.99	0.01	0.2
APCO25Lsm	Cut off frequency for the lowpass/gauss filter (:LOWPass/:GAUSSs)	<Cosine>	400	25E6	1E-3	270833.333
COSine	Bandwidth	<FiltParm>	400	depends on the installed options <sup>*)</sup>	1E-3	270833.333
COSine	Roll-off factor	<Cosine>	0.05	1	0.01	0.35
GAUSSs	Roll-off factor	<Gauss>	0.15	100000	0.01	0.3
LPASSs	Cut-off frequency	<LPass>	0.05	2	0.01	0.5
LPASSEVM	Cut-off frequency	<LPassEvm>	0.05	2	0.01	0.5
PGAUSSs	Roll-off factor	<PGAUSSs>	0.15	2.5	0.01	0.3
RCOSine	Roll-off factor	<RCosine>	0.05	1	0.001	0.35
SPHase	B x T	<SPHase>	0.15	2.5	0.01	2

<sup>\*)</sup>100E6 (R&S SMW-B10) / 600E6 (R&S SMW-B9)

**Parameters:**

<SPHase> float  
 Range: 0.15 to 2.5  
 Increment: 0.01  
 \*RST: 2

**Example:** SOURce:BB:DM:FILTer:TYPE SPHase  
 SOURce:BB:DM:FILTer:PARAMeter:SPHase 0.5

**Manual operation:** See "Roll Off Factor/B\*T" on page 279

---

**[ :SOURce<hw>]:DM:FILTer:PARAMeter <Parameter>**

Sets the filter parameter of the currently selected filter type.

To set the filter type, use command [ :SOURce<hw>]:BB:DM:FILTer:TYPE on page 1069.

**Parameters:**

<Parameter> float  
 Range: 0.05 to 2.5  
 Increment: 0.01  
 \*RST: 0.35

**Example:** See [ :SOURce<hw>]:BB:DM:FILTer:PARAMeter:SPHase on page 1069

### Modulation and coding commands

---

**[ :SOURce<hw>]:BB:DM:CODing <Coding>**

Selects the modulation coding.

**Parameters:**

<Coding> OFF | DIFF | DPHS | DGRay | GRAY | GSM | NADC | PDC | PHS | TETRa | APCO25 | PWT | TFTS | INMarsat | VDL | EDGE | APCO25FSK | ICO | CDMA2000 | WCDMA | APCO258PSK

**OFF**

The coding is automatically disabled if the selected modulation type is not possible with the coding that has been set

**DPHS**

Phase Difference

**DGRay**

Difference + Gray

\*RST: GSM

**Example:** See [Example "Performing general tasks"](#) on page 1061

**Options:** DPHS|GSM|INMarsat require R&S SMW-B10

**Manual operation:** See ["Coding"](#) on page 270

---

**[ :SOURce<hw>]:BB:DM:FORMat <Format>**

Sets the modulation type.

When a standard is selected ( `[ :SOURce<hw>]:BB:DM:STANdard` ), the modulation type is set to the default value.

**Parameters:**

<Format> ASK | BPSK | P2DBpsk | QPSK | QPSK45 | OQPSk | P4QPsk | P4DQpsk | PSK8 | P8D8psk | P8EDge | QAM16 | QAM32 | QAM64 | QAM256 | QAM1024 | MSK | FSK2 | FSK4 | USER | FSKVar | QAM128 | QEDGe | QAM16EDge | QAM32EDge | AQPSk | QAM4096 | APSK16 | APSK32 | FSK32 | FSK64 | FSK8 | FSK16 | QAM512 | QAM2048

\*RST: MSK

**Example:** See [Example "Performing general tasks"](#) on page 1061

**Manual operation:** See ["Modulation Type"](#) on page 276

---

**[ :SOURce<hw>]:BB:DM:AQPSk:ANGLE <Angle>**

For AQPSK modulation, sets the angle alpha between the point (0,0) and the I axis.

**Parameters:**

<Angle> float  
 Range: 0 to 180  
 Increment: 0.01  
 \*RST: 0  
 Default unit: Deg

**Example:**

```
BB:DM:FORM AQPS
BB:DM:AQPS:ANGL 45
```

**Manual operation:** See ["Angle Alpha"](#) on page 277

**[:SOURce<hw>]:BB:DM:ASK:DEPTH <Depth>**

Sets the ASK modulation depth for modulation type ASK.

**Parameters:**

<Depth> float  
 Range: 0 to 100  
 Increment: 0.1  
 \*RST: 100  
 Default unit: PCT

**Example:**

```
BB:DM:FORM ASK
BB:DM:ASK:DEPT 50 PCT
```

**Manual operation:** See ["ASK Depth"](#) on page 277

**[:SOURce<hw>]:BB:DM:FSK:DEVIation <Deviation>**

Sets the frequency deviation when FSK modulation is selected.

**Parameters:**

<Deviation> float  
 The value range depends on the symbol rate.  
 Range: 1 to 40E6  
 Increment: 0.5  
 \*RST: 135416.5

**Example:**

```
SOURce:BB:DM:FORMat FSK4
SOURce:BB:DM:FSK:DEVIation 1MHZ
```

**Manual operation:** See ["FSK Deviation"](#) on page 277

**[:SOURce<hw>]:BB:DM:FSK:VARiable:SYMBOL<ch0>:DEVIation <Deviation>**

Sets the deviation of the selected symbol for variable FSK modulation mode.

The value range depends on the configured symbol rate.

For more information, refer to the specifications document.



**Parameters:**

<Deviation> float

Range: depends on settings  
 Increment: 0.5  
 Default unit: Hz

**Example:**

```
SOURce:BB:DM:FORMat FSKVar
SOURce:BB:DM:FSK:VARIable:TYPE FSK4
SOURce:BB:DM:FSK:VARIable:SYMBol0:DEVIation 135000
```

**Manual operation:** See "[Deviation xxxx](#)" on page 277

**[:SOURce<hw>]:BB:DM:FSK:VARIable:TYPE <Type>**

The command selects the modulation type for Variable FSK.

**Parameters:**

<Type> FSK4 | FSK8 | FSK16  
 \*RST: FSK4

**Example:**

See [\[:SOURce<hw>\]:BB:DM:FSK:VARIable:SYMBol<ch0>:DEVIation](#) on page 1072

**Manual operation:** See "[FSK Type](#)" on page 277

**[:SOURce<hw>]:BB:DM:APSK16:GAMMa <Gamma>**

Sets the gamma function  $\gamma$  for the 16APSK modulation.

**Parameters:**

<Gamma> G2D3 | G3D4 | G4D5 | G5D6 | G8D9 | G9D10  
 GxDy: G = Gamma function, x $\gamma$  = code rate  
 \*RST: G2D3

**Example:**

```
SOURce1:BB:DM:FORMat APSK16
SOURce1:BB:DM:APSK16:GAMMa G9D10
```

**Manual operation:** See "[Gamma/Gamma 1](#)" on page 278

**[:SOURce<hw>]:BB:DM:APSK32:GAMMa <Gamma>**

Sets the gamma function  $\gamma$  for the 32APSK modulation.

**Parameters:**

<Gamma> G3D4 | G4D5 | G5D6 | G8D9 | G9D10  
 GxDy: G = Gamma function, x $\gamma$  = code rate  
 \*RST: G3D4

**Example:**

```
SOURce1:BB:DM:FORMat APSK32
SOURce1:BB:DM:APSK32:GAMMa G9D10
```

**Manual operation:** See "[Gamma/Gamma 1](#)" on page 278

---

**[[:SOURce<hw>]:BB:DM:SWITching:STATe <State>**

Enables switching between a modulated and an unmodulated signal.

**Parameters:**

<State>                    1 | ON | 0 | OFF  
 \*RST:                    0

**Example:**

SCONfiguration:MODE ADV  
 SCONfiguration:APPLY  
 SOURce1:BB:DM:SWITching:STATe ON

**Manual operation:** See ["State Modulation CW Switching"](#) on page 278

**Power ramping**

<a href="#">[:SOURce&lt;hw&gt;]:BB:DM:PRAMp:SOURce</a> .....	1074
<a href="#">[:SOURce&lt;hw&gt;]:BB:DM:PRAMp:SHAPE</a> .....	1074
<a href="#">[:SOURce&lt;hw&gt;]:BB:DM:PRAMp:TIME</a> .....	1075
<a href="#">[:SOURce&lt;hw&gt;]:BB:DM:PRAMp:FDElay</a> .....	1075
<a href="#">[:SOURce&lt;hw&gt;]:BB:DM:PRAMp:RDElay</a> .....	1075
<a href="#">[:SOURce&lt;hw&gt;]:BB:DM:PRAMp:ATTenuation</a> .....	1075
<a href="#">[:SOURce&lt;hw&gt;]:BB:DM:PRAMp:BBONLY[::STATe]</a> .....	1076
<a href="#">[:SOURce&lt;hw&gt;]:BB:DM:PRAMp[::STATe]</a> .....	1076

---

**[[:SOURce<hw>]:BB:DM:PRAMp:SOURce <Source>**

Sets the source for the power ramp control signals.

**Parameters:**

<Source>                    INTernal  
 \*RST:                    INTernal

**Example:** See [Example "Enable power ramping"](#) on page 1063

**Options:** R&S SMW-B10

**Manual operation:** See ["Source"](#) on page 281

---

**[[:SOURce<hw>]:BB:DM:PRAMp:SHAPE <Shape>**

Sets the edge shape of the ramp envelope.

**Parameters:**

<Shape>                    LINear | COSine  
 \*RST:                    COSine

**Example:** See [Example "Enable power ramping"](#) on page 1063

**Options:** R&S SMW-B10

**Manual operation:** See ["Ramp Function"](#) on page 281

---

**[[:SOURce<hw>]:BB:DM:PRAMP:TIME <Time>**

Sets the power ramping rise time and fall time for a burst.

**Parameters:**

<Time> float  
 Range: 0.25 to 16  
 Increment: 0.01  
 \*RST: 1  
 Default unit: symbol

**Example:** See [Example "Enable power ramping"](#) on page 1063

**Options:** R&S SMW-B10

**Manual operation:** See ["Ramp Time"](#) on page 281

---

**[[:SOURce<hw>]:BB:DM:PRAMP:FDElay <FDelay>**

**[[:SOURce<hw>]:BB:DM:PRAMP:RDElay <RDElay>**

Sets the delay in the rising edge.

**Parameters:**

<RDElay> float  
 Range: 0 to 4  
 Increment: 0.01  
 \*RST: 0  
 Default unit: symbol

**Example:** See [Example "Enable power ramping"](#) on page 1063

**Options:** R&S SMW-B10

**Manual operation:** See ["Rise Delay"](#) on page 281

---

**[[:SOURce<hw>]:BB:DM:PRAMP:ATTenuation <Attenuation>**

Sets the level attenuation for signal ranges that are flagged with level attribute *attenuated* by the control signal.

**Parameters:**

<Attenuation> float  
 Range: 0 to 50  
 Increment: 0.1  
 \*RST: 15  
 Default unit: dB

**Example:** See [Example "Enable power ramping"](#) on page 1063

**Options:** R&S SMW-B10

**Manual operation:** See ["Attenuation"](#) on page 282

---

**[[:SOURce<hw>]:BB:DM:PRAMP:BBONLY[:STATe] <State>**

Enables power ramping in the baseband only or mixed power ramping in the baseband and the RF section.

The ON setting is mandatory if, with power ramping active, only the baseband signal is output (I/Q outputs).

In case of two-path instruments, the ON setting is also mandatory if a baseband signal is applied to both paths.

Only then can a signal with a defined, predictable level be output.

**Parameters:**

<State>                    1 | ON | 0 | OFF  
 \*RST:                    0

**Example:**                See [Example "Enable power ramping"](#) on page 1063.

**Options:**                 R&S SMW-B10

**Manual operation:**    See ["In Baseband Only"](#) on page 282

---

**[[:SOURce<hw>]:BB:DM:PRAMP[:STATe] <State>**

Enables or disables power ramping.

**Parameters:**

<State>                    1 | ON | 0 | OFF  
 \*RST:                    0

**Example:**                See [Example "Enable power ramping"](#) on page 1063

**Options:**                 R&S SMW-B10

**Manual operation:**    See ["State"](#) on page 281

**Trigger commands**

<a href="#">[:SOURce&lt;hw&gt;]:BB:DM[:TRIGger]:SEQuence</a> .....	1077
<a href="#">[:SOURce&lt;hw&gt;]:BB:DM:TRIGger:SOURce</a> .....	1077
<a href="#">[:SOURce&lt;hw&gt;]:BB:DM:TRIGger:SLENgth</a> .....	1078
<a href="#">[:SOURce&lt;hw&gt;]:BB:DM:TRIGger:RMODE?</a> .....	1078
<a href="#">[:SOURce&lt;hw&gt;]:BB:DM:TRIGger:TIME:DATE</a> .....	1078
<a href="#">[:SOURce&lt;hw&gt;]:BB:DM:TRIGger:TIME:TIME</a> .....	1079
<a href="#">[:SOURce&lt;hw&gt;]:BB:DM:TRIGger:TIME[:STATe]</a> .....	1079
<a href="#">[:SOURce&lt;hw&gt;]:BB:DM:TRIGger:EXTErnal:SYNChronize:OUTPut</a> .....	1080
<a href="#">[:SOURce&lt;hw&gt;]:BB:DM:TRIGger:ARM:EXECute</a> .....	1080
<a href="#">[:SOURce&lt;hw&gt;]:BB:DM:TRIGger:EXECute</a> .....	1080
<a href="#">[:SOURce&lt;hw&gt;]:BB:DM:TRIGger:OBASeband:DELAy</a> .....	1080
<a href="#">[:SOURce&lt;hw&gt;]:BB:DM:TRIGger:OBASeband:RDELAy?</a> .....	1081
<a href="#">[:SOURce&lt;hw&gt;]:BB:DM:TRIGger:OBASeband:TDELAy</a> .....	1081
<a href="#">[:SOURce&lt;hw&gt;]:BB:DM:TRIGger:OBASeband:INHibit</a> .....	1081
<a href="#">[:SOURce&lt;hw&gt;]:BB:DM:TRIGger:DELAy:UNIT</a> .....	1081

<code>[:SOURce&lt;hw&gt;]:BB:DM:TRIGger[:EXternal]:DELay</code> .....	1082
<code>[:SOURce&lt;hw&gt;]:BB:DM:TRIGger[:EXternal]:TDELay</code> .....	1082
<code>[:SOURce&lt;hw&gt;]:BB:DM:TRIGger[:EXternal]:RDELay?</code> .....	1083
<code>[:SOURce&lt;hw&gt;]:BB:DM:TRIGger[:EXternal]:INHibit</code> .....	1083

---

### `[:SOURce<hw>]:BB:DM[:TRIGger]:SEQUence` <Sequence>

Selects the trigger mode.

See also ["About trigger modes"](#) on page 237.

#### Parameters:

<Sequence>            AUTO | RETRigger | AAUTo | ARETrigger | SINGLE  
 \*RST:                AUTO

**Example:**            See [Example "Adjusting clock, marker and trigger settings"](#)  
 on page 1062

**Manual operation:**    See ["Mode"](#) on page 253

---

### `[:SOURce<hw>]:BB:DM:TRIGger:SOURce` <Source>

Selects the trigger signal source and determines the way the triggering is executed. Provided are the following trigger sources:

- INTernal: Internal manual triggering of the instrument
- INTA | INTB: Internal triggering by a signal from the other basebands
- External trigger signal via one of the local or global connectors:
  - EGT1 | EGT2: External global trigger
  - EGC1 | EGC2: External global clock
  - ELTRigger: External local trigger
  - ELCLock: External local clock
- For secondary instruments (SCONfiguration:MULTIinstrument:MODE SEC), triggering via the external baseband synchronization signal of the primary instrument:  
`SOURcel:BB:ARB:TRIGger:SOURce BBSY`
- OBASeband | BEXternal | EXternal: Setting only  
 Provided only for backward compatibility with other Rohde & Schwarz signal generators. The R&S SMW200A accepts these values and maps them automatically as follows:  
`EXternal = EGT1, BEXternal = EGT2, OBASeband = INTA or INTB`  
 (depending on the current baseband)

#### Parameters:

<Source>                INTB|INTernal|OBASeband|EGT1|EGT2|EGC1|EGC2|ELTRigger|INTA|ELCLock|BEXternal|EXternal | BBSY  
 \*RST:                INTernal

**Example:**            See [Example "Adjusting clock, marker and trigger settings"](#)  
 on page 1062

**Options:** ELTRigger|ELCLock require R&S SMW-B10  
BBSY require R&S SMW-B9

**Manual operation:** See ["Source"](#) on page 255

**[:SOURce<hw>]:BB:DM:TRIGger:SLENgth <SLength>**

Defines the length of the signal sequence to be output in the SINGLe trigger mode.

**Parameters:**

<SLength> integer  
Range: 1 to 4294967295  
\*RST: 1000  
Default unit: symbol

**Example:** See [Example "Adjusting clock, marker and trigger settings"](#) on page 1062

**Manual operation:** See ["Signal Duration"](#) on page 257

**[:SOURce<hw>]:BB:DM:TRIGger:RMODe?**

Queries the status of signal generation.

**Return values:**

<RMode> STOP | RUN

**Example:** SOURce1:BB:DM:TRIGger:SOURce ELTRigger  
SOURce1:BB:DM:TRIGger:SEQuence ARETrigger  
SOURce1:BB:DM:TRIGger:RMODe?  
Response: RUN

**Usage:** Query only

**Manual operation:** See ["Running/Stopped"](#) on page 254

**[:SOURce<hw>]:BB:DM:TRIGger:TIME:DATE <Year>, <Month>, <Day>**

Sets the date for a time-based trigger signal. For trigger modes single or armed auto, you can activate triggering at this date via the following command:

SOURce<hw>:BB:<DigStd>:TRIGger:TIME:STATE

<DigStd> is the mnemonic for the digital standard, for example, ARB. Time-based triggering behaves analogously for all digital standards that support this feature.

**Parameters:**

<Year> integer  
Range: 1980 to 9999  
  
<Month> integer  
Range: 1 to 12

<Day> integer  
Range: 1 to 31

**Example:** See [Example "Configure a time-based trigger signal"](#) on page 1137.

**Manual operation:** See ["Trigger Time"](#) on page 254

**[SOURce<hw>]:BB:DM:TRIGger:TIME:TIME** <Hour>, <Minute>, <Second>

Sets the time for a time-based trigger signal. For trigger modes single or armed auto, you can activate triggering at this time via the following command:

```
SOURce<hw>:BB:<DigStd>:TRIGger:TIME:STATe
```

<DigStd> is the mnemonic for the digital standard, for example, ARB. Time-based triggering behaves analogously for all digital standards that support this feature.

**Parameters:**

<Hour> integer  
Range: 0 to 23

<Minute> integer  
Range: 0 to 59

<Second> integer  
Range: 0 to 59

**Example:** See [Example "Configure a time-based trigger signal"](#) on page 1137.

**Manual operation:** See ["Trigger Time"](#) on page 254

**[SOURce<hw>]:BB:DM:TRIGger:TIME[:STATe]** <TimeTrigState>

Activates time-based triggering with a fixed time reference. If activated, the R&S SMW200A triggers signal generation when its operating system time matches a specified time.

Specify the trigger date and trigger time with the following commands:

```
SOURce<hw>:BB:<DigStd>:TRIGger:TIME:DATE
```

```
SOURce<hw>:BB:<DigStd>:TRIGger:TIME:TIME
```

<DigStd> is the mnemonic for the digital standard, for example, ARB. Time-based triggering behaves analogously for all digital standards that support this feature.

**Parameters:**

<TimeTrigState> 1 | ON | 0 | OFF  
\*RST: 0

**Example:** See [Example "Configure a time-based trigger signal"](#) on page 1137.

**Manual operation:** See ["Time Based Trigger"](#) on page 254

---

**[:SOURce<hw>]:BB:DM:TRIGger:EXTernal:SYNChronize:OUTPut <Output>**

Enables signal output synchronous to the trigger event.

**Parameters:**

<Output>            1 | ON | 0 | OFF  
 \*RST:                1

**Example:**            See [Example "Adjusting clock, marker and trigger settings"](#) on page 1062

**Manual operation:** See "[Sync. Output to Ext. Trigger/Sync. Output to Trigger](#)" on page 256

---

**[:SOURce<hw>]:BB:DM:TRIGger:ARM:EXECute**

Stops signal generation; a subsequent internal or external trigger event restart signal generation.

**Example:**            See also [Example "Adjusting clock, marker and trigger settings"](#) on page 1062

**Usage:**                Event

**Manual operation:** See "[Arm](#)" on page 255

---

**[:SOURce<hw>]:BB:DM:TRIGger:EXECute**

Executes a trigger.

**Example:**            See [Example "Adjusting clock, marker and trigger settings"](#) on page 1062

**Usage:**                Event

**Manual operation:** See "[Execute Trigger](#)" on page 255

---

**[:SOURce<hw>]:BB:DM:TRIGger:OBASeband:DELay <Delay>**

Specifies the trigger delay (expressed as a number of symbols) for triggering by the trigger signal from the other path.

**Parameters:**

<Delay>                float  
 Range:                0 to 2147483647  
 Increment:            0.01  
 \*RST:                 0

**Example:**            See [Example "Adjusting clock, marker and trigger settings"](#) on page 1062

**Manual operation:** See "[\(Specified\) External Delay/\(Specified\) Trigger Delay](#)" on page 257



**[[:SOURce<hw>]:BB:DM:TRIGger:OBASeband:RDElay?**

Queries the time a trigger event from the other path is delayed.

**Return values:**

<ObResTimeDelSec> float

Range: 0 to 688

Increment: 0.25E-9

\*RST: 0

**Example:** See [Example "To specify delay and inhibit values in time units"](#) on page 1136.

**Usage:** Query only

**Manual operation:** See ["Actual Trigger Delay/Actual External Delay"](#) on page 257

**[[:SOURce<hw>]:BB:DM:TRIGger:OBASeband:TDElay <ObasTimeDelay>**

Sets the trigger delay for triggering by the signal from the other path.

**Parameters:**

<ObasTimeDelay> float

Range: 0 to 7929.170398682

Increment: 250E-12

\*RST: 0

Default unit: s

**Example:** See [Example "To specify delay and inhibit values in time units"](#) on page 1136.

**Manual operation:** See ["\(Specified\) External Delay/\(Specified\) Trigger Delay"](#) on page 257

**[[:SOURce<hw>]:BB:DM:TRIGger:OBASeband:INHibit <Inhibit>**

Specifies the number of symbols by which a restart is inhibited. This command applies only for triggering by the second path.

**Parameters:**

<Inhibit> integer

Range: 0 to 67108863

\*RST: 0

Default unit: symbol

**Example:** See [Example "Adjusting clock, marker and trigger settings"](#) on page 1062

**Manual operation:** See ["External Inhibit/Trigger Inhibit"](#) on page 256

**[[:SOURce<hw>]:BB:DM:TRIGger:DElay:UNIT <TrigDelUnit>**

Sets the unit of the trigger delay.

**Parameters:**

<TrigDelUnit>      SAMPLE | TIME  
 \*RST:              SAMPlE

**Example:**            See [Example "To specify delay and inhibit values in time units"](#) on page 1136.

**Manual operation:** See "[\(External\) Delay Unit](#)" on page 256

**[:SOURce<hw>]:BB:DM:TRIGger[:EXTernal]:DELay <Delay>**

Sets the trigger delay in symbols.

Maximum trigger delay and trigger inhibit values depend on the installed options. See "[To set delay and inhibit values](#)" on page 242.

**Parameters:**

<Delay>              float  
 Range:              0 to depends on the symbol rate  
 Increment:        0.01  
 \*RST:                0  
 Default unit:      symbol  
 E.g. 0 to 2147483647 symbols (R&S SMW-B10)

**Example:**            See [Example "Adjusting clock, marker and trigger settings"](#) on page 1062.

**Manual operation:** See "[\(Specified\) External Delay/\(Specified\) Trigger Delay](#)" on page 257

**[:SOURce<hw>]:BB:DM:TRIGger[:EXTernal]:TDELay <ExtTimeDelay>**

Sets the trigger delay for external triggering. The value affects all external trigger signals.

Maximum trigger delay and trigger inhibit values depend on the installed options. See "[To set delay and inhibit values](#)" on page 242.

**Parameters:**

<ExtTimeDelay>    float  
 Range:              0 to 7929.170398682  
 Increment:        0.25E-9  
 \*RST:                0  
 Default unit:      s

**Example:**            See [Example "To specify delay and inhibit values in time units"](#) on page 1136.

**Manual operation:** See "[\(Specified\) External Delay/\(Specified\) Trigger Delay](#)" on page 257

**[[:SOURce<hw>]:BB:DM:TRIGger[:EXTernal]:RDELay?**

Queries the time (in seconds) an external trigger event is delayed for.

**Return values:**

<ResTimeDelaySec> float  
 Range: 0 to 688  
 Increment: 0.25E-9  
 \*RST: 0

**Example:** See [Example "To specify delay and inhibit values in time units"](#) on page 1136.

**Usage:** Query only

**Manual operation:** See ["Actual Trigger Delay/Actual External Delay"](#) on page 257

**[[:SOURce<hw>]:BB:DM:TRIGger[:EXTernal]:INHibit <Inhibit>**

Sets the number of symbols that inhibit a restart of the signal generation.

Maximum trigger delay and trigger inhibit values depend on the installed options. See ["To set delay and inhibit values"](#) on page 242.

**Parameters:**

<Inhibit> integer  
 Range: 0 to 21.47 \* (symbol rate)  
 \*RST: 0  
 Default unit: symbol  
 E.g. 0 to 2147483647 symbols (R&S SMW-B10)

**Example:** See [Example "Adjusting clock, marker and trigger settings"](#) on page 1062.

**Manual operation:** See ["External Inhibit/Trigger Inhibit"](#) on page 256

**Marker commands**

[[:SOURce<hw>]:BB:DM:TRIGger:OUTPut<ch>:MODE.....	1083
[[:SOURce<hw>]:BB:DM:TRIGger:OUTPut<ch>:ONTime.....	1084
[[:SOURce<hw>]:BB:DM:TRIGger:OUTPut<ch>:OFFTime.....	1084
[[:SOURce<hw>]:BB:DM:TRIGger:OUTPut<ch>:PATTern.....	1084
[[:SOURce<hw>]:BB:DM:TRIGger:OUTPut<ch>:PULSe:DIVider.....	1085
[[:SOURce<hw>]:BB:DM:TRIGger:OUTPut<ch>:PULSe:FREQUency?.....	1085
[[:SOURce<hw>]:BB:DM:TRIGger:OUTPut<ch>:DELay.....	1085

**[[:SOURce<hw>]:BB:DM:TRIGger:OUTPut<ch>:MODE <Mode>**

Defines the signal for the selected marker output.

For detailed description of the regular marker modes, refer to ["Marker modes"](#) on page 232.

**Parameters:**

<Mode> CLISt | PULSe | PATTeRn | RATIo

**CLISt**

A marker signal that is defined in the selected control list is generated.

\*RST: RATIo

**Example:**

See [Example "Adjusting clock, marker and trigger settings"](#) on page 1062

**Manual operation:** See ["Mode"](#) on page 259

**[[:SOURce<hw>]:BB:DM:TRIGger:OUTPut<ch>:ONTime <OnTime>**

**[[:SOURce<hw>]:BB:DM:TRIGger:OUTPut<ch>:OFFTime <OffTime>**

Sets the number of symbols in a period (ON time + OFF time) for marker RATIo.

\*) If R&S SMW-B9 is installed, the minimum marker duration depends on the sample/symbol rate.

See ["Marker minimum duration"](#) on page 234.

**Parameters:**

<OffTime> integer

Range: 1 (R&S SMW-B10) / 1\* (R&S SMW-B9) to 16777215

\*RST: 1

Default unit: symbol

**Example:**

See [Example "Adjusting clock, marker and trigger settings"](#) on page 1062

**Manual operation:** See ["Mode"](#) on page 259

**[[:SOURce<hw>]:BB:DM:TRIGger:OUTPut<ch>:PATTeRn <Pattern>, <BitCount>**

Defines the bit pattern used to generate the marker signal.

**Parameters:**

<Pattern> numeric

\*RST: #H2

<BitCount> integer

0 = marker off, 1 = marker on

Range: 1 to 64

\*RST: 2

**Example:**

See [Example "Adjusting clock, marker and trigger settings"](#) on page 1062.

**Manual operation:** See ["Mode"](#) on page 259

---

**[:SOURce<hw>]:BB:DM:TRIGger:OUTPut<ch>:PULSe:DIVider <Divider>**

Sets the divider for pulse marker mode (PULSe).

\*) If R&S SMW-B9 is installed, the minimum marker duration depends on the sample/symbol rate.

See ["Marker minimum duration"](#) on page 234.

**Parameters:**

<Divider> integer  
 Range: 2 (R&S SMW-B10) / 2\* (R&S SMW-B9) to 1024  
 \*RST: 2

**Example:** See [Example "Adjusting clock, marker and trigger settings"](#) on page 1062

**Manual operation:** See ["Mode"](#) on page 259

---

**[:SOURce<hw>]:BB:DM:TRIGger:OUTPut<ch>:PULSe:FREQuency?**

Queries the pulse frequency of the pulsed marker signal PULSe.

**Return values:**

<Frequency> float

**Example:** See [Example "Adjusting clock, marker and trigger settings"](#) on page 1062

**Usage:** Query only

**Manual operation:** See ["Mode"](#) on page 259

---

**[:SOURce<hw>]:BB:DM:TRIGger:OUTPut<ch>:DELay <Delay>**

Defines the delay between the signal on the marker outputs and the start of the signal, expressed in terms of symbols.

**Parameters:**

<Delay> float  
 Range: 0 to 16777215  
 Increment: 0.001  
 \*RST: 0

**Example:** See [Example "Adjusting clock, marker and trigger settings"](#) on page 1062.

**Manual operation:** See ["Delay"](#) on page 259

**Clock commands**

[\[:SOURce<hw>\]:BB:DM:CLOCK:MODE](#).....1086  
[\[:SOURce<hw>\]:BB:DM:CLOCK:SOURce](#)..... 1086

---

**[:SOURce<hw>]:BB:DM:CLOCK:MODE <Mode>**

Sets the type of externally supplied clock.

**Parameters:**

<Mode>                   SYMBOL  
                           \*RST:       SYMBOL

**Example:**             See [Example "Adjusting clock, marker and trigger settings"](#) on page 1062.

**Options:**             R&S SMW-B10

**Manual operation:** See ["Clock Mode"](#) on page 260

---

**[:SOURce<hw>]:BB:DM:CLOCK:SOURce <Source>**

Selects the clock source:

- INTernal: Internal clock reference
- ELCLock: External local clock
- EXTernal = ELCLock: Setting only  
     Provided for backward compatibility with other Rohde & Schwarz signal generators

**Parameters:**

<Source>                INTernal|ELCLock|EXTernal  
                           \*RST:       INTernal

**Example:**             See [Example "Adjusting clock, marker and trigger settings"](#) on page 1062.

**Options:**             ELCLock requires R&S SMW-B10

**Manual operation:** See ["Clock Source"](#) on page 260

### Handling list files

---

**[:SOURce<hw>]:BB:DM:CLIST:CATalog?**

**[:SOURce<hw>]:BB:DM:FLIST:CATalog?**

**[:SOURce<hw>]:BB:DM:MLIST:CATalog?**

**[:SOURce<hw>]:BB:DM:DLIST:CATalog?**

Reads out the list files present in the default directory (see [:MMEMory:CDIRECTory](#)).

List type	Command	File extension
Data list	...:DLIST...	*.dm_iqd
Control list	...:CLIST...	*.dm_iqc
User filter files	...:FLIST...	*.vaf
User mapping lists	...:MLIST...	*.vam

Refer to [Section 14.7.2, "Handling files in the default or in a specified directory"](#), on page 906 for general information on file handling in the default and a specific directory.

**Return values:**

<Catalog> "<filename1>,<filename2>,..."  
Returns a string of file names separated by commas.

**Example:** See [Example "Performing general tasks"](#) on page 1061.

**Usage:** Query only

**Manual operation:** See ["Data Source"](#) on page 271  
See ["Select Data List"](#) on page 272  
See ["Directory, File List and Filename"](#) on page 710

```
[ :SOURce<hw>]:BB:DM:CLIST:SElect <Filename>
[:SOURce<hw>]:BB:DM:FLIST:SElect <Filename>
[:SOURce<hw>]:BB:DM:MLIST:SElect <Filename>
[:SOURce<hw>]:BB:DM:DLIST:SElect <Select>
```

Selects the specified list file from the default directory (see [:MMEMory:CDIRectory](#)) or in the directory specified with the complete file path.

If a list with the specified name does not yet exist, it is created. The file extension can be omitted.

Refer to [Section 14.7.2, "Handling files in the default or in a specified directory"](#), on page 906 for general information on file handling in the default and a specific directory.

List type	Command	File extension
Data list	...:DLIST...	*.dm_iqd
Control list	...:CLIST...	*.dm_iqc
User standard	...:ULIST...	*.dm_stu
User filter files	...:FLIST...	*.vaf
User mapping lists	...:MLIST...	*.vam

**Parameters:**

<Select> <list name>

**Example:** See [Example "Performing general tasks"](#) on page 1061

**Manual operation:** See ["Data Source"](#) on page 271  
See ["Select Data List"](#) on page 272  
See ["Functions for handling of data lists"](#) on page 717

```
[ :SOURce<hw>]:BB:DM:CLIST:DElete <Filename>
[:SOURce<hw>]:BB:DM:FLIST:DElete <Filename>
```

**[ :SOURce<hw> ]:BB:DM:MLIST:DELeTe <Filename>**

**[ :SOURce<hw> ]:BB:DM:DLIST:DELeTe <Filename>**

Deletes the specified list from the default directory (see [:MMEMory:CDIRectory](#)) or from the directory specified with the complete file path.

Refer to [Section 14.7.2, "Handling files in the default or in a specified directory"](#), on page 906 for general information on file handling in the default and a specific directory.

List type	Command	File extension
Data list	...:DLIST...	*.dm_iqd
Control list	...:CLIST...	*.dm_iqc
User standard	...:ULIST...	*.dm_stu
User filter files	...:FLIST...	*.vaf
User mapping lists	...:MLIST...	*.vam

**Setting parameters:**

<Filename>            string

**Example:**            See [Example "Performing general tasks"](#) on page 1061

**Usage:**                Setting only

**Manual operation:**   See ["Select Data List"](#) on page 272

**[ :SOURce<hw> ]:BB:DM:CLIST:FREE?**

**[ :SOURce<hw> ]:BB:DM:FLIST:FREE?**

**[ :SOURce<hw> ]:BB:DM:MLIST:FREE?**

**[ :SOURce<hw> ]:BB:DM:DLIST:FREE?**

Queries the list free memory.

List type	Command	File extension
Data list	...:DLIST...	*.dm_iqd
Control list	...:CLIST...	*.dm_iqc
User filter files	...:FLIST...	*.vaf
User mapping lists	...:MLIST...	*.vam

**Return values:**

<Free>                integer

Range:                0 to INT\_MAX

\*RST:                 0

**Example:**            See [Example "Performing general tasks"](#) on page 1061

**Usage:**                Query only



**[[:SOURce<hw>]:BB:DM:CLIST:POINTs?**

Queries the number of lines (2 bytes) in the currently selected list.

**Return values:**

<Points>                    integer  
                               Range:     0 to INT\_MAX  
                               \*RST:     0

**Example:**

```
SOURce:BB:DM:CLIST:SElect "c_list"
SOURce:BB:DM:CLIST:POINTs?
// 20
// the control list consists of 20 lines
```

**Usage:**                    Query only

**Options:**                 R&S SMW-B10

**[[:SOURce<hw>]:BB:DM:DLIST:POINTs <Points>**

Defines the number of bits in the selected data list to be utilized. When a list is being filled with block data, this data is only ever sent in multiples of 8 bits. However the exact number of bits to be exploited can be set to a different figure. The superfluous bits in the list are then ignored.

**Parameters:**

<Points>                    integer  
                               Range:     0 to INT\_MAX  
                               \*RST:     0

**Example:**

```
SOURce:BB:DM:DLIST:POINTs 234
```

Defines the number of bits in the data list to be utilized as 234 bits. If the list was filled with block data, at least the last 6 bits are ignored.

**[[:SOURce<hw>]:BB:DM:FLIST:POINTs?****[[:SOURce<hw>]:BB:DM:MLIST:POINTs?**

Queries the user modulation mapping/user filter list length.

**Return values:**

<Points>                    integer  
                               Range:     max  
                               \*RST:     0

**Example:**

```
BB:DM:FORM USER
BB:DM:MLIS:POIN?
```

**Usage:**                    Query only

---

```
[ :SOURce<hw>]:BB:DM:CLIST:COPY <Filename>
```

```
[ :SOURce<hw>]:BB:DM:DLIST:COPY <Filename>
```

Copies the selected data list (\*.dm\_iqd)/ control list (\*.dm\_iqc) as a new list with name specified by <Filename>. If a list with the specified name exists, it is overwritten. If it does not yet exist, it is created.

The source file has to be available in the default directory (see :MMEMory:CDIRectory).

Refer to [Section 14.7.2, "Handling files in the default or in a specified directory"](#), on page 906 for general information on file handling in the default and a specific directory.

**Setting parameters:**

<Filename>                    string

**Example:**                    See [Example "Performing general tasks"](#) on page 1061

**Usage:**                        Setting only

**Manual operation:**    See ["Select Data List"](#) on page 272

---

```
[ :SOURce<hw>]:BB:DM:CLIST:DATA <Data>
```

Sends the data to the currently selected control list. If the list already contains data, it is *overwritten*. This command only writes data into the data section of the file.

The values for the control signals are sent, arranged in an 8-bit value as defined in [Table 14-5](#).

**Table 14-5: Contents of a control lists**

Signal	Order	Decimal value of bits
Marker 1	LSB	1
Marker 2		2
Marker 3		4
Burst	LSB	16
LevAtt1	LSB	32
CWMod	LSB	64
Hop	MSB	128

The data can also be sent as a binary block, each binary block being a 2-byte value in which the 16 bits represent the binary values (16-bit unsigned integer, 2 bytes, LSB first).

When binary data transmission is in use, use the command :SYSTEM:COMMunicate:GPIB:LTERminator EOI to set the termination character mode to 'EOI control data message only' so that a random LF in the data sequence is not interpreted as End, thereby prematurely terminating the data transmission. The command ...LTER STAN resets the mode.

According to the specifications, the byte sequence is defined as 'most significant byte first'.

**Tip:** Control lists are created in binary format. You may however need the control list in an ASCII format, e.g for creating a waveform file with R&S WinIQSIM2. Refer to the examples in [Section 5.7.4.7, "Creating control lists with tag file format"](#), on page 332 for description on how to create a control list file in ASCII format manually.

\*RST has no effect on data lists.

**Setting parameters:**

<Data> string

**Example:**

```
:MMEMory:CDirectory "/var/user/clists"
:SOURce1:BB:DM:CLIST:SElect "clist_marker3"
:SOURce1:BB:DM:CLIST:DATA 0,0,0,0,4,4,4,0,0,0,0...
// Enters the control values in the selected list.
// In the example, only ramps for Marker 3 are set.
```

**Usage:** Setting only

**Options:** R&S SMW-B10

**Manual operation:** See ["Select Ramp to Edit"](#) on page 286

**[ :SOURce<hw> ]:BB:DM:DLIST:DATA <Data>**

**[ :SOURce<hw> ]:BB:DM:DLIST:DATA? [<Start>[, <Count>]]**

The **Setting** command sends the bit data to the selected data list. Any existing content in the list is *overwritten*. This command only writes data into the data section of the file.

Data can be sent as block data in binary or packet format (`:FORMat ASCii | PACKed`), each byte being interpreted as 8 data bits.

When binary data transmission is in use, use the command `:SYSTem:COMMunicate:GPIB:LTERminator EOI` to set the termination character mode to 'EOI control data message only' so that a random LF in the data sequence is not interpreted as End, thereby prematurely terminating the data transmission. The command `...LTER STAN` resets the mode.

According to the specifications, the byte sequence is defined as 'most significant byte first'.

The **query** reads out the data part of the list file. If the query is expanded by using the two parameters <Start> and <Count>, the list is read out in smaller sections. Without the parameters the total length is always read out starting from address 1.

\*RST has no effect on data lists.

**Parameters:**

<Data> integer

bit data

**Query parameters:**

<Start>	integer	
	Range:	1 to 2147483647
<Count>	integer	
	Range:	1 to 2147483647

**Example:** See [Example "Performing general tasks"](#) on page 1061

**[ :SOURce<hw>]:BB:DM:DLIST:DATA:APPend <Bits>**

Appends the bit data onto the end of the existing data in the selected data list. Existing content in the data list is not overwritten. Hence, you can create long data lists piece-meal.

The command cannot be used with an empty data list, like for example data lists that has just been created. Use the command `[ :SOURce<hw>]:BB:DM:DLIST:DATA` first and enter modulation data in the list.

\*RST has no effect on data lists.

**Setting parameters:**

<Bits> 0 | 1 {0 | 1} | block data

**Example:** See [Example "Performing general tasks"](#) on page 1061

**Usage:** Setting only

**[ :SOURce<hw>]:BB:DM:CLIST:TAG?****[ :SOURce<hw>]:BB:DM:DLIST:TAG?**

Queries the content of the specified tag in the selected file.

**Return values:**

<Tag> <control list>,<tag name>  
Refer to [Section 5.7.5, "Tags for waveforms, data and control lists"](#), on page 335 for description of the available tag formats.

**Example:** `SOURce1:BB:DM:DLIST:TAG? "D_list","date"`  
Queries the Date tag in list D\_list.

**Usage:** Query only

**14.19.5.3 SOURce:BB:ARbitrary subsystem**

This section list the commands of the SOURce:BB:ARbitrary subsystem.

**Suffixes in the keywords ENTity<ch> and SOURce<hw>**

You can address multiple entity configurations by using the SCPI commands starting with the keyword SOURce or the alias commands starting with the keyword ENTity.

**Table 14-6: Suffix ranges for ENTity<ch> and SOURce<hw> with multiple entities**

SCPI syntax	ENTity<ch>	SOURce<hw>
SOURce<hw>:BB:...	-	1 to 8
ENTity<ch>:SOURce<hw>:BB:...	1	1 to 8
	2 to 4	1 to 4

See also [Section 14.3, "SCPI command aliases for advanced mode with multiple entities"](#), on page 896.

### Required options

See [Section 5.7.1, "Required options"](#), on page 303.

The commands are grouped in the following sections:

- [Programming examples](#)..... 1093
- [General commands](#)..... 1101
- [Test signal commands](#)..... 1102
- [Waveform commands](#)..... 1106
- [Multi-segment commands](#)..... 1111
- [Multi-segment sequencing commands](#)..... 1116
- [Multicarrier commands](#)..... 1120
- [Notch filter commands](#)..... 1132
- [Trigger commands](#)..... 1135
- [Marker commands](#)..... 1146
- [Clock commands](#)..... 1148

### Programming examples

#### Example: To create test signals

This example provides the commands to configure the different test signals.

```
// *****
// Reset the instrument first.
// *****
*RST; *CLS
:SOURce1:BB:ARbitrary:PRESet

// *****
// Create test signals.
// *****
:SOURce1:BB:ARbitrary:SIGNAL:TYPE CIQ
:SOURce1:BB:ARbitrary:TSIGNAL:CIQ:I -0.5
:SOURce1:BB:ARbitrary:TSIGNAL:CIQ:Q -0.33
:SOURce1:BB:ARbitrary:TSIGNAL:CIQ:CREate

:SOURce1:BB:ARbitrary:TSIGNAL:SINE:FREQuency 1MHz
:SOURce1:BB:ARbitrary:TSIGNAL:SINE:SAMPles 100
:SOURce1:BB:ARbitrary:TSIGNAL:SINE:PHASE -90
```

```
:SOURce1:BB:ARbitrary:TSIGnal:SINE:CREate:NAMed "/var/user/sine_test"

:SOURce1:BB:ARbitrary:TSIGnal:RECTangle:FREQuency 100kHz
:SOURce1:BB:ARbitrary:TSIGnal:RECTangle:SAMPles 1000
:SOURce1:BB:ARbitrary:TSIGnal:RECTangle:AMPLitude 0.5
:SOURce1:BB:ARbitrary:TSIGnal:RECTangle:OFFSet -0.3
:SOURce1:BB:ARbitrary:TSIGnal:RECTangle:CREate:NAMed "/var/user/rect_test"

:SOURce1:BB:ARbitrary:STATe ON
```

### Example: To manage waveform files

The following example lists the commands provided for handling of waveform files.

```
// *****
// Reset instrument first
// *****
*RST; *CLS
:SOURce1:BB:ARbitrary:PRESet

// *****
// Set the default directory and list the available waveform files
// *****
MMEM:CDIR "/var/user/ARBtestSigs"
:SOURce1:BB:ARbitrary:WAVEform:CATALog?
// sineTest,rectTest,cigTestSignal,waveformTest,test2
:SOURce1:BB:ARbitrary:WAVEform:CATALog:LENGth?
// Response is the number of files: "5"
// Optionally query free disk space.
:SOURce1:BB:ARbitrary:WAVEform:FREE?

// *****
// Select a waveform and query information
// *****
:SOURce1:BB:ARbitrary:WAVEform:DELeTe "/var/user/ARBtestSigs/test2"
:SOURce1:BB:ARbitrary:WAVEform:SELeCt "/var/user/ARBtestSigs/wvTest"
:SOURce1:BB:ARbitrary:WAVEform:POINts?
// 100
:SOURce1:BB:ARbitrary:WAVEform:TAG? "TYPE"
// "SMU-WV"
:SOURce1:BB:ARbitrary:WAVEform:TAG? "COMMENT"
// "Waveform for test purposes"
// alternatively: query the comment tag of the current waveform file
:SOURce1:BB:ARbitrary:WAVEform:DATA?
// Response is the comment: "Waveform for test purposes"
// Query the date tag of a specific waveform file.
:SOURce1:BB:ARbitrary:WAVEform:DATA? "/var/user/ARBtestSigs/waveformTest","date"
// Response: #2192014-04-15;16:19:30

// *****
// Trigger signal generation with the second baseband signal path.
// *****
```

```
:SOURcel:BB:ARbitrary:TRIGger:SOURce INTB
// the internal trigger signal from the other path must be used
:SOURcel:BB:ARbitrary:TRIGger:OBASeband:DELay 25
:SOURcel:BB:ARbitrary:TRIGger:OBASeband:INHibit 10
```

### Example: To configure marker signals

This example provides the commands to configure the marker signals.

```
// *****
// Configure and enable standard marker signals
// *****
SOURcel:BB:ARbitrary:TRIGger:OUTPut1:MODE REStart
SOURcel:BB:ARbitrary:TRIGger:OUTPut1:MODE RATio
SOURcel:BB:ARbitrary:TRIGger:OUTPut1:ONTime 40
SOURcel:BB:ARbitrary:TRIGger:OUTPut1:OFFTime 20
// *****
// Configure a pulsed marker signal.
// *****
SOURcel:BB:ARbitrary:TRIGger:OUTPut1:MODE PULSe
SOURcel:BB:ARbitrary:TRIGger:OUTPut1:PULSe:DIVider 5
SOURcel:BB:ARbitrary:TRIGger:OUTPut1:PULSe:FREQuency?
// Response in Hz: "2000000"
SOURcel:BB:ARbitrary:TRIGger:OUTPut1:DELay 16
// *****
// Configure a pattern marker signal.
// *****
SOURcel:BB:ARbitrary:TRIGger:OUTPut1:MODE PATtern
SOURcel:BB:ARbitrary:TRIGger:OUTPut1:PATtern #HE0F52,20
```

### Example: To configure clock settings

This example provides the commands to configure the clock settings.

```
// *****
// Clock settings
// *****
SOURcel:BB:ARbitrary:CLOCk:SOURce INTernal
SOURcel:BB:ARbitrary:CLOCk?
// Response in Hz: "1000000"
// The clock frequency is 1 MHz.
// Or alternatively use the following tag:
SOURcel:BB:ARbitrary:WAVEform:TAG? "CLOCK"
```

### Example: To enable HDD waveform streaming

The following example provides commands to enable and query waveform streaming from an HDD connected to the R&S SMW200A.

```
SOURcel:BB:ARbitrary:WAVEform:HDDStreaming:STATe ON
SOURcel:BB:ARbitrary:WAVEform:HDDStreaming:BLEVel?
// Response in percent: "94"
```

**Example: Creating a multi-segment waveform**

The following example lists the commands necessary to create a multi-segment waveform.

```
// *****
// Reset instrument first
// *****
*RST; *CLS
// :SOURcel:BB:ARbitrary:PRESet

// *****
// Set the default directory and list the available waveform files
// *****
:MMEM:CDIR "/var/user/ARB/multi_segment"
:SOURcel:BB:ARbitrary:WAVEform:CATalog:LENGth?
// 4
:SOURcel:BB:ARbitrary:WAVEform:CATalog?
// Seg_0, Seg_1, Seg_2, Seg_3
// *****
// List the available configuration files and select/create file
// *****
:SOURcel:BB:ARbitrary:WSEGment:CONFigure:CATalog?
// multi_segment,ms_waveform
// the directory contains the configuration files multi_segment.inf_mswv
and ms_waveform.inf_mswv
:SOURcel:BB:ARbitrary:WSEGment:CONFigure:DELeTe "ms_waveform.inf_mswv"
:SOURcel:BB:ARbitrary:WSEGment:CONFigure:SELEct
"/var/user/ARB/multi_segment/config.inf_mswv"
// Creates an empty configuration file "config.inf_mswv".

// *****
// Append waveforms to the multi segment sequence
// *****
:SOURcel:BB:ARbitrary:WSEGment:CONFigure:SEGment:APPend "Seg_0"
// Waveform Seg_0.wv will be the first segment of a
// multi segment waveform created with configuration file config.inf_mswv
:SOURcel:BB:ARbitrary:WSEGment:CONFigure:SEGment:APPend "Seg_1"
:SOURcel:BB:ARbitrary:WSEGment:CONFigure:SEGment:APPend "Seg_2"
:SOURcel:BB:ARbitrary:WSEGment:CONFigure:SEGment:APPend "Seg_3"
:SOURcel:BB:ARbitrary:WSEGment:CONFigure:BLANK:APPend 1000,100000000
// adds a blank segment with 1000 samples and 100 MHz clock rate
:SOURcel:BB:ARbitrary:WSEGment:CONFigure:SEGment:INDEX0:DOWN
// Changes the segment order by shifting the first segment behind the second.
// segment. You can also move later segments up or delete segments.
:SOURcel:BB:ARbitrary:WSEGment:CONFigure:SEGment:INDEX1:UP
:SOURcel:BB:ARbitrary:WSEGment:CONFigure:SEGment:INDEX2:DELeTe
:SOURcel:BB:ARbitrary:WSEGment:CONFigure:LEVel:MODE ERMS
:SOURcel:BB:ARbitrary:WSEGment:CONFigure:CLOCK:MODE HIGHEst
// :SOURcel:BB:ARbitrary:WSEGment:CONFigure:CLOCK:MODE USER
// :SOURcel:BB:ARbitrary:WSEGment:CONFigure:CLOCK 30000000
:SOURcel:BB:ARbitrary:WSEGment:CONFigure:MARKer:MODE TAKE
```



```

:SOURcel:BB:ARbitrary:WSEgment:CONFigure:SElect
"/var/user/ARB/multi_segment/config.inf_mswv"
:SOURcel:BB:ARbitrary:WSEgment:CONFigure:COMment "Multi Segment File"
:SOURcel:BB:ARbitrary:WSEgment:CONFigure:OFILe "ms_0to3"
:SOURcel:BB:ARbitrary:WSEgment:CONFigure:SEGment:CATalog?
// /var/user/ARB/multi_segment/Seg_0.wv, /var/user/ARB/multi_segment/Seg_1.wv,
// /var/user/ARB/multi_segment/Seg_2.wv, /var/user/ARB/multi_segment/Seg_3.wv

// *****
// Create and load the multi segment waveforms
// *****
// The first segment is output depending on the trigger settings.
:SOURcel:BB:ARbitrary:WSEgment:CREate "/var/user/ARB/multi_segment/config.inf_mswv"
:SOURcel:BB:ARbitrary:WSEgment:CLOad "/var/user/ARB/multi_segment/config.inf_mswv"
:SOURcel:BB:ARbitrary:TRIGger:SEquence AAUto
:SOURcel:BB:ARbitrary:TRIGger:SOURce INTernal
:SOURcel:BB:ARbitrary:STAT ON
:SOURcel:BB:ARbitrary:TRIGger:EXEC

```

### Example: Configuring the output order of the segments

The following example lists the commands necessary to trigger the output of the segments in the desired playback order. The example lists only the relevant commands. We assume that the multi-segment sequence `ms_0to3` composed of four segments, `Seg_0`, `Seg_1`, `Seg_2` and `Seg_3` is created and loaded in the ARB (see [Example "Creating a multi-segment waveform"](#) on page 1096). The required output order of the segments is `Seg_0`, `Seg_3 [2]`, `Seg_2`.

```

// *****
// Select a multi segment waveform
// *****
:MMEM:CDIR "/var/user/ARB/multi_segment"
:SOURcel:BB:ARbitrary:WSEgment:CONFigure:CATalog?
// config
:SOURcel:BB:ARbitrary:WSEgment:CONFigure:SElect "config"
:SOURcel:BB:ARbitrary:WSEgment:CONFigure:OFILe?
// "/var/user/ARB/multi_segment/ms_0to3"
:SOURcel:BB:ARbitrary:WSEgment:CLOad "/var/user/ARB/multi_segment/config.inf_mswv"

// *****
// Adjust trigger settings and enable the ARB
// *****
:SOURcel:BB:ARbitrary:TRIGger:SEquence AAUto
:SOURcel:BB:ARbitrary:TRIGger:SOURce INTernal
:SOURcel:BB:ARbitrary:STATe ON

// *****
// Select the next segment trigger mode and source
// *****
:SOURcel:BB:ARbitrary:TRIGger:SMODE NEXT
// :SOURcel:BB:ARbitrary:TRIGger:SMODE NSEam
:SOURcel:BB:ARbitrary:WSEgment:NEXT:SOURce INTernal

```

```

:SOURcel:BB:ARbitrary:WSEgment?
// 0
:SOURcel:BB:ARbitrary:WSEgment:NAME?
// "/var/user/ARB/multi_segment/Seg_0.wv"
// Seg_0 is output continuously

// *****
// Trigger a switch over to the next segment
// *****
:SOURcel:BB:ARbitrary:WSEgment:NEXT 3
// stops Seg_0 and starts immediatly Seg_3; Seg_3 is output continuously
:SOURcel:BB:ARbitrary:TRIGger:EXECute
//restarts Seg_3
:SOURcel:BB:ARbitrary:WSEgment:NEXT 2
:SOURcel:BB:ARbitrary:WSEgment:NEXT 0

// *****
// Scrolling trough the segments, i.e. shwitch over in incremental order
// *****
:SOURcel:BB:ARbitrary:WSEgment:NEXT:EXECute
:SOURcel:BB:ARbitrary:WSEgment?
// 1
:SOURcel:BB:ARbitrary:WSEgment:NEXT:EXECute
:SOURcel:BB:ARbitrary:WSEgment?
// 2

```



For configuring waveform segments in manual operation of the instrument, see ["To switch output segments manually"](#) on page 383.

### Example: Using the ARB sequencer

The following example lists the commands necessary to configure a play list. The example lists only the relevant commands.

We assume that the multi-segment sequence `ms_0to3` composed of four segments, `Seg_0`, `Seg_1`, `Seg_2` and `Seg_3` is created and loaded in the ARB (see [Example "Creating a multi-segment waveform"](#) on page 1096). The required output order of the segments is `Seg_0`, `Seg_3 [2]`, `Seg_2`.



The ARB sequencer mode requires waveform files with equal clock rate.

```

// *****
// Select a multi-segment waveform with equal segment clock rates.
// *****
:MMEM:CDIR "/var/user/ARB/multi_segment"
:SOURcel:BB:ARbitrary:WSEgment:CONFigure:CATalog?
// config
:SOURcel:BB:ARbitrary:WSEgment:CONFigure:SElect "config"
:SOURcel:BB:ARbitrary:WSEgment:CLoad "/var/user/ARB/multi_segment/config.inf_mswv"

```

```

:SOURce1:BB:ARbitrary:WSEgment:CONFigure:OFILe?
// Response: "/var/user/ARB/multi_segment/ms_0to3.wv"

// *****
// Select a sequencing list (*.wvs).
// *****
:SOURce1:BB:ARbitrary:WSEgment:SEquence:SElect "play_list"
:SOURce1:BB:ARbitrary:WSEgment:SEquence:APPend ON,0,1,NEXT
// Adds the segment number 0 as a new (first) segment in the sequencing list.
// This segment is activ and will be repeated once followed by the next segment.
:SOURce1:BB:ARbitrary:WSEgment:SEquence:APPend ON,3,2,NEXT
:SOURce1:BB:ARbitrary:WSEgment:SEquence:APPend ON,2,1,SEGO

:SOURce1:BB:ARbitrary:TRIGger:SMODE SEQuencer
:SOURce1:BB:ARbitrary:TRIGger:SEquence AAUto
:SOURce1:BB:ARbitrary:TRIGger:SOURce INTernal
:SOURce1:BB:ARbitrary:STAT ON
:SOURce1:BB:ARbitrary:TRIGger:EXEC

```



For configuring waveform segments in manual operation of the instrument, see ["To switch output segments manually"](#) on page 383.

#### Example: Adding extra marker signals

The following example lists the commands necessary to add two marker signals, a sequence restart marker and a segment restart marker, to the multi-segment sequence. The example lists only the relevant commands.

```

// *****
// Select the multi segment file and the corresponding configuration list.
// *****
:MMEM:CDIR "/var/lists/ARB/multi_segment"
:SOURce1:BB:ARbitrary:WSEgment:CONFigure:CATalog?
// Response: "config"
:SOURce1:BB:ARbitrary:WSEgment:CONFigure:SElect "config"
:SOURce1:BB:ARbitrary:WSEgment:CLoad "/var/user/ARB/multi_segment/config.inf_mswv"
:SOURce1:BB:ARbitrary:WSEgment:CONFigure:OFILe?
// "/var/user/ARB/multi_segment/ms_0to3.wv"

// *****
// Enable restart markers on marker trace 1 and 2.
// *****
:SOURce1:BB:ARbitrary:WSEgment:CONFigure:MARKer:MODE IGNore
:SOURce1:BB:ARbitrary:WSEgment:CONFigure:MARKer:FSEgment MRK1
:SOURce1:BB:ARbitrary:WSEgment:CONFigure:MARKer:ESEgment MRK2

:SOURce1:BB:ARbitrary:TRIGger:OUTPut1:MODE UNCHanged
:SOURce1:BB:ARbitrary:TRIGger:OUTPut2:MODE UNCHanged

```

**Example: To generate a multicarrier signal**

The following example lists the commands to configure and generate an ARB multicarrier signal.

```
// *****
// Generating a single-carrier or standard waveform signal.
// *****
// Load a standardized 3GPP downlink test model, e.g. "Test Model 1 16 Channels"
:SOURcel:BB:W3GPP:SETting:TMOdel:BSTation "Test_Model_1_16channels"
// Confirm that the standardized 3GPP downlink test model is currently selected
:SOURcel:BB:W3GPP:SETting:TMOdel:BSTation?
// "Test_Model_1_16channels"
// Enable the generation of 3GPP FDD signal
:SOURcel:BB:W3GPP:STATe ON
// Generate a 3GPP FDD ARB waveform file with name "3gpp_arb".
// Save the waveform in the default directory "/var/user".
:SOURcel:BB:W3GPP:WAVEform:CREate "3gpp_arb"

// *****
// Enable a multicarrier scenario with 4 carriers and carrier spacing of 5 MHz.
// *****
:SOURcel:BB:ARbitrary:MCARrier:CARRier:COUNT 4
:SOURcel:BB:ARbitrary:MCARrier:CARRier:SPACing 5 MHz
:SOURcel:BB:ARbitrary:MCARrier:CARRier1:STATe ON
:SOURcel:BB:ARbitrary:MCARrier:CARRier2:STATe ON
:SOURcel:BB:ARbitrary:MCARrier:CARRier3:STATe ON
:SOURcel:BB:ARbitrary:MCARrier:CARRier4:STATe ON

// *****
// Select and load the waveform file "3gpp_arb" to all 4 carriers
// *****
// The file "3gpp_arb" is in default directory "/var/user".
:SOURcel:BB:ARbitrary:MCARrier:CARRier1:FILE "3gpp_arb"
:SOURcel:BB:ARbitrary:MCARrier:CARRier2:FILE "3gpp_arb"
:SOURcel:BB:ARbitrary:MCARrier:CARRier3:FILE "3gpp_arb"
:SOURcel:BB:ARbitrary:MCARrier:CARRier4:FILE "3gpp_arb"

// *****
// Trigger the signal caulation and load the waveform in the ARB generator
// *****
// Define the file name of the multi carrier output file, e.g. "3gpp_mc"
:SOURcel:BB:ARbitrary:MCARrier:OFIle "3gpp_mc"
// Create and load the multi carrier waveform file in the ARB generator
:SOURcel:BB:ARbitrary:MCARrier:CLOad
// Alternatively: create the multi carrier waveform and
// load it subsequently in the ARB generator
// :SOURcel:BB:ARbitrary:MCARrier:CREate
// :SOURcel:BB:ARbitrary:WAVEform:SElect"3gpp_mc"

// Activate the ARB generator
:SOURcel:BB:ARbitrary:STATe ON
```

```
// *****
// Use the save and recall function.
// *****
// Query available settings files in a specified directory
MME:CDIR "/var/user/waveform"
:SOURce1:BB:ARbitrary:MCARrier:SETting:CATalog?
// mcar1, mcar2
// the directory contains the settings files mcar1.arb_multcarr and mcar2.arb_multcarr
:SOURce1:BB:ARbitrary:MCARrier:SETting:STORe "3gpp_mc"
```

### Example: Generating AWGN test signal

```
SOURce1:BB:ARbitrary:SIGNal:TYPE AWGN
SOURce1:BB:ARbitrary:TSIGNal:AWGN:SAMPles 1000000
SOURce1:BB:ARbitrary:TSIGNal:AWGN:CREate

SOURce1:BB:ARbitrary:STATe 1
```

### Example: Creating notch filter

```
SOURce1:BB:ARbitrary:CLOCK 1000000
SOURce1:BB:ARbitrary:NOTCh:CLOCK?
// 1000000
SOURce1:BB:ARbitrary:NOTCh1:COUNT 3

SOURce1:BB:ARbitrary:NOTCh1:STATe 1
SOURce1:BB:ARbitrary:NOTCh1:FREQuency:OFFSet 0
SOURce1:BB:ARbitrary:NOTCh1:BWIDth:RELative 3
SOURce1:BB:ARbitrary:NOTCh1:BWIDth:ABSolute?
// 30000

SOURce1:BB:ARbitrary:NOTCh2:FREQuency:OFFSet -25000000
SOURce1:BB:ARbitrary:NOTCh2:BWIDth:ABSolute 20000
SOURce1:BB:ARbitrary:NOTCh2:BWIDth:RELative?
// 2
SOURce1:BB:ARbitrary:NOTCh3:FREQuency:OFFSet 25000000
SOURce1:BB:ARbitrary:NOTCh3:BWIDth:ABSolute 5000
SOURce1:BB:ARbitrary:NOTCh3:BWIDth:RELative 0.5

SOURce1:BB:ARbitrary:NOTCh1:APPLY
SOURce1:BB:ARbitrary:NOTCh 1
SOURce1:BB:ARbitrary:STATe 1
```

## General commands

---

### [:SOURce<hw>]:BB:ARbitrary:PRESet

Sets all ARB generator parameters to their default values.

**Example:** See [Example "To create test signals"](#) on page 1093.

**Usage:** Event

**Manual operation:** See ["Set To Default"](#) on page 311

---

**[:SOURce<hw>]:BB:ARbitrary:STATe <State>**

Enables the ARB generator.

A waveform must be selected before the ARB generator is activated.

**Parameters:**

<State> 1 | ON | 0 | OFF  
\*RST: 0

**Example:** See [Example "To create test signals"](#) on page 1093.

**Manual operation:** See ["State"](#) on page 311

---

**[:SOURce<hw>]:BB:ARbitrary:PRAMP[::STATe] <ArbPramState>**

If activated, the burst gate marker signal included in the ARB waveform file is used as marker signal for the pulse modulator.

**Parameters:**

<ArbPramState> 1 | ON | 0 | OFF  
\*RST: 0

**Example:**

```
SOURce1:BB:ARbitrary:WAVEform:SElect "/var/user/Pulse_PMod_Burst"
SOURce1:BB:ARbitrary:PRAMP:STATe 1
SOURce1:BB:ARbitrary:STATe 1
```

**Options:** R&S SMW-K22

**Manual operation:** See ["RF Power Ramping with Burst Marker"](#) on page 313

**Test signal commands**

<b>[:SOURce&lt;hw&gt;]:BB:ARbitrary:SIGNal:TYPE</b> .....	1103
<b>[:SOURce&lt;hw&gt;]:BB:ARbitrary:TSIGNal:CIQ:I</b> .....	1103
<b>[:SOURce&lt;hw&gt;]:BB:ARbitrary:TSIGNal:CIQ:Q</b> .....	1103
<b>[:SOURce&lt;hw&gt;]:BB:ARbitrary:TSIGNal:RECTangle:AMPLitude</b> .....	1103
<b>[:SOURce&lt;hw&gt;]:BB:ARbitrary:TSIGNal:RECTangle:FREQuency</b> .....	1103
<b>[:SOURce&lt;hw&gt;]:BB:ARbitrary:TSIGNal:RECTangle:OFFSet</b> .....	1104
<b>[:SOURce&lt;hw&gt;]:BB:ARbitrary:TSIGNal:RECTangle:SAMPles</b> .....	1104
<b>[:SOURce&lt;hw&gt;]:BB:ARbitrary:TSIGNal:SINE:FREQuency</b> .....	1104
<b>[:SOURce&lt;hw&gt;]:BB:ARbitrary:TSIGNal:SINE:PHASe</b> .....	1105
<b>[:SOURce&lt;hw&gt;]:BB:ARbitrary:TSIGNal:SINE:SAMPles</b> .....	1105
<b>[:SOURce&lt;hw&gt;]:BB:ARbitrary:TSIGNal:CIQ:CREate:NAMed</b> .....	1105
<b>[:SOURce&lt;hw&gt;]:BB:ARbitrary:TSIGNal:RECTangle:CREate:NAMed</b> .....	1105
<b>[:SOURce&lt;hw&gt;]:BB:ARbitrary:TSIGNal:SINE:CREate:NAMed</b> .....	1105
<b>[:SOURce&lt;hw&gt;]:BB:ARbitrary:TSIGNal:CIQ:CREate</b> .....	1106
<b>[:SOURce&lt;hw&gt;]:BB:ARbitrary:TSIGNal:RECTangle:CREate</b> .....	1106

<a href="#">[:SOURce&lt;hw&gt;]:BB:ARbitrary:TSIGnal:SINE:CREate.....</a>	1106
<a href="#">[:SOURce&lt;hw&gt;]:BB:ARbitrary:TSIGnal:AWGN:SAMPles.....</a>	1106
<a href="#">[:SOURce&lt;hw&gt;]:BB:ARbitrary:TSIGnal:AWGN:CREate.....</a>	1106

---

**[:SOURce<hw>]:BB:ARbitrary:SIGnal:TYPE <ArbSignalType>**

Selects the type of test signal.

**Parameters:**

<ArbSignalType> SINE | RECT | CIQ | AWGN  
 \*RST: SINE

**Example:** See [Example "To create test signals"](#) on page 1093.

**Options:** AWGN requires R&S SMW-K811

**Manual operation:** See ["Test Signal Form"](#) on page 313

---

**[:SOURce<hw>]:BB:ARbitrary:TSIGnal:CIQ:I <I>**  
**[:SOURce<hw>]:BB:ARbitrary:TSIGnal:CIQ:Q <TSig>**

Sets the value for the I and Q component of the test signal

**Parameters:**

<TSig> float  
 Range: -1 to 1  
 Increment: 0.001  
 \*RST: 0  
 Default unit: FS

**Example:** See [Example "To create test signals"](#) on page 1093.

**Manual operation:** See ["I Value/Q Value"](#) on page 317

---

**[:SOURce<hw>]:BB:ARbitrary:TSIGnal:RECTangle:AMPLitude <Amplitude>**

Sets the digital amplitude of the rectangular wave.

**Parameters:**

<Amplitude> float  
 Range: 0 to 1  
 Increment: 0.001  
 \*RST: 0.800  
 Default unit: FS

**Example:** See [Example "To create test signals"](#) on page 1093.

**Manual operation:** See ["Amplitude"](#) on page 316

---

**[:SOURce<hw>]:BB:ARbitrary:TSIGnal:RECTangle:FREQuency <Frequency>**

Sets the frequency of the test signal.

**Parameters:**

<Frequency> float  
 Range: 100 to depends on the installed options  
 Increment: 0.01  
 \*RST: 1000  
 Default unit: Hz

**Example:** See [Example "To create test signals"](#) on page 1093.

**Manual operation:** See ["Frequency"](#) on page 316

**[:SOURce<hw>]:BB:ARbitrary:TSIGnal:RECTangle:OFFSet <Offset>**

Sets the DC component.

**Parameters:**

<Offset> float  
 Range: -1 to 1  
 Increment: 0.001  
 \*RST: 0  
 Default unit: FS

**Example:** See [Example "To create test signals"](#) on page 1093.

**Manual operation:** See ["Offset DC"](#) on page 316

**[:SOURce<hw>]:BB:ARbitrary:TSIGnal:RECTangle:SAMPles <Samples>**

Sets the number of sample values required for the rectangular signal per period.

**Parameters:**

<Samples> integer  
 Range: 4 to 1000  
 \*RST: 100

**Example:** See [Example "To create test signals"](#) on page 1093.

**Manual operation:** See ["Samples per Period"](#) on page 316

**[:SOURce<hw>]:BB:ARbitrary:TSIGnal:SINE:FREQuency <Frequency>**

Sets the frequency of the simple sinusoidal test signal.

**Parameters:**

<Frequency> float  
 Range: 100 to depends on the installed options  
 Increment: 0.01  
 \*RST: 1000  
 Default unit: Hz

**Example:** See [Example "To create test signals"](#) on page 1093.

**Manual operation:** See ["Frequency"](#) on page 314



---

**[[:SOURce<hw>]:BB:ARbitrary:TSIGnal:SINE:PHASe <Phase>**

Sets the phase offset of the sine wave on the Q channel relative to the sine wave on the I channel.

**Parameters:**

<Phase> float  
 Range: -180 to 180  
 Increment: 0.01  
 \*RST: 90  
 Default unit: DEG

**Example:** See [Example "To create test signals"](#) on page 1093.

**Manual operation:** See ["Phase Offset Q"](#) on page 315

---

**[[:SOURce<hw>]:BB:ARbitrary:TSIGnal:SINE:SAMPles <Samples>**

Sets the sample rate for the sine signal in samples per period.

Make sure that the resulting clock rate does not exceed the maximum ARB clock rate. The maximum value is automatically restricted by reference to the set frequency and has to fulfill the rule *Frequency \* Samples <= ARB clock rate*.

For more information, refer to the specifications document.

**Parameters:**

<Samples> integer  
 Range: 4 to 1000  
 \*RST: 100

**Example:** See [Example "To create test signals"](#) on page 1093.

**Manual operation:** See ["Samples per Period"](#) on page 314

---

**[[:SOURce<hw>]:BB:ARbitrary:TSIGnal:CIQ:CREate:NAMed <Filename>**

**[[:SOURce<hw>]:BB:ARbitrary:TSIGnal:RECTangle:CREate:NAMed <Filename>**

**[[:SOURce<hw>]:BB:ARbitrary:TSIGnal:SINE:CREate:NAMed <Filename>**

Generates a signal and saves it to a waveform file.

**Setting parameters:**

<Filename> string

**Example:** See [Example "To create test signals"](#) on page 1093.

**Usage:** Setting only

**Manual operation:** See ["Generate Signal File"](#) on page 315

---

```
[:SOURce<hw>]:BB:ARbitrary:TSIGnal:CIQ:CREate
[:SOURce<hw>]:BB:ARbitrary:TSIGnal:RECTangle:CREate
[:SOURce<hw>]:BB:ARbitrary:TSIGnal:SINE:CREate
```

Generates a signal and uses it as output straight away.

**Example:** See [Example "To create test signals"](#) on page 1093.

**Usage:** Event

**Manual operation:** See ["Generate Signal RAM"](#) on page 315  
See ["Generate Signal RAM"](#) on page 316

---

```
[:SOURce<hw>]:BB:ARbitrary:TSIGnal:AWGN:SAMPles <ParAwgnSamp>
```

Sets the number of samples generated for the AWGN waveform.

**Parameters:**

<ParAwgnSamp> integer  
Range: 1E6 to 1E9  
\*RST: 1E8

**Example:** See [Example "Generating AWGN test signal"](#) on page 1101.

**Options:** R&S SMW-K811

**Manual operation:** See ["Samples"](#) on page 359

---

```
[:SOURce<hw>]:BB:ARbitrary:TSIGnal:AWGN:CREate
```

Generates a signal and uses it as output straight away.

**Example:** See [Example "Generating AWGN test signal"](#) on page 1101.

**Usage:** Event

**Options:** R&S SMW-K811

**Manual operation:** See ["Generate Signal RAM"](#) on page 360

---

### Waveform commands



The following rule applies for all commands described in this section.

By default, the waveform files are saved in the default directory of the instrument that is the `/var/user/` directory or the directory specified with the command `:MMEMory:CDIRectory`. To access the waveform files in this default directory, only the filename is required, without the path and the file extension (`*.wv`).

However, to access waveform files located in a directory different to the default one, the complete file path and filename are required.

<code>[:SOURce&lt;hw&gt;]:BB:ARBitrary:WAVeform:CATalog?</code>	1107
<code>[:SOURce&lt;hw&gt;]:BB:ARBitrary:WAVeform:CATalog:LENGth?</code>	1107
<code>[:SOURce&lt;hw&gt;]:BB:ARBitrary:WAVeform:SELEct</code>	1107
<code>[:SOURce&lt;hw&gt;]:BB:ARBitrary:WAVeform:DELEte</code>	1108
<code>[:SOURce&lt;hw&gt;]:BB:ARBitrary:WAVeform:FREE?</code>	1108
<code>[:SOURce&lt;hw&gt;]:BB:ARBitrary:WAVeform:POINts?</code>	1108
<code>[:SOURce&lt;hw&gt;]:BB:ARBitrary:WAVeform:DATA</code>	1108
<code>[:SOURce&lt;hw&gt;]:BB:ARBitrary:WAVeform:TAg?</code>	1109
<code>[:SOURce&lt;hw&gt;]:BB:ARBitrary:CLOCK</code>	1110
<code>[:SOURce&lt;hw&gt;]:BB:ARBitrary:COUPLed:STATe</code>	1110
<code>[:SOURce&lt;hw&gt;]:BB:ARBitrary:COUPLed:TRIGger:DELay:OFFSet</code>	1110
<code>[:SOURce&lt;hw&gt;]:BB:ARBitrary:WAVeform:CLOCK</code>	1111

---

### `[:SOURce<hw>]:BB:ARBitrary:WAVeform:CATalog?`

Reads out the files extension \* .wv in the default directory.

#### Return values:

<Catalog> string  
Returns a list of the file names separated by commas

**Example:** See [Example "To manage waveform files"](#) on page 1094.

**Usage:** Query only

---

### `[:SOURce<hw>]:BB:ARBitrary:WAVeform:CATalog:LENGth?`

Reads out the files with extension \* .wv in the default directory and returns the number of waveform files in this directory. The default directory is set using command `MMEM:CDIRectory`.

#### Return values:

<Length> integer  
Number of waveform files in default directory  
Range: 0 to INT\_MAX  
\*RST: 0

**Example:** See [Example "To manage waveform files"](#) on page 1094.

**Usage:** Query only

---

### `[:SOURce<hw>]:BB:ARBitrary:WAVeform:SELEct <Filename>`

Selects an existing waveform file, i.e. file with extension \* .wv.

#### Parameters:

<Filename> string

**Example:** See [Example "To manage waveform files"](#) on page 1094.

**Manual operation:** See ["Load Waveform"](#) on page 312

**[[:SOURce<hw>]:BB:ARbitrary:WAVEform:DELeTe <Filename>**

Deletes the specified waveform file. If the file is not on the default path, the path must be specified at the same time. The file extension may be omitted. Only files with the file extension \* .wv are deleted.

**Setting parameters:**

<Filename>            string

**Example:**            See [Example "To manage waveform files"](#) on page 1094.

**Usage:**                Setting only

**[[:SOURce<hw>]:BB:ARbitrary:WAVEform:FREE?**

Queries the free disk space on the default path of the instrument's hard disk.

**Return values:**

<Free>                integer  
                           Range:      0 to INT\_MAX  
                           \*RST:      1

**Example:**            See [Example "To manage waveform files"](#) on page 1094.

**Usage:**                Query only

**[[:SOURce<hw>]:BB:ARbitrary:WAVEform:POINTs?**

Queries the number of samples (the number of I/Q values pairs) in the selected waveform file.

**Return values:**

<Points>             <waveform filename>  
                           Range:      0 to 1000  
                           \*RST:      1

**Example:**            See [Example "To manage waveform files"](#) on page 1094.

**Usage:**                Query only

**[[:SOURce<hw>]:BB:ARbitrary:WAVEform:DATA <Filename>, <Data>****[[:SOURce<hw>]:BB:ARbitrary:WAVEform:DATA? <Tag>**

The **setting** command writes the binary block data <data> to the file identified by <filename>. The *complete content* of the waveform file (i.e. including all tags) must be specified; the complete content is transmitted as binary data block.

I/Q data and the marker data can also be written to a file with the command : [MMEMory:DATA:UNPRotected](#).

**Tip:** To ensure trouble-free data transmission, set the GPIB delimiter to EOI.

The **query** command retrieves the content of the specified tag of the currently selected waveform file or the waveform file specified with the <filename>.

See also [Section 5.7.5, "Tags for waveforms, data and control lists"](#), on page 335.

**Parameters:**

<Filename> string  
Specifies the name of the waveform file in that the binary data is copied

**Setting parameters:**

<Data> block data  
Binary block data with the following syntax:  
#<Digits><Length><Binary data>  
#  
Indicates the start of the binary block  
**<Digits>**  
Decimal value  
Gives the number of decimal digits used for the <Length> value  
**<Length>**  
Decimal value  
Number of bytes the follow in the <Binary data> part  
**<Binary data>**  
Binary data in ASCII format

**Query parameters:**

<Tag> 'comment' | 'copyright' | 'date' | 'lacpfilter' | 'marker name' | 'poweroffset'

**Example:****Query**

See [Example "To manage waveform files"](#) on page 1094.

**Example:****Setting**

```
SOURce:BB:ARB:WAVEform:DATA "/var/user/test1.wv",#220<binary data>
// Writes the binary block data <binary data> to file test1.wv
// <binary data> contains 20 bytes
// <binary data> is a placeholder;
// the actual ASCII values are not printable
```

**[:SOURce<hw>]:BB:ARBitrary:WAVEform:TAG?**

Queries the content of the specified tag of the selected waveform file (see also [Section 5.7.5, "Tags for waveforms, data and control lists"](#), on page 335).

**Return values:**

<Tag> 'comment' | 'copyright' | 'date' | 'lacpfilter' | 'marker name' | 'poweroffset' | 'samples'

**Example:**

See [Example "To manage waveform files"](#) on page 1094.

**Usage:**

Query only

---

**[[:SOURce<hw>]:BB:ARbitrary:CLOCK <Clock>**

Sets the clock frequency.

If you load a waveform, the clock rate is determined as defined with the waveform tag `{CLOCK: frequency}`. This command subsequently changes the clock rate; see specifications document for value range.

In the case of an external clock source, the clock of the external source must be specified with this command.

For more information, refer to the specifications document.

**Parameters:**

<Clock>	float
	Range: depends on the installed options
	Increment: 0.001
	*RST: 1E6
	Default unit: Hz
	E.g. 400 Hz to 200 MHz (R&S SMW-B10)

**Example:** See [Example "To manage waveform files"](#) on page 1094.

**Manual operation:** See ["Clock Frequency"](#) on page 312

---

**[[:SOURce<hw>]:BB:ARbitrary:COUPled:STATE <State>**

In an instrument configuration with [Coupled sources](#), selects that all basebands use the same waveform.

**Parameters:**

<State>	1   ON   0   OFF
	*RST: 0

**Example:**

```

SCONfiguration:PRESet
SCONfiguration:MODE ADV
SCONfiguration:FADing SISO4X1X1
SCONfiguration:BASEband:SOURce COUP
SCONfiguration:APPLY

ENTity1:SOURcel:BB:ARbitrary:COUPled:STATE 0
ENTity1:SOURcel:BB:ARbitrary:WAVEform:SElect "/var/user/lte"
ENTity1:SOURce2:BB:ARbitrary:WAVEform:SElect "/var/user/lte"
ENTity1:SOURce3:BB:ARbitrary:WAVEform:SElect "/var/user/3gpp"
ENTity1:SOURce4:BB:ARbitrary:WAVEform:SElect "/var/user/gsm"
ENTity1:SOURce4:BB:ARbitrary:COUPled:TRIGger:DELay:OFFSet 100
SOURcel:BB:ARbitrary:STATE 1

```

**Manual operation:** See ["Use one Waveform for all basebands"](#) on page 311

---

**[[:SOURce<hw>]:BB:ARbitrary:COUPled:TRIGger:DELay:OFFSet <Offset>**

Sets a time delay to delay the waveform processing of a particular baseband.

**Parameters:**

<Offset> float  
 Range: 0 to 2147483647/clockrate  
 Increment: 250E-12  
 \*RST: 0

**Example:** See [:SOURce<hw>]:BB:ARbitrary:COUPled:STATE on page 1110.

**Manual operation:** See "Delay" on page 313

**[:SOURce<hw>]:BB:ARbitrary:WAVEform:CLOCK <Filename>, <Clock>**

Appends information on the ARB clock rate to the specified waveform file. This file must contain I/Q or marker data.

Use the following command to create the data:

:MMEMory:DATA:UNPRotected on page 912

**Parameters:**

<Filename> string  
 Complete file path and filename with file extension (\*.wav).  
 If the file is in the default directory, the file path can be omitted.

**Setting parameters:**

<Clock> float  
 Range: 400 to 100E6  
 Increment: 1E-3  
 \*RST: 1E6

**Example:** See :MMEMory:DATA:UNPRotected on page 912.

**Multi-segment commands****Required options**

See Section 5.10.1, "Required options", on page 360.

[:SOURce<hw>]:BB:ARbitrary:WSEGment?	1112
[:SOURce<hw>]:BB:ARbitrary:WSEGment:NAME?	1112
[:SOURce<hw>]:BB:ARbitrary:WSEGment:NEXT	1112
[:SOURce<hw>]:BB:ARbitrary:WSEGment:NEXT:EXECute	1112
[:SOURce<hw>]:BB:ARbitrary:WSEGment:NEXT:SOURce	1113
[:SOURce<hw>]:BB:ARbitrary:WSEGment:LMODE	1113
[:SOURce<hw>]:BB:ARbitrary:WSEGment:CONFigure:SEGMENT:CATalog?	1113
[:SOURce<hw>]:BB:ARbitrary:WSEGment:SEQuence:SElect	1113
[:SOURce<hw>]:BB:ARbitrary:WSEGment:SEQuence:APPend	1114
[:SOURce<hw>]:BB:ARbitrary:WSEGment:CREate	1114
[:SOURce<hw>]:BB:ARbitrary:WSEGment:CLOad	1115
[:SOURce<hw>]:BB:ARbitrary:WSEGment:CONFigure:MARKer:MODE	1115

<a href="#">[:SOURce&lt;hw&gt;]:BB:ARbitrary:WSEgment:CONFigure:MARKer:ESEgment.....</a>	1115
<a href="#">[:SOURce&lt;hw&gt;]:BB:ARbitrary:WSEgment:CONFigure:MARKer:FSEgment.....</a>	1115
<a href="#">[:SOURce&lt;hw&gt;]:BB:ARbitrary:TRIGger:SMODE.....</a>	1116

---

### **[:SOURce<hw>]:BB:ARbitrary:WSEgment?**

Queries the index of the currently processed segment.

**Return values:**

<WSegment>            integer  
                           Range:     0 to 1023  
                           \*RST:     0

**Example:**            see [Example "Configuring the output order of the segments"](#)  
                           on page 1097

**Usage:**                Query only

**Manual operation:** See ["Current Segment/Current Segment Index"](#) on page 380

---

### **[:SOURce<hw>]:BB:ARbitrary:WSEgment:NAME?**

Queries the name of the waveform of the currently output segment of the multi-segment waveform.

**Return values:**

<Name>                 string

**Example:**            See [Example "Configuring the output order of the segments"](#)  
                           on page 1097

**Usage:**                Query only

**Manual operation:** See ["Current Segment/Current Segment Index"](#) on page 380

---

### **[:SOURce<hw>]:BB:ARbitrary:WSEgment:NEXT <Next>**

Selects the segment to be output.

**Parameters:**

<Next>                 integer  
                           Range:     0 to 1023  
                           \*RST:     0

**Example:**            see [Example "Configuring the output order of the segments"](#)  
                           on page 1097

**Manual operation:** See ["Segment"](#) on page 380

---

### **[:SOURce<hw>]:BB:ARbitrary:WSEgment:NEXT:EXECute**

Triggers manually switchover to the subsequent segment in the multi-segment file.

This command is disabled, if a sequencing play list is enabled.



**Example:** See [Example "Configuring the output order of the segments"](#) on page 1097

**Usage:** Event

**Manual operation:** See ["Execute Next Segment"](#) on page 382

**[:SOURce<hw>]:BB:ARbitrary:WSEgment:NEXT:SOURce <Source>**

Selects the next segment source.

**Parameters:**

<Source> INTERNAL | NSEGM1 | INTERNAL | NSEGM1 | NSEGM2  
\*RST: INTERNAL

**Example:** See [Example "Configuring the output order of the segments"](#) on page 1097.

**Manual operation:** See ["Next Segment Source"](#) on page 381

**[:SOURce<hw>]:BB:ARbitrary:WSEgment:LMODe <LevelMode>**

Sets how the segments are leveled.

**Parameters:**

<LevelMode> HIGHEST | UNCHANGED  
\*RST: HIGHEST

**Example:** :SOURce1:BB:ARbitrary:WSEgment:LMODe HIGHEST

**Manual operation:** See ["Level Mode"](#) on page 381

**[:SOURce<hw>]:BB:ARbitrary:WSEgment:CONFigure:SEGMent:CATalog?**

Queries the segments of the currently selected configuration file.

**Return values:**

<Catalog> string

**Example:** See [Example "Creating a multi-segment waveform"](#) on page 1096.

**Usage:** Query only

**Manual operation:** See ["Segment Table"](#) on page 370

**[:SOURce<hw>]:BB:ARbitrary:WSEgment:SEQuence:SElect <Filename>**

Selects the sequencing list (files with extension \*.wvs)

**Parameters:**

<Filename> string

**Example:** see [Example "Using the ARB sequencer"](#) on page 1098

**Manual operation:** See ["New Sequencing List/Load Sequencing List"](#) on page 376  
 See ["Append"](#) on page 378  
 See ["Sequencing List"](#) on page 382

---

**[:SOURce<hw>]:BB:ARbitrary:WSEgment:SEquence:APPend <State>, <Segment>, <Count>, <Next>**

Appends a new segment to the selected sequencing play list.

**Setting parameters:**

**<State>** ON | OFF  
 Activates/deactivates the appended segment  
 \*RST: ON

**<Segment>** integer  
 Indicates the number of the segment as in the multi-segment waveform file  
 Range: 0 to SegmentCount - 1

**<Count>** integer  
 Defines how many times this segment is repeated  
 Range: 1 to 1048575

**<Next>** NEXT | BLANK | ENDLess | SEG0 | SEG1 | ... | SEG31 | 0...maxSegment  
 Determines the action after completing the current segment, like for instance which segment is processed after the processing of the current one is finished.

**Example:** See [Example "Using the ARB sequencer"](#) on page 1098

**Usage:** Setting only

**Manual operation:** See ["Append"](#) on page 378

---

**[:SOURce<hw>]:BB:ARbitrary:WSEgment:CREate <FilenameInput>**

Creates a multi-segment waveform (\*.wv) using the current settings of the specified *configuration file* (\*.inf\_mswv).

**Setting parameters:**

**<FilenameInput>** Complete file path, file name of the configuration file and file extension (\*.inf\_mswv)

**Example:** See [Example "Creating a multi-segment waveform"](#) on page 1096

**Usage:** Setting only

**Manual operation:** See ["Create Output File/Create and Load Output File"](#) on page 369

---

**[:SOURce<hw>]:BB:ARbitrary:WSEgment:CLOad <FilenameInput>**

Creates a multi-segment waveform using the current entries of the specified *configuration file* (\*.inf\_mswv).

The ARB generator is activated, the new multi-segment waveform (\*.wv) is loaded and the first segment is output in accordance to the trigger settings.

**Setting parameters:**

<FilenameInput>      string  
                                  Complete file path, file name of the configuration file and file extension (\*.inf\_mswv)

**Example:**                See [Example "Creating a multi-segment waveform"](#) on page 1096

**Usage:**                 Setting only

**Manual operation:**    See ["Create Output File/Create and Load Output File"](#) on page 369

---

**[:SOURce<hw>]:BB:ARbitrary:WSEgment:CONFigure:MARKer:MODE <Mode>**

Defines the way the marker information within the separate segments is processed.

**Parameters:**

<Mode>                    IGNore | TAKE  
                                  \*RST:        TAKE

**Example:**                see [Example "Adding extra marker signals"](#) on page 1099

**Manual operation:**    See ["Segment Marker"](#) on page 374

---

**[:SOURce<hw>]:BB:ARbitrary:WSEgment:CONFigure:MARKer:ESEgment <Mode>**

**[:SOURce<hw>]:BB:ARbitrary:WSEgment:CONFigure:MARKer:FSEgment <Mode>**

Enables/disables the generation of an additional marker restart signal at the beginning of the first segment (FSEgment) or at the beginning of each segment (ESEgment).

If additional marker generation is enabled, the existing marker signals in the individual segment waveform files are not considered.

**Parameters:**

<Mode>                    OFF | MRK1 | MRK2 | MRK3 | MRK4  
                                  \*RST:        OFF

**Example:**                see [Example "Adding extra marker signals"](#) on page 1099

**Manual operation:**    See ["Sequence Restart"](#) on page 374

---

**[:SOURce<hw>]:BB:ARbitrary:TRIGger:SMODE <SMode>**

Selects the extended trigger mode for multi segment waveforms.

**Parameters:**

<SMode>            SAME | NEXT | SEQuencer | NSEam  
                      NSEam = Next Segment Seamless  
                      \*RST:        NEXT

**Example:**        See [Example "Configuring the output order of the segments"](#) on page 1097.

**Manual operation:** See ["Next Segment Mode"](#) on page 380

### Multi-segment sequencing commands

#### Required options

See [Section 5.10.1, "Required options"](#), on page 360.

<a href="#">[:SOURce&lt;hw&gt;]:BB:ARbitrary:WSEGment:CONFigure:BLANk:APPend</a> .....	1116
<a href="#">[:SOURce&lt;hw&gt;]:BB:ARbitrary:WSEGment:CONFigure:CATalog?</a> .....	1117
<a href="#">[:SOURce&lt;hw&gt;]:BB:ARbitrary:WSEGment:CONFigure:CLOCK</a> .....	1117
<a href="#">[:SOURce&lt;hw&gt;]:BB:ARbitrary:WSEGment:CONFigure:CLOCK:MODE</a> .....	1117
<a href="#">[:SOURce&lt;hw&gt;]:BB:ARbitrary:WSEGment:CONFigure:LEVel[:MODE]</a> .....	1118
<a href="#">[:SOURce&lt;hw&gt;]:BB:ARbitrary:WSEGment:CONFigure:COMMENT</a> .....	1118
<a href="#">[:SOURce&lt;hw&gt;]:BB:ARbitrary:WSEGment:CONFigure:DELeTe</a> .....	1118
<a href="#">[:SOURce&lt;hw&gt;]:BB:ARbitrary:WSEGment:CONFigure:OFILe</a> .....	1118
<a href="#">[:SOURce&lt;hw&gt;]:BB:ARbitrary:WSEGment:CONFigure:SEGMENT:APPend</a> .....	1119
<a href="#">[:SOURce&lt;hw&gt;]:BB:ARbitrary:WSEGment:CONFigure:SEGMENT:INDex&lt;ch0&gt;:DELeTe</a> .....	1119
<a href="#">[:SOURce&lt;hw&gt;]:BB:ARbitrary:WSEGment:CONFigure:SEGMENT:INDex&lt;ch0&gt;:DOWN</a> .....	1119
<a href="#">[:SOURce&lt;hw&gt;]:BB:ARbitrary:WSEGment:CONFigure:SEGMENT:INDex&lt;ch0&gt;:UP</a> .....	1119
<a href="#">[:SOURce&lt;hw&gt;]:BB:ARbitrary:WSEGment:CONFigure:SELeCt</a> .....	1120

---

**[:SOURce<hw>]:BB:ARbitrary:WSEGment:CONFigure:BLANk:APPend**  
                      <SampCount>, <Frequency>

Adds a blank segment to the multi-segment file.

**Setting parameters:**

<SampCount>        float  
                      Specifies the number of samples.  
                      Range:        512 to 1E7  
                      Increment:    1  
                      \*RST:        1000

<Frequency>        float  
                      Determines the clock rate.  
                      Range:        400 Hz to depends on the installed options  
                      Increment:    0.001  
                      \*RST:        1E8

- Example:** See [Example "Creating a multi-segment waveform"](#) on page 1096
- Usage:** Setting only
- Manual operation:** See ["Clock Rate"](#) on page 372  
See ["Samples"](#) on page 372  
See ["Period"](#) on page 372  
See ["Append Blank"](#) on page 372

#### **[ :SOURce<hw>]:BB:ARbitrary:WSEgment:CONFigure:CATalog?**

Queries the available configuration files in the default directory. See also [Section 5.10.2.3, "File concept"](#), on page 362.

**Return values:**

<Catalog> string

**Example:** see [Example "Creating a multi-segment waveform"](#) on page 1096

**Usage:** Query only

**Manual operation:** See ["Load List"](#) on page 368

#### **[ :SOURce<hw>]:BB:ARbitrary:WSEgment:CONFigure:CLOCK <Clock>**

Defines the clock rate used for multi-segment waveform output, if the clock mode is USER.

**Parameters:**

<Clock> float  
Increment: 1E-3  
\*RST: maximum sample rate

**Example:** See [Example "Creating a multi-segment waveform"](#) on page 1096

**Manual operation:** See ["User Clock Rate"](#) on page 374

#### **[ :SOURce<hw>]:BB:ARbitrary:WSEgment:CONFigure:CLOCK:MODE <Mode>**

Selects the clock rate mode for the multi segment waveform. Use the command [\[ :SOURce<hw>\]:BB:ARbitrary:WSEgment:CONFigure:CLOCK](#) to define the clock in clock mode user.

**Parameters:**

<Mode> UNCHanged | HIGHest | USER  
\*RST: UNCHanged

**Example:** See [Example "Creating a multi-segment waveform"](#) on page 1096.

**Manual operation:** See ["Clock"](#) on page 373

---

**[[:SOURce<hw>]:BB:ARbitrary:WSEgment:CONFigure:LEVel[:MODE] <Mode>**

Selects the level mode, unchanged or equal RMS, for the multi-segment waveform.

**Parameters:**

<Mode> UNCHanged | ERMS  
\*RST: UNCHanged

**Example:** See [Example "Creating a multi-segment waveform"](#) on page 1096.

**Manual operation:** See ["Level"](#) on page 373

---

**[[:SOURce<hw>]:BB:ARbitrary:WSEgment:CONFigure:COMment <Comment>**

Enters a comment for the selected configuration file.

**Parameters:**

<Comment> string

**Example:** See [Example "Creating a multi-segment waveform"](#) on page 1096

**Manual operation:** See ["Comment"](#) on page 368

---

**[[:SOURce<hw>]:BB:ARbitrary:WSEgment:CONFigure:DELeTe <Filename>**

Deletes the selected configuration file.

**Setting parameters:**

<Filename> string

**Example:** See [Example "Creating a multi-segment waveform"](#) on page 1096.

**Usage:** Setting only

**Manual operation:** See ["Load List"](#) on page 368

---

**[[:SOURce<hw>]:BB:ARbitrary:WSEgment:CONFigure:OFILe <OFile>**

Defines the file name of the output multi-segment waveform.

**Parameters:**

<OFile> string

**Example:** See [Example "Creating a multi-segment waveform"](#) on page 1096

**Manual operation:** See ["Output File"](#) on page 368  
See ["Create Output File/Create and Load Output File"](#) on page 369

---

**[:SOURce<hw>]:BB:ARBitrary:WSEgment:CONFigure:SEGment:APPend**  
 <Waveform>

Appends the specified waveform to the configuration file.

**Setting parameters:**

<Waveform>            string

**Example:**            see [Example "Creating a multi-segment waveform"](#)  
 on page 1096

**Usage:**              Setting only

**Manual operation:** See ["Append"](#) on page 371

---

**[:SOURce<hw>]:BB:ARBitrary:WSEgment:CONFigure:SEGment:INDex<ch0>:  
 DELete**

Deletes the selected waveform segment in the segment table.

**Suffix:**

INDex<ch0>            0 to depends on settings  
 Waveform segment number

**Example:**            See [Example "Creating a multi-segment waveform"](#)  
 on page 1096.

**Usage:**              Event

**Manual operation:** See ["Delete"](#) on page 371

---

**[:SOURce<hw>]:BB:ARBitrary:WSEgment:CONFigure:SEGment:INDex<ch0>:  
 DOWN**

Shifts the selected waveform segment down by one segment in the segment table.

**Suffix:**

INDex<ch0>            0 to depends on settings  
 Waveform segment number

**Example:**            See [Example "Creating a multi-segment waveform"](#)  
 on page 1096.

**Usage:**              Event

**Manual operation:** See ["Shift Segment Down"](#) on page 371

---

**[:SOURce<hw>]:BB:ARBitrary:WSEgment:CONFigure:SEGment:INDex<ch0>:UP**

Shifts the selected waveform segment up by one segment in the segment table.

**Suffix:**

INDex<ch0>            0 to depends on settings  
 Waveform segment number

**Example:** See [Example "Creating a multi-segment waveform"](#) on page 1096.

**Usage:** Event

**Manual operation:** See ["Shift Segment Up"](#) on page 371

**[:SOURce<hw>]:BB:ARBitrary:WSEgment:CONFigure:SELEct <Filename>**

Selects a configuration file from the default directory. If a configuration file with the specified name does not yet exist, it is created. The file extension `*.inf_mswv` may be omitted.

**Parameters:**

<Filename> string

**Example:** see [Example "Creating a multi-segment waveform"](#) on page 1096

**Manual operation:** See ["New List"](#) on page 368  
See ["Load List"](#) on page 368

## Multicarrier commands

### Required options

See [Section 5.11.1, "Required options"](#), on page 391.

### Common suffixes

Suffix	Value range
CARRier<ch>	1 to 512

<a href="#">[:SOURce&lt;hw&gt;]:BB:ARBitrary:MCARrier:PRESet</a> .....	1121
<a href="#">[:SOURce&lt;hw&gt;]:BB:ARBitrary:MCARrier:SETTing:CATalog?</a> .....	1121
<a href="#">[:SOURce&lt;hw&gt;]:BB:ARBitrary:MCARrier:SETTing:LOAD</a> .....	1121
<a href="#">[:SOURce&lt;hw&gt;]:BB:ARBitrary:MCARrier:SETTing:STORE</a> .....	1122
<a href="#">[:SOURce&lt;hw&gt;]:BB:ARBitrary:MCARrier:CARRier:COUNT</a> .....	1122
<a href="#">[:SOURce&lt;hw&gt;]:BB:ARBitrary:MCARrier:CARRier:MODE</a> .....	1122
<a href="#">[:SOURce&lt;hw&gt;]:BB:ARBitrary:MCARrier:CARRier:SPACing</a> .....	1122
<a href="#">[:SOURce&lt;hw&gt;]:BB:ARBitrary:MCARrier:SAMPles?</a> .....	1123
<a href="#">[:SOURce&lt;hw&gt;]:BB:ARBitrary:MCARrier:TIME</a> .....	1123
<a href="#">[:SOURce&lt;hw&gt;]:BB:ARBitrary:MCARrier:CFACTor:MODE</a> .....	1123
<a href="#">[:SOURce&lt;hw&gt;]:BB:ARBitrary:MCARrier:CLIPping:CFACTor</a> .....	1124
<a href="#">[:SOURce&lt;hw&gt;]:BB:ARBitrary:MCARrier:CLIPping:CUToff</a> .....	1124
<a href="#">[:SOURce&lt;hw&gt;]:BB:ARBitrary:MCARrier:CLIPping:STATe]</a> .....	1124
<a href="#">[:SOURce&lt;hw&gt;]:BB:ARBitrary:MCARrier:TIME:MODE</a> .....	1125
<a href="#">[:SOURce&lt;hw&gt;]:BB:ARBitrary:MCARrier:POWer:REFerence</a> .....	1125
<a href="#">[:SOURce&lt;hw&gt;]:BB:ARBitrary:MCARrier:OFILe</a> .....	1125
<a href="#">[:SOURce&lt;hw&gt;]:BB:ARBitrary:MCARrier:CLOad</a> .....	1125
<a href="#">[:SOURce&lt;hw&gt;]:BB:ARBitrary:MCARrier:CLOCK?</a> .....	1126



<code>[:SOURce&lt;hw&gt;]:BB:ARBitrary:MCARrier:CREate</code> .....	1126
<code>[:SOURce&lt;hw&gt;]:BB:ARBitrary:MCARrier:CARRier&lt;ch&gt;:STATe</code> .....	1126
<code>[:SOURce&lt;hw&gt;]:BB:ARBitrary:MCARrier:CARRier&lt;ch&gt;:FREQuency</code> .....	1127
<code>[:SOURce&lt;hw&gt;]:BB:ARBitrary:MCARrier:CARRier&lt;ch&gt;:PHASe</code> .....	1127
<code>[:SOURce&lt;hw&gt;]:BB:ARBitrary:MCARrier:CARRier&lt;ch&gt;:POWer</code> .....	1127
<code>[:SOURce&lt;hw&gt;]:BB:ARBitrary:MCARrier:CARRier&lt;ch&gt;:DELay</code> .....	1128
<code>[:SOURce&lt;hw&gt;]:BB:ARBitrary:MCARrier:CARRier&lt;ch&gt;:FILE</code> .....	1128
<code>[:SOURce&lt;hw&gt;]:BB:ARBitrary:MCARrier:CARRier&lt;ch&gt;:CONFLict?</code> .....	1128
<code>[:SOURce&lt;hw&gt;]:BB:ARBitrary:MCARrier:EDIT:CARRier:STATe</code> .....	1128
<code>[:SOURce&lt;hw&gt;]:BB:ARBitrary:MCARrier:EDIT:CARRier:STARt</code> .....	1129
<code>[:SOURce&lt;hw&gt;]:BB:ARBitrary:MCARrier:EDIT:CARRier:STOP</code> .....	1129
<code>[:SOURce&lt;hw&gt;]:BB:ARBitrary:MCARrier:EDIT:CARRier:POWer:STEP</code> .....	1129
<code>[:SOURce&lt;hw&gt;]:BB:ARBitrary:MCARrier:EDIT:CARRier:POWer[:STARt]</code> .....	1129
<code>[:SOURce&lt;hw&gt;]:BB:ARBitrary:MCARrier:EDIT:CARRier:PHASe:STEP</code> .....	1130
<code>[:SOURce&lt;hw&gt;]:BB:ARBitrary:MCARrier:EDIT:CARRier:PHASe[:STARt]</code> .....	1130
<code>[:SOURce&lt;hw&gt;]:BB:ARBitrary:MCARrier:EDIT:CARRier:DELay:STEP</code> .....	1130
<code>[:SOURce&lt;hw&gt;]:BB:ARBitrary:MCARrier:EDIT:CARRier:DELay[:STARt]</code> .....	1131
<code>[:SOURce&lt;hw&gt;]:BB:ARBitrary:MCARrier:EDIT:CARRier:FILE</code> .....	1131
<code>[:SOURce&lt;hw&gt;]:BB:ARBitrary:MCARrier:EDIT:CARRier:EXECute</code> .....	1131

---

#### `[:SOURce<hw>]:BB:ARBitrary:MCARrier:PRESet`

Sets all the multicarrier parameters to their default values.

**Example:** See [Example "To generate a multicarrier signal"](#) on page 1100.

**Usage:** Event

**Manual operation:** See ["Set to Default"](#) on page 395

---

#### `[:SOURce<hw>]:BB:ARBitrary:MCARrier:SETTing:CATalog?`

Queries the files with settings in the default directory. Listed are files with the file extension `*.arb_multcarr`.

**Return values:**

<Catalog> string

**Example:** See [Example "To generate a multicarrier signal"](#) on page 1100.

**Usage:** Query only

**Manual operation:** See ["Save/Recall"](#) on page 395

---

#### `[:SOURce<hw>]:BB:ARBitrary:MCARrier:SETTing:LOAD <Filename>`

Loads the selected file from the default or the specified directory. Loaded are files with extension `*.arb_multcarr`.

**Setting parameters:**

<Filename> "<filename>"

Filename or complete file path; file extension can be omitted.

**Example:** See [Example "To generate a multicarrier signal"](#) on page 1100.

**Usage:** Setting only

**Manual operation:** See ["Save/Recall"](#) on page 395

**[ :SOURce<hw>]:BB:ARbitrary:MCARrier:SETTING:STORe <Filename>**

Saves the current settings into the selected file; the file extension (`*.arb_multcarr`) is assigned automatically.

**Setting parameters:**

<Filename> string  
Filename or complete file path

**Example:** See [Example "To generate a multicarrier signal"](#) on page 1100.

**Usage:** Setting only

**Manual operation:** See ["Save/Recall"](#) on page 395

**[ :SOURce<hw>]:BB:ARbitrary:MCARrier:CARRier:COUNT <Count>**

Sets the number of carriers in the ARB multicarrier waveform.

**Parameters:**

<Count> integer  
Range: 1 to 512  
\*RST: 1

**Example:** See [Example "To generate a multicarrier signal"](#) on page 1100.

**Manual operation:** See ["Number of Carriers"](#) on page 395  
See ["Number of Carriers"](#) on page 402

**[ :SOURce<hw>]:BB:ARbitrary:MCARrier:CARRier:MODE <Mode>**

Sets the carrier frequency mode for the single carriers.

**Parameters:**

<Mode> EQUidistant | ARbitrary  
\*RST: EQUidistant

**Example:** `BB:ARB:MCAR:CARR:MODE EQU`  
Sets an equidistant carrier spacing. The carrier frequency cannot be set.

**Manual operation:** See ["Mode"](#) on page 395

**[ :SOURce<hw>]:BB:ARbitrary:MCARrier:CARRier:SPACing <Spacing>**

Sets the frequency spacing between adjacent carriers of the multicarrier waveform.

See also [Section 5.11.2.1, "Defining the carrier frequency"](#), on page 392.

**Parameters:**

<Spacing> float  
 Range: 0.0 to depends on the installed options, for example 120E6 (R&S SMW-B10)  
 Increment: 0.01  
 \*RST: 0  
 Default unit: Hz

**Example:** See [Example "To generate a multicarrier signal"](#) on page 1100.

**Manual operation:** See ["Carrier Spacing"](#) on page 396

**[:SOURce<hw>]:BB:ARbitrary:MCARrier:SAMPles?**

Queries the resulting file size.

**Return values:**

<Samples> integer  
 Range: 0 to INT\_MAX  
 \*RST: 0  
 Default unit: samples

**Example:** SOURce1:BB:ARbitrary:MCARrier:SAMPles?  
 Queries the file size of the currently calculated multi-carrier waveform.

**Usage:** Query only

**Manual operation:** See ["File Size"](#) on page 401

**[:SOURce<hw>]:BB:ARbitrary:MCARrier:TIME <Time>**

Sets the user-defined signal period.

**Parameters:**

<Time> float  
 Range: 0 to 1E9  
 Increment: 1E-9  
 \*RST: 0  
 Default unit: s

**Example:** SOURce1:BB:ARbitrary:MCARrier:MODE USER  
 Selects signal period mode user.  
 SOURce1:BB:ARbitrary:MCARrier:TIME 10  
 Sets a signal period of 10 seconds

**Manual operation:** See ["Signal Period Mode"](#) on page 397

**[:SOURce<hw>]:BB:ARbitrary:MCARrier:CFACTOR:MODE <Mode>**

Sets the mode for optimizing the crest factor by calculating the carrier phases.

**Parameters:**

<Mode> OFF | MIN | MAX  
 \*RST: OFF

**Example:**

SOURce1:BB:ARbitrary:MCARrier:CFACTOR:MODE OFF  
 Switches off automatic crest factor optimization.

**Manual operation:** See "[Crest Factor Mode](#)" on page 396

**[:SOURce<hw>]:BB:ARbitrary:MCARrier:CLIPping:CFACTOR <CFactor>**

Sets the value of the desired crest factor, if baseband clipping is enabled.

A target crest factor above the crest factor of the unclipped multicarrier signal has no effect.

**Parameters:**

<CFactor> float  
 Range: -50 to 50  
 Increment: 0.01  
 \*RST: 50  
 Default unit: dB

**Example:**

See [\[:SOURce<hw>\]:BB:ARbitrary:MCARrier:CLIPping\[:STATe\]](#) on page 1124.

**Manual operation:** See "[Target Crest Factor](#)" on page 396

**[:SOURce<hw>]:BB:ARbitrary:MCARrier:CLIPping:CUTOFF <Cutoff>**

Sets the cutoff frequency of the final low pass filter, if baseband clipping is enabled.

**Parameters:**

<Cutoff> float  
 Range: 0 to 50E6  
 Increment: 0.01  
 \*RST: 50E6

**Example:**

See [\[:SOURce<hw>\]:BB:ARbitrary:MCARrier:CLIPping\[:STATe\]](#) on page 1124.

**Manual operation:** See "[Filter Cut Off Frequency](#)" on page 397

**[:SOURce<hw>]:BB:ARbitrary:MCARrier:CLIPping[:STATe] <State>**

Switches baseband clipping on and off.

**Parameters:**

<State> 1 | ON | 0 | OFF  
 \*RST: 0

**Example:**

```
SOURce1:BB:ARbitrary:MCARrier:CLIPPING:STATE ON
SOURce1:BB:ARbitrary:MCARrier:CLIPPING:CFACTOR 37
SOURce1:BB:ARbitrary:MCARrier:CLIPPING:CUTOFF 50
```

**Manual operation:** See ["Clipping"](#) on page 396

#### **[ :SOURce<hw>]:BB:ARbitrary:MCARrier:TIME:MODE <Mode>**

Selects the mode for calculating the resulting signal period of the multi-carrier waveform. The resulting period is always calculated for all carriers in the carrier table irrespective of their state (ON/OFF).

**Parameters:**

<Mode> USER | LONG | SHORT | LCM  
\*RST: LONG

**Example:** BB:ARB:MCAR:TIME:MODE LONG  
The resulting signal period is defined by the longest I/Q file in the carrier table. Shorter I/Q files are periodically repeated.

**Manual operation:** See ["Signal Period Mode"](#) on page 397

#### **[ :SOURce<hw>]:BB:ARbitrary:MCARrier:POWER:REFERENCE <Reference>**

Defines the way the individual carriers in a composed multi carrier signal are leveled.

**Parameters:**

<Reference> RMS | PEAK  
\*RST: RMS

**Manual operation:** See ["Power Reference"](#) on page 398

#### **[ :SOURce<hw>]:BB:ARbitrary:MCARrier:OFILE <OFile>**

Sets the output filename for the multicarrier waveform (file extension \*.wv).

This filename is required to calculate the waveform with the commands [ :SOURce<hw>]:BB:ARbitrary:MCARrier:CLOAD or [ :SOURce<hw>]:BB:ARbitrary:MCARrier:CREATE.

**Parameters:**

<OFile> string

**Example:** See [Example "To generate a multicarrier signal"](#) on page 1100.

**Manual operation:** See ["Output File"](#) on page 400

#### **[ :SOURce<hw>]:BB:ARbitrary:MCARrier:CLOAD**

Creates a multicarrier waveform using the current entries of the carrier table and enables the ARB.

Use the command `[ :SOURce<hw> ] :BB:ARbitrary:MCARrier:OFILe` to define the multicarrier waveform filename. The file extension is `*.wv`.

**Example:** See [Example "To generate a multicarrier signal"](#) on page 1100.

**Usage:** Event

**Manual operation:** See ["Create/Create and Load"](#) on page 399

#### `[ :SOURce<hw> ] :BB:ARbitrary:MCARrier:CLOCK?`

Queries the resulting sample rate at which the multi-carrier waveform is output by the arbitrary waveform generator. The output clock rate depends on the number of carriers, carrier spacing, and input sample rate of the leftmost or rightmost carriers.

**Return values:**

<Clock> float  
 Range: 400 to Max  
 Increment: 1E-3

**Example:** `BB:ARB:MCAR:CLOC?`  
 Queries the ARB multi-carrier output clock rate.

**Usage:** Query only

**Manual operation:** See ["Clock Rate"](#) on page 400

#### `[ :SOURce<hw> ] :BB:ARbitrary:MCARrier:CREate`

Creates a multicarrier waveform using the current settings of the carrier table.

Use the command `[ :SOURce<hw> ] :BB:ARbitrary:MCARrier:OFILe` to define the multicarrier waveform filename. The file extension is `*.wv`.

**Example:** See [Example "To generate a multicarrier signal"](#) on page 1100.

**Usage:** Event

**Manual operation:** See ["Create/Create and Load"](#) on page 399

#### `[ :SOURce<hw> ] :BB:ARbitrary:MCARrier:CARRier<ch>:STATe <State>`

Enables the selected single carrier of the multicarrier signal.

**Parameters:**

<State> 1 | ON | 0 | OFF  
 \*RST: 0

**Example:** See [Example "To generate a multicarrier signal"](#) on page 1100.

**Manual operation:** See ["State"](#) on page 402

---

**[:SOURce<hw>]:BB:ARbitrary:MCARrier:CARRier<ch>:FREQuency <Frequency>**

Sets or indicates the carrier frequency, depending on the selected carrier frequency mode.

**Parameters:**

<Frequency>            integer  
                                  Range:        depends on the installed options  
                                  \*RST:        0  
                                  E.g. -60 MHz to +60 MHz (R&S SMW-B10)

**Example:**            SOURce1:BB:ARbitrary:MCARrier:CARRier:MODE ARB  
                                  SOURce1:BB:ARbitrary:MCARrier:CARRier1:  
                                  FREQuency 5.0  
                                  Sets 5.0 MHz carrier frequency.

**Manual operation:**    See "[Carrier Freq. Offs. \(MHz\)](#)" on page 402

---

**[:SOURce<hw>]:BB:ARbitrary:MCARrier:CARRier<ch>:PHASe <Phase>**

Sets the start phase of the selected carrier.

**Parameters:**

<Phase>                 float  
                                  Range:        0 to 359.99  
                                  Increment: 0.01  
                                  \*RST:        0  
                                  Default unit: DEG

**Example:**            SOURce1:BB:ARbitrary:MCARrier:CARRier19:PHASe  
                                  90  
                                  Sets a start phase.

**Manual operation:**    See "[Phase \(deg\)](#)" on page 402

---

**[:SOURce<hw>]:BB:ARbitrary:MCARrier:CARRier<ch>:POWER <Power>**

Sets the gain of the selected carrier.

**Parameters:**

<Power>                 float  
                                  Range:        -80 to 0  
                                  Increment: 0.01  
                                  \*RST:        0  
                                  Default unit: dB

**Example:**            SOURce1:BB:ARbitrary:MCARrier:CARRier15:POWER  
                                  -50  
                                  Sets the power of carrier 15 to -50 dB.

**Manual operation:**    See "[Gain \(dB\)](#)" on page 402

---

**[[:SOURce<hw>]:BB:ARbitrary:MCARrier:CARRier<ch>:DELay <Delay>**

Sets the start delay of the selected carrier.

**Parameters:**

<Delay> float  
 Range: 0 to 1  
 Increment: 1E-9  
 \*RST: 0  
 Default unit: s

**Example:** BB:ARB:MCAR:CARR15:DEL 5us  
 sets a start delay of 50 us for carrier 15.

**Manual operation:** See ["Delay \(ns\)"](#) on page 402

---

**[[:SOURce<hw>]:BB:ARbitrary:MCARrier:CARRier<ch>:FILE <File>**

Selects the I/Q data file that contains the I/Q samples for modulation onto the selected single carrier.

**Parameters:**

<File> <file name>

**Example:** See [Example "To generate a multicarrier signal"](#) on page 1100.

**Manual operation:** See ["File"](#) on page 402

---

**[[:SOURce<hw>]:BB:ARbitrary:MCARrier:CARRier<ch>:CONFLICT?**

Queries carrier conflicts. A conflict arises when the carriers overlap.

**Return values:**

<Conflict> 1 | ON | 0 | OFF  
**0**  
 No conflict  
 \*RST: 0

**Example:** BB:ARB:MCAR:CARR:CONF?

**Usage:** Query only

**Manual operation:** See ["!!!"](#) on page 403

---

**[[:SOURce<hw>]:BB:ARbitrary:MCARrier:EDIT:CARRier:STATE <State>**

Switches all the carriers in the selected carrier range on or off.

**Parameters:**

<State> 1 | ON | 0 | OFF  
 \*RST: 1

**Example:** BB:ARB:MCAR:EDIT:CARR:STAT ON  
 Sets all the carriers in the carrier range to ON.



**Manual operation:** See ["Carrier State"](#) on page 404

---

```
[ :SOURce<hw>]:BB:ARBitrary:MCARrier:EDIT:CARRier:START <Start>
[:SOURce<hw>]:BB:ARBitrary:MCARrier:EDIT:CARRier:STOP <Stop>
```

Selects the last carrier in the carrier range to which the settings shall apply.

**Parameters:**

```
<Stop>          integer
                Range:    0 to 511
                *RST:     0
```

**Example:** `BB:ARB:MCAR:EDIT:CARR:STOP 4`  
The carrier range stops at carrier 4.

**Manual operation:** See ["Carrier Start"](#) on page 404  
See ["Carrier Stop"](#) on page 404

---

```
[ :SOURce<hw>]:BB:ARBitrary:MCARrier:EDIT:CARRier:POWER:STEP <Step>
```

Sets the step width by which the starting power of the carriers in the defined carrier range is incremented.

**Parameters:**

```
<Step>          float
                Range:    -80 to 80
                Increment: 0.01
                *RST:     0
                Default unit: dB
```

**Example:** `BB:ARB:MCAR:EDIT:CARR:POW -80dB`  
Sets a power of -80 dB for the carriers in the carrier range.  
`BB:ARB:MCAR:EDIT:CARR:POW:STEP 1 dB`  
The power is incremented by 1dB for each carrier.  
That is, the first carrier has -80 dB, the second -79 dB, and so on.

**Manual operation:** See ["Gain Step"](#) on page 404

---

```
[ :SOURce<hw>]:BB:ARBitrary:MCARrier:EDIT:CARRier:POWER[:START] <Start>
```

Sets the power for the individual carriers in the defined carrier range.

**Parameters:**

```
<Start>         float
                Range:    -80 to 0
                Increment: 0.01
                *RST:     0
                Default unit: dB
```

**Example:** `BB:ARB:MCAR:EDIT:CARR:POW -50 dB`  
sets the power of the carriers in the carrier range to -50 dB.

**Manual operation:** See ["Gain Start"](#) on page 404

---

**[[:SOURce<hw>]:BB:ARbitrary:MCARrier:EDIT:CARRier:PHASe:STEP <Step>**

Sets the step width by which the start phases of the carriers in the defined carrier range is incremented.

**Parameters:**

<Step> float  
 Range: -359.99 to 359.99  
 Increment: 0.01  
 \*RST: 0  
 Default unit: DEG

**Example:**

BB:ARB:MCAR:EDIT:CARR:PHAS 90 DEG

Sets a start phase of 90° for the carriers in the carrier range.

BB:ARB:MCAR:EDIT:CARR:PHAS:STEP 1 DEG

The start phase is incremented by 1° for each carrier. That is, the first carrier has a start phase of 90°, the second a start phase of 91°, and so on.

**Manual operation:** See ["Phase Step"](#) on page 404

---

**[[:SOURce<hw>]:BB:ARbitrary:MCARrier:EDIT:CARRier:PHASe[:START] <Start>**

Sets the start phase for the individual carriers in the defined carrier range.

**Parameters:**

<Start> float  
 Range: 0 to 359.99  
 Increment: 0.01  
 \*RST: 0  
 Default unit: DEG

**Example:**

BB:ARB:MCAR:EDIT:CARR:PHAS 90 DEG

sets a start phase of 90° for the carriers in the carrier range.

**Manual operation:** See ["Phase Start"](#) on page 404

---

**[[:SOURce<hw>]:BB:ARbitrary:MCARrier:EDIT:CARRier:DELay:STEP <Step>**

Sets the step width by which the start delays of the carriers in the defined carrier range is incremented.

**Parameters:**

<Step> float  
 Range: -1 to 1  
 Increment: 1E-9  
 \*RST: 0  
 Default unit: s

**Example:** `BB:ARB:MCAR:EDIT:CARR:DEL 5 us`  
 Sets a start delay of 5 us for the carriers in the carrier range.  
`BB:ARB:MCAR:EDIT:CARR:DEL:STEP 1 us`  
 The start delay is incremented by 1us for each carrier. That is, the first carrier has a start delay of 5 us, the second a start delay of 6 us, and so on.

**Manual operation:** See "[Delay Step](#)" on page 405

**[:SOURCE<hw>]:BB:ARbitrary:MCARrier:EDIT:CARRier:DELay[:START] <Start>**

Sets the start delay for the individual carriers in the defined carrier range.

**Parameters:**

<Start> float  
 Range: 0 to 1  
 Increment: 1E-9  
 \*RST: 0  
 Default unit: s

**Example:** `BB:ARB:MCAR:EDIT:CARR:DEL 5us`  
 Sets a start delay of 5 us for the carriers in the carrier range.

**Manual operation:** See "[Delay Start](#)" on page 405

**[:SOURCE<hw>]:BB:ARbitrary:MCARrier:EDIT:CARRier:FILE <File>**

Selects the input file. The data of the file are modulated onto the carriers in the defined carrier range.

**Parameters:**

<File> string

**Example:** `BB:ARB:MCAR:EDIT:CARR:FILE`  
`"/var/user/temp/IQ_wcdma"`  
 selects input file IQ\_wcdma.

**Manual operation:** See "[Input Waveform File](#)" on page 405

**[:SOURCE<hw>]:BB:ARbitrary:MCARrier:EDIT:CARRier:EXECute**

Adopts the settings for the selected carrier range.

**Example:** `BB:ARB:MCAR:EDIT:CARR:STAR 4`  
`BB:ARB:MCAR:EDIT:CARR:STOP 20`  
`BB:ARB:MCAR:EDIT:CARR:STAT ON`  
`BB:ARB:MCAR:EDIT:CARR:EXEC`

**Usage:** Event

**Manual operation:** See "[Apply Assistant Settings](#)" on page 405

**Notch filter commands**

Option: R&S SMW-K811.

See also [Section 5.8.1, "Required options"](#), on page 353.

<code>[[:SOURce&lt;hw&gt;]:BB:DVB:NOTCh</code> .....	1132
<code>[[:SOURce&lt;hw&gt;]:BB:EUTRa:NOTCh</code> .....	1132
<code>[[:SOURce&lt;hw&gt;]:BB:OFDM:NOTCh</code> .....	1132
<code>[[:SOURce&lt;hw&gt;]:BB:ONEWeb:NOTCh</code> .....	1133
<code>[[:SOURce&lt;hw&gt;]:BB:ARbitrary:NOTCh</code> .....	1133
<code>[[:SOURce&lt;hw&gt;]:BB:DVB:NOTCh:CLOCK?</code> .....	1133
<code>[[:SOURce&lt;hw&gt;]:BB:EUTRa:NOTCh:CLOCK?</code> .....	1133
<code>[[:SOURce&lt;hw&gt;]:BB:OFDM:NOTCh:CLOCK?</code> .....	1133
<code>[[:SOURce&lt;hw&gt;]:BB:ONEWeb:NOTCh:CLOCK?</code> .....	1133
<code>[[:SOURce&lt;hw&gt;]:BB:ARbitrary:NOTCh:CLOCK?</code> .....	1133
<code>[[:SOURce&lt;hw&gt;]:BB:DVB:NOTCh:COUNT</code> .....	1133
<code>[[:SOURce&lt;hw&gt;]:BB:EUTRa:NOTCh:COUNT</code> .....	1133
<code>[[:SOURce&lt;hw&gt;]:BB:OFDM:NOTCh:COUNT</code> .....	1133
<code>[[:SOURce&lt;hw&gt;]:BB:ONEWeb:NOTCh:COUNT</code> .....	1133
<code>[[:SOURce&lt;hw&gt;]:BB:ARbitrary:NOTCh:COUNT</code> .....	1133
<code>[[:SOURce&lt;hw&gt;]:BB:DVB:NOTCh&lt;ch&gt;:STATE</code> .....	1133
<code>[[:SOURce&lt;hw&gt;]:BB:EUTRa:NOTCh&lt;ch&gt;:STATE</code> .....	1133
<code>[[:SOURce&lt;hw&gt;]:BB:OFDM:NOTCh&lt;ch&gt;:STATE</code> .....	1133
<code>[[:SOURce&lt;hw&gt;]:BB:ONEWeb:NOTCh&lt;ch&gt;:STATE</code> .....	1134
<code>[[:SOURce&lt;hw&gt;]:BB:ARbitrary:NOTCh&lt;ch&gt;:STATE</code> .....	1134
<code>[[:SOURce&lt;hw&gt;]:BB:DVB:NOTCh&lt;ch&gt;:FREQUENCY:OFFSet</code> .....	1134
<code>[[:SOURce&lt;hw&gt;]:BB:EUTRa:NOTCh&lt;ch&gt;:FREQUENCY:OFFSet</code> .....	1134
<code>[[:SOURce&lt;hw&gt;]:BB:OFDM:NOTCh&lt;ch&gt;:FREQUENCY:OFFSet</code> .....	1134
<code>[[:SOURce&lt;hw&gt;]:BB:ONEWeb:NOTCh&lt;ch&gt;:FREQUENCY:OFFSet</code> .....	1134
<code>[[:SOURce&lt;hw&gt;]:BB:ARbitrary:NOTCh&lt;ch&gt;:FREQUENCY:OFFSet</code> .....	1134
<code>[[:SOURce&lt;hw&gt;]:BB:DVB:NOTCh&lt;ch&gt;:BWIDth[:ABSolute]</code> .....	1134
<code>[[:SOURce&lt;hw&gt;]:BB:EUTRa:NOTCh&lt;ch&gt;:BWIDth[:ABSolute]</code> .....	1134
<code>[[:SOURce&lt;hw&gt;]:BB:OFDM:NOTCh&lt;ch&gt;:BWIDth[:ABSolute]</code> .....	1134
<code>[[:SOURce&lt;hw&gt;]:BB:ONEWeb:NOTCh&lt;ch&gt;:BWIDth[:ABSolute]</code> .....	1134
<code>[[:SOURce&lt;hw&gt;]:BB:ARbitrary:NOTCh&lt;ch&gt;:BWIDth[:ABSolute]</code> .....	1134
<code>[[:SOURce&lt;hw&gt;]:BB:DVB:NOTCh&lt;ch&gt;:BWIDth:RELative</code> .....	1135
<code>[[:SOURce&lt;hw&gt;]:BB:EUTRa:NOTCh&lt;ch&gt;:BWIDth:RELative</code> .....	1135
<code>[[:SOURce&lt;hw&gt;]:BB:OFDM:NOTCh&lt;ch&gt;:BWIDth:RELative</code> .....	1135
<code>[[:SOURce&lt;hw&gt;]:BB:ONEWeb:NOTCh&lt;ch&gt;:BWIDth:RELative</code> .....	1135
<code>[[:SOURce&lt;hw&gt;]:BB:ARbitrary:NOTCh&lt;ch&gt;:BWIDth:RELative</code> .....	1135
<code>[[:SOURce&lt;hw&gt;]:BB:DVB:NOTCh:APPLY</code> .....	1135
<code>[[:SOURce&lt;hw&gt;]:BB:EUTRa:NOTCh:APPLY</code> .....	1135
<code>[[:SOURce&lt;hw&gt;]:BB:OFDM:NOTCh:APPLY</code> .....	1135
<code>[[:SOURce&lt;hw&gt;]:BB:ONEWeb:NOTCh:APPLY</code> .....	1135
<code>[[:SOURce&lt;hw&gt;]:BB:ARbitrary:NOTCh:APPLY</code> .....	1135

---

`[[:SOURce<hw>]:BB:DVB:NOTCh <NotchState>`  
`[[:SOURce<hw>]:BB:EUTRa:NOTCh <NotchState>`  
`[[:SOURce<hw>]:BB:OFDM:NOTCh <NotchState>`

```
[ :SOURce<hw>]:BB:ONEWeb:NOTCh <NotchState>
[ :SOURce<hw>]:BB:ARbitrary:NOTCh <NotchState>
```

Enables or disables the notch filter.

**Parameters:**

```
<NotchState>      1 | ON | 0 | OFF
                  *RST:      0
```

**Example:** See [Example "Creating notch filter"](#) on page 1101.

**Manual operation:** See ["State"](#) on page 356

```
[ :SOURce<hw>]:BB:DVB:NOTCh:CLOCK?
[ :SOURce<hw>]:BB:EUTRa:NOTCh:CLOCK?
[ :SOURce<hw>]:BB:OFDM:NOTCh:CLOCK?
[ :SOURce<hw>]:BB:ONEWeb:NOTCh:CLOCK?
[ :SOURce<hw>]:BB:ARbitrary:NOTCh:CLOCK?
```

Queries the current clock frequency of the waveform signal.

Works like the command `[ :SOURce<hw>]:BB:ARbitrary:CLOCK`.

**Return values:**

```
<ChBw>            integer
                  Range:      400 to 2000E6
                  *RST:      1E6
```

**Example:** See [Example "Creating notch filter"](#) on page 1101.

**Usage:** Query only

**Manual operation:** See ["Clock Frequency"](#) on page 356

```
[ :SOURce<hw>]:BB:DVB:NOTCh:COUNT <NumOfNotch>
[ :SOURce<hw>]:BB:EUTRa:NOTCh:COUNT <NumOfNotch>
[ :SOURce<hw>]:BB:OFDM:NOTCh:COUNT <NumOfNotch>
[ :SOURce<hw>]:BB:ONEWeb:NOTCh:COUNT <NumOfNotch>
[ :SOURce<hw>]:BB:ARbitrary:NOTCh:COUNT <IdPDbNotchedNum>
```

Sets the number of notches.

**Parameters:**

```
<IdPDbNotchedNum> integer
                  Range:      1 to 25
                  *RST:      1
```

**Example:** See [Example "Creating notch filter"](#) on page 1101.

**Manual operation:** See ["Number of Notches"](#) on page 356

```
[ :SOURce<hw>]:BB:DVB:NOTCh<ch>:STATe <ValEnable>
[ :SOURce<hw>]:BB:EUTRa:NOTCh<ch>:STATe <NotchState>
[ :SOURce<hw>]:BB:OFDM:NOTCh<ch>:STATe <NotchValEnable>
```

```
[ :SOURce<hw>]:BB:ONEWeb:NOTCh<ch>:STATe <ValEnable>
[:SOURce<hw>]:BB:ARbitrary:NOTCh<ch>:STATe <ValEnable>
```

Enables the particular notch.

**Parameters:**

```
<ValEnable>      1 | ON | 0 | OFF
                  *RST:      0
```

**Example:** See [Example "Creating notch filter"](#) on page 1101.

**Manual operation:** See ["State"](#) on page 356

```
[ :SOURce<hw>]:BB:DVB:NOTCh<ch>:FREQUency:OFFSet <FreqOffs>
[:SOURce<hw>]:BB:EUTRa:NOTCh<ch>:FREQUency:OFFSet <FreqOffs>
[:SOURce<hw>]:BB:OFDM:NOTCh<ch>:FREQUency:OFFSet <FreqOffs>
[:SOURce<hw>]:BB:ONEWeb:NOTCh<ch>:FREQUency:OFFSet <FreqOffs>
[:SOURce<hw>]:BB:ARbitrary:NOTCh<ch>:FREQUency:OFFSet <ChBw>
```

Specifies the center frequency of the notch

**Parameters:**

```
<ChBw>           integer
                  Range:     -2000E6 to 2000E6
                  Increment:  dynamic
                  *RST:      0
```

**Example:** See [Example "Creating notch filter"](#) on page 1101.

**Manual operation:** See ["Frequency Offset \(kHz\)"](#) on page 357

```
[ :SOURce<hw>]:BB:DVB:NOTCh<ch>:BWIDth[:ABSolute] <BwHz>
[:SOURce<hw>]:BB:EUTRa:NOTCh<ch>:BWIDth[:ABSolute] <BwHz>
[:SOURce<hw>]:BB:OFDM:NOTCh<ch>:BWIDth[:ABSolute] <BwHz>
[:SOURce<hw>]:BB:ONEWeb:NOTCh<ch>:BWIDth[:ABSolute] <BwHz>
[:SOURce<hw>]:BB:ARbitrary:NOTCh<ch>:BWIDth[:ABSolute] <NoBw>
```

Sets the absolute notch bandwidth.

The value is interdependent with the relative bandwidth value, set with the command [\[:SOURce<hw>\]:BB:ARbitrary:NOTCh<ch>:BWIDth:RELative](#).

That is, you can set the notch bandwidth in either way.

**Parameters:**

```
<NoBw>          float
                  Range:     0 to dynamic
                  Increment:  dynamic
                  *RST:      dynamic
```

**Example:** See [Example "Creating notch filter"](#) on page 1101.

**Manual operation:** See ["Notch Bandwidth \(kHz\)"](#) on page 357

---

```
[:SOURce<hw>]:BB:DVB:NOTCh<ch>:BWIDth:RELative <BwPct>
[:SOURce<hw>]:BB:EUTRa:NOTCh<ch>:BWIDth:RELative <BwPct>
[:SOURce<hw>]:BB:OFDM:NOTCh<ch>:BWIDth:RELative <BwPct>
[:SOURce<hw>]:BB:ONEWeb:NOTCh<ch>:BWIDth:RELative <BwPct>
[:SOURce<hw>]:BB:ARBitrary:NOTCh<ch>:BWIDth:RELative <NoBwRel>
```

Sets the notch bandwidth relative to current clock frequency (`[ :SOURce<hw> ] :BB:ARBitrary:NOTCh:CLOCK?`).

The value is interdependent with the absolute bandwidth value, set with the command `[ :SOURce<hw> ] :BB:ARBitrary:NOTCh<ch>:BWIDth [ :ABSolute ]`.

That is, you can set the notch bandwidth in either way.

**Parameters:**

<NoBwRel>	float
	Range: 0 to 10
	Increment: 0.01
	*RST: 5

**Example:** See [Example "Creating notch filter"](#) on page 1101.

**Manual operation:** See ["Notch Bandwidth \(%\)"](#) on page 357

---

```
[:SOURce<hw>]:BB:DVB:NOTCh:APPLY
[:SOURce<hw>]:BB:EUTRa:NOTCh:APPLY
[:SOURce<hw>]:BB:OFDM:NOTCh:APPLY
[:SOURce<hw>]:BB:ONEWeb:NOTCh:APPLY
[:SOURce<hw>]:BB:ARBitrary:NOTCh:APPLY
```

Adopt the configured settings.

**Example:** See [Example "Creating notch filter"](#) on page 1101.

**Usage:** Event

**Manual operation:** See ["Apply"](#) on page 358

**Trigger commands**

This section provides trigger commands for the `SOURce:BB:ARBitrary` subsystem.

**Example: To configure trigger settings**

This example provides the commands to configure the trigger settings.

```
// *****
// Configure for a single trigger event.
// *****
SOURcel:BB:ARbitrary:TRIGger:SEQuence SINGLE
SOURcel:BB:ARbitrary:TRIGger:SLUNit SAMPLEs
SOURcel:BB:ARbitrary:TRIGger:SLENgth 200
// Outputs the first 200 samples of the waveform after the next trigger event.
SOURcel:BB:ARbitrary:TRIGger:SOURce?
// Response: "INTernal"
SOURcel:BB:ARbitrary:STATe ON

// *****
// Configure for an external trigger event.
// *****
SOURcel:BB:ARbitrary:TRIGger:SEQuence ARETrigger
// Sets the armed retrigger mode.
SOURcel:BB:ARbitrary:TRIGger:SOURce EGT1
// Expects an external trigger signal at a USER connector.
SOURcel:BB:ARbitrary:TRIGger:EXternal:SYNChronize:OUTPut ON
// Synchronizes the baseband signal output to the external trigger event.
// Query the processing time between the input of the external trigger event
// and the output of the baseband signal.
SOURcel:BB:ARbitrary:TRIGger:PTIME?
// Response: "0.00021"
// The processing time is 210 mircoseconds.
// Optionally, add a trigger delay.
SOURcel:BB:ARbitrary:TRIGger:EXternal:DELay 200
SOURcel:BB:ARbitrary:TRIGger:EXternal:INHibit 100
SOURcel:BB:ARbitrary:STATe ON

// *****
// Execute an internal trigger manually.
// *****
SOURcel:BB:ARbitrary:TRIGger:SEQuence AAUTO
SOURcel:BB:ARbitrary:TRIGger:SOURce INTernal
SOURcel:BB:ARbitrary:STATe ON
SOURcel:BB:ARbitrary:TRIGger:EXEC
SOURcel:BB:ARbitrary:TRIGger:RMODe?
// Response: "RUN"
```

**Example: To specify delay and inhibit values in time units**

The following example lists the commands to configure trigger delays and trigger inhibit values. See also ["To set delay and inhibit values"](#) on page 242.

```
SOURcel:BB:ARbitrary:TRIGger:SEQuence AAUT
SOURcel:BB:ARbitrary:TRIGger:SOURce EGT1
SOURcel:BB:ARbitrary:TRIGger:DELay:UNIT SAMP
SOURcel:BB:ARbitrary:TRIGger:EXternal:DELay 100
```



```

SOURcel:BB:ARbitrary:TRIGger:EXternal:RDElay?
// Response in samples: 100
SOURcel:BB:ARbitrary:TRIGger:DElay:UNIT TIME
SOURcel:BB:ARbitrary:TRIGger:EXternal:TDElay 0.00001
SOURcel:BB:ARbitrary:TRIGger:EXternal:RDElay?
// Response in seconds: 0.00001
// The actual external delay is 10 microseconds.
SOURcel:BB:ARbitrary:TRIGger:DElay:UNIT SAMP
SOURcel:BB:ARbitrary:TRIGger:EXternal:DElay 10

```

### Example: Configure a time-based trigger signal

Configuring a time-based trigger is analogous for all digital standards that support this feature. This example illustrates time-based triggering for the arbitrary waveform generator.

You can use the configuration for other digital standards by replacing the `ARbitrary` mnemonic, for example, replace it with `NR5G` for 5G NR digital standard.

```

// *****
Configure an internal time-based trigger signal.
// *****
SOURcel:BB:ARbitrary:TRIGger:SEQuence SINGLE
SOURcel:BB:ARbitrary:TRIGger:MODE INTERNAL
// Configure time-based trigger settings.
SOURcel:BB:ARbitrary:TRIGger:TIME:DATE 2023,10,1
// Time-based trigger signal date is 2023-10-01 in format YYYY-MM-DD.
SOURcel:BB:ARbitrary:TRIGger:TIME:TIME 11,0,0
// Time-based trigger signal time is 11 a.m. in format hh:mm:ss.
SOURcel:BB:ARbitrary:TRIGger:TIME:STATE 1
// Activates time-based triggering. That means, trigger signal generation, if
// the operating system time matches date and time of the time-based trigger.
SOURcel:BB:ARbitrary:STATE 1

// Query the operating system date and time of your R&S SMW200A.
SYSTEM:DATE?
// Response: "2023,10,1"
// The date matches the date of the time-based trigger.
SYSTEM:TIME?
// Response 10,59,50.
// The system time is 10 seconds before the time of the time-based trigger.
// Query if the trigger is active.
SOURcel:BB:ARbitrary:TRIGger:RMODE?
// Response: "STOP"
// Query system time again.
SYSTEM:TIME?
// Response 11,0,50.
// The system time equals the time of the time-based trigger.
// Query if the trigger is active.
SOURcel:BB:ARbitrary:TRIGger:RMODE?
// Response: "RUN"

```

**Commands:**

<code>[SOURce&lt;hw&gt;]:BB:ARbitrary[:TRIGger]:SEQUence</code> .....	1138
<code>[SOURce&lt;hw&gt;]:BB:ARbitrary:TRIGger:SOURce</code> .....	1138
<code>[SOURce&lt;hw&gt;]:BB:ARbitrary:TRIGger:RMODE?</code> .....	1139
<code>[SOURce&lt;hw&gt;]:BB:ARbitrary:TRIGger:TIME:DATE</code> .....	1140
<code>[SOURce&lt;hw&gt;]:BB:ARbitrary:TRIGger:TIME:TIME</code> .....	1140
<code>[SOURce&lt;hw&gt;]:BB:ARbitrary:TRIGger:TIME[:STATE]</code> .....	1141
<code>[SOURce&lt;hw&gt;]:BB:ARbitrary:TRIGger:SLENgth</code> .....	1141
<code>[SOURce&lt;hw&gt;]:BB:ARbitrary:TRIGger:SLUNit</code> .....	1141
<code>[SOURce&lt;hw&gt;]:BB:ARbitrary:TRIGger:ARM:EXECute</code> .....	1142
<code>[SOURce&lt;hw&gt;]:BB:ARbitrary:TRIGger:EXECute</code> .....	1142
<code>[SOURce&lt;hw&gt;]:BB:ARbitrary:TRIGger[:EXTernal]:SYNChronize:OUTPut</code> .....	1142
<code>[SOURce&lt;hw&gt;]:BB:ARbitrary:TRIGger:PTIME?</code> .....	1142
<code>[SOURce&lt;hw&gt;]:BB:ARbitrary:TRIGger:OBASeband:DELay</code> .....	1142
<code>[SOURce&lt;hw&gt;]:BB:ARbitrary:TRIGger:OBASeband:RDELay?</code> .....	1143
<code>[SOURce&lt;hw&gt;]:BB:ARbitrary:TRIGger:OBASeband:TDELay</code> .....	1143
<code>[SOURce&lt;hw&gt;]:BB:ARbitrary:TRIGger:OBASeband:INHibit</code> .....	1143
<code>[SOURce&lt;hw&gt;]:BB:ARbitrary:TRIGger:DELay:UNIT</code> .....	1144
<code>[SOURce&lt;hw&gt;]:BB:ARbitrary:TRIGger[:EXTernal]:DELay</code> .....	1144
<code>[SOURce&lt;hw&gt;]:BB:ARbitrary:TRIGger[:EXTernal]:TDELay</code> .....	1144
<code>[SOURce&lt;hw&gt;]:BB:ARbitrary:TRIGger[:EXTernal]:RDELay?</code> .....	1145
<code>[SOURce&lt;hw&gt;]:BB:ARbitrary:TRIGger[:EXTernal]:INHibit</code> .....	1145

**[SOURce<hw>]:BB:ARbitrary[:TRIGger]:SEQUence <Sequence>**

Selects the trigger mode:

- AUTO = auto
- RETRigger = retrigger
- AAUTO = armed auto
- ARETRigger = armed retrigger
- SINGLE = single

See also ["About trigger modes"](#) on page 237.

**Parameters:**

<Sequence>            AUTO | RETRigger | AAUTO | ARETRigger | SINGLE  
 \*RST:                AUTO

**Example:**            See [Example "To configure trigger settings"](#) on page 1136.

**Manual operation:**    See ["Mode"](#) on page 253

**[SOURce<hw>]:BB:ARbitrary:TRIGger:SOURce <Source>**

Selects the trigger signal source and determines the way the triggering is executed. Provided are the following trigger sources:

- INTernal: Internal manual triggering of the instrument
- INTA | INTB: Internal triggering by a signal from the other basebands

- External trigger signal via one of the local or global connectors:
  - EGT1|EGT2: External global trigger
  - EGC1|EGC2: External global clock
  - ELTRigger: External local trigger
  - ELCLock: External local clock
- For secondary instruments (SCONfiguration:MULTIinstrument:MODE SEC), triggering via the external baseband synchronization signal of the primary instrument:
 

```
SOURce1:BB:ARB:TRIGger:SOURce BBSY
```
- OBASeband|BEXTernal|EXTernal: Setting only
 

Provided only for backward compatibility with other Rohde & Schwarz signal generators. The R&S SMW200A accepts these values and maps them automatically as follows:

```
EXTernal = EGT1, BEXTernal = EGT2, OBASeband = INTA or INTB
```

 (depending on the current baseband)

**Parameters:**

<Source> INTB|INTernal|OBASeband|EGT1|EGT2|EGC1|EGC2|ELTRigger|INTA|ELCLock|BEXTernal|EXTernal | BBSY  
 \*RST: INTernal

**Example:** See [Example "To configure trigger settings"](#) on page 1136.

**Options:** ELTRigger|ELCLock require R&S SMW-B10.  
 BBSY requires R&S SMW-B9.

**Manual operation:** See ["Source"](#) on page 255

**[ :SOURce<hw>]:BB:ARbitrary:TRIGger:RMODE?**

Queries the status of waveform output.

**Return values:**

<RMode> STOP | RUN  
**RUN**  
 Outputs the waveform. A trigger event occurred in the triggered mode.  
**STOP**  
 No waveform output. A trigger event did not occur in the triggered modes, or waveform output was stopped/armed.

**Example:** See [Example "To configure trigger settings"](#) on page 1136.

**Usage:** Query only

**Manual operation:** See ["Running/Stopped"](#) on page 254

---

**[:SOURce<hw>]:BB:ARbitrary:TRIGger:TIME:DATE <Year>, <Month>, <Day>**

Sets the date for a time-based trigger signal. For trigger modes single or armed auto, you can activate triggering at this date via the following command:

```
SOURce<hw>:BB:<DigStd>:TRIGger:TIME:STATe
```

<DigStd> is the mnemonic for the digital standard, for example, ARB. Time-based triggering behaves analogously for all digital standards that support this feature.

**Parameters:**

<Year>	integer	
	Range:	1980 to 9999
<Month>	integer	
	Range:	1 to 12
<Day>	integer	
	Range:	1 to 31

**Example:** See [Example "Configure a time-based trigger signal"](#) on page 1137.

**Manual operation:** See ["Trigger Time"](#) on page 254

---

**[:SOURce<hw>]:BB:ARbitrary:TRIGger:TIME:TIME <Hour>, <Minute>, <Second>**

Sets the time for a time-based trigger signal. For trigger modes single or armed auto, you can activate triggering at this time via the following command:

```
SOURce<hw>:BB:<DigStd>:TRIGger:TIME:STATe
```

<DigStd> is the mnemonic for the digital standard, for example, ARB. Time-based triggering behaves analogously for all digital standards that support this feature.

**Parameters:**

<Hour>	integer	
	Range:	0 to 23
<Minute>	integer	
	Range:	0 to 59
<Second>	integer	
	Range:	0 to 59

**Example:** See [Example "Configure a time-based trigger signal"](#) on page 1137.

**Manual operation:** See ["Trigger Time"](#) on page 254

**[ :SOURce<hw>]:BB:ARbitrary:TRIGger:TIME[:STATe] <State>**

Activates time-based triggering with a fixed time reference. If activated, the R&S SMW200A triggers signal generation when its operating system time matches a specified time.

Specify the trigger date and trigger time with the following commands:

```
SOURce<hw>:BB:<DigStd>:TRIGger:TIME:DATE
```

```
SOURce<hw>:BB:<DigStd>:TRIGger:TIME:TIME
```

<DigStd> is the mnemonic for the digital standard, for example, ARB. Time-based triggering behaves analogously for all digital standards that support this feature.

**Parameters:**

<State>                    1 | ON | 0 | OFF  
\*RST:                    0

**Example:**                See [Example "Configure a time-based trigger signal"](#) on page 1137.

**Manual operation:**    See ["Time Based Trigger"](#) on page 254

**[ :SOURce<hw>]:BB:ARbitrary:TRIGger:SLENgth <SLength>**

Sets the length of the signal sequence that is output in the SINGLE trigger mode.

**Parameters:**

<SLength>                integer  
The maximum value depends on the selected units [ :  
[SOURce<hw>\]:BB:ARbitrary:TRIGger:SLUNit](#) as follows:  
SAMPLe: Max =  $2^{32}-1$   
SEQuence: Max = 1000  
Range:                  1 to dynamic  
\*RST:                    1

**Example:**                See [Example "To configure trigger settings"](#) on page 1136.

**[ :SOURce<hw>]:BB:ARbitrary:TRIGger:SLUNit <SLUnit>**

Sets the unit for the entry of the length of the signal sequence to be output in the Single trigger mode.

**Parameters:**

<SLUnit>                 SEQuence | SAMPLe  
\*RST:                    SEQuence

**Example:**                See [Example "To configure trigger settings"](#) on page 1136.

**Manual operation:**    See ["Signal Duration"](#) on page 257

---

**[:SOURce<hw>]:BB:ARbitrary:TRIGger:ARM:EXECute**

Stops the waveform output to arm the trigger.

**Example:** See [Example "To manage waveform files"](#) on page 1094.

**Usage:** Event

**Manual operation:** See ["Arm"](#) on page 255

---

**[:SOURce<hw>]:BB:ARbitrary:TRIGger:EXECute**

Triggers signals generation manually for an internal trigger event.

**Example:** See [Example "To configure trigger settings"](#) on page 1136.

**Usage:** Event

**Manual operation:** See ["Execute Trigger"](#) on page 255

---

**[:SOURce<hw>]:BB:ARbitrary:TRIGger[:EXTernal]:SYNChronize:OUTPut  
<Output>**

Enables signal output synchronous to the trigger event.

**Parameters:**

<Output> 1 | ON | 0 | OFF

\*RST: 1

**Example:** See [Example "To configure trigger settings"](#) on page 1136.

**Manual operation:** See ["Sync. Output to Ext. Trigger/Sync. Output to Trigger"](#) on page 256

---

**[:SOURce<hw>]:BB:ARbitrary:TRIGger:PTIME?**

Queries the internal processing time.

The processing time is the elapsed time between the input of the external trigger event and the output of the baseband signal.

**Return values:**

<ArbTrigProcTime> string

**Example:** See [Example "To configure trigger settings"](#) on page 1136.

**Usage:** Query only

**Manual operation:** See ["Processing Time"](#) on page 318

---

**[:SOURce<hw>]:BB:ARbitrary:TRIGger:OBASeband:DELay <Delay>**

Delays the trigger event compared to the trigger event in the other basebands.

**Parameters:**

<Delay> float  
 Range: 0 to 2147483647  
 Increment: 0.01  
 \*RST: 0

**Manual operation:** See "[\(Specified\) External Delay/\(Specified\) Trigger Delay](#)" on page 257

**[[:SOURce<hw>]:BB:ARbitrary:TRIGger:OBASeband:RDElay?**

Queries the time a trigger event from the other path is delayed.

**Return values:**

<ResTimeDelaySec> float  
 Range: 0 to 688  
 Increment: 0.25E-9  
 \*RST: 0  
 Default unit: s

**Example:** See [Example "To configure trigger settings"](#) on page 1136.

**Usage:** Query only

**Manual operation:** See "[Actual Trigger Delay/Actual External Delay](#)" on page 257

**[[:SOURce<hw>]:BB:ARbitrary:TRIGger:OBASeband:TDElay <ObasTimeDelay>**

Sets the delay to trigger signal generation with the signal from the other signal path.

Maximum trigger delay and trigger inhibit values depend on the installed options. See "[To set delay and inhibit values](#)" on page 242.

**Parameters:**

<ObasTimeDelay> float  
 Range: 0 to depends on the symbol rate  
 Increment: 0.25E-9  
 \*RST: 0  
 Default unit: s

**Example:** See [Example "To specify delay and inhibit values in time units"](#) on page 1136.

**Manual operation:** See "[\(Specified\) External Delay/\(Specified\) Trigger Delay](#)" on page 257

**[[:SOURce<hw>]:BB:ARbitrary:TRIGger:OBASeband:INHibit <Inhibit>**

For triggering via the other path, specifies the number of samples by which a restart is inhibited.

**Parameters:**

<Inhibit> integer  
 Range: 0 to 67108863  
 \*RST: 0  
 Default unit: sample

**Example:** See [Example "To specify delay and inhibit values in time units"](#) on page 1136.

**Manual operation:** See ["External Inhibit/Trigger Inhibit"](#) on page 256

**[:SOURce<hw>]:BB:ARBitrary:TRIGger:DElay:UNIT <TrigDelUnit>**

Sets the unit of the trigger delay.

**Parameters:**

<TrigDelUnit> SAMPlE | TIME  
 \*RST: SAMPlE

**Example:** See [Example "To specify delay and inhibit values in time units"](#) on page 1136.

**Manual operation:** See ["\(External\) Delay Unit"](#) on page 256

**[:SOURce<hw>]:BB:ARBitrary:TRIGger[:EXTErnal]:DElay <Delay>**

Specifies the trigger delay in samples.

Maximum trigger delay and trigger inhibit values depend on the installed options. See ["To set delay and inhibit values"](#) on page 242.

**Parameters:**

<Delay> float  
 Range: 0 to depends on the sample rate  
 Increment: 0.01  
 \*RST: 0  
 Default unit: sample  
 E.g., 0 to 2147483647 samples (R&S SMW-B10)

**Example:** See [Example "To specify delay and inhibit values in time units"](#) on page 1136.

**Manual operation:** See ["\(Specified\) External Delay/\(Specified\) Trigger Delay"](#) on page 257

**[:SOURce<hw>]:BB:ARBitrary:TRIGger[:EXTErnal]:TDElay <ExtTimeDelay>**

Specifies the trigger delay for external triggering. The value affects all external trigger signals.

Maximum trigger delay and trigger inhibit values depend on the installed options. See ["To set delay and inhibit values"](#) on page 242.



**Parameters:**

<ExtTimeDelay> float  
 Range: 0 to 2147483647 / (clock frequency)  
 Increment: 1E-9  
 \*RST: 0  
 Default unit: s

**Example:** See [Example "To specify delay and inhibit values in time units"](#) on page 1136.

**Manual operation:** See ["\(Specified\) External Delay/\(Specified\) Trigger Delay"](#) on page 257

**[[:SOURce<hw>]:BB:ARbitrary:TRIGger[:EXternal]:RDElay?**

Queries the time (in seconds) an external trigger event is delayed for.

**Return values:**

<ResTimeDelaySec> float  
 Range: 0 to 688  
 Increment: 0.25E-9  
 \*RST: 0

**Example:** See [Example "To specify delay and inhibit values in time units"](#) on page 1136.

**Usage:** Query only

**Manual operation:** See ["Actual Trigger Delay/Actual External Delay"](#) on page 257

**[[:SOURce<hw>]:BB:ARbitrary:TRIGger[:EXternal]:INHibit <Inhibit>**

Sets the number of samples that inhibit a restart of the signal generation.

Maximum trigger delay and trigger inhibit values depend on the installed options. See ["To set delay and inhibit values"](#) on page 242.

**Parameters:**

<Inhibit> integer  
 Range: 0 to 21.47 \* (clock frequency)  
 \*RST: 0  
 Default unit: samples  
 E.g., 0 to 2147483647 samples (R&S SMW-B10)

**Example:** See [Example "To specify delay and inhibit values in time units"](#) on page 1136.

**Manual operation:** See ["External Inhibit/Trigger Inhibit"](#) on page 256

**Marker commands**

<code>[:SOURce&lt;hw&gt;]:BB:ARbitrary:TRIGger:OUTPut&lt;ch&gt;:MODE</code> .....	1146
<code>[:SOURce&lt;hw&gt;]:BB:ARbitrary:TRIGger:OUTPut&lt;ch&gt;:ONTime</code> .....	1146
<code>[:SOURce&lt;hw&gt;]:BB:ARbitrary:TRIGger:OUTPut&lt;ch&gt;:OFFTime</code> .....	1146
<code>[:SOURce&lt;hw&gt;]:BB:ARbitrary:TRIGger:OUTPut&lt;ch&gt;:PATtern</code> .....	1146
<code>[:SOURce&lt;hw&gt;]:BB:ARbitrary:TRIGger:OUTPut&lt;ch&gt;:PULSe:DIVider</code> .....	1147
<code>[:SOURce&lt;hw&gt;]:BB:ARbitrary:TRIGger:OUTPut&lt;ch&gt;:PULSe:FREquency?</code> .....	1147
<code>[:SOURce&lt;hw&gt;]:BB:ARbitrary:TRIGger:OUTPut&lt;ch&gt;:DELay</code> .....	1147
<code>[:SOURce&lt;hw&gt;]:BB:ARbitrary:TRIGger:OUTPut&lt;ch&gt;:DINSec?</code> .....	1148

---

**`[:SOURce<hw>]:BB:ARbitrary:TRIGger:OUTPut<ch>:MODE <Mode>`**

Sets the marker mode that is the marker signal for the selected marker output.

See also "[Marker modes](#)" on page 232.

**Parameters:**

<Mode> UNCHanged | RESTart | PULSe | PATtern | RATio

**UNCHanged**

A marker signal as defined in the waveform file (tag 'marker mode x') is generated.

\*RST: UNCHanged

**Example:** See [Example "To configure marker signals"](#) on page 1095.

**Manual operation:** See "[Mode](#)" on page 318

---

**`[:SOURce<hw>]:BB:ARbitrary:TRIGger:OUTPut<ch>:ONTime <OnTime>`**

**`[:SOURce<hw>]:BB:ARbitrary:TRIGger:OUTPut<ch>:OFFTime <OffTime>`**

Sets the number of samples or duration of the marker-on and marker-off periods.

\*) If R&S SMW-B9 is installed, the minimum marker duration depends on the sample/symbol rate.

See "[Marker minimum duration](#)" on page 234.

**Parameters:**

<OffTime> integer

Range: 1 (R&S SMW-B10) / 1\* (R&S SMW-B9) to 14913079

\*RST: 1

**Example:** See [Example "To configure marker signals"](#) on page 1095.

**Manual operation:** See "[Mode](#)" on page 318

---

**`[:SOURce<hw>]:BB:ARbitrary:TRIGger:OUTPut<ch>:PATtern <Pattern>, <BitCount>`**

Sets the bit pattern to generate the marker signal.

**Parameters:**

<Pattern> numeric  
 \*RST: #H2

<BitCount> integer  
 0 = marker off, 1 = marker on  
 Range: 1 to 64  
 \*RST: 2

**Example:** See [Example "To configure marker signals"](#) on page 1095.

**Manual operation:** See ["Mode"](#) on page 318

**[:SOURce<hw>]:BB:ARbitrary:TRIGger:OUTPut<ch>:PULSe:DIVider <Divider>**

Sets the divider for the pulsed marker signal.

\*) If R&S SMW-B9 is installed, the minimum marker duration depends on the sample/symbol rate.

See ["Marker minimum duration"](#) on page 234.

**Parameters:**

<Divider> integer  
 Range: 2 (R&S SMW-B10) / 2\* (R&S SMW-B9) to 1024  
 \*RST: 2

**Example:** See [Example "To configure marker signals"](#) on page 1095.

**Manual operation:** See ["Mode"](#) on page 318

**[:SOURce<hw>]:BB:ARbitrary:TRIGger:OUTPut<ch>:PULSe:FREQuency?**

Queries the pulse frequency of the pulsed marker signal. The pulse frequency is the symbol rate divided by the divider.

**Return values:**

<Frequency> float  
 Increment: 0.001

**Example:** See [Example "To configure marker signals"](#) on page 1095.

**Usage:** Query only

**Manual operation:** See ["Mode"](#) on page 318

**[:SOURce<hw>]:BB:ARbitrary:TRIGger:OUTPut<ch>:DELay <Delay>**

Sets the delay between the signal on the marker outputs and the start of the signal.

**Parameters:**

<Delay> integer  
 Range: 0 to depends on other values  
 Increment: 0.001  
 \*RST: 0  
 Default unit: Symbol

**Example:** See [Example "To configure marker signals"](#) on page 1095.

**Manual operation:** See ["Delay"](#) on page 259

**[ :SOURce<hw>]:BB:ARBitrary:TRIGger:OUTPut<ch>:DINSec?**

Queries the marker delay in microseconds.

You can define a marker delay in samples via the following command:

[\[:SOURce<hw>\]:BB:ARBitrary:TRIGger:OUTPut<ch>:DELay](#) on page 1147

**Return values:**

<DelayInS> float  
 Range: 0 to 16777215  
 Increment: 1E-3  
 \*RST: 0

**Example:** See [Example "To configure marker signals"](#) on page 1095.

**Usage:** Query only

**Manual operation:** See ["Delay \(Time\)"](#) on page 319

**Clock commands****[ :SOURce<hw>]:BB:ARBitrary:CLOCK:SOURce <Source>**

Selects the clock source:

- `INTernal`: Internal clock reference
- `ELCLock`: External local clock
- `EXTernal = ELCLock`: Setting only  
 Provided for backward compatibility with other Rohde & Schwarz signal generators

**Parameters:**

<Source> INTernal|ELCLock|EXTernal  
 \*RST: INTernal

**Example:** See [Example "To configure clock settings"](#) on page 1095.

**Options:** ELCLock requires R&S SMW-B10

**Manual operation:** See ["Clock Source"](#) on page 260

**[:SOURce<hw>]:BB:ARbitrary:CLOCK:MODE <Mode>**

Enters the type of externally supplied clock.

**Parameters:**

<Mode>                    SAMPLE  
                              \*RST:        SAMPLE

**Example:**                See [Example "To configure clock settings"](#) on page 1095.

**Options:**                 R&S SMW-B10

**Manual operation:**    See ["Clock Mode"](#) on page 260

#### 14.19.5.4 SOURce:BB:MCCW subsystem

This subsystem contains the commands for setting the Multi-Carrier CW signals.



The generation of multi-carrier CW signals requires an instrument equipped with the software options R&S SMW-K61.

#### Common Suffixes

The following common suffixes are used in remote commands:

Suffix	Value range	Description
ENTity<ch>	1 to 4	Entity in a multiple entity configuration
SOURce<ch>	[1] to 4	Available baseband signals
OUTPut<ch>	1 to 3	Available markers

You can address multiple entities configurations by using the SCPI commands starting with the keyword `SOURce` or the alias commands starting with the keyword `ENTity`.

See also [Section 14.3, "SCPI command aliases for advanced mode with multiple entities"](#), on page 896.

#### Required options

See [Section 5.12.1, "Required options"](#), on page 409

#### Programming examples

The following examples illustrate how to generate multi-carrier signals for dedicated applications.

#### Example: Testing the frequency response of a DUT

```
// *****
// Reset the instrument first
// *****
*RST; *CLS
```

```

// *****
// Configuring and enabling the multi-carrier signal
// *****
SOURcel:BB:MCCW:CARRier:COUNT 81
SOURcel:BB:MCCW:CARRier:SPACing 1E6
// Set the number of carriers and their distance
// Further settings stay in default state, for example, trigger settings.
SOURcel:BB:MCCW:STATe ON
// Enable signal generation
OUTPut ON
// Enable the signal output

// *****
// Saving the current settings
// *****
MMEMemory:MDIR '/var/user/savrcl'
// Create a new directory "savrcl"
*SAV 4
MMEMemory:STORE:STATe 4,"/var/user/savrcl/mccw_SSB.savrcltxt"
// Save the current settings in an intermediate memory with number 4.
// Save the settings file in the specified directory, also specify the complete
// path and filename.

```

To visualize the configured signal as in [Example "Testing the frequency response of a DUT"](#) on page 1149, proceed as follows:

1. Switch to local mode with the following command:  
&NREN
2. To monitor the single carriers, select "Multi-carrier Continuous Wave" > "Carrier Graph".

#### **Example: Testing the image rejection of an SSB filter**

This example generates a multi-carrier single sideband signal as shown in [Figure 14-6](#).

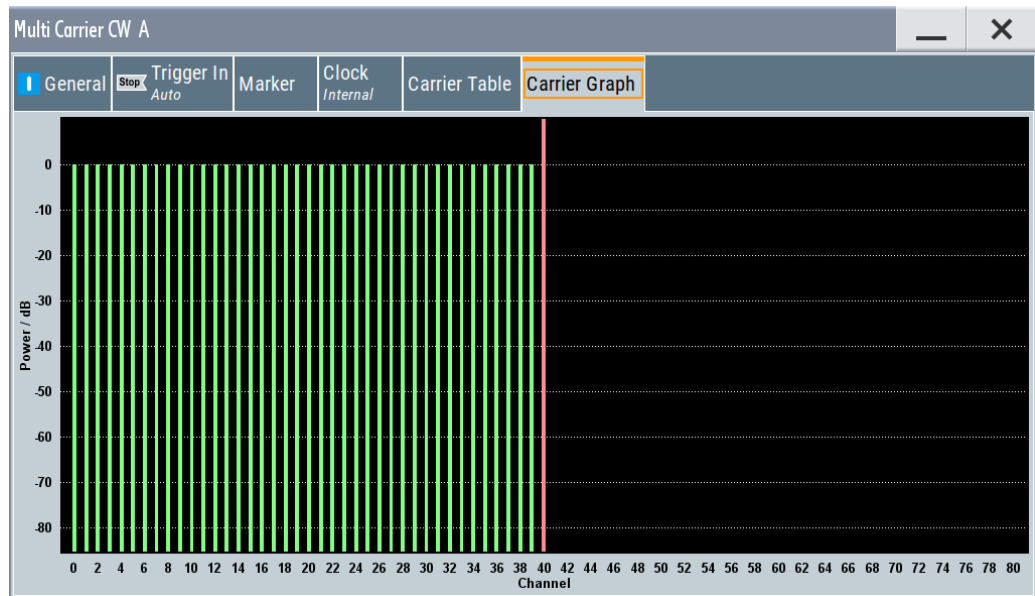

**Figure 14-6: Multi-carrier signal to test the image rejection of an SSB filter**

```
// *****
// Reset the instrument first
// *****
*RST; *CLS

// *****
// Configuring and enabling the multi-carrier signal
// *****
SOURcel:BB:MCCW:CARRier:COUNT 81
SOURcel:BB:MCCW:CARRier:SPACing 1E6
// Set the number of carriers and their distance
// Further settings stay in default state, for example, trigger settings.
SOURcel:BB:MCCW:EDIT:CARRier:START 40
SOURcel:BB:MCCW:EDIT:CARRier:STOP 80
SOURcel:BB:MCCW:EDIT:CARRier:STATe OFF
SOURcel:BB:MCCW:EDIT:CARRier:EXECute
// Configure the carrier table for the single sideband signal:
// Set the carriers no. 40 to 80 to "OFF"
SOURcel:BB:MCCW:STATe ON
// Enable signal generation
OUTPut ON
// Enable signal output.
```

### Example: Generating a composed multi-carrier signal

This example generates a multi-carrier signal as shown in [Figure 14-7](#).

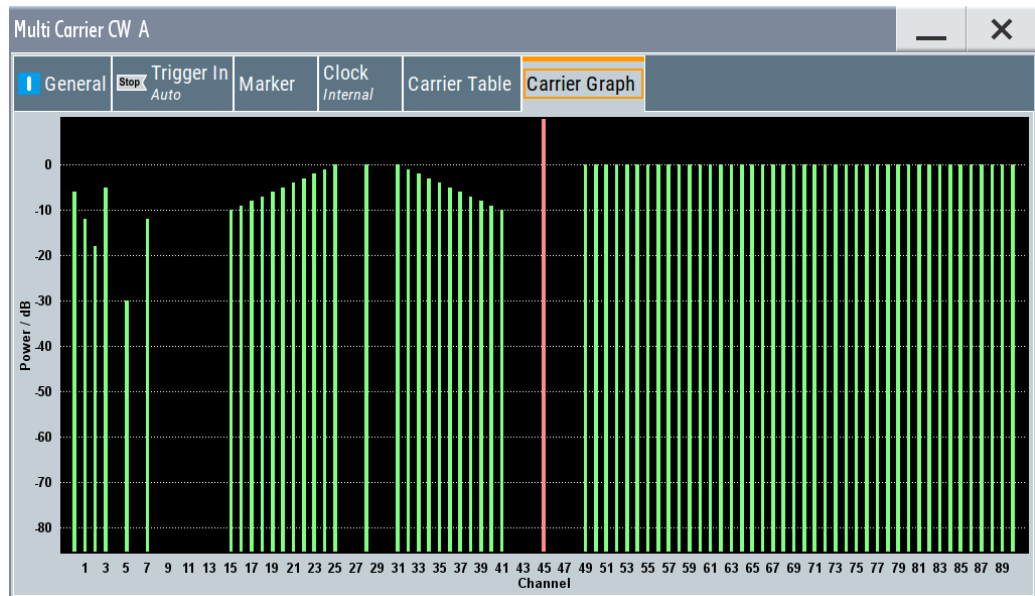

Figure 14-7: Composed multi-carrier signal

```
// *****
// Reset the instrument first
// *****
*RST; *CLS

// *****
// Configure the multi-carrier signal
// *****
SOURcel:BB:MCCW:CARRier:COUNT 100
SOURcel:BB:MCCW:CARRier:SPACing 500000
// Setup 100 carriers with a spacing of 500kHz
SOURcel:BB:MCCW:CLOCK?
// Return value 128000000
SOURcel:BB:MCCW:CFACTOR:MODE SLOW
SOURcel:BB:MCCW:CFACTOR 3
SOURcel:BB:MCCW:CFACTOR:ACTual?
// Response: "3"

// *****
// Adjust the settings of a group of carriers
// *****
SOURcel:BB:MCCW:CARRier:LIST:POWER -6,-12,-18,-12,-6,0
// Set the power levels for carriers no. 0 to 5 to -10dB,-15dB,-20dB,-15dB,-10dB,0dB
SOURcel:BB:MCCW:CARRier:LIST:STATE ON,ON,ON,ON,ON,ON,OFF,ON
// Set the state of the carriers no. 0 to 7
SOURcel:BB:MCCW:EDIT:CARRier:START 15
SOURcel:BB:MCCW:EDIT:CARRier:STOP 35
SOURcel:BB:MCCW:EDIT:CARRier:STATE ON
SOURcel:BB:MCCW:EDIT:CARRier:POWER:STAR -10
SOURcel:BB:MCCW:EDIT:CARRier:POWER:STEP 0.5
SOURcel:BB:MCCW:EDIT:CARRier:EXECute
```



```

// Activates the carriers no. 15 to 35
// Increase the power in 0.5dB steps starting with a power level of -10dB
// Apply the settings
SOURcel:BB:MCCW:CARRier:POWer 38,0
SOURcel:BB:MCCW:CARRier:STATe 38,1
// Set a power level of 0dB for carrier no. 38 and activates it
SOURcel:BB:MCCW:EDIT:CARRier:STARt 41
SOURcel:BB:MCCW:EDIT:CARRier:STOP 61
SOURcel:BB:MCCW:EDIT:CARRier:STATe ON
SOURcel:BB:MCCW:EDIT:CARRier:POWer:STARt 0
SOURcel:BB:MCCW:EDIT:CARRier:POWer:STEP -0.5
SOURcel:BB:MCCW:EDIT:CARRier:EXECute
// Activates the carriers no. 41 to 61
// Decrease the power in 0.5dB steps starting with a power level of 0dB
// Apply the settings.
SOURcel:BB:MCCW:EDIT:CARRier:STARt 70
SOURcel:BB:MCCW:EDIT:CARRier:STOP 85
SOURcel:BB:MCCW:EDIT:CARRier:STATe ON
SOURcel:BB:MCCW:EDIT:CARRier:EXECute
// Activates the carriers no. 70 to 85.
// Apply the settings.

// *****
// Configuring the clock settings
// *****
SOURcel:BB:MCCW:CLOCK:SOURce INTernal

// *****
// Configuring and enabling marker signals
// *****
SOURcel:BB:MCCW:TRIGger:OUTPut1:MODE REStart
SOURcel:BB:MCCW:TRIGger:OUTPut2:MODE PULSe
SOURcel:BB:MCCW:TRIGger:OUTPut2:PULSe:DIVider 5
SOURcel:BB:MCCW:TRIGger:OUTPut2:PULSe:FREQuency?
SOURcel:BB:MCCW:TRIGger:OUTPut3:MODE PATtern
SOURcel:BB:MCCW:TRIGger:OUTPut3:PATtern #HE0F52,20
// SOURcel:BB:MCCW:TRIGger:OUTPut1:MODE RATio
// SOURcel:BB:MCCW:TRIGger:OUTPut1:ONTime 40
// SOURcel:BB:MCCW:TRIGger:OUTPut1:OFFTime 20
SOURcel:BB:MCCW:TRIGger:OUTPut2:DELay 16

// *****
// Configuring and enabling signal triggering
// *****
SOURcel:BB:MCCW:TRIGger:SEQuence SINGLE
SOURcel:BB:MCCW:TRIGger:SLENgth 200
// The first 200 samples of the current waveform will be output after the next
// trigger event.
SOURcel:BB:MCCW:TRIGger:SEQuence ARETrigger
SOURcel:BB:MCCW:TRIGger:SOURce INTernal
// SOURcel:BB:MCCW:TRIGger:SOURce EGT1

```

```

// Provide an external global trigger signal at the connector that expects
// an external global trigger signal.
// SOURce1:BB:MCCW:TRIGger:EXTErnal:SYNChronize:OUTPut ON
// SOURce1:BB:MCCW:TRIGger:EXTErnal:DELay 200
// SOURce1:BB:MCCW:TRIGger:EXTErnal:INHibit 100

// SOURce1:BB:MCCW:TRIGger:SOURce OBASeband
// The internal trigger signal from the other path must be used
// SOURce1:BB:MCCW:TRIGger:OBASeband:DELay 25
// SOURce1:BB:MCCW:TRIGger:OBASeband:INHibit 10

// *****
// Applying the settings and enabling signal generation
// *****
*TRG
SOURce1:BB:MCCW:STATe ON
// Stop the internal trigger manually.
SOURce1:BB:MCCW:TRIGger:ARM:EXECute
// Execute manual internal trigger, i.e. restarting signal generation
SOURce1:BB:MCCW:TRIGger:EXECute
SOURce1:BB:MCCW:TRIGger:RMODE?
// Response: "RUN"

```

### General commands

<a href="#">[:SOURce&lt;hw&gt;]:BB:MCCW:PRESet</a> .....	1154
<a href="#">[:SOURce&lt;hw&gt;]:BB:MCCW:STATe</a> .....	1155
<a href="#">[:SOURce&lt;hw&gt;]:BB:MCCW:CARRier:COUNT</a> .....	1155
<a href="#">[:SOURce&lt;hw&gt;]:BB:MCCW:CARRier:SPACing</a> .....	1155
<a href="#">[:SOURce&lt;hw&gt;]:BB:MCCW:CLOCK?</a> .....	1156
<a href="#">[:SOURce&lt;hw&gt;]:BB:MCCW:CFACTor:MODE</a> .....	1156
<a href="#">[:SOURce&lt;hw&gt;]:BB:MCCW:CFACTor</a> .....	1156
<a href="#">[:SOURce&lt;hw&gt;]:BB:MCCW:CFACTor:ACTual?</a> .....	1156
<a href="#">[:SOURce&lt;hw&gt;]:BB:MCCW:CARRier:STATe</a> .....	1157
<a href="#">[:SOURce&lt;hw&gt;]:BB:MCCW:CARRier:LIST:STATe</a> .....	1157
<a href="#">[:SOURce&lt;hw&gt;]:BB:MCCW:CARRier:PHASe</a> .....	1158
<a href="#">[:SOURce&lt;hw&gt;]:BB:MCCW:CARRier:LIST:PHASe</a> .....	1158
<a href="#">[:SOURce&lt;hw&gt;]:BB:MCCW:CARRier:POWer</a> .....	1159
<a href="#">[:SOURce&lt;hw&gt;]:BB:MCCW:CARRier:LIST:POWer</a> .....	1159
<a href="#">[:SOURce&lt;hw&gt;]:BB:MCCW:EDIT:CARRier:PHASe[:START]</a> .....	1159
<a href="#">[:SOURce&lt;hw&gt;]:BB:MCCW:EDIT:CARRier:POWer[:START]</a> .....	1159
<a href="#">[:SOURce&lt;hw&gt;]:BB:MCCW:EDIT:CARRier:PHASe:STEP</a> .....	1160
<a href="#">[:SOURce&lt;hw&gt;]:BB:MCCW:EDIT:CARRier:POWer:STEP</a> .....	1160
<a href="#">[:SOURce&lt;hw&gt;]:BB:MCCW:EDIT:CARRier:START</a> .....	1160
<a href="#">[:SOURce&lt;hw&gt;]:BB:MCCW:EDIT:CARRier:STOP</a> .....	1160
<a href="#">[:SOURce&lt;hw&gt;]:BB:MCCW:EDIT:CARRier:STATe</a> .....	1161
<a href="#">[:SOURce&lt;hw&gt;]:BB:MCCW:EDIT:CARRier:EXECute</a> .....	1161

---

#### **[\[:SOURce<hw>\]:BB:MCCW:PRESet](#)**

Sets all multi carrier signal parameters to their default values.

**Example:** See ["Programming examples"](#) on page 1149

**Usage:** Event

**Manual operation:** See ["Set to Default"](#) on page 410

**[:SOURce<hw>]:BB:MCCW:STATe <State>**

Enables/disables the multi carrier CW signal.

**Parameters:**

<State> 1 | ON | 0 | OFF  
\*RST: 0

**Example:** See ["Programming examples"](#) on page 1149

**Manual operation:** See ["State"](#) on page 410

**[:SOURce<hw>]:BB:MCCW:CARRier:COUNT <Count>**

Sets the number of carriers in the multi carrier CW signal.

**Parameters:**

<Count> integer  
Range: 1 to 160001  
\*RST: 64

**Example:** see ["Programming examples"](#) on page 1149

**Manual operation:** See ["Number of Carriers"](#) on page 410

**[:SOURce<hw>]:BB:MCCW:CARRier:SPACing <Spacing>**

Sets the carrier spacing.

**Parameters:**

<Spacing> float  
Value range depends on the available bandwidth and the number of carriers, see ["Cross-reference between total bandwidth, carrier spacing, and number of carriers"](#) on page 410.  
Range: 0 to depends on the installed options, for example 120E6 (R&S SMW-B10)  
Increment: 0.01  
\*RST: 10E3

**Example:** See ["Programming examples"](#) on page 1149

**Manual operation:** See ["Carrier Spacing"](#) on page 411

---

**[:SOURce<hw>]:BB:MCCW:CLOCK?**

Queries the output clock rate. The output clock rate depends on the number of carriers and on the selected carrier spacing.

**Return values:**

<Clock> float  
 Range: 0 to Max  
 Increment: 1E-3  
 \*RST: 0

**Example:** See "[Programming examples](#)" on page 1149

**Usage:** Query only

**Manual operation:** See "[Clock Frequency](#)" on page 411

---

**[:SOURce<hw>]:BB:MCCW:CFACTOR:MODE <Mode>**

Sets the mode by which automatic settings minimize the crest factor or hold it at a chosen value.

**Parameters:**

<Mode> OFF | CHIRp | SLOW  
**SLOW**  
 corresponds to the manual control "Target Crest"  
 \*RST: CHIRp

**Example:** See "[Programming examples](#)" on page 1149

**Manual operation:** See "[Optimize Crest Factor Mode](#)" on page 411

---

**[:SOURce<hw>]:BB:MCCW:CFACTOR <CFactor>**

Sets the desired crest factor, if the optimization mode target crest factor is used.

**Parameters:**

<CFactor> float  
 Range: 0 to 30  
 Increment: 0.01  
 \*RST: 3

**Example:** See "[Programming examples](#)" on page 1149

**Manual operation:** See "[Desired Crest Factor](#)" on page 412

---

**[:SOURce<hw>]:BB:MCCW:CFACTOR:ACTUAL?**

Queries the actual Crest Factor for optimization mode target crest.

**Return values:**

<Actual> float  
 Range: 0 to 100  
 Increment: 0.01  
 \*RST: 3

**Example:** See "[Programming examples](#)" on page 1149

**Usage:** Query only

**[:SOURce<hw>]:BB:MCCW:CARRier:STATe <CarrierIndex>, <State>**

Switches the selected carrier on or off.

**Parameters:**

<CarrierIndex> integer  
 Range: 0 to lastCarrier  
 <State> 1 | ON | 0 | OFF  
 \*RST: 0

**Example:** See "[Programming examples](#)" on page 1149

**Manual operation:** See "[Carrier Table](#)" on page 414

**[:SOURce<hw>]:BB:MCCW:CARRier:LIST:STATe <Stat0[,Stat1..]>**  
**[:SOURce<hw>]:BB:MCCW:CARRier:LIST:STATe? <Start>, <Count>**

Switches the carrier on or off with the aid of a value list.

The first value in the list is assigned to the carrier with index 0, the second value to the carrier with index 1, etc. The maximum length corresponds to the maximum number of multi carriers. There is no need to enter all the values every time. Values not set by the value list are set with the default values provided they have already been explicitly set by a previous command. If this is the case, the values continue to apply until overwritten.

**Setting parameters:**

<Stat0[,Stat1..]> ON | OFF

**Query parameters:**

<Start> integer  
 start carrier index  
 Range: 0 to lastCarrier  
 <Count> integer  
 number of carriers in the carrier range, starting from the  
 <Start> carrier  
 Range: 1 to lastCarrier

**Return values:**

<State[,State..]> select

**Example:** See ["Programming examples"](#) on page 1149

**Manual operation:** See ["Carrier Table"](#) on page 414

**[[:SOURce<hw>]:BB:MCCW:CARRier:PHASe <CarrierIndex>, <Phase>**

For disabled optimization of the crest factor, sets the start phase of the selected carrier.

**Parameters:**

<CarrierIndex> integer  
 Range: 0 to lastCarrier

<Phase> float  
 Range: 0 to 359.99  
 Increment: 0.01  
 \*RST: 0  
 Default unit: DEG

**Example:** see ["Programming examples"](#) on page 1149

**Manual operation:** See ["Carrier Table"](#) on page 414

**[[:SOURce<hw>]:BB:MCCW:CARRier:LIST:PHASe <Phas0[,Phas1..]>**

**[[:SOURce<hw>]:BB:MCCW:CARRier:LIST:PHASe? [<Start>[, <Count>]]**

Sets the start phase of the carrier with the aid of a value list.

**Setting parameters:**

<Phas0[,Phas1..]> float  
 Range: 0 to 360  
 Increment: 0.01  
 \*RST: 0  
 Default unit: DEG

**Query parameters:**

<Start> integer  
 start carrier index  
 Range: 0 to lastCarrier

<Count> integer  
 number of carriers in the carrier range, starting from the  
 <Start> carrier  
 Range: 1 to max

**Return values:**

<Phas[,Phas..]> float

**Example:** see ["Programming examples"](#) on page 1149

**Manual operation:** See ["Carrier Table"](#) on page 414

---

```
[:SOURce<hw>]:BB:MCCW:CARRier:POWer <CarrierIndex>, <Power>
```

Sets the power of the selected carrier.

**Parameters:**

<b>&lt;CarrierIndex&gt;</b>	integer
	Range: 0 to lastCarrier
<b>&lt;Power&gt;</b>	float
	Range: -80 to 0
	Increment: 0.01
	*RST: 0

**Example:** see ["Programming examples"](#) on page 1149

**Manual operation:** See ["Carrier Table"](#) on page 414

---

```
[:SOURce<hw>]:BB:MCCW:CARRier:LIST:POWer <Pow0[,Pow1..]>  
[:SOURce<hw>]:BB:MCCW:CARRier:LIST:POWer? <Start>, <Count>
```

Sets the power of the carrier with the aid of a value list.

**Setting parameters:**

<b>&lt;Pow0[,Pow1..]&gt;</b>	float
	Increment: 0.01
	*RST: 0 dB

**Query parameters:**

<b>&lt;Start&gt;</b>	integer
	start carrier index
	Range: 0 to lastCarrier
<b>&lt;Count&gt;</b>	integer
	number of carriers in the carrier range, starting from the <Start> carrier
	Range: 1 to lastCarrier

**Return values:**

<b>&lt;Pow[,Pow..]&gt;</b>	float
----------------------------	-------

**Example:** see ["Programming examples"](#) on page 1149

**Manual operation:** See ["Carrier Table"](#) on page 414

---

```
[:SOURce<hw>]:BB:MCCW:EDIT:CARRier:PHASe[:START] <Start>  
[:SOURce<hw>]:BB:MCCW:EDIT:CARRier:POWer[:START] <Start>
```

Sets the power/pahse for the starting carrier. The power of the remaining carriers is stepped up or down by the power specified with the [\[:SOURce<hw>\]:BB:MCCW:EDIT:CARRier:POWer:STEP](#) command.

**Parameters:**

<Start> float  
 Range: -80 to 0  
 Increment: 0.01  
 \*RST: 0

**Example:** see ["Programming examples"](#) on page 1149

**Manual operation:** See ["Power Start"](#) on page 413

**[:SOURce<hw>]:BB:MCCW:EDIT:CARRier:PHASe:STEP <Step>**

For disabled optimization of the crest factor, sets the step width by which the start phase of the carriers in the defined carrier range is incremented.

**Parameters:**

<Step> float  
 Range: -359.99 to 359.99  
 Increment: 0.01  
 \*RST: 0

**Example:** See ["Programming examples"](#) on page 1149

**Manual operation:** See ["Phase Step"](#) on page 413

**[:SOURce<hw>]:BB:MCCW:EDIT:CARRier:POWER:STEP <Step>**

Sets the step width by which the starting power of the carriers in the defined carrier range is incremented.

**Parameters:**

<Step> float  
 Range: -80 to 80  
 Increment: 0.01  
 \*RST: 0

**Example:** See ["Programming examples"](#) on page 1149

**Manual operation:** See ["Power Step"](#) on page 413

**[:SOURce<hw>]:BB:MCCW:EDIT:CARRier:START <Start>****[:SOURce<hw>]:BB:MCCW:EDIT:CARRier:STOP <Stop>**

Defines the first/last carrier in the carrier range to which joint configuration applies.

**Parameters:**

<Stop> integer  
 Range: 0 to 8191  
 \*RST: 0

**Example:** See ["Programming examples"](#) on page 1149

**Manual operation:** See ["Carrier Start/Stop"](#) on page 413



---

**[[:SOURce<hw>]:BB:MCCW:EDIT:CARRIER:STATE <State>**

Switches all the carriers in the selected carrier range on or off.

**Parameters:**

<State>                    1 | ON | 0 | OFF  
 \*RST:                    1

**Example:**                See "Programming examples" on page 1149

**Manual operation:**    See "Carrier State" on page 413

---

**[[:SOURce<hw>]:BB:MCCW:EDIT:CARRIER:EXECute**

Adopts the settings for the carrier range.

**Example:**                See "Programming examples" on page 1149

**Usage:**                    Event

**Manual operation:**    See "Accept" on page 414

---

**Trigger commands**

[[:SOURce<hw>]:BB:MCCW[:TRIGger]:SEQuence.....	1161
[[:SOURce<hw>]:BB:MCCW:TRIGger:SOURce.....	1162
[[:SOURce<hw>]:BB:MCCW:TRIGger:RMODE?.....	1162
[[:SOURce<hw>]:BB:MCCW:TRIGger:TIME:DATE.....	1163
[[:SOURce<hw>]:BB:MCCW:TRIGger:TIME:TIME.....	1163
[[:SOURce<hw>]:BB:MCCW:TRIGger:TIME[:STATE].....	1164
[[:SOURce<hw>]:BB:MCCW:TRIGger:SLENGth.....	1164
[[:SOURce<hw>]:BB:MCCW:TRIGger:ARM:EXECute.....	1164
[[:SOURce<hw>]:BB:MCCW:TRIGger:EXECute.....	1164
[[:SOURce<hw>]:BB:MCCW:TRIGger:EXTErnal:SYNChronize:OUTPut.....	1165
[[:SOURce<hw>]:BB:MCCW:TRIGger:OBASeband:DELAy.....	1165
[[:SOURce<hw>]:BB:MCCW:TRIGger:OBASeband:INHibit.....	1165
[[:SOURce<hw>]:BB:MCCW:TRIGger[:EXTErnal<ch>]:DELAy.....	1165
[[:SOURce<hw>]:BB:MCCW:TRIGger[:EXTErnal<ch>]:INHibit.....	1166

---

**[[:SOURce<hw>]:BB:MCCW[:TRIGger]:SEQuence <Sequence>**

Selects the trigger mode.

See also "About trigger modes" on page 237.

**Parameters:**

<Sequence>                AUTO | RETRigger | AAUTo | ARETrigger | SINGle  
 \*RST:                    AUTO

**Example:**                See "Programming examples" on page 1149

**Manual operation:**    See "Mode" on page 253

**[:SOURce<hw>]:BB:MCCW:TRIGger:SOURce <Source>**

Selects the trigger signal source and determines the way the triggering is executed. Provided are the following trigger sources:

- INTernal: Internal manual triggering of the instrument
- INTA|INTB: Internal triggering by a signal from the other basebands
- External trigger signal via one of the local or global connectors:
  - EGT1|EGT2: External global trigger
  - EGC1|EGC2: External global clock
  - ELTRigger: External local trigger
  - ELCLock: External local clock
- For secondary instruments (SCONfiguration:MULTIinstrument:MODE SEC), triggering via the external baseband synchronization signal of the primary instrument:  
SOURcel:BB:ARB:TRIGger:SOURce BBSY
- OBASeband|BEXTernal|EXTernal: **Setting only**  
Provided only for backward compatibility with other Rohde & Schwarz signal generators. The R&S SMW200A accepts these values and maps them automatically as follows:  
EXTernal = EGT1, BEXTernal = EGT2, OBASeband = INTA or INTB  
(depending on the current baseband)

**Parameters:**

<Source> INTB|INTernal|OBASeband|EGT1|EGT2|EGC1|EGC2|ELTRigger|INTA|ELCLock|BEXTernal|EXTernal | BBSY  
\*RST: INTernal

**Example:** See "[Programming examples](#)" on page 1149

**Options:** ELTRigger|ELCLock require R&S SMW-B10  
BBSY require R&S SMW-B9

**Manual operation:** See "[Source](#)" on page 255

**[:SOURce<hw>]:BB:MCCW:TRIGger:RMODe?**

Queries the status of signal generation for all trigger mode, if multi-carrier CW generation is on.

**Return values:**

<RMode> STOP | RUN

**Example:** See "[Programming examples](#)" on page 1149

**Usage:** Query only

**Manual operation:** See "[Running/Stopped](#)" on page 254

---

**[:SOURce<hw>]:BB:MCCW:TRIGger:TIME:DATE** <Year>, <Month>, <Day>

Sets the date for a time-based trigger signal. For trigger modes single or armed auto, you can activate triggering at this date via the following command:

SOURce<hw>:BB:<DigStd>:TRIGger:TIME:STATe

<DigStd> is the mnemonic for the digital standard, for example, ARB. Time-based triggering behaves analogously for all digital standards that support this feature.

**Parameters:**

<Year>	integer	
	Range:	1980 to 9999
<Month>	integer	
	Range:	1 to 12
<Day>	integer	
	Range:	1 to 31

**Example:** See [Example "Configure a time-based trigger signal"](#) on page 1137.

**Manual operation:** See ["Trigger Time"](#) on page 254

---

**[:SOURce<hw>]:BB:MCCW:TRIGger:TIME:TIME** <Hour>, <Minute>, <Second>

Sets the time for a time-based trigger signal. For trigger modes single or armed auto, you can activate triggering at this time via the following command:

SOURce<hw>:BB:<DigStd>:TRIGger:TIME:STATe

<DigStd> is the mnemonic for the digital standard, for example, ARB. Time-based triggering behaves analogously for all digital standards that support this feature.

**Parameters:**

<Hour>	integer	
	Range:	0 to 23
<Minute>	integer	
	Range:	0 to 59
<Second>	integer	
	Range:	0 to 59

**Example:** See [Example "Configure a time-based trigger signal"](#) on page 1137.

**Manual operation:** See ["Trigger Time"](#) on page 254

---

**[[:SOURce<hw>]:BB:MCCW:TRIGger:TIME[:STATe] <State>**

Activates time-based triggering with a fixed time reference. If activated, the R&S SMW200A triggers signal generation when its operating system time matches a specified time.

Specify the trigger date and trigger time with the following commands:

```
SOURce<hw>:BB:<DigStd>:TRIGger:TIME:DATE
```

```
SOURce<hw>:BB:<DigStd>:TRIGger:TIME:TIME
```

<DigStd> is the mnemonic for the digital standard, for example, ARB. Time-based triggering behaves analogously for all digital standards that support this feature.

**Parameters:**

<State>                    1 | ON | 0 | OFF  
\*RST:                    0

**Example:**                See [Example "Configure a time-based trigger signal"](#) on page 1137.

**Manual operation:**    See ["Time Based Trigger"](#) on page 254

---

**[[:SOURce<hw>]:BB:MCCW:TRIGger:SLENGth <SLength>**

Defines the length of the signal sequence to be output in the "Single" trigger mode.

**Parameters:**

<SLength>                integer  
Range:                    1 to 1000  
\*RST:                    1  
Default unit: samples

**Example:**                See ["Programming examples"](#) on page 1149

**Manual operation:**    See ["Signal Duration"](#) on page 257

---

**[[:SOURce<hw>]:BB:MCCW:TRIGger:ARM:EXECute**

Stops signal generation.

**Example:**                See ["Programming examples"](#) on page 1149

**Usage:**                    Event

**Manual operation:**    See ["Arm"](#) on page 255

---

**[[:SOURce<hw>]:BB:MCCW:TRIGger:EXECute**

Executes a trigger.

**Example:**                See ["Programming examples"](#) on page 1149

**Usage:**                    Event

**Manual operation:** See ["Execute Trigger"](#) on page 255

---

**[[:SOURce<hw>]:BB:MCCW:TRIGger:EXTernal:SYNChronize:OUTPut <Output>**

Enables signal output synchronous to the trigger event.

**Parameters:**

<Output> 1 | ON | 0 | OFF  
\*RST: 1

**Example:** See ["Programming examples"](#) on page 1149

**Manual operation:** See ["Sync. Output to Ext. Trigger/Sync. Output to Trigger"](#) on page 256

---

**[[:SOURce<hw>]:BB:MCCW:TRIGger:OBASeband:DELay <Delay>**

Specifies the trigger delay for external triggering.

**Parameters:**

<Delay> float  
Range: 0 to 2147483647  
Increment: 0.01  
\*RST: 0  
Default unit: samples

**Example:** See ["Programming examples"](#) on page 1149

**Manual operation:** See ["\(Specified\) External Delay/\(Specified\) Trigger Delay"](#) on page 257

---

**[[:SOURce<hw>]:BB:MCCW:TRIGger:OBASeband:INHibit <Inhibit>**

Specifies the number of samples by which a restart is inhibited following a trigger event from the other path.

**Parameters:**

<Inhibit> integer  
Range: 0 to 67108863  
\*RST: 0

**Example:** See ["Programming examples"](#) on page 1149

**Manual operation:** See ["External Inhibit/Trigger Inhibit"](#) on page 256

---

**[[:SOURce<hw>]:BB:MCCW:TRIGger[:EXTernal<ch>]:DELay <Delay>**

Specifies the trigger delay in samples.

Maximum trigger delay and trigger inhibit values depend on the installed options. See ["To set delay and inhibit values"](#) on page 242.

**Parameters:**

<Delay> float  
 Range: 0 to 2147483647  
 Increment: 0.01  
 \*RST: 0  
 Default unit: samples  
 E.g. 0 to 2147483647 samples (R&S SMW-B10)

**Example:** See "[Programming examples](#)" on page 1149.

**Manual operation:** See "[\(Specified\) External Delay/\(Specified\) Trigger Delay](#)" on page 257

**[:SOURce<hw>]:BB:MCCW:TRIGger[:EXternal<ch>]:INHibit <Inhibit>**

Specifies the number of samples, by which a restart is inhibited following an external trigger event.

Maximum trigger delay and trigger inhibit values depend on the installed options. See "[To set delay and inhibit values](#)" on page 242.

**Parameters:**

<Inhibit> integer  
 Range: 0 to 21.47 \* (clock frequency)  
 \*RST: 0  
 Default unit: sample  
 E.g. 0 to 2147483647 samples (R&S SMW-B10)

**Example:** See "[Programming examples](#)" on page 1149

**Manual operation:** See "[External Inhibit/Trigger Inhibit](#)" on page 256

**Marker commands**

<a href="#">[:SOURce&lt;hw&gt;]:BB:MCCW:TRIGger:OUTPut&lt;ch&gt;:MODE</a> .....	1166
<a href="#">[:SOURce&lt;hw&gt;]:BB:MCCW:TRIGger:OUTPut&lt;ch&gt;:ONTime</a> .....	1167
<a href="#">[:SOURce&lt;hw&gt;]:BB:MCCW:TRIGger:OUTPut&lt;ch&gt;:OFFTime</a> .....	1167
<a href="#">[:SOURce&lt;hw&gt;]:BB:MCCW:TRIGger:OUTPut&lt;ch&gt;:PATtern</a> .....	1167
<a href="#">[:SOURce&lt;hw&gt;]:BB:MCCW:TRIGger:OUTPut&lt;ch&gt;:PULSe:DIVider</a> .....	1167
<a href="#">[:SOURce&lt;hw&gt;]:BB:MCCW:TRIGger:OUTPut&lt;ch&gt;:PULSe:FREQuency?</a> .....	1168
<a href="#">[:SOURce&lt;hw&gt;]:BB:MCCW:TRIGger:OUTPut&lt;ch&gt;:DELay</a> .....	1168

**[:SOURce<hw>]:BB:MCCW:TRIGger:OUTPut<ch>:MODE <Mode>**

Defines the signal for the selected marker output. For detailed description of the regular marker modes, refer to "[Marker modes](#)" on page 232.

**Parameters:**

<Mode> REStart | PULSe | PATtern | RATio  
 \*RST: REStart

**Example:** See "[Programming examples](#)" on page 1149

**Manual operation:** See ["Mode"](#) on page 259

---

```
[ :SOURce<hw>]:BB:MCCW:TRIGger:OUTPut<ch>:ONTime <OnTime>
[:SOURce<hw>]:BB:MCCW:TRIGger:OUTPut<ch>:OFFTime <OffTime>
```

Sets the number of samples in the off period of the corresponding marker signal.

\*) If R&S SMW-B9 is installed, the minimum marker duration depends on the sample/symbol rate.

See ["Marker minimum duration"](#) on page 234.

**Parameters:**

<OffTime> integer  
 Range: 1 (R&S SMW-B10) / 1\* (R&S SMW-B9) to 16777215  
 \*RST: 1

**Example:** see ["Programming examples"](#) on page 1149

**Manual operation:** See ["Mode"](#) on page 259

---

```
[ :SOURce<hw>]:BB:MCCW:TRIGger:OUTPut<ch>:PATTern <Pattern>, <BitCount>
```

Defines the bit pattern used to generate the marker signal.

**Parameters:**

<Pattern> numeric  
 \*RST: #H2

<BitCount> integer  
 0 = marker off, 1 = marker on  
 Range: 1 to 64  
 \*RST: 2

**Example:** See ["Programming examples"](#) on page 1149.

**Manual operation:** See ["Mode"](#) on page 259

---

```
[ :SOURce<hw>]:BB:MCCW:TRIGger:OUTPut<ch>:PULSe:DIVider <Divider>
```

Sets the divider for pulse marker mode.

\*) If R&S SMW-B9 is installed, the minimum marker duration depends on the sample/symbol rate.

See ["Marker minimum duration"](#) on page 234.

**Parameters:**

<Divider> integer  
 Range: 2 (R&S SMW-B10) / 2\* (R&S SMW-B9) to 1024  
 \*RST: 2

**Example:** See ["Programming examples"](#) on page 1149

**Manual operation:** See "Mode" on page 259

---

**[:SOURce<hw>]:BB:MCCW:TRIGger:OUTPut<ch>:PULSe:FREQuency?**

Queries the pulse frequency of the pulsed marker signal.

**Return values:**

<Frequency> float  
Increment: 1E-3

**Example:** see "Programming examples" on page 1149

**Usage:** Query only

**Manual operation:** See "Mode" on page 259

---

**[:SOURce<hw>]:BB:MCCW:TRIGger:OUTPut<ch>:DELay <Delay>**

Defines the delay between the signal on the marker outputs and the start of the signals, expressed as number of samples.

**Parameters:**

<Delay> float  
Range: 0 to 16777215  
Increment: 0.001  
\*RST: 0

**Example:** See "Programming examples" on page 1149.

**Manual operation:** See "Delay" on page 259

**Clock commands**

[\[:SOURce<hw>\]:BB:MCCW:CLOCK:SOURce.....](#) 1168  
[\[:SOURce<hw>\]:BB:MCCW:CLOCK:MODE.....](#) 1169

---

**[:SOURce<hw>]:BB:MCCW:CLOCK:SOURce <Source>**

Selects the clock source:

- INTernal: Internal clock reference
- ELCLock: External local clock
- EXTernal = ELCLock: Setting only  
Provided for backward compatibility with other Rohde & Schwarz signal generators

**Parameters:**

<Source> INTernal|ELCLock|EXTernal  
\*RST: INTernal

**Example:** See "Programming examples" on page 1149.

**Options:** ELCLock requires R&S SMW-B10

**Manual operation:** See "Clock Source" on page 260



**[[:SOURce<hw>]:BB:MCCW:CLOCK:MODE <Mode>**

Sets the type of externally supplied clock.

**Parameters:**

<Mode>                    SAMPlE  
                              \*RST:            SAMPlE

**Example:**                See "Programming examples" on page 1149.

**Options:**                R&S SMW-B10

**Manual operation:**    See "Clock Mode" on page 260

#### 14.19.5.5 SOURce:BB:IMPairment subsystem

This subsystem contains the commands for the analog and digital I/Q impairments.

**Suffixes**

Suffix	Value range	Description
RF<ch>	1 to 2	Digital impairments for RF connector
IQOutput<ch>	1 to 2	IQ connector
BBMM<ch>	1 to 2	DIG IQ connector
FADer<ch>	1 to 4	DIG IQ connector

**Required options**

See [Section 6.4.1, "Required options"](#), on page 449.

**Commands:**

[[:SOURce]:BB:IMPairment:BBMM<ch>:DELay.....	1170
[[:SOURce]:BB:IMPairment:FADer<ch>:DELay.....	1170
[[:SOURce]:BB:IMPairment:IQOutput<ch>:DELay.....	1170
[[:SOURce]:BB:IMPairment:RF<ch>:DELay.....	1170
[[:SOURce<hw>]:IQ:IMPairment:IQRatio[:MAGNitude].....	1171
[[:SOURce]:BB:IMPairment:BBMM<ch>:IQRatio[:MAGNitude].....	1171
[[:SOURce]:BB:IMPairment:FADer<ch>:IQRatio[:MAGNitude].....	1171
[[:SOURce]:BB:IMPairment:IQOutput<ch>:IQRatio[:MAGNitude].....	1171
[[:SOURce]:BB:IMPairment:RF<ch>:IQRatio[:MAGNitude].....	1171
[[:SOURce<hw>]:IQ:IMPairment:LEAKage:I.....	1171
[[:SOURce<hw>]:IQ:IMPairment:LEAKage:Q.....	1171
[[:SOURce]:BB:IMPairment:BBMM<ch>:LEAKage:I.....	1171
[[:SOURce]:BB:IMPairment:BBMM<ch>:LEAKage:Q.....	1171
[[:SOURce]:BB:IMPairment:FADer<ch>:LEAKage:I.....	1171
[[:SOURce]:BB:IMPairment:FADer<ch>:LEAKage:Q.....	1171
[[:SOURce]:BB:IMPairment:IQOutput<ch>:LEAKage:I.....	1171
[[:SOURce]:BB:IMPairment:IQOutput<ch>:LEAKage:Q.....	1171
[[:SOURce]:BB:IMPairment:RF<ch>:LEAKage:I.....	1171

<code>[:SOURce]:BB:IMPairment:RF&lt;ch&gt;:LEAKage:Q.....</code>	1171
<code>[:SOURce&lt;hw&gt;]:IQ:IMPairment:QUADrature[:ANGLE].....</code>	1172
<code>[:SOURce]:BB:IMPairment:BBMM&lt;ch&gt;:QUADrature[:ANGLE].....</code>	1172
<code>[:SOURce]:BB:IMPairment:FADer&lt;ch&gt;:QUADrature[:ANGLE].....</code>	1172
<code>[:SOURce]:BB:IMPairment:IQOutput&lt;ch&gt;:QUADrature[:ANGLE].....</code>	1172
<code>[:SOURce]:BB:IMPairment:RF&lt;ch&gt;:QUADrature[:ANGLE].....</code>	1172
<code>[:SOURce]:BB:IMPairment:BBMM&lt;ch&gt;:SKEW.....</code>	1172
<code>[:SOURce]:BB:IMPairment:FADer&lt;ch&gt;:SKEW.....</code>	1172
<code>[:SOURce]:BB:IMPairment:IQOutput&lt;ch&gt;:SKEW.....</code>	1172
<code>[:SOURce]:BB:IMPairment:RF&lt;ch&gt;:SKEW.....</code>	1172
<code>[:SOURce&lt;hw&gt;]:IQ:IMPairment[:STATE].....</code>	1172
<code>[:SOURce]:BB:IMPairment:BBMM&lt;ch&gt;:STATE.....</code>	1172
<code>[:SOURce]:BB:IMPairment:FADer&lt;ch&gt;:STATE.....</code>	1173
<code>[:SOURce]:BB:IMPairment:IQOutput&lt;ch&gt;:STATE.....</code>	1173
<code>[:SOURce]:BB:IMPairment:RF&lt;ch&gt;:STATE.....</code>	1173
<code>[:SOURce]:BB:IMPairment:BBMM&lt;ch&gt;:POFFset.....</code>	1173
<code>[:SOURce]:BB:IMPairment:FADer&lt;ch&gt;:POFFset.....</code>	1173
<code>[:SOURce]:BB:IMPairment:IQOutput&lt;ch&gt;:POFFset.....</code>	1173
<code>[:SOURce]:BB:IMPairment:RF&lt;ch&gt;:POFFset.....</code>	1173
<code>[:SOURce&lt;hw&gt;]:BB:IMPairment:OPTimization:MODE.....</code>	1173

`[:SOURce]:BB:IMPairment:BBMM<ch>:DELay <Delay>`

`[:SOURce]:BB:IMPairment:FADer<ch>:DELay <Delay>`

`[:SOURce]:BB:IMPairment:IQOutput<ch>:DELay <Delay>`

`[:SOURce]:BB:IMPairment:RF<ch>:DELay <Delay>`

Defines the time delay of both I and Q vectors between the marker signal at the marker outputs relative to the signal generation start.

A positive value means that the I and Q vectors delay relative to the marker/trigger and vice versa.

**Table 14-7: Value range**

Output	Min /s	Max /s	Increment
RF<ch>	0	10E-6	1E-12
FADer<ch>	0	500E-9	1E-12
IQOutput<ch>	-500E-9	500E-9	1E-12
BBMM<ch>	-500E-9	500E-9	1E-12

**Parameters:**

<Delay>

float

Range: 0 to 10E-6

Increment: 1E-12

\*RST: 0

**Example:**

`SOURce1:BB:IMPairment:RF1:DELay 32.0E-9`

**Manual operation:**

See "IQ Delay" on page 456

```
[:SOURce<hw>]:IQ:IMPairment:IQRatio[:MAGNitude] <Magnitude>
[:SOURce]:BB:IMPairment:BBMM<ch>:IQRatio[:MAGNitude] <IqRatio>
[:SOURce]:BB:IMPairment:FADer<ch>:IQRatio[:MAGNitude] <IqRatio>
[:SOURce]:BB:IMPairment:IQOutput<ch>:IQRatio[:MAGNitude] <IqRatio>
[:SOURce]:BB:IMPairment:RF<ch>:IQRatio[:MAGNitude] <IqRatio>
```

Sets the ratio of I modulation to Q modulation (amplification imbalance) of the corresponding digital channel.

Table 14-8: Value range

Impairments	Min /dB	Max /dB	Increment
Digital	-4	4	0.0001
Analog	-1	1	0.0001

**Parameters:**

<IqRatio>

float

The setting value can be either in dB or %. An input in percent is rounded to the closest valid value in dB.

Range: -4 to 4

Increment: 1E-4

\*RST: 0

Default unit: dB | PCT (setting command) / dB (result value)

**Example:**

```
SOURce:BB:IMPairment:RF1:IQRatio:MAGNitude 10 PCT
SOURce:BB:IMPairment:RF1:IQRatio:MAGNitude?
// 0.848
// the value is returned in dB
```

**Manual operation:** See "[Gain Imbalance](#)" on page 454

```
[:SOURce<hw>]:IQ:IMPairment:LEAKage:I <I>
[:SOURce<hw>]:IQ:IMPairment:LEAKage:Q <Q>
[:SOURce]:BB:IMPairment:BBMM<ch>:LEAKage:I <I>
[:SOURce]:BB:IMPairment:BBMM<ch>:LEAKage:Q <Q>
[:SOURce]:BB:IMPairment:FADer<ch>:LEAKage:I <I>
[:SOURce]:BB:IMPairment:FADer<ch>:LEAKage:Q <Q>
[:SOURce]:BB:IMPairment:IQOutput<ch>:LEAKage:I <I>
[:SOURce]:BB:IMPairment:IQOutput<ch>:LEAKage:Q <Q>
[:SOURce]:BB:IMPairment:RF<ch>:LEAKage:I <I>
[:SOURce]:BB:IMPairment:RF<ch>:LEAKage:Q <Q>
```

Determines the leakage amplitude of the I or Q signal component of the corresponding stream

**Parameters:**

<Q>

float

Range: -10 to 10

Increment: 0.01

\*RST: 0

**Example:** `SOURce:BB:IMPairment:RF1:LEAKage:Q 4 PCT`  
Sets the leakage for the Q-component to 4 percent.

**Manual operation:** See "[I Offset/Q Offset](#)" on page 454

```
[:SOURce<hw>]:IQ:IMPairment:QUADrature[:ANGLE] <Angle>
[:SOURce]:BB:IMPairment:BBMM<ch>:QUADrature[:ANGLE] <Angle>
[:SOURce]:BB:IMPairment:FADer<ch>:QUADrature[:ANGLE] <Angle>
[:SOURce]:BB:IMPairment:IQOutput<ch>:QUADrature[:ANGLE] <Angle>
[:SOURce]:BB:IMPairment:RF<ch>:QUADrature[:ANGLE] <Angle>
```

Sets a quadrature offset (phase angle) between the I and Q vectors deviating from the ideal 90 degrees.

A positive quadrature offset results in a phase angle greater than 90 degrees.

*Table 14-9: Value range*

Impairments	Min /dB	Max /dB	Increment
Digital	-30	30	0.01
Analog	-10	10	0.01

**Parameters:**

<Angle> float  
Range: -30 to 30  
Increment: 0.01  
\*RST: 0  
Default unit: DEG

**Example:** `SOURce:BB:IMPairment:RF1:QUADrature:ANGLE -5`  
Sets the quadrature offset to -5 degrees.

**Manual operation:** See "[Quadrature Offset](#)" on page 455

```
[:SOURce]:BB:IMPairment:BBMM<ch>:SKEW <Skew>
[:SOURce]:BB:IMPairment:FADer<ch>:SKEW <Skew>
[:SOURce]:BB:IMPairment:IQOutput<ch>:SKEW <Skew>
[:SOURce]:BB:IMPairment:RF<ch>:SKEW <Skew>
```

Sets a delay between the Q vector and the I vector of the corresponding stream.

**Parameters:**

<Skew> float  
Range: -500E-9 to 500E-9  
Increment: 1E-12  
\*RST: 0

**Manual operation:** See "[Skew](#)" on page 455

```
[:SOURce<hw>]:IQ:IMPairment[:STATe] <State>
[:SOURce]:BB:IMPairment:BBMM<ch>:STATe <State>
```

```
[:SOURce]:BB:IMPairment:FADer<ch>:STATe <State>
[:SOURce]:BB:IMPairment:IQOutput<ch>:STATe <State>
[:SOURce]:BB:IMPairment:RF<ch>:STATe <State>
```

Activates the impairment or correction values LEAKage, QUADrature and IQRatio for the corresponding stream.

**Parameters:**

```
<State>          1 | ON | 0 | OFF
*RST:           0
```

**Example:**

```
SOURce1:BB:IMPairment:RF1:STATe ON
Activates digital impairment.
```

**Manual operation:** See "State" on page 454

```
[:SOURce]:BB:IMPairment:BBMM<ch>:POFFset <PhaseOffset>
[:SOURce]:BB:IMPairment:FADer<ch>:POFFset <PhaseOffset>
[:SOURce]:BB:IMPairment:IQOutput<ch>:POFFset <PhaseOffset>
[:SOURce]:BB:IMPairment:RF<ch>:POFFset <PhaseOffset>
```

Adds an additional phase offset after the stream mapper.

You can shift the phase at the different stages in the signal generation flow, see:

- [\[:SOURce<hw>\]:BB:POFFset](#) on page 1058
- [:SCONfiguration:OUTPut:MAPPING:STReam<st>:POFFset](#) on page 982

**Parameters:**

```
<PhaseOffset>  float
                Range:    -999.99 to 999.99
                Increment: 0.01
                *RST:     0
```

**Example:**

```
SOURce:BB:IMPairment:RF1:POFFset 0
```

**Manual operation:** See "Phase Offset" on page 456

```
[:SOURce<hw>]:BB:IMPairment:OPTimization:MODE <Mode>
```

Sets the optimization mode for I/Q modulation.

If equipped with option R&S SMW-K544, the optimization mode applies for the I/Q modulation performance and for the user-defined frequency response corrections.

See the user manual "R&S SMW-K544 User-Defined Frequency Response Correction".

**Parameters:**

```
<Mode>          FAST | | QHIGH | QHTable
```

**FAST**

Fast optimization with high switching speed by compensating for I/Q skew. This mode is suitable in time sensitive environments and for narrowband signals.

**QHIGh**

Optimization by compensating for I/Q skew and frequency response correction.

This mode interrupts the RF signal generation. Do not use it in combination with the uninterrupted level settings and strictly monotone modes RF level modes.

See [:SOURce<hw>]:POWer:LBEHaviour on page 1271.

**QHTable**

Improves the frequency response while maintaining setting time, there is no signal interruption.

\*RST: FAST

\*RST: FAST for R&S SMW-B10) / QHIGh for R&S SMW-B9 / QHTable if the R&S SMW200A generates upconverted I/Q signal with a connected R&S SZU connected.

**Example:**

```
:SOURce1:IQ:SOURce?
// Response: "BASEband"
// The I/Q signal source is the internal baseband signal.
:SOURce1:BB:IMPairment:OPTimization:MODE FAST
```

**Manual operation:** See "Optimization Mode" on page 470

**14.19.5.6 SOURce:BB:GRAPhics subsystem**

This subsystem contains the commands used to setup the graphical display.

**Required options**

See Section 9.1.1, "Required options", on page 622.

[:SOURce<hw>]:BB:GRAPhics:MODE.....	1174
[:SOURce<hw>]:BB:GRAPhics:SRATe:MODE.....	1175
[:SOURce<hw>]:BB:GRAPhics:SRATe:USER.....	1175
[:SOURce]:BB:GRAPhics:CLOSe.....	1175
[:SOURce]:BB:GRAPhics:ADD.....	1176
[:SOURce]:BB:GRAPhics:SOURce.....	1176
[:SOURce]:BB:GRAPhics:SOURce:MUX.....	1176
[:SOURce]:BB:GRAPhics:FFTLen.....	1177
[:SOURce]:BB:GRAPhics:FFTFscale.....	1177
[:SOURce<hw>]:BB:GRAPhics:TRIGger:SOURce.....	1177

---

**[:SOURce<hw>]:BB:GRAPhics:MODE <Mode>**

Sets the graphics mode of the graphical signal display.

**Parameters:**

<Mode> | IQ | VECTor | CCDF | PSPectrum | CONStellation | EYEI | EYEQ

\*RST: IQ

**Example:** `BB:GRAP:MODE PSP`  
Sets the power spectrum graphics mode.

**Manual operation:** See ["Mode"](#) on page 631

**[:SOURce<hw>]:BB:GRAPhics:SRATe:MODE <Mode>**

Sets how the time resolution of the signal is determined. Maximum resolution corresponds to a diagram covering the entire signal bandwidth. The higher the resolution is, the shorter the length of the displayed signal segment will be for the specified recording depth.

**Parameters:**  
<Mode> AUTO | FULL | USER  
\*RST: AUTO

**Example:** `BB:GRAP:SRAT:MODE FULL`  
Sets the sample rate mode.

**Manual operation:** See ["Sample Rate Mode"](#) on page 632

**[:SOURce<hw>]:BB:GRAPhics:SRATe:USER <User>**

(Enabled for `BB:GRAPH:SRAT:MODE USER`)

Selects the signal bandwidth for the diagram. The setting range moves between the minimum and maximum bandwidth which is possible for the selected graphical signal display. The selection is made graphically by moving the pointer.

**Parameters:**  
<User> float  
Range: 0.01 to 100  
Increment: 0.01  
\*RST: 10  
Default unit: PCT

**Example:** `BB:GRAP:SRAT:USER 20`  
sets the sample rate factor.

**Example:** `BB:GRAP:SRAT:MODE USER`  
sets the sample rate mode.

**Manual operation:** See ["Sample Rate"](#) on page 633

**[:SOURce]:BB:GRAPhics:CLOSe**

Closes all graphical signal displays.

**Usage:** Event

**Manual operation:** See ["Remove"](#) on page 633

---

**[[:SOURce]:BB:GRAPhics:ADD <Size>**

Adds a graphical signal display (according to the current `MODE`, `SOURce`, `SRATe:*` and `TRIGger:*` settings).

**Setting parameters:**

<Size>                    MAXimized | MINimized

**Usage:**                    Setting only

**Manual operation:**    See "[Add](#)" on page 633

---

**[[:SOURce]:BB:GRAPhics:SOURce <Source>**

Defines the signal acquisition point, that is the location in the signal flow where the displayed signal is tapped from.

The available acquisition points depend on the selected system configuration.

**Parameters:**

<Source>                    | STRA | STRB | STRC | STRD | STRE | STRF | STRG | STRH |  
BBA | BBB | BBC | BBD | BBE | BBF | BBG | BBH | RFA | RFB |  
RFC | RFD | IQO1 | IQO2 | DO1 | DO2

**STRA|STRB|STRC|STRD|STRE|STRF|STRG|STRH**

Streams (A to H); input stream of the "IQ Stream Mapper"

**BBA|BBB|BBC|BBD|BBE|BBF|BBG|BBH**

Baseband signals (A to H)

**BBIA|BBIB**

Digital baseband input signals

**RFA|RFB|RFC|RFD**

RF signals (A to D)

**IQO1|IQO2**

Analog I/Q output signals

**DO1|DO2**

Digital I/Q output signals; outputs of the "IQ Stream Mapper"

\*RST:                    STRA

**Manual operation:**    See "[Source](#)" on page 631

Location and use of the source types is shown in [Section 9.1.2.2, "Signal acquisition points"](#), on page 627.

---

**[[:SOURce]:BB:GRAPhics:SOURce:MUX <Mode>**

In `:SCONfiguration:OUTPut:MODE DIGMux` mode, select which of the multiplexed streams is displayed.

**Parameters:**

<Mode>                    STRA | STRB | STRC | STRD | STRE | STRF | STRG | STRH

\*RST:                    STRA



**Example:**

```

SCONfiguration:OUTPut:MODE DIGM
SCONfiguration:APPLY
SOURce1:BB:GRAPhics:MODE PSP
SOURce1:BB:GRAPhics:FFTLen LEN2048
SOURce1:BB:GRAPhics:SOURce DO1
SOURce1:BB:GRAPhics:SOURce:MUX STRA
SOURce1:BB:GRAPhics:TRIGger:SOURce SOFT
SOURce1:BB:GRAPhics:SRATe:MODE AUTO
SOURce1:BB:GRAPhics:ADD MIN

```

**Manual operation:** See "[Mux Stream](#)" on page 632

### **[:SOURce]:BB:GRAPhics:FFTLen <Mode>**

Sets the FFT size.

**Parameters:**

<Mode>                   LEN256 | LEN512 | LEN1024 | LEN2048 | LEN4096 | LEN8192  
 \*RST:                    LEN2048

**Example:**               SOURce:BB:GRAPhics:FFTLen LEN2048

**Manual operation:** See "[FFT Length](#)" on page 632

### **[:SOURce]:BB:GRAPhics:FFTFscale <State>**

Defines the normalization of the power values in the power spectrum diagram.

**Parameters:**

<State>                   1 | ON | 0 | OFF  
**1**  
 Normalized power in dBFS  
**0**  
 Shows power distribution in dB/Hz  
 \*RST:                    0

**Example:**

```

SOURce:BB:GRAPhics:FFTFscale PSpectrum
SOURce:BB:GRAPhics:FFTFscale 1
// the power spectrum shows the normalized power in dBFS

```

**Manual operation:** See "[Full Scale \(dBFS\)](#)" on page 632

### **[:SOURce<hw>]:BB:GRAPhics:TRIGger:SOURce <Source>**

Defines the trigger for the starting time of the graphic recording.

**Parameters:**

<Source>                   | SOFTware | MARKer  
 \*RST:                    SOFTware

**Example:**               SOURce1:BB:GRAPhics:TRIGger:SOURce MARKer  
 Sets the trigger source.

**Manual operation:** See ["Trigger Source"](#) on page 632

#### 14.19.5.7 SOURce:BB:MEASurement subsystem

This subsystem contains the commands for measuring the power values of the digital baseband signal.

##### Required options

See [Section 9.2.1, "Required options"](#), on page 645

##### Example: Querying information on burst baseband signals using the multi-gated acquisition

The following example lists the commands necessary to start baseband power measurements and retrieve measurements results. We assume, that the instrument is configured as described in ["To measure the baseband power via multi-gated acquisition"](#) on page 659.

```
// configure and enable baseband power measurements
:SOURce:BB:MEASurement:POWer:SOURce BBA
:SOURce:BB:MEASurement:POWer:OUTPut RFA
:SOURce:BB:MEASurement:POWer:ACQuisition MGATed
:SOURce:BB:MEASurement:POWer:GSource MGATed
:SOURce:BB:MEASurement:POWer:DURation 0.1
:SOURce:BB:MEASurement:POWer:RMODe SINGLE
:SOURce:BB:MEASurement:POWer:ADD
:SOURce:BB:MEASurement:POWer:EXECute

// query status information on the initiated measurement
:SOURce:BB:MEASurement:POWer:PROGress?
// Response: 23
// the initiated measurement is in progress
:SOURce:BB:MEASurement:POWer:RState?
// Response: 1
:SOURce:BB:MEASurement:POWer:PROGress?
// Response: 100
:SOURce:BB:MEASurement:POWer:RState?
// Response: 0
// performed is one single measurement

// query baseband power values
:SOURce:BB:MEASurement:POWer:PEAK?
// Response: -24.0601192007,-24.0601192007,-24.0601192007,-24.0601192007
:SOURce:BB:MEASurement:POWer:RMS?
// Response: -35.0006514336062,-35.0006514336062,-35.0006514336062,-35.0006514336062
// performed are four sub-measurements

// stop and remove the measurement
```

```
:SOURce:BB:MEASurement:POWer:INDeX 1
:SOURce:BB:MEASurement:POWer:ABORt
:SOURce:BB:MEASurement:POWer:DELeTe
```

<a href="#">[:SOURce]:BB:MEASurement:POWer:SOURce</a> .....	1179
<a href="#">[:SOURce]:BB:MEASurement:POWer:OUTPut</a> .....	1179
<a href="#">[:SOURce]:BB:MEASurement:POWer:ACQuisition</a> .....	1180
<a href="#">[:SOURce]:BB:MEASurement:POWer:GSOURce</a> .....	1180
<a href="#">[:SOURce]:BB:MEASurement:POWer:RMODE</a> .....	1180
<a href="#">[:SOURce]:BB:MEASurement:POWer:ADD</a> .....	1180
<a href="#">[:SOURce]:BB:MEASurement:POWer:PEAK?</a> .....	1181
<a href="#">[:SOURce]:BB:MEASurement:POWer:RMS?</a> .....	1181
<a href="#">[:SOURce]:BB:MEASurement:POWer:RSState?</a> .....	1181
<a href="#">[:SOURce]:BB:MEASurement:POWer:PROGress?</a> .....	1182
<a href="#">[:SOURce]:BB:MEASurement:POWer:DUration</a> .....	1182
<a href="#">[:SOURce]:BB:MEASurement:POWer:INDeX</a> .....	1182
<a href="#">[:SOURce]:BB:MEASurement:POWer:CHANGe</a> .....	1183
<a href="#">[:SOURce]:BB:MEASurement:POWer:EXECute</a> .....	1183
<a href="#">[:SOURce]:BB:MEASurement:POWer:ABORt</a> .....	1183
<a href="#">[:SOURce]:BB:MEASurement:POWer:DELeTe</a> .....	1183

---

#### **[:SOURce]:BB:MEASurement:POWer:SOURce <Source>**

Defines the measurement signal source.

##### **Parameters:**

<Source>            BBA | BBB | BBC | BBD | BBINA | BBINB | FADINPA |  
 FADINPB | FADINPC | FADINPD | FADOUTA | FADOUTB |  
 FADOUTC | FADOUTD | AWGNA | AWGNB | AWGNC |  
 AWGND | STREAMA | STREAMB | STREAMC | STREAMD  
 \*RST:            BBA

**Example:**            See [Example "Querying information on burst baseband signals using the multi-gated acquisition"](#) on page 1178

**Manual operation:**    See ["Source"](#) on page 651  
 See ["Output"](#) on page 651

---

#### **[:SOURce]:BB:MEASurement:POWer:OUTPut <Output>**

Defines the output point the measurement are performed at.

##### **Parameters:**

<Output>            RFA | RFB | IQOUT1 | IQOUT2 | BBMM1 | BBMM2  
 \*RST:            RFA

**Example:**            See [Example "Querying information on burst baseband signals using the multi-gated acquisition"](#) on page 1178

**Manual operation:**    See ["Output"](#) on page 651

---

**[[:SOURce]:BB:MEASurement:POWer:ACQuisition <Acquisition>**

Sets the acquisition method.

**Parameters:**

<Acquisition>      NOMinal | CONTInuous | GATed | MGATed  
\*RST:              CONTInuous

**Example:**              See [Example "Querying information on burst baseband signals using the multi-gated acquisition"](#) on page 1178

**Manual operation:**    See ["Acquisition"](#) on page 651

---

**[[:SOURce]:BB:MEASurement:POWer:GSource <GateSource>**

Determines the marker signal defining the signal part to be evaluated. The available values depend on the selected acquisition ([\[:SOURce\]:BB:MEASurement:POWer:ACQuisition](#)).

**Parameters:**

<GateSource>        NONE | MARK1 | MARK2 | MARK3 | MGATed  
**NONE**  
Default value for nominal and continuous acquisition.  
**MARK1|MARK2|MARK3**  
Marker signal as defined in the baseband  
**MGATed**  
Reserved for multi gated acquisition  
\*RST:              NONE

**Example:**              See [Example "Querying information on burst baseband signals using the multi-gated acquisition"](#) on page 1178

**Manual operation:**    See ["Gate Source"](#) on page 652

---

**[[:SOURce]:BB:MEASurement:POWer:RMODE <RunMode>**

Determines whether a single or a continuous measurement is executed.

**Parameters:**

<RunMode>            SINGLE | AUTO  
\*RST:              AUTO

**Example:**              See [Example "Querying information on burst baseband signals using the multi-gated acquisition"](#) on page 1178

**Manual operation:**    See ["Run Mode"](#) on page 653

---

**[[:SOURce]:BB:MEASurement:POWer:ADD**

Adds a measurement.

- Example:** See [Example "Querying information on burst baseband signals using the multi-gated acquisition"](#) on page 1178
- Usage:** Event
- Manual operation:** See ["Add/Change/Remove/Start/Abort"](#) on page 653

**[ :SOURce ] :BB :MEASurement :POWER :PEAK ?**

Queries the peak power of the baseband signal at the measurement point determined with the command `[ :SOURce ] :BB :MEASurement :POWER :OUTPut`.

**Return values:**

<PeakPower> <Peak\_SubMes#1>,<Peak\_SubMes#2>,...

Returns the peak power of the measured signal or if a multi-gated acquisition is used, a string of measured values with one value per performed submeasurement

Range: -145 to 30

- Example:** See [Example "Querying information on burst baseband signals using the multi-gated acquisition"](#) on page 1178
- Usage:** Query only
- Manual operation:** See ["PEP/Level"](#) on page 652

**[ :SOURce ] :BB :MEASurement :POWER :RMS ?**

Queries the RMS power of the baseband signal at the measurement point determined with the command `[ :SOURce ] :BB :MEASurement :POWER :OUTPut`.

**Return values:**

<RmsPower> <Power\_SubMes#1>,<Level\_SubMes#2>,...

Returns the power of the measured signal or if a multi-gated acquisition is used, a string of measured values with one value per performed submeasurement

Range: -145 to 30

- Example:** See [Example "Querying information on burst baseband signals using the multi-gated acquisition"](#) on page 1178
- Usage:** Query only
- Manual operation:** See ["PEP/Level"](#) on page 652

**[ :SOURce ] :BB :MEASurement :POWER :RState ?**

Queries the state (running/stopped) of the current measurement.

**Return values:**

<RunState> 1 | ON | 0 | OFF

\*RST: 0

- Example:** See [Example "Querying information on burst baseband signals using the multi-gated acquisition"](#) on page 1178
- Usage:** Query only
- Manual operation:** See ["Running/Stopped"](#) on page 653

#### **[[:SOURce]:BB:MEASurement:POWER:PROGress?**

Queries the status of the initiated measurement. The query returns a value that indicates the task progress in percent.

**Return values:**

<Progress> float  
 Range: 0 to 100  
 \*RST: 0

- Example:** See [Example "Querying information on burst baseband signals using the multi-gated acquisition"](#) on page 1178
- Usage:** Query only
- Manual operation:** See ["Baseband powers table"](#) on page 651

#### **[[:SOURce]:BB:MEASurement:POWER:DURation <Duration>**

Sets the measurement's time of a single measurement.

**Parameters:**

<Duration> float  
 Range: 1E-3 to 5400  
 Increment: 1E-3  
 \*RST: 1

- Example:** see [Example "Querying information on burst baseband signals using the multi-gated acquisition"](#) on page 1178
- Manual operation:** See ["Sweep Time/Duration"](#) on page 652

#### **[[:SOURce]:BB:MEASurement:POWER:INDEX <MeasIndex>**

Selects the measurement index the subsequent settings apply to, for example changing, starting or removing from the list of measurements.

**Parameters:**

<MeasIndex> integer  
 Range: 1 to dynamic  
 \*RST: 1

- Example:** see [Example "Querying information on burst baseband signals using the multi-gated acquisition"](#) on page 1178
- Manual operation:** See ["Add/Change/Remove/Start/Abort"](#) on page 653

---

**[[:SOURce]:BB:MEASurement:POWer:CHANge**

Triggers the instrument to adopt the changed measurement configuration.

**Example:** See [Example "Querying information on burst baseband signals using the multi-gated acquisition"](#) on page 1178

**Usage:** Event

**Manual operation:** See ["Add/Change/Remove/Start/Abort"](#) on page 653

---

**[[:SOURce]:BB:MEASurement:POWer:EXECute**

Triggers the instrument to perform the configured measurement.

**Example:** See [Example "Querying information on burst baseband signals using the multi-gated acquisition"](#) on page 1178

**Usage:** Event

**Manual operation:** See ["Add/Change/Remove/Start/Abort"](#) on page 653

---

**[[:SOURce]:BB:MEASurement:POWer:ABORT**

Stops the current measurement.

**Example:** See [Example "Querying information on burst baseband signals using the multi-gated acquisition"](#) on page 1178

**Usage:** Event

**Manual operation:** See ["Add/Change/Remove/Start/Abort"](#) on page 653

---

**[[:SOURce]:BB:MEASurement:POWer:DELeTe**

Removes the selected measurement from the list.

**Example:** See [Example "Querying information on burst baseband signals using the multi-gated acquisition"](#) on page 1178

**Usage:** Event

**Manual operation:** See ["Add/Change/Remove/Start/Abort"](#) on page 653

---

#### 14.19.5.8 SOURce:BB:PROGress subsystem

In the R&S SMW200A, some calculation processes take longer time. While operating the instrument manually, you can observe the status of an initiated process by the busy indicator. The following commands fulfill the same task in the remote control operation.

**Example: Querying the status of the "Create Waveform"**

The following example provides information on the status during the "Create Waveform" file processing. You can query progress information of this process.

```
:SCONfiguration:MODE ADVanced
:SCONfiguration:FADing MIMO4x4
:SCONfiguration:BASEband:SOURce COUPled
:SCONfiguration:APPLY
:SOURce1:BB:PROGress:MCODer:DM:FILTer?
// 100 (task completed)
```

```
:SOURce1:BB:EUTRa:SETting:TMOD:DL "E-TM1_1__15MHz"
:SOURce1:BB:EUTRa:SLENgth 100
:SOURce1:BB:PROGress:MCODer?
// 100 (task completed)
:SOURce1:BB:EUTRa:STATe ON
:BB:PROGress:MCODer?
// 67 (task in progress)
:SOURce1:BB:EUTRa:WAVEform:CREate
:SOURce1:BB:PROGress:MCODer?
// 25 (task in progress)
```

```
[[:SOURce<hw>]:BB:PROGress:MCODer?..... 1184
[:SOURce<hw>]:BB:PROGress:MCODer:ARBitrary:MCARrier?..... 1184
[:SOURce<hw>]:BB:PROGress:MCODer:ARBitrary:WSEGment?..... 1184
[:SOURce<hw>]:BB:PROGress:MCODer:DM:FILTer?..... 1184
```

---

#### **[[:SOURce<hw>]:BB:PROGress:MCODer?**

#### **[[:SOURce<hw>]:BB:PROGress:MCODer:ARBitrary:MCARrier?**

#### **[[:SOURce<hw>]:BB:PROGress:MCODer:ARBitrary:WSEGment?**

Queries the status of an initiated process. This process can be, for example, the calculation of a signal in accordance to a digital standard, or the calculation of a multicarrier or multi-segment waveform file.

#### **Return values:**

<WSegment>            integer  
                          Indicates the task progress in percent  
                          Range:     0 to 100  
                          \*RST:     100

**Example:**            See [Example "Querying the status of the "Create Waveform"](#) on page 1183.

**Usage:**                Query only

---

#### **[[:SOURce<hw>]:BB:PROGress:MCODer:DM:FILTer?**

Queries the status of an applied offline filtering, like for example during the calculation of a waveform and a multi carrier waveform file.



**Return values:**

<Filter> integer  
 Indicates the task progress in percent  
 Range: 0 to 100  
 \*RST: 100

**Example:** see [Example "Querying the status of the "Create Waveform"](#) on page 1183

**Usage:** Query only

## 14.19.6 SOURce:CORRection subsystem

The SOURce:CORRection subsystem contains the commands for defining correction values for external test assemblies.

You can acquire the correction values anytime, regardless of the modulation settings of the generator. During correction, the R&S SMW200A adds the correction values to the output level of the respective RF frequency.

Determine the correction values in one of the following ways:

- Measure the RF output level at several frequency points and enter the value pairs manually in a table
- Connect an R&S NRP to the generator output signal and send the command [ : SOURce<hw> ] : CORRection : CSET : DATA [ : SENSor<ch> ] [ : POWer ] : SONCe to fill the table automatically.

Save correction values to files with file extension \* . uco.

Refer to [Section 14.7.2, "Handling files in the default or in a specified directory"](#), on page 906 for general information on file handling in the default and in a specific directory.

### User-defined frequency response corrections

Using user-defined frequency response correction requires option R&S SMW-K544.

See the user manual "R&S SMW-K544 User-Defined Frequency Response Correction".

### Programming examples

The examples in this section assume that:

- The files are stored in the default directory.
- The same tables are accessed for both paths. File operations such as creating, deleting and querying files are therefore path-independent.  
 In this case, omit the suffix in the keyword SOURce. An error message is displayed if the suffix is specified.
- \*RST does not affect data lists.

**Example: To create RF level correction values**

The following example shows a command sequence to create and activate a list for assigning level correction values to arbitrary RF frequencies. Further hardware settings are not considered.

```
// Reset the instrument to start from an initial state
// Query the available user correction list files in the default
// directory. Select a file or create a file.
// *****
*RST; *CLS
:SOURce1:CORRection:CSET:CATalog?
// Response: "ucor1"
// Select the file ucor1.uco.
:SOURce1:CORRection:CSET:SElect "/var/user/ucor1"

// Enter the frequency/level value pairs in the table; existing data
// is overwritten. Query the number of frequency/power entries.
:SOURce1:CORRection:CSET:DATA:FREQuency 100MHz,110MHz,120MHz,130MHz,140MHz,150MHz
:SOURce1:CORRection:CSET:DATA:POWer -10,-7.5,-5.0,-2.5,0,2.5
:SOURce1:CORRection:CSET:DATA:FREQuency:POINTs?
// 6
:SOURce1:CORRection:CSET:DATA:POWer:POINTs?
// 6

// Enable user correction mode and RF output
:SOURce1:CORRection:STATe 1
:OUTPut1:STATe ON

// Query the currently used correction value
:SOURce1:CORRection:VALue?
// -2.5

// Delete a user correction file
:SOURce1:CORRection:CSET:DELEte "/var/user/ucor1.uco"
```

**Example: To fill user correction data with a sensor**

The following example shows a command sequence to fill a user correction list automatically supported by a connected R&S NRP.

```
// Fill a user correction list with the level values
// measured by an R&S NRP,
// store the data in a file and enable user correction.

*RST; *CLS

:SOURce1:CORRection:CSET:SElect "/var/user/Ucor1_AutoFill.uco"
:SOURce1:CORRection:CSET:DATA:FREQuency 100MHz,110MHz,120MHz,130MHz,140MHz,150MHz
:SOURce1:CORRection:ZERoing:STATe 1
:SOURce1:CORRection:CSET:DATA:SENSor1:POWer:SONCe
```

```
// Query the number of automatically filled correction level values
:SOURce1:CORRection:CSEt:DATA:POWer:POINtS?
// 6
:SOURce1:CORRection:STATe 1

// Query the correction value at a certain frequency
:FREQ 120000000
:SOURce1:CORRection:VALue?
// -52.13
```

### Example: To export user correction lists

The following example shows a command sequence to export a user correction list (here the list created with the example before) into an ASCII file. Further hardware settings are not considered.

```
// Select a user correction file for exporting to file in ASCII format
// Set ASCII data parameters
// Set the ASCII file extension, the decimal separator
// and the column separator for the ASCII data
:SOURce1:CORRection:DEXChange:AFILe:CATALog?
// my_ucor
:SOURce1:CORRection:CSEt:CATALog?
// ucor1,Ucor1_AutoFill
:SOURce1:CORRection:CSEt:SElect "/var/user/Ucor1_AutoFill.uco"
:SOURce1:CORRection:DEXChange:AFILe:EXTension CSV
:SOURce1:CORRection:DEXChange:AFILe:SEParator:DECimal DOT
:SOURce1:CORRection:DEXChange:AFILe:SEParator:COLumn COMMa

// Select source and destination
:SOURce1:CORRection:DEXChange:AFILe:SElect "/var/user/ucor2ASCII"

// Export the user correction data into the ASCII file
:SOURce1:CORRection:DEXChange:MODE EXPort
:SOURce1:CORRection:DEXChange:EXECute

// Query the available ASCII files with extension .csv
:SOURce1:CORRection:DEXChange:AFILe:CATALog?
// ucor2ASCII,my_ucor

// Import a user correction ASCII file
:SOURce1:CORRection:DEXChange:MODE IMPort
:SOURce1:CORRection:DEXChange:AFILe:SElect "/var/user/my_ucor"
:SOURce1:CORRection:DEXChange:EXECute
```

### Commands:

- [Correction settings](#)..... 1188
- [Correction data exchange](#)..... 1191
- [SOURce:CORRection:OPTimize subsystem](#)..... 1193

### 14.19.6.1 Correction settings

---

**[ :SOURce<hw>]:CORRection:CSET:DATA:FREQuency <Frequency>**

Enters the frequency value in the table selected with **[ :SOURce<hw>]:CORRection:CSET[:SELEct]**.

**Parameters:**

<Frequency>                    Frequency#1[, Frequency#2, ...]  
String of values with default unit Hz.

**Example:**                    See [Example "To create RF level correction values"](#) on page 1186 .

**Manual operation:**    See ["Frequency \(Hz\)"](#) on page 594

---

**[ :SOURce<hw>]:CORRection:CSET:DATA:POWEr <Power>**

Enters the level values to the table selected with **[ :SOURce<hw>]:CORRection:CSET[:SELEct]**.

**Parameters:**

<Power>                        Power#1[, Power#2, ...]  
String of values with default unit dB.  
\*RST: 0

**Example:**                    See [Example "To create RF level correction values"](#) on page 1186 .

**Manual operation:**    See ["Correction Value \(dB\)"](#) on page 595

---

**[ :SOURce<hw>]:CORRection:CSET:DATA:FREQuency:POINts?**  
**[ :SOURce<hw>]:CORRection:CSET:DATA:POWEr:POINts?**

Queries the number of frequency/level values in the selected table.

**Return values:**

<Points>                        integer  
Range:                        0 to 10000  
\*RST:                         0

**Example:**                    See [Example "To create RF level correction values"](#) on page 1186 .

**Usage:**                        Query only

---

**[ :SOURce<hw>]:CORRection:CSET:DATA[:SENSor<ch>][:POWEr]:SONCe**

Fills the selected user correction table with the level values measured by the power sensor for the given frequencies.

To select the used power sensor set the suffix in key word `SENSe`.

**Example:** See [Example "To fill user correction data with a sensor"](#) on page 1186.

**Usage:** Event

**Manual operation:** See ["Fill User Correction Data with Sensor"](#) on page 597

**[:SOURce<hw>]:CORRection:CSET[:SELEct] <Filename>**

Selects or creates a file for the user correction data.

If the file with the selected name does not exist, a new file is created.

**Parameters:**

<Filename> string  
 Filename or complete file path; file extension can be omitted.

**Example:** See [Example "To create RF level correction values"](#) on page 1186 .

**Manual operation:** See ["UCOR Data"](#) on page 593

**[:SOURce<hw>]:CORRection:VALue?**

Queries the current value for user correction.

**Return values:**

<Value> float  
 Range: -100 to 100  
 Increment: 0.01  
 \*RST: 0

**Example:** See [Example "To create RF level correction values"](#) on page 1186 .

**Usage:** Query only

**Manual operation:** See ["User Correction"](#) on page 593

**[:SOURce<hw>]:CORRection:ZERoing:STATe <State>**

Activates the zeroing procedure before filling the user correction data acquired by a sensor.

**Parameters:**

<State> 1 | ON | 0 | OFF  
 \*RST: 1

**Example:** See [Example "To fill user correction data with a sensor"](#) on page 1186.

**Manual operation:** See ["Fill User Correction Data with Sensor"](#) on page 597

---

**[:SOURce<hw>]:CORRection:CSET:DATA[:SENSor<ch>][:POWer]:SONCe**

Fills the selected user correction list with the level values measured by the power sensor for the given frequencies.

**Suffix:**

SENSor<ch> Defines the used power sensor, i.e. the sensor whose values are used.

**Example:** See [Example "To fill user correction data with a sensor"](#) on page 1186.

**Usage:** Event

---

**[:SOURce<hw>]:CORRection[:STATe] <State>**

Activates user correction with the currently selected table.

**Parameters:**

<State> 1 | ON | 0 | OFF  
\*RST: 0

**Example:** See [Example "To create RF level correction values"](#) on page 1186 .

**Manual operation:** See ["State"](#) on page 592

---

**[:SOURce]:CORRection:CSET:CATalog?**

Queries a list of available user correction tables.

**Return values:**

<Catalog> string  
List of list filenames, separated by commas

**Example:** See [Example "To create RF level correction values"](#) on page 1186 .

**Usage:** Query only

**Manual operation:** See ["UCOR Data"](#) on page 593  
See ["Directory, File List and Filename"](#) on page 710

---

**[:SOURce]:CORRection:CSET:DELeTe <Filename>**

Deletes the specified user correction list file.

**Setting parameters:**

<Filename> string  
Filename or complete file path; file extension is optional.

**Example:** See [Example "To create RF level correction values"](#) on page 1186 .

**Usage:** Setting only  
**Manual operation:** See ["UCOR Data"](#) on page 593

#### 14.19.6.2 Correction data exchange

With the following commands, you can configure user correction lists and export or import them accordingly.

---

##### **[:SOURce<hw>]:CORRection:DEXChange:AFILe:CATalog?**

Queries the available ASCII files for export or import of user correction data in the current or specified directory.

**Return values:**

<Catalog> string  
 List of ASCII files \*.txt or \*.csv, separated by commas.

**Example:** See [Example "To create RF level correction values"](#) on page 1186 .

**Usage:** Query only

**Manual operation:** See ["Select \(ASCII\) Source/Select \(ASCII\) Destination"](#) on page 541

---

##### **[:SOURce<hw>]:CORRection:DEXChange:AFILe:EXTension <Extension>**

Determines the extension of the ASCII files for file import or export, or to query existing files.

**Parameters:**

<Extension> TXT | CSV  
 \*RST: TXT

**Example:** See [Example "To export user correction lists"](#) on page 1187 .

**Manual operation:** See ["ASCII File Settings"](#) on page 541

---

##### **[:SOURce<hw>]:CORRection:DEXChange:AFILe:SElect <Filename>**

Selects the ASCII file to be imported or exported.

**Parameters:**

<Filename> string  
 Filename or complete file path; file extension can be omitted.

**Example:** See [Example "To export user correction lists"](#) on page 1187 .

**Manual operation:** See ["Select \(ASCII\) Source/Select \(ASCII\) Destination"](#) on page 541

---

**[ :SOURce<hw>]:CORRection:DEXChange:AFILe:SEParator:COLumn <Column>**

Selects the separator between the frequency and level column of the ASCII table.

**Parameters:**

<Column>            TABulator | SEMicolon | COMMa | SPACe  
 \*RST:            COMMa

**Example:**            See [Example "To export user correction lists"](#) on page 1187 .

**Manual operation:**    See ["ASCII File Settings"](#) on page 541

---

**[ :SOURce<hw>]:CORRection:DEXChange:AFILe:SEParator:DECimal <Decimal>**

Sets the decimal separator used in the ASCII data between '.' (decimal point) and ',' (comma) with floating-point numerals.

**Parameters:**

<Decimal>            DOT | COMMa  
 \*RST:            DOT

**Example:**            See [Example "To export user correction lists"](#) on page 1187 .

**Manual operation:**    See ["ASCII File Settings"](#) on page 541

---

**[ :SOURce<hw>]:CORRection:DEXChange:EXECute**

Executes the import or export of the selected correction list, according to the previously set transfer direction with command `[ :SOURce<hw>]:CORRection:DEXChange:MODE`.

**Example:**            See [Example "To export user correction lists"](#) on page 1187 .

**Usage:**            Event

**Manual operation:**    See ["Import / Export"](#) on page 541

---

**[ :SOURce<hw>]:CORRection:DEXChange:MODE <Mode>**

Determines import or export of a user correction list.

Specify the source or destination file with the command `[ :SOURce<hw>]:CORRection:DEXChange:SELection`.

**Parameters:**

<Mode>            IMPort | EXPort  
 \*RST:            IMPort

**Example:**            See [Example "To export user correction lists"](#) on page 1187 .

**Manual operation:**    See ["Mode"](#) on page 540



---

**[:SOURce<hw>]:CORRection:DEXChange:SElect <Filename>**

Selects the ASCII file for import or export, containing a user correction list.

**Parameters:**

<Filename>                    string  
                                   Filename or complete file path; file extension can be omitted.

**Example:**                    See [Example "To export user correction lists"](#) on page 1187 .

**Manual operation:**    See ["Select Source/Select ASCII Destination"](#) on page 541

### 14.19.6.3 SOURce:CORRection:OPTimize subsystem

The SOURce:CORRection:OPTimize subsystem contains the commands for defining correction values for predefined digital predistortion to linearize the RF signal.

You can acquire the correction values anytime, regardless of the modulation settings of the generator. During correction, the R&S SMW200A adds the correction values to the output level of the respective RF frequency.

**Example: Optimizing I/Q modulation for best EVM performance**

```
// Select EVM optimization as the I/Q modulation method.
:SOURce1:CORRection:OPTimize:RF:CHARacteristics EVM

// Query the state of the I/Q modulator adjustments.
:SOURce1:CORRection:OPTimize:RF:IQModulator?
// Response: "1"
// Enabled are automatic I/Q modulator adjustments after each RF signal
// settings change.
:SOURce1:CORRection:OPTimize:RF:HEADroom?
// Response: "1"
// Enabled are automatic digital headroom adjustments after each RF signal
// settings change.
:SOURce1:CORRection:OPTimize:RF:LINEarize?
// Response: "AUTO"
// Automatic RF linearizations requires option R&S SMW-K575.
// Response: "OFF"
// No RF linearizations enabled, that is the default mode without option R&S SMW-K575.
```

**Example: Applying user-defined I/Q modulation optimizations**

```
// Select user-defined optimization as the I/Q modulation method.
:SOURce1:CORRection:OPTimize:RF:CHARacteristics USER

// Query the state of the I/Q modulator adjustments.
:SOURce1:CORRection:OPTimize:RF:IQModulator?
// Response: "0"
// Disabled are automatic I/Q modulator adjustments after each RF signal
// settings change. To apply automatic I/Q modulator adjustments apply a manual
// adjustment first.
```

```

:SOURce1:CORRection:OPTimize:RF:IQModulator:ADJUsT
:SOURce1:CORRection:OPTimize:RF:IQModulator 1
// Enabled are automatic I/Q modulator adjustments after each RF signal
// settings change.

// Query other automatic adjustment states.
:SOURce1:CORRection:OPTimize:RF:HEADroom?
// Response: "0"
// Disabled are automatic digital headroom adjustments after each RF signal
// settings change.
:SOURce1:CORRection:OPTimize:RF:LINearize?
// Response: "OFF"
// No RF linearizations enabled.

```

### Example: Linearizing the RF signal automatically

#### Option: R&S SMW-K575

```

// Enable I/Q modulation of the baseband signal.
:SOURce1:IQ:SOURce BAS
:SOURce1:IQ:STATe 1

:SOURce1:CORRection:OPTimize:RF:LINearize AUTO
// Uses the AM/AM and AM/PM predistortion data from a factory calibration to
// to linearize the RF output signal at high output powers.

```

### Example: Linearizing the RF signal manually

```

// Enable I/Q modulation of the baseband signal.
:SOURce1:IQ:SOURce BAS
:SOURce1:IQ:STATe 1

:SOURce1:CORRection:OPTimize:RF:LINearize:ADJUsT
// Calculates AM/AM correction data for the current RF signal settings.
:SOURce1:CORRection:OPTimize:RF:LINearize MANUal
// Applies the correction data to adjuast level and frequency of the RF signal.
// If equipped with option R&S SMW-K575, uses also AM/PM
// correction data from factory calibration.

```

### Commands:

<a href="#">[:SOURce&lt;hw&gt;]:CORRection:OPTimize:RF:CHARacteristics</a> .....	1195
<a href="#">[:SOURce&lt;hw&gt;]:CORRection:OPTimize:RF:HEADroom</a> .....	1195
<a href="#">[:SOURce&lt;hw&gt;]:CORRection:OPTimize:RF:IQModulator</a> .....	1195
<a href="#">[:SOURce&lt;hw&gt;]:CORRection:OPTimize:RF:IQModulator:ADJUsT?</a> .....	1196
<a href="#">[:SOURce&lt;hw&gt;]:CORRection:OPTimize:RF:LINearize</a> .....	1196
<a href="#">[:SOURce&lt;hw&gt;]:CORRection:OPTimize:RF:LINearize:ADJUsT?</a> .....	1197

---

**[:SOURce<hw>]:CORRection:OPTimize:RF:CHARacteristics <Characteristic>**

Sets the method for optimizing the I/Q modulation.

**Parameters:**

<Characteristic> OFF | EVM | USER

**OFF**

No dedicated I/Q modulation optimization.

**EVM**

Optimizes I/Q modulation to achieve better EVM performance. This method reduces the wideband noise and improves the non-linear effects of amplifiers resulting in a linear gain.

**USER**

Sets a user-defined optimization as the I/Q modulation method.

\*RST: OFF

**Example:** See [Example "Optimizing I/Q modulation for best EVM performance"](#) on page 1193.

**Example:** See [Example "Applying user-defined I/Q modulation optimizations"](#) on page 1193.

**Manual operation:** See ["Optimization Characteristics"](#) on page 472

---

**[:SOURce<hw>]:CORRection:OPTimize:RF:HEADroom <State>**

Enables automatic adjustments of the I/Q modulator after each RF frequency change or RF level change.

**Parameters:**

<State> 1 | ON | 0 | OFF

\*RST: 0

**Example:** See [Example "Applying user-defined I/Q modulation optimizations"](#) on page 1193.

**Manual operation:** See ["Digital Headroom"](#) on page 473

---

**[:SOURce<hw>]:CORRection:OPTimize:RF:IQModulator <State>**

Enables adjustments of the I/Q modulator after each RF frequency change or RF level change.

**Parameters:**

<State> 1 | ON | 0 | OFF

**1|ON**

Adjusts the I/Q modulator during modulation after each RF frequency change or RF level change.

**0|OFF**

No adjustments of the I/Q modulator during modulation.

\*RST: 0

**Example:** See [Example "Applying user-defined I/Q modulation optimizations"](#) on page 1193.

**Manual operation:** See ["I/Q Modulator"](#) on page 472

#### **[ :SOURce<hw>]:CORRection:OPTimize:RF:IQModulator:ADJust?**

Enables automatic adjustments of the I/Q modulator after each RF frequency change or RF level change.

**Return values:**

<AdjustError> 1 | ON | 0 | OFF

\*RST: n.a. (no preset. default: 0)

**Example:** See [Example "Applying user-defined I/Q modulation optimizations"](#) on page 1193.

**Usage:** Query only

**Manual operation:** See ["Adjust I/Q Modulator for current settings"](#) on page 474

#### **[ :SOURce<hw>]:CORRection:OPTimize:RF:LINearize <Linearize>**

Requires R&S SMW-K541 or R&S SMW-K575.

Selects the mode to apply a predefined AM/AM digital predistortion (DPD) to the nonlinear RF chain to linearize the RF signal.

**Parameters:**

<Linearize> OFF | AUTO | MANual

**OFF**

Disables applying the DPD to the nonlinear RF chain.

**AUTO**

Requires R&S SMW-K575.

Applies an automatic AM/AM predistortion of the nonlinear RF chain. This mode requires correction data from "Linearize RF for current settings".

**MANual**

Requires R&S SMW-K541.

Applies an AM/AM predistortion of the nonlinear RF chain. This mode requires correction data from "Linearize RF for current settings".

To receive the correction data, use the following command before using the manual mode to linearize the RF signal.

[\[ :SOURce<hw>\]:CORRection:OPTimize:RF:LINearize:ADJust?](#) on page 1197

\*RST: OFF

**Example:** See [Example "Linearizing the RF signal automatically"](#) on page 1194.

**Example:** See [Example "Linearizing the RF signal manually"](#) on page 1194.

**Manual operation:** See ["Linearize RF"](#) on page 473

---

#### **[:SOURce<hw>]:CORRection:OPTimize:RF:LINEarize:ADJust?**

Measures the AM/AM nonlinearity on the RF chain for the current frequency. During the measurement, the instrument interrupts signal generation.

**Return values:**

<AdjustResult> 1 | ON | 0 | OFF

\*RST: n.a. (no preset. default: 0)

**Example:** See [Example "Linearizing the RF signal manually"](#) on page 1194.

**Usage:** Query only

**Manual operation:** See ["Linearize RF for current settings"](#) on page 474

## 14.19.7 SOURce:FREQuency subsystem

The SOURce:FREQuency subsystem contains the commands used to define the frequency settings for the RF sources and sweeps.

**Example: Frequency configuration**

```
SOURce1:FREQuency:MODE CW
SOURce1:FREQuency:CW 6000000000
SOURce1:FREQuency:OFFSet 2000000000
SOURce1:FREQuency:MULTiplier 1.5
SOURce1:FREQuency:CW?
// 11000000000

// SOURce1:FREQuency:STEP:MODE USER
// SOURce1:FREQuency:STEP:INCRement 1000000
// SOURce1:FREQuency:CW UP

SOURce1:PHASe 2
SOURce1:PHASe:REFerence
```

### Example: Set up of LO coupling and LO level adjustment with three Rohde & Schwarz signal generators

This example shows the command sequences for coupling the oscillator signal of three signal generators connected according to the setup on [Figure 14-8](#).

Connect the instruments in a daisy-chain regarding the LO signal:

- Connect the LO OUT of the first generator with LO IN of the second
- Connect the LO OUT of the second generator with LO IN of the third.

The frequency is assumed to be 5 GHz.

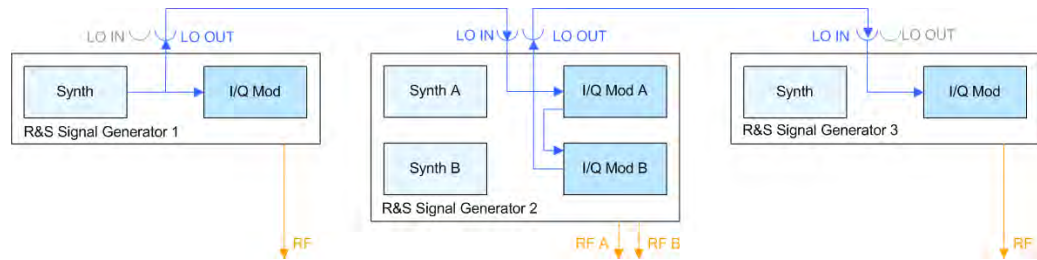

**Figure 14-8: Set up of LO coupling with three Rohde & Schwarz signal generators**

Signal generator#1 = One-path instrument, uses its internal oscillator signal.

Signal generator#2 = Two-paths instrument; receives the LO signal from the first instrument and assigns it to both paths

Signal generator#3 = One-path instrument; receives the LO signal from the second instrument

```
// *****
// Address and reset the first instrument
// *****
*RST; *CLS

// *****
// Configure the oscillator signal of the first instrument
// *****
SOURCE:FREQUENCY 5 GHz
SOURCE:FREQUENCY:LOSCillator:MODE INTERNAL
SOURCE:FREQUENCY:LOSCillator:OUTPut:STATE ON
SOURCE:FREQUENCY:LOSCillator:OUTPut:FREQUENCY?
// Response: 100000000

// *****
// Address and reset the second instrument, e.g. a R&S SMW
// *****
*RST; *CLS

// *****
// Configure the oscillator signal of the second instrument
// *****
SOURCE1:FREQUENCY 5 GHz
SOURCE1:FREQUENCY:LOSCillator:MODE ECoupled
SOURCE1:FREQUENCY:LOSCillator:OUTPut:STATE ON
```

```

// *****
// If the attenuation between the interconnection LO OUT and LO IN is
// greater than 1 dB at the oscillator frequency,
// we recommend that you perform the LO level adjustment
// *****
:CALibration:LOSCillator:COupling:LOCAL?

// *****
// Address and reset the third instrument
// *****
*RST; *CLS

// *****
// Configure the oscillator signal of the third next instrument
// *****
SOURce:FREQuency 5 GHz
SOURce:FREQuency:LOSCillator:MODE EXTernal
SOURce:FREQuency:LOSCillator:OUTPut:STATe OFF

// *****
// If the attenuation between the interconnection LO OUT and LO IN is
// greater than 1 dB at the oscillator frequency,
// we recommend that you perform the LO level adjustment
// *****
:CALibration:LOSCillator:COupling:LOCAL?

```

See also:

- ["To configure LO coupling with cascaded instruments"](#) on page 505
- ["To adjust the LO level to the current frequency"](#) on page 505

<a href="#">[:SOURce&lt;hw&gt;]:FREQuency:LOSCillator:INPut:FREQuency?</a> .....	1199
<a href="#">[:SOURce&lt;hw&gt;]:FREQuency:LOSCillator:MODE</a> .....	1200
<a href="#">[:SOURce&lt;hw&gt;]:FREQuency:LOSCillator:OUTPut:FREQuency?</a> .....	1201
<a href="#">[:SOURce&lt;hw&gt;]:FREQuency:LOSCillator:OUTPut:STATe</a> .....	1201
<a href="#">[:SOURce&lt;hw&gt;]:FREQuency:MODE</a> .....	1201
<a href="#">[:SOURce&lt;hw&gt;]:FREQuency[:CW FIXed]</a> .....	1202
<a href="#">[:SOURce&lt;hw&gt;]:FREQuency[:CW FIXed]:RCL</a> .....	1203
<a href="#">[:SOURce&lt;hw&gt;]:FREQuency:MANual</a> .....	1203
<a href="#">[:SOURce&lt;hw&gt;]:FREQuency:MULTiplier</a> .....	1203
<a href="#">[:SOURce&lt;hw&gt;]:FREQuency:OFFSet</a> .....	1204
<a href="#">[:SOURce&lt;hw&gt;]:FREQuency:CENTer</a> .....	1204
<a href="#">[:SOURce&lt;hw&gt;]:FREQuency:SPAN</a> .....	1205
<a href="#">[:SOURce&lt;hw&gt;]:FREQuency:STARt</a> .....	1205
<a href="#">[:SOURce&lt;hw&gt;]:FREQuency:STOP</a> .....	1205
<a href="#">[:SOURce&lt;hw&gt;]:FREQuency:STEP:MODE</a> .....	1206
<a href="#">[:SOURce&lt;hw&gt;]:FREQuency:STEP[:INCRement]</a> .....	1206

---

**[\[:SOURce<hw>\]:FREQuency:LOSCillator:INPut:FREQuency?](#)**

Queries the required external reference frequency.

**Return values:**

<Frequency> float  
 Range: 100E3 to 20E9  
 Increment: 0.01  
 \*RST: 0

**Example:** See [Example "Set up of LO coupling and LO level adjustment with three Rohde & Schwarz signal generators"](#) on page 1198.

**Usage:** Query only

**Manual operation:** See ["Mandatory LO IN Frequency"](#) on page 504

---

**[:SOURce<hw>]:FREQUENCY:LOSCillator:MODE <Mode>**

Selects the mode of the local oscillator coupling.

*Table 14-10: Cross-reference between <Mode> and the manual operation*

<Mode>	Parameter in manual operation	Description
INTernal	A&B Internal / Internal (one path instrument)	Uses the internal oscillator signal in both paths.
EXTernal	A External & B Internal (one path instrument)	Uses an external signal in path A. B uses its internal signal.
COUPlEd	A Internal & A->B Coupled	Assigns the internal oscillator signal of path A also to path B.
ECOUpLed	A External & A->B Coupled	Assigns an externally supplied signal to both paths.
BOFF	A Internal & B RF Off	Uses the internal local oscillator signal of path A, if the selected frequency exceeds the maximum frequency of path B.
EBOFF	A External & B RF Off	Uses the LO IN signal for path A, if the selected RF frequency exceeds the maximum frequency of path B.
AOFF	A RF Off & B External	Uses the LO IN signal for path B, if the selected RF frequency exceeds the maximum frequency of path A.

**Parameters:**

<Mode> INTernal | EXTernal | COUPlEd | ECOUpLed | BOFF | AOFF  
 See [Table 14-10](#)  
 \*RST: INTernal

**Example:** See [Example "Set up of LO coupling and LO level adjustment with three Rohde & Schwarz signal generators"](#) on page 1198.

**Manual operation:** See ["Mode"](#) on page 503



---

**[ :SOURce<hw> ] :FREQUENCY:LOSCillator:OUTPut:FREQUENCY?**

Queries the current frequency of the local oscillator at the [LO OUT] connector.

**Return values:**

<Frequency>	float
	Range: 100E3 to 20E9
	Increment: 0.01
	*RST: 0

**Example:** See [Example "Set up of LO coupling and LO level adjustment with three Rohde & Schwarz signal generators"](#) on page 1198.

**Usage:** Query only

**Manual operation:** See ["LO OUT Frequency"](#) on page 504

---

**[ :SOURce<hw> ] :FREQUENCY:LOSCillator:OUTPut:STATE <State>**

Activates the LO output in the second path.

**Parameters:**

<State>	1   ON   0   OFF
	*RST: 0

**Example:** See [Example "Set up of LO coupling and LO level adjustment with three Rohde & Schwarz signal generators"](#) on page 1198.

**Manual operation:** See ["Out State"](#) on page 504

---

**[ :SOURce<hw> ] :FREQUENCY:MODE <Mode>**

Sets the frequency mode for generating the RF output signal. The selected mode determines the parameters to be used for further frequency settings.

**Parameters:**

<Mode>	CW   FIXed   SWEep   LIST
--------	---------------------------

**CW|FIXed**

Sets the fixed frequency mode. CW and FIXed are synonyms.

The instrument operates at a defined frequency, set with command `[ :SOURce<hw> ] :FREQUENCY [ :CW | FIXed ]`.

**SWEep**

Sets sweep mode.

The instrument processes frequency (and level) settings in defined sweep steps.

Set the range and current frequency with the commands:

`[ :SOURce<hw> ] :FREQUENCY:START` on page 1205 and `[ :`

`SOURce<hw> ] :FREQUENCY:STOP` on page 1205,

`[ :SOURce<hw> ] :FREQUENCY:CENTer` on page 1204,

`[ :SOURce<hw> ] :FREQUENCY:SPAN` on page 1205,

`[ :SOURce<hw> ] :FREQUENCY:MANual` on page 1203

**LIST**

Sets list mode.

The instrument processes frequency and level settings by means of values loaded from a list.

To configure list mode settings, use the commands of the [Section 14.19.13, "SOURce:LIST subsystem"](#), on page 1240.

\*RST: CW

**Example:** See [Example "Frequency configuration"](#) on page 1197,

**Example:** See [Example "Setup an RF frequency or power sweep"](#) on page 1288

**Manual operation:** See ["State \(RF frequency sweep\)"](#) on page 527  
See ["State"](#) on page 536

**[ :SOURce<hw>]:FREQuency[:CW|FIXed] <Fixed>**

Sets the frequency of the RF output signal in the selected path.

The effect depends on the selected mode:

- In CW mode ([FREQ:MODE CW | FIXed](#)), the instrument operates at a fixed frequency.
- In sweep mode ([FREQ:MODE SWE](#)), the value applies to the sweep frequency. The instrument processes the frequency settings in defined sweep steps.
- In user mode ([FREQ:STEP:MODE USER](#)), you can vary the current frequency step by step.

**Parameters:**

<Fixed> float

The following settings influence the value range:

An offset set with the command [\[ :SOURce<hw> \] :FREQuency :OFFSet](#)

**Numerical value**

Sets the frequency in CW and sweep mode

**UP|DOWN**

Varies the frequency step by step in user mode.

The frequency is increased or decreased by the value set with the command [\[ :SOURce<hw> \] :FREQuency :STEP \[ :INCRement \]](#).

Range: (RFmin + OFFSet) to (RFmax + OFFSet)

\*RST: n.a.

**Example:** See [Example "Frequency configuration"](#) on page 1197

**Example:** See [Example "Setup an RF frequency or power sweep"](#) on page 1288

**Manual operation:** See ["Frequency"](#) on page 482

**[ :SOURce<hw>]:FREQUENCY[:CW|FIXed]:RCL <Rcl>**

Set whether the RF frequency value is retained or taken from a loaded instrument configuration, when you recall instrument settings with command `*RCL`.

The selected mode applies to both RF paths, i.e. a specified suffix is ignored.

**Parameters:**

<Rcl>	INCLude   EXCLude
	<b>INCLude</b>
	Takes the frequency value of the loaded settings.
	<b>EXCLude</b>
	Retains the current frequency when an instrument configuration is loaded.
<code>*RST:</code>	INCLude

**Example:** `SOURce1:FREQUENCY:CW:RCL INCLude`

**Manual operation:** See ["Exclude Frequency"](#) on page 712

**[ :SOURce<hw>]:FREQUENCY:MANual <Manual>**

Sets the frequency and triggers a sweep step manually if `SWEep:MODE MAN`.

**Parameters:**

<Manual>	float
	You can select any frequency within the setting range, where:
	<code>START</code> is set with <code>[ :SOURce&lt;hw&gt;]:FREQUENCY:START</code>
	<code>STOP</code> is set with <code>[ :SOURce&lt;hw&gt;]:FREQUENCY:STOP</code>
	<code>OFFSet</code> is set with <code>[ :SOURce&lt;hw&gt;]:FREQUENCY:OFFSet</code>
	Range: (START + OFFSet) to (STOP + OFFSet)
	Increment: 0.01Hz
<code>*RST:</code>	100 MHz
	Default unit: Hz

**Example:** See [Example "Setup an RF frequency or power sweep"](#) on page 1288

**Manual operation:** See ["Current Frequency"](#) on page 527

**[ :SOURce<hw>]:FREQUENCY:MULTIplier <Multiplier>**

Sets the multiplication factor  $N_{\text{FREQ:MULT}}$  of a subsequent downstream instrument.

The parameters offset  $f_{\text{FREQ:OFFSer}}$  and multiplier  $N_{\text{FREQ:MULT}}$  affect the frequency value set with the command `FREQ`.

The query `FREQ?` returns the value corresponding to the formula:

$$f_{\text{FREQ}} = f_{\text{RFout}} * N_{\text{FREQ:MULT}} + f_{\text{FREQ:OFFSer}}$$

See [Section 8.4.1.1, "Displayed RF frequency and level values with downstream instruments"](#), on page 480.

**Parameters:**

<Multiplier>	float
	Range: -10000 to 10000
	Increment: 0.001
	*RST: 1

**Example:** See [Example "Frequency configuration"](#) on page 1197

**Manual operation:** See ["Multiplier"](#) on page 483

**[:SOURce<hw>]:FREQuency:OFFSet <Offset>**

Sets the frequency offset  $f_{\text{FREQ:OFFSet}}$  of a downstream instrument.

The parameters offset  $f_{\text{FREQ:OFFSer}}$  and multiplier  $N_{\text{FREQ:MULT}}$  affect the frequency value set with the command [FREQ](#).

The query [FREQ?](#) returns the value corresponding to the formula:

$$f_{\text{FREQ}} = f_{\text{RFout}} * N_{\text{FREQ:MULT}} + f_{\text{FREQ:OFFSer}}$$

See [Section 8.4.1.1, "Displayed RF frequency and level values with downstream instruments"](#), on page 480.

**Note:** The offset also affects RF frequency sweep.

**Parameters:**

<Offset>	float
	Increment: 0.01
	*RST: 0

**Example:** See [Example "Frequency configuration"](#) on page 1197

**Manual operation:** See ["Offset"](#) on page 482

**[:SOURce<hw>]:FREQuency:CENTer <Center>**

Sets the center frequency of the sweep.

See [Section 8.10.2.1, "Correlating parameters in sweep mode"](#), on page 519.

**Parameters:**

<Center>	float
	Range: 300 kHz to RFmax
	Increment: 0.01 Hz
	*RST: 300E6
	Default unit: Hz

**Example:** See [Example "Setup an RF frequency or power sweep"](#) on page 1288

**Manual operation:** See ["Center Frequency"](#) on page 531

---

**[:SOURce<hw>]:FREQUENCY:SPAN <Span>**

Sets the span of the frequency sweep range.

See [Section 8.10.2.1, "Correlating parameters in sweep mode"](#), on page 519.

**Parameters:**

<Span>	float
	Full frequency range
	Increment: 0.01
	*RST: 400E6

**Example:** See [Example "Setup an RF frequency or power sweep"](#) on page 1288

**Manual operation:** See ["Span"](#) on page 531

---

**[:SOURce<hw>]:FREQUENCY:START <Start>**

Sets the start frequency for the RF sweep.

See [Section 8.10.2.1, "Correlating parameters in sweep mode"](#), on page 519.

**Parameters:**

<Start>	float
	Range: 300kHz to RFmax
	Increment: 0.01Hz
	*RST: 100 MHz

**Example:** See [Example "Setup an RF frequency or power sweep"](#) on page 1288

**Manual operation:** See ["Start Frequency/Stop Frequency"](#) on page 531

---

**[:SOURce<hw>]:FREQUENCY:STOP <Stop>**

Sets the stop frequency range for the RF sweep.

See [Section 8.10.2.1, "Correlating parameters in sweep mode"](#), on page 519.

**Parameters:**

<Stop>	float
	Range: 300kHz to RFmax
	Increment: 0.01Hz
	*RST: 500 MHz
	Default unit: Hz

**Example:** See [Example "Setup an RF frequency or power sweep"](#) on page 1288

**Manual operation:** See ["Start Frequency/Stop Frequency"](#) on page 531

---

**[[:SOURce<hw>]:FREQUENCY:STEP:MODE <Mode>**

Defines the type of step size to vary the RF frequency at discrete steps with the commands [FREQ UP](#) or [FREQ DOWN](#).

You can define the step mode for each path separately.

**Parameters:**

<Mode>	DECimal   USER
	<b>DECimal</b>
	Increases or decreases the level in steps of ten.
	<b>USER</b>
	Increases or decreases the level in increments, set with the command <a href="#">FREQ:STEP[:INCR]</a> .
*RST:	DECimal

**Example:** See [Example "Frequency configuration"](#) on page 1197.

**Manual operation:** See ["Variation Active"](#) on page 485

---

**[[:SOURce<hw>]:FREQUENCY:STEP[:INCRement] <Increment>**

Sets the step width.

You can use this value to vary the RF frequency with command [FREQ UP](#) or [FREQ DOWN](#).

If you have activated [FREQ:STEP:MODE USER](#).

**Note:** This value also applies to the step width of the rotary knob on the instrument and, in user-defined step mode, increases or decreases the frequency.

**Parameters:**

<Increment>	float
	Range: 0 Hz to RFmax - 100 kHz
	Increment: 0.01 Hz
*RST:	1E6

**Example:** See [Example "Frequency configuration"](#) on page 1197

**Manual operation:** See ["Variation Step"](#) on page 485

## 14.19.8 SOURce:FREQUENCY:CONVerter subsystem

The `SOURce:FREQUENCY:CONVerter` subsystem contains the commands used to define and query the frequency overrange parameters of the specific R&S SZU100A IQ Upconverter.

### Example: Querying the frequency overrange provided by an R&S SZU100A IQ Upconverter

```
// Query the information whether the connected R&S SZU
// provides an extended frequency range
// Enable the frequency overrange and query the frequency overrange limits
SOURcel:FREQuency:CONVerter:EXTErnal:OVERrange:ALLowed?
SOURcel:FREQuency:CONVerter:EXTErnal:OVERrange 1
SOURcel:FREQuency:CONVerter:EXTErnal:OVERrange:FREQuency:MIN?
SOURcel:FREQuency:CONVerter:EXTErnal:OVERrange:FREQuency:MAX?
```

```
[:SOURce<hw>]:FREQuency:CONVerter:EXTErnal:OVERrange:ALLowed[:STATe]?..... 1207
[:SOURce<hw>]:FREQuency:CONVerter:EXTErnal:OVERrange:FREQuency:MAX?..... 1207
[:SOURce<hw>]:FREQuency:CONVerter:EXTErnal:OVERrange:FREQuency:MIN?..... 1208
[:SOURce<hw>]:FREQuency:CONVerter:EXTErnal:OVERrange[:STATe]..... 1208
```

---

#### [:SOURce<hw>]:FREQuency:CONVerter:EXTErnal:OVERrange:ALLowed[:STATe]?

Queries if the connected external instrument provides the extended frequency range.

If confirmed, the R&S SMW200A indicates the corresponding parameters in the "RF Frequency" dialog, see ["Frequency Overrange"](#) on page 484.

#### Return values:

```
<OverrangAllowed> 1 | ON | 0 | OFF
*RST: 0
```

**Example:** See [Example "Querying the frequency overrange provided by an R&S SZU100A IQ Upconverter"](#) on page 1207

**Usage:** Query only

---

#### [:SOURce<hw>]:FREQuency:CONVerter:EXTErnal:OVERrange:FREQuency:MAX?

Indicates the minimum and maximum frequency range values of the connected external instrument.

The frequency overrange is based on the calibration data of the specific device.

#### Return values:

```
<OverrangFreqMax> float
Range: OverrangeMin to OverrangeMax
Increment: 0.01
*RST: OverrangeMax
```

**Usage:** Query only

**Manual operation:** See ["Maximal Frequency"](#) on page 484

**[[:SOURce<hw>]:FREQUENCY:CONVERTer:EXTernal:OVERrange:FREQUENCY:MIN?**

Indicates the minimum frequency value of the connected external instrument.

The frequency overrange is based on the calibration data of the specific device.

**Return values:**

<OverrangMinFreq> float  
 Range: OverrangeMin to OverrangeMax  
 Increment: 0.01  
 \*RST: OverrangeMin

**Example:** See [Example "Querying the frequency overrange provided by an R&S SZU100A IQ Upconverter"](#) on page 1207

**Usage:** Query only

**Manual operation:** See ["Minimal Frequency"](#) on page 484

**[[:SOURce<hw>]:FREQUENCY:CONVERTer:EXTernal:OVERrange[:STATE] <OverrangState>**

Enables the extended frequency range of a connected external instrument.

**Parameters:**

<OverrangState> 1 | ON | 0 | OFF  
 \*RST: 0

**Example:** See [Example "Querying the frequency overrange provided by an R&S SZU100A IQ Upconverter"](#) on page 1207

**Manual operation:** See ["Frequency Overrange Active"](#) on page 484

## 14.19.9 SOURce:INPut subsystem

The SOURce:INPut subsystem contains the commands for configuring the inputs for external modulation signals. The instrument trigger setting influences all sweeps and is effective in the List mode (Instrument Trigger).

[\[:SOURce<hw>\]:INPut:MODext:COUPling<ch>](#) ..... 1208  
[\[:SOURce<hw>\]:INPut:MODext:IMPedance<ch>](#) ..... 1209  
[\[:SOURce<hw>\]:INPut:TRIGger:SLOPe](#) ..... 1209

**[[:SOURce<hw>]:INPut:MODext:COUPling<ch> <Coupling>**

Selects the coupling mode for an externally applied modulation signal.

**Parameters:**

<Coupling> AC | DC  
**AC**  
 Passes the AC signal component of the modulation signal.



**DC**

Passes the modulation signal with both components, AC and DC.

\*RST: AC

**Example:**

INP:MOD:COUP AC

Selects the coupling mode AC for an externally applied modulation signal.

**Manual operation:** See "[Coupling \(AC/DC\)](#)" on page 574

**[SOURce<hw>]:INPut:MODext:IMPedance<ch> <Impedance>**

Sets the impedance (50 kOhm or High = 100 kOhm to ground) for the externally supplied modulation signal.

**Parameters:**

<Impedance> G50 | HIGH

\*RST: HIGH

**Example:**

INP:MOD:IMP 50

sets 50 kOhm to ground.

**Manual operation:** See "[Impedance](#)" on page 574

**[SOURce<hw>]:INPut:TRIGger:SLOPe <Slope>**

Sets the polarity of the active slope of an applied instrument trigger.

**Parameters:**

<Slope> NEGative | POSitive

\*RST: POSitive

**Manual operation:** See "[Trigger Slope](#)" on page 529

### 14.19.10 SOURce:IQ subsystem

The SOURce:IQ subsystem contains the commands for configuring the I/Q modulation.

**Required options**

See [Section 7.1, "Required options"](#), on page 458.

<a href="#">[:SOURce&lt;hw&gt;]:IQ:SOURce</a> .....	1210
<a href="#">[:SOURce&lt;hw&gt;]:IQ:STATE</a> .....	1210
<a href="#">[:SOURce&lt;hw&gt;]:IQ:GAIN</a> .....	1210
<a href="#">[:SOURce&lt;hw&gt;]:BB:IQGain</a> .....	1210
<a href="#">[:SOURce&lt;hw&gt;]:IQ:CREStfactor</a> .....	1211
<a href="#">[:SOURce&lt;hw&gt;]:IQ:SWAP[:STATE]</a> .....	1212
<a href="#">[:SOURce&lt;hw&gt;]:IQ:WBState</a> .....	1212

---

**[:SOURce<hw>]:IQ:SOURce <Source>**

Selects the input signal source for the I/Q modulator.

**Parameters:**

<Source>                    BASeband | | ANALog | DIFFerential

**BASeband**

Internal baseband signal

**ANALog**

External analog wideband I/Q signal

Enabling the I/Q modulator disables an enabled amplitude modulation of the RF output signal.

**DIFFerential**

External analog wideband I/Q signal

Enabling the I/Q modulator disables an enabled amplitude modulation of the RF output signal.

\*RST:            BASeband

**Example:**

SOURce1:IQ:SOURce BASeband

Sets the internal baseband signal as I/Q modulator source signal, for example an ARB signal.

**Options:**

DIFFerential requires R&S SMW-K739

**Manual operation:** See "[Source](#)" on page 468

---

**[:SOURce<hw>]:IQ:STATe <State>**

Enables the I/Q modulation.

**Parameters:**

<State>                    1 | ON | 0 | OFF

\*RST:            0

**Example:**

IQ:STAT ON

Enables the I/Q modulation.

**Manual operation:** See "[State](#)" on page 468

---

**[:SOURce<hw>]:IQ:GAIN <Gain>**

**[:SOURce<hw>]:BB:IQGain <IqGain>**

Sets the baseband gain for a wide dynamic range.

You can amplify the baseband signal power level (positive gain) or attenuate this level (negative gain) to optimize the I/Q modulation performance. The optimization is a trade-off between signal distortion and signal-to-noise ratio (SNR).

**Parameters:**

<IqGain>                    DBM4 | DBM2 | DB0 | DB2 | DB4 | DB8 | DB6 | DBM3 | DB3 |  
AUTO

Dynamic range of 16 dB divided into 2 dB steps.

**DBM2|DBM4**

"-4 dB"/"-2 dB"

Attenuates the baseband signal internally to minimize signal distortions and optimize the intermodulation characteristics of the modulated signal. But the SNR decreases, the signal noise increases.

**DB0**

0 dB

No changes on the baseband signal, applies no optimization.

**DB2|DB4|DB6|DB8**

"2 dB"/"4 dB"/"6 dB"/"8 dB"

Amplifies the baseband signal internally to maximize the SNR while minimizing the signal noise is minimized. But the signal distortions increase.

**DBM3|DB3**

(Setting only)

Provided only for backward compatibility with other Rohde & Schwarz signal generators.

The R&S SMW200A accepts these values and maps them automatically as follows:

DBM3 = DBM2, DB3 = DB2

**AUTO**

Requires a connected R&S SZU. The R&S SMW200A automatically sets the gain with optimized adjustment data from the R&S SZU.

\*RST: DB4

**Example:**

```
SOURce1:BB:IQGain DB2
SOURce1:IQGain DB2
```

**Manual operation:** See "[Baseband Gain](#)" on page 470

**[:SOURce<hw>]:IQ:CREStfactor <CrestFactor>**

Specifies the crest factor for the external analog signal.

**Parameters:**

<CrestFactor> float  
 Range: 0 to 35  
 Increment: 0.01  
 \*RST: 0  
 Default unit: dB

**Example:**

```
IQ:CRESt 10
```

specifies 10 dB crest factor for the external analog signal.

**Manual operation:** See "[Crest Factor](#)" on page 469

---

**[ :SOURce<hw>]:IQ:SWAP[:STATe] <State>**

Swaps the I and Q channel.

**Parameters:**

<State>                    1 | ON | 0 | OFF  
 \*RST:                    0

**Example:**                    IQ:SWAP ON  
 swaps the I and Q channel.

**Manual operation:**    See "[I/Q Swap](#)" on page 468

---

**[ :SOURce<hw>]:IQ:WBState <WbState>**

Activates I/Q wideband mode.

Activation automatically optimizes the settings for wideband modulation signals with a bandwidth that is higher than 5 MHz.

**Parameters:**

<WbState>                    1 | ON | 0 | OFF  
 \*RST:  
 \*RST: 0 (R&S SMW-B10) / 1 (R&S SMW-B9)

**Example:**                    :SOURce1:IQ:WBST 1  
 Activates I/Q wideband mode.

**Manual operation:**    See "[I/Q Wideband](#)" on page 469

### 14.19.11 SOURce:IQ:OUTPut subsystem

The SOURce:IQ:OUTPut subsystem contains the commands for configuring I/Q output signals.

**Required options**

See the following sections:

- [Section 4.7, "I/Q digital output settings"](#), on page 164
- [Section 4.8, "I/Q analog output settings"](#), on page 176

**I/Q connectors and interfaces**

For information on the analog and digital I/Q connectors and interfaces, see:

[Table 4-4.](#)

- [SOURce:IQ:OUTPut:ANALog commands](#)..... 1213
- [SOURce:IQ:OUTPut:DIGital commands](#)..... 1217

### 14.19.11.1 SOURce:IQ:OUTPut:ANALog commands

This section describes the commands of the output of an analog I/Q signal.

#### Example: Enabling and configuring the analog output

```
SCONfiguration:OUTPut:MAPPING:IQOutput1:STReam1:STATe 1

SOURce1:IQ:OUTPut:ANALog:PRESet
SOURce1:IQ:OUTPut:ANALog:TYPE DIFF
SOURce1:IQ:OUTPut:ANALog:MODE VAR
SOURce1:IQ:OUTPut:LEVel 2
SOURce1:IQ:OUTPut:ANALog:BIAS:COUPling:STATe 1
SOURce1:IQ:OUTPut:ANALog:BIAS:I 1
SOURce1:IQ:OUTPut:ANALog:BIAS:Q?
// 1
SOURce1:IQ:OUTPut:ANALog:OFFSet:I 2
SOURce1:IQ:OUTPut:ANALog:OFFSet:Q 2.5
SOURce1:IQ:OUTPut:ANALog:STATe 1
```

#### Commands:

<code>[[:SOURce&lt;hw&gt;]:IQ:OUTPut:ANALog:STATe</code> .....	1213
<code>[[:SOURce&lt;hw&gt;]:IQ:OUTPut[:ANALog]:PRESet</code> .....	1214
<code>[[:SOURce&lt;hw&gt;]:IQ:OUTPut[:ANALog]:SETTing:CATalog?</code> .....	1214
<code>[[:SOURce&lt;hw&gt;]:IQ:OUTPut[:ANALog]:SETTing:STORE</code> .....	1214
<code>[[:SOURce&lt;hw&gt;]:IQ:OUTPut[:ANALog]:SETTing:LOAD</code> .....	1214
<code>[[:SOURce&lt;hw&gt;]:IQ:OUTPut[:ANALog]:SETTing:DELeTe</code> .....	1215
<code>[[:SOURce&lt;hw&gt;]:IQ:OUTPut[:ANALog]:TYPE</code> .....	1215
<code>[[:SOURce&lt;hw&gt;]:IQ:OUTPut[:ANALog]:MODE</code> .....	1215
<code>[[:SOURce&lt;hw&gt;]:IQ:OUTPut:LEVel</code> .....	1215
<code>[[:SOURce&lt;hw&gt;]:IQ:OUTPut[:ANALog]:BIAS:COUPling[:STATe]</code> .....	1216
<code>[[:SOURce&lt;hw&gt;]:IQ:OUTPut[:ANALog]:BIAS:I</code> .....	1216
<code>[[:SOURce&lt;hw&gt;]:IQ:OUTPut[:ANALog]:BIAS:Q</code> .....	1216
<code>[[:SOURce&lt;hw&gt;]:IQ:OUTPut[:ANALog]:OFFSet:I</code> .....	1217
<code>[[:SOURce&lt;hw&gt;]:IQ:OUTPut[:ANALog]:OFFSet:Q</code> .....	1217

---

#### `[[:SOURce<hw>]:IQ:OUTPut:ANALog:STATe <State>`

Activates the specified analog I/Q output.

**Note:** By default, the output connectors [I/Q Out x] are deactivated.

#### Suffix:

`:SOURce<hw>` 1|2  
Selects the [I/Q Out] connectors

#### Parameters:

`<State>` 1 | ON | 0 | OFF  
\*RST: 0

**Example:** SOURce:IQ:OUTPut:ANALog:STATe ON  
 Activates the output of the analog I/Q signal on the [I/Q Out 1] connectors.

**Manual operation:** See ["State"](#) on page 178

### **[ :SOURce<hw>]:IQ:OUTPut[:ANALog]:PRESet**

Sets the default settings (\*RST values specified for the commands).

Not affected are:

- The state set with the command [ :SOURce<hw>]:IQ:OUTPut:ANALog:STATe.
- If SCONfiguration:EXTernal:PBEHaviour 1, the I/Q ouptput type set with the command [ :SOURce<hw>]:IQ:OUTPut[:ANALog]:TYPE.

**Example:** See [Example "Enabling and configuring the analog output"](#) on page 1213.

**Usage:** Event

**Manual operation:** See ["Set To Default"](#) on page 178

### **[ :SOURce<hw>]:IQ:OUTPut[:ANALog]:SETTing:CATalog?**

Queries the files with I/Q output settings in the default directory. Listed are files with the file extension \*.iqout.

**Return values:**

<Catalog> string

**Usage:** Query only

**Manual operation:** See ["Save/Recall"](#) on page 179

### **[ :SOURce<hw>]:IQ:OUTPut[:ANALog]:SETTing:STORe <Filename>**

Stores the current settings into the selected file; the file extension (\*.iqout) is assigned automatically.

**Setting parameters:**

<Filename> "<filename>"  
 Filename or complete file path

**Usage:** Setting only

**Manual operation:** See ["Save/Recall"](#) on page 179

### **[ :SOURce<hw>]:IQ:OUTPut[:ANALog]:SETTing:LOAD <Filename>**

Loads the selected file from the default or the specified directory. Loaded are files with extension \*.iqout.

**Setting parameters:**

<Filename> "<filename>"  
 Filename or complete file path

**Usage:** Setting only

**Manual operation:** See ["Save/Recall"](#) on page 179

**[[:SOURce<hw>]:IQ:OUTPut[:ANALog]:SETTING:DELeTe <Filename>**

Deletes the selected file from the default or specified directory. Deleted are files with the file extension \*.iqout.

**Setting parameters:**

<Filename> "<filename>"  
 Filename or complete file path

**Usage:** Setting only

**Manual operation:** See ["Save/Recall"](#) on page 179

**[[:SOURce<hw>]:IQ:OUTPut[:ANALog]:TYPE <Type>**

Sets the type of the analog signal.

**Example:** SOURce1:IQ:OUTPut:ANALog:TYPE DIFFerential

**Options:** DIFFerential requires R&S SMW-K16

**Manual operation:** See ["I/Q Output Type"](#) on page 140

**[[:SOURce<hw>]:IQ:OUTPut[:ANALog]:MODE <Mode>**

Determines the mode for setting the output parameters.

**Parameters:**

<Mode> FIXEd | VARiable  
**FIXEd**  
 Locks the I/Q output settings  
**VARiable**  
 Unlocks the settings  
 \*RST: FIXEd

**Example:** See [Example "Enabling and configuring the analog output"](#) on page 1213.

**Manual operation:** See ["Mode"](#) on page 180

**[[:SOURce<hw>]:IQ:OUTPut:LEVel <Level>**

Sets the off-load voltage  $V_p$  of the analog I/Q signal output.

To keep the I/Q analog output power levels below the maximum input power level at your DUT, see ["Maximum overall output voltage"](#) on page 117.

Also, the value range depends on instrument settings, for example the modulation signal type and signal bandwidth.

For more information, refer to the specifications document.

**Parameters:**

<Level> float  
 Range: depends on settings  
 Increment: 1E-4  
 \*RST: 1  
 Default unit: V

**Example:** See [Example "Enabling and configuring the analog output"](#) on page 1213.

**Manual operation:** See ["I/Q Level Vp \(EMF\)"](#) on page 180

**[ :SOURce<hw> ] :IQ:OUTPut[:ANALog]:BIAS:COUPling[:STATe] <State>**

Couples the bias setting of the I and Q signal components.

**Parameters:**

<State> 1 | ON | 0 | OFF  
 \*RST: 0

**Example:** See [Example "Enabling and configuring the analog output"](#) on page 1213.

**Manual operation:** See ["Couple I/Q Bias"](#) on page 180

**[ :SOURce<hw> ] :IQ:OUTPut[:ANALog]:BIAS:I <I>**  
**[ :SOURce<hw> ] :IQ:OUTPut[:ANALog]:BIAS:Q <Q>**

Sets the amplifier bias  $V_{bias}$  of the I component or Q component.

To keep the I/Q analog output power levels below the maximum input power level at your DUT, see ["Maximum overall output voltage"](#) on page 117.

For more information, refer to the specifications document.

**Parameters:**

<Q> float  
 Range:  $(-4+V_p/2+V_{offset}/2),V$  to  $(4-V_p/2-V_{offset}/2),V$   
 (R&S SMW-B10) /  $-0.2V$  to  $2.5V$  (R&S SMW-B9)  
 Increment: 1E-4  
 \*RST: 0  
 Default unit: V

**Example:** See [Example "Enabling and configuring the analog output"](#) on page 1213.

**Manual operation:** See ["Bias \(EMF\)"](#) on page 181



**[ :SOURce<hw> ] :IQ:OUTPut[:ANALog]:OFFSet:I <I>**  
**[ :SOURce<hw> ] :IQ:OUTPut[:ANALog]:OFFSet:Q <Q>**

Sets an offset  $V_{\text{offset}}$  between the inverting and non-inverting input of the differential analog I/Q output signal.

To keep the I/Q analog output power levels below the maximum input power level at your DUT, see ["Maximum overall output voltage"](#) on page 117.

For more information, refer to the specifications document.

**Parameters:**

<Q> float  
 Range:  $(-4+V_p/2+V_{\text{bias}}/2),V$  to  $(4-V_p/2-V_{\text{bias}}/2),V$  (R&S SMW-B10) /  $(-2+V_p),V$  to  $(2-V_p),V$  (R&S SMW-B9)  
 Increment: 1E-4  
 \*RST: 0  
 Default unit: V

**Example:** See [Example "Enabling and configuring the analog output"](#) on page 1213.

**Manual operation:** See ["Offset \(EMF\)"](#) on page 181

#### 14.19.11.2 SOURce:IQ:OUTPut:DIGital commands

This section describes the commands of the output of a digital I/Q signal.

**Common suffixes**

The following suffixes are used:

Suffix	Value range	Description
BBMM<ch>	1 to 2	DIG I/Q connector Option: R&S SMW-B9/-K19: HS DIG I/Q connector See also <a href="#">Section 4.3.4, "Supported digital interfaces and system configuration"</a> , on page 113.
FADer<ch>	1 to 4 <sup>*)</sup>	Option: R&S SMW-B10 DIG I/Q connector <sup>*)</sup> The number of the available DIG I/Q connectors on the FADER boards depends on the selected configuration (see also <a href="#">:SCONfiguration:FADing</a> ).
CHANnel<ch0>	0 to 7	Option: R&S SMW-B9/-K19 Channel number Up to 8 channels per HS DIG I/Q interface and max. 8 channels for both interfaces.

**Example: Enabling and configuring the HS DIG I/Q digital outputs**

Option: R&S SMW-B9/-K19

```

SCONfiguration:MODE ADV
SCONfiguration:OUTPut:MODE HSD
SCONfiguration:FADing SISO4X1X1
SCONfiguration:BASEband:SOURce SEP
SCONfiguration:DIQ:BBMM1:CHANnels CH4
SCONfiguration:DIQ:BBMM2:CHANnels CH2
SCONfiguration:APPLy

SCONfiguration:OUTPut:MAPPING:BBMM1:CHANnel0:MODE ADD
SCONfiguration:OUTPut:MAPPING:BBMM1:CHANnel0:STReam2:STATe 1
SCONfiguration:OUTPut:MAPPING:BBMM1:CHANnel1:STReam2:STATe 0
SCONfiguration:OUTPut:MAPPING:BBMM1:CHANnel1:STReam2:STATe 1
SCONfiguration:OUTPut:MAPPING:BBMM1:CHANnel1:STReam2:STATe 0
SCONfiguration:OUTPut:MAPPING:BBMM2:CHANnel0:MODE ADD
SCONfiguration:OUTPut:MAPPING:BBMM1:CHANnel1:STReam2:STATe 1
SCONfiguration:OUTPut:MAPPING:BBMM2:CHANnel0:STReam1:STATe 1
SCONfiguration:OUTPut:MAPPING:BBMM2:CHANnel0:STReam2:STATe 1
SCONfiguration:OUTPut:MAPPING:BBMM2:CHANnel0:STReam3:STATe 1
SCONfiguration:OUTPut:MAPPING:BBMM2:CHANnel0:STReam4:STATe 1
SCONfiguration:OUTPut:MAPPING:BBMM2:CHANnel1:STReam4:STATe 1

SOURcel:IQ:OUTPut:DIgital:BBMM1:STATe 1
SOURcel:IQ:OUTPut:DIgital:BBMM1:COMMon:STATe 1
SOURcel:IQ:OUTPut:DIgital:BBMM1:SRATe 100000000
SOURcel:IQ:OUTPut:DIgital:BBMM1:CHANnel0:STATe 1
SOURcel:IQ:OUTPut:DIgital:BBMM1:CHANnel0:NAME "BBMM1_CH0"
SOURcel:IQ:OUTPut:DIgital:BBMM1:CHANnel0:SRATe?
// Respons in Hz: "100000000"
SOURcel:IQ:OUTPut:DIgital:BBMM1:CHANnel1:STATe 0
SOURcel:IQ:OUTPut:DIgital:BBMM1:CHANnel2:STATe 1
SOURcel:IQ:OUTPut:DIgital:BBMM1:CHANnel3:STATe 1
SOURcel:IQ:OUTPut:DIgital:BBMM1:SRATe:SUM?
// Respons in Hz: "300000000"
SOURcel:IQ:OUTPut:DIgital:BBMM1:SRATe:MAX?
// Respons in Hz: "125000000000"
SOURcel:IQ:OUTPut:DIgital:BBMM2:STATe 1
SOURcel:IQ:OUTPut:DIgital:BBMM2:COMMon:STATe 0
SOURcel:IQ:OUTPut:DIgital:BBMM2:CHANnel0:SRATe 250000000
SOURcel:IQ:OUTPut:DIgital:BBMM2:CHANnel0:STATe 1
SOURcel:IQ:OUTPut:DIgital:BBMM2:CHANnel1:SRATe 100000000
SOURcel:IQ:OUTPut:DIgital:BBMM2:CHANnel1:STATe 1
SOURcel:IQ:OUTPut:DIgital:BBMM1:SRATe:SUM?
// Respons in Hz: "350000000"
SOURcel:IQ:OUTPut:DIgital:BBMM1:SRATe:MAX?
// Respons in Hz: "125000000000"

```

**Commands:**

[:SOURce]:IQ:OUTPut:DiGital:BBMM<ch>:STATe.....	1219
[:SOURce]:IQ:OUTPut:DiGital:FADer<ch>:STATe.....	1219
[:SOURce]:IQ:OUTPut:DiGital:BBMM<ch>:INTerface.....	1220
[:SOURce]:IQ:OUTPut:DiGital:FADer<ch>:INTerface.....	1220
[:SOURce]:IQ:OUTPut:DiGital:BBMM<ch>:SLOW:STATe.....	1220
[:SOURce]:IQ:OUTPut:DiGital:BBMM<ch>:PON.....	1220
[:SOURce]:IQ:OUTPut:DiGital:FADer<ch>:PON.....	1220
[:SOURce]:IQ:OUTPut:DiGital:BBMM<ch>:SRATe:SOURce.....	1220
[:SOURce]:IQ:OUTPut:DiGital:FADer<ch>:SRATe:SOURce.....	1220
[:SOURce]:IQ:OUTPut:DiGital:BBMM<ch>:SRATe.....	1221
[:SOURce]:IQ:OUTPut:DiGital:FADer<ch>:SRATe.....	1221
[:SOURce]:IQ:OUTPut:DiGital:BBMM<ch>:CDEVice?.....	1222
[:SOURce]:IQ:OUTPut:DiGital:FADer<ch>:CDEVice?.....	1222
[:SOURce]:IQ:OUTPut:DiGital:FADer<ch>:POWer:VIA.....	1222
[:SOURce]:IQ:OUTPut:DiGital:BBMM<ch>:POWer:VIA.....	1222
[:SOURce]:IQ:OUTPut:DiGital:BBMM<ch>:CHANnel<st0>:POWer:PEP.....	1222
[:SOURce]:IQ:OUTPut:DiGital:BBMM<ch>:POWer:PEP.....	1222
[:SOURce]:IQ:OUTPut:DiGital:FADer<ch>:POWer:PEP.....	1222
[:SOURce]:IQ:OUTPut:DiGital:BBMM<ch>:CHANnel<st0>:POWer:LEVel.....	1223
[:SOURce]:IQ:OUTPut:DiGital:BBMM<ch>:POWer:LEVel.....	1223
[:SOURce]:IQ:OUTPut:DiGital:FADer<ch>:POWer:LEVel.....	1223
[:SOURce]:IQ:OUTPut:DiGital:BBMM<ch>:POWer:STEP:MODE.....	1223
[:SOURce]:IQ:OUTPut:DiGital:FADer<ch>:POWer:STEP:MODE.....	1223
[:SOURce]:IQ:OUTPut:DiGital:BBMM<ch>:POWer:STEP[:INCRement].....	1224
[:SOURce]:IQ:OUTPut:DiGital:FADer<ch>:POWer:STEP[:INCRement].....	1224
[:SOURce]:IQ:OUTPut:DiGital:BBMM<ch>:GDELay:CSTate.....	1224
[:SOURce]:IQ:OUTPut:DiGital:BBMM<ch>:OFLow:STATe?.....	1224
[:SOURce]:IQ:OUTPut:DiGital:FADer<ch>:OFLow:STATe?.....	1224
[:SOURce]:IQ:OUTPut:DiGital:BBMM<ch>:OFLow:HOLD:RESet.....	1224
[:SOURce]:IQ:OUTPut:DiGital:FADer<ch>:OFLow:HOLD:RESet.....	1224
[:SOURce]:IQ:OUTPut:DiGital:BBMM<ch>:OFLow:HOLD:STATe?.....	1225
[:SOURce]:IQ:OUTPut:DiGital:FADer<ch>:OFLow:HOLD:STATe?.....	1225
[:SOURce]:IQ:OUTPut:DiGital:BBMM<ch>:SRATe:COMMon:STATe.....	1225
[:SOURce]:IQ:OUTPut:DiGital:BBMM<ch>:CHANnel<st0>:NAME.....	1225
[:SOURce]:IQ:OUTPut:DiGital:BBMM<ch>:CHANnel<st0>:SRATe.....	1226
[:SOURce]:IQ:OUTPut:DiGital:BBMM<ch>:CHANnel<st0>:POWer:PEP.....	1226
[:SOURce]:IQ:OUTPut:DiGital:BBMM<ch>:CHANnel<st0>:POWer:LEVel.....	1226
[:SOURce]:IQ:OUTPut:DiGital:BBMM<ch>:CHANnel<st0>:STATe.....	1227
[:SOURce]:IQ:OUTPut:DiGital:BBMM<ch>:SRATe:SUM?.....	1227
[:SOURce]:IQ:OUTPut:DiGital:BBMM<ch>:SRATe:MAX?.....	1227

---

**[:SOURce]:IQ:OUTPut:DiGital:BBMM<ch>:STATe <State>**

**[:SOURce]:IQ:OUTPut:DiGital:FADer<ch>:STATe <State>**

Activates the digital I/Q signal output.

**Parameters:**

<State>                    1 | ON | 0 | OFF  
 \*RST:                    0

**Example:**               SOURce:IQ:OUTPut:DIGital:BBMM2:STATe ON  
 Activates the [BBMM 2] output connector.

**Manual operation:** See "State" on page 168

**[:SOURce]:IQ:OUTPut:DIGital:BBMM<ch>:INTerface <BboutInterfMode>**  
**[:SOURce]:IQ:OUTPut:DIGital:FADer<ch>:INTerface <BboutInterfMode>**

Selects the connector for output of the digital IQ signal.

**Parameters:**

<BboutInterfMode>   DIGital | HSDin  
                           **DIGital**  
                           DIG I/Q  
                           **HSDin**  
                           HS DIG I/Q  
 \*RST:                DIN

**[:SOURce]:IQ:OUTPut:DIGital:BBMM<ch>:SLOW:STATe <SlowIqState>**

Enables/disables slow IQ mode.

See user manual R&S SMW-K551 Generation of Digital "Slow IQ" Signals.

**Parameters:**

<SlowIqState>       1 | ON | 0 | OFF  
 \*RST:                0

**Options:**               R&S SMW-K551

**Manual operation:** See "Slow IQ State" on page 168

**[:SOURce]:IQ:OUTPut:DIGital:BBMM<ch>:PON <Pon>**

**[:SOURce]:IQ:OUTPut:DIGital:FADer<ch>:PON <Pon>**

Sets the power-on state of the selected digital I/Q output.

**Parameters:**

<Pon>                 OFF | UNCHanged  
 \*RST:                UNCHanged

**Example:**               :SOURce:IQ:OUTPut:DIGital:BBMM2:PON OFF  
 Deactivates the [BBMM 2] output connector when the instrument is switched on.

**Manual operation:** See "Power-On State" on page 175

**[:SOURce]:IQ:OUTPut:DIGital:BBMM<ch>:SRATe:SOURce <Source>**

**[:SOURce]:IQ:OUTPut:DIGital:FADer<ch>:SRATe:SOURce <Source>**

Selects whether the sample rate is estimated based on the digital signal or is a user-defined value.

**Parameters:****<Source>** USER | DOUT**DOUT**

Enabled for BBMM1|BBMM2 connectors

**\*RST:** USER**Example:**:SOURce:IQ:OUTPut:DIGital:BBMM2:SRATe:SOURce  
DOUT

Sample rate estimation based on the applied I/Q data clock

:SOURce:IQ:OUTPut:DIGital:BBMM2:SRATe?

**Manual operation:** See "[Source](#)" on page 169**[[:SOURce]:IQ:OUTPut:DIGital:BBMM<ch>:SRATe <SRate>**

Sets the sample rate of the digital I/Q output signal.

**Parameters:****<SRate>** float

Range: 400 to depends on options

Increment: 0.001

**\*RST:** 100E6

Default unit: Hz

The maximum value depends on the installed options as follows:  
R&S SMW-B10: max = 200E6 and depends on the connected  
receiving deviceR&S SMW-B9: system clock depending on the system configu-  
ration and fader configurationSee also [Section 4.3.4, "Supported digital interfaces and system  
configuration"](#), on page 113.**Example:**See [\[:SOURce\]:IQ:OUTPut:DIGital:FADer<ch>:SRATe:  
SOURce](#) on page 1220.**Manual operation:** See "[Value](#)" on page 169**[[:SOURce]:IQ:OUTPut:DIGital:FADer<ch>:SRATe <SRate>**

Sets/queries the sample rate of the digital I/Q output signal.

**Parameters:****<SRate>** float

Range: 0.5E6 to depends on options

Increment: 0.5E6

\*RST: 100E6

Default unit: Hz

The maximum value depends on the installed options as follows:  
R&S SMW-B10: max = 200E6 and depends on the connected receiving device

R&amp;S SMW-B9: max = 250E6

See also [Section 4.3.4, "Supported digital interfaces and system configuration"](#), on page 113.**Example:**See `[ :SOURce ] : IQ : OUTPut : DIGital : FADer <ch> : SRATe : SOURce` on page 1220.**Manual operation:** See ["Value"](#) on page 169**[ :SOURce ] : IQ : OUTPut : DIGital : BBMM <ch> : CDEvice ?****[ :SOURce ] : IQ : OUTPut : DIGital : FADer <ch> : CDEvice ?**

Queries information on the connected device.

**Return values:****<CDevice>** string**Example:**`:SOURce : IQ : OUTPut : DIGital : BBMM2 : CDEvice ?`**Usage:**

Query only

**Manual operation:** See ["Connected Device"](#) on page 169**[ :SOURce ] : IQ : OUTPut : DIGital : FADer <ch> : POWER : VIA <Via>****[ :SOURce ] : IQ : OUTPut : DIGital : BBMM <ch> : POWER : VIA <Via>**

Selects the respective level entry field for the I/Q output.

**Parameters:****<Via>** PEP | LEVeI

\*RST: PEP

**Manual operation:** See ["Set Level Via"](#) on page 173**[ :SOURce ] : IQ : OUTPut : DIGital : BBMM <ch> : CHANnel <st0> : POWER : PEP****<BboutPepHs>****[ :SOURce ] : IQ : OUTPut : DIGital : BBMM <ch> : POWER : PEP <Pep>****[ :SOURce ] : IQ : OUTPut : DIGital : FADer <ch> : POWER : PEP <Pep>**

Enters the peak level of the output signal relative to full scale of 0.5 V (in terms of dB full scale).

**Parameters:**

<Pep> float  
 Range: -80 to 0  
 Increment: 0.01  
 \*RST: 0

**Example:** :SOURce:IQ:OUTPut:DiGital:BBMM2:POWer:PEP -10

**Manual operation:** See "[Peak Level](#)" on page 171

**[[:SOURce]:IQ:OUTPut:DiGital:BBMM<ch>:CHANnel<st0>:POWer:LEVel  
 <BboutHsLevel>**

**[[:SOURce]:IQ:OUTPut:DiGital:BBMM<ch>:POWer:LEVel <Level>**

**[[:SOURce]:IQ:OUTPut:DiGital:FADer<ch>:POWer:LEVel <Level>**

Enters the RMS level of the output signal.

**Parameters:**

<Level> float  
 Range: -80 to 0  
 Increment: 0.01  
 \*RST: 0

**Example:** SOURce:IQ:OUTPut:DiGital:BBMM2:POWer:LEVel -10

**Manual operation:** See "[Level](#)" on page 171

**[[:SOURce]:IQ:OUTPut:DiGital:BBMM<ch>:POWer:STEP:MODE <Mode>**

**[[:SOURce]:IQ:OUTPut:DiGital:FADer<ch>:POWer:STEP:MODE <Mode>**

Defines the type of step size to vary the digital output power step-by-step.

**Parameters:**

<Mode> DECimal | USER

**DECimal**

increases or decreases the level in steps of ten.

**USER**

increases or decreases the level in increments, determined with the command `[[:SOURce]:IQ:OUTPut:DiGital:FADer<ch>:POWer:STEP[:INCRement]`.

\*RST: DECimal

**Example:** :SOURce:IQ:OUTPut:DiGital:BBMM2:POWer:STEP:MODE  
 USER

:SOURce:IQ:OUTPut:DiGital:BBMM2:POWer:STEP 5 dB

Activates the step width for level variation in 5 dB steps

**Manual operation:** See "[User Variation](#)" on page 174

---

```
[ :SOURce]:IQ:OUTPut:DIGital:BBMM<ch>:POWer:STEP[:INCRement]
<Increment>
```

```
[ :SOURce]:IQ:OUTPut:DIGital:FADer<ch>:POWer:STEP[:INCRement] <Increment>
```

Sets the step width. Use this value to vary the digital I/Q output level step-by-step.

**Parameters:**

```
<Increment>      float
                  Range:    0 to 80
                  Increment: 0.01
                  *RST:     1
```

**Example:** See `[ :SOURce]:IQ:OUTPut:DIGital:FADer<ch>:POWer:STEP:MODE` on page 1223

**Manual operation:** See ["User Variation"](#) on page 174

---

```
[ :SOURce]:IQ:OUTPut:DIGital:BBMM<ch>:GDELay:CState <CompState>
```

Enables/disables group delay compensation.

**Parameters:**

```
<CompState>      1 | ON | 0 | OFF
                  *RST:    0
```

**Example:** `SOURce:IQ:OUTPut:DIGital:BBMM1:GDELay:CState 1`

**Manual operation:** See ["Group Delay Compensation"](#) on page 175

---

```
[ :SOURce]:IQ:OUTPut:DIGital:BBMM<ch>:OFLow:STATe?
```

```
[ :SOURce]:IQ:OUTPut:DIGital:FADer<ch>:OFLow:STATe?
```

Queries whether the I/Q output signal is clipped or not.

**Return values:**

```
<State>          1 | ON | 0 | OFF
                  *RST:    0
```

**Example:**

```
SOURce:IQ:OUTPut:DIGital:BBMM2:OFLow:STATe?
// 0
// no overflow
```

**Usage:** Query only

**Options:** R&S SMW-B10

**Manual operation:** See ["Signal Monitoring"](#) on page 174

---

```
[ :SOURce]:IQ:OUTPut:DIGital:BBMM<ch>:OFLow:HOLD:RESet
```

```
[ :SOURce]:IQ:OUTPut:DIGital:FADer<ch>:OFLow:HOLD:RESet
```

Resets the overflow hold state and LED.

**Example:** `SOURce:IQ:OUTPut:DIGital:BBMM2:OFLow:HOLD:RESet`



**Usage:** Event  
**Options:** R&S SMW-B10  
**Manual operation:** See "[Signal Monitoring](#)" on page 174

**[[:SOURce]:IQ:OUTPut:DIGital:BBMM<ch>:OFLow:HOLD:STATe?  
[:SOURce]:IQ:OUTPut:DIGital:FADer<ch>:OFLow:HOLD:STATe?**

Queries an overload since last reset for evaluating the measurement.

**Return values:**

<State> 1 | ON | 0 | OFF  
\*RST: 0

**Example:** SOURce:IQ:OUTPut:DIGital:BBMM2:OFLow:HOLD:  
STATe?

**Usage:** Query only  
**Options:** R&S SMW-B10  
**Manual operation:** See "[Signal Monitoring](#)" on page 174

**[[:SOURce]:IQ:OUTPut:DIGital:BBMM<ch>:SRATe:COMMon:STATe  
<DigIqHsComState>**

If enabled, the same sample rate value is applied to all channels.

**Parameters:**

<DigIqHsComState> 1 | ON | 0 | OFF

**Example:** See [Example "Enabling and configuring the HS DIG I/Q digital outputs"](#) on page 1217.

**Options:** R&S SMW-K19

**[[:SOURce]:IQ:OUTPut:DIGital:BBMM<ch>:CHANnel<st0>:NAME  
<DigIqHsCHName>**

Sets the channel name.

**Parameters:**

<DigIqHsCHName> string

**Example:** See [Example "Enabling and configuring the HS DIG I/Q digital outputs"](#) on page 1217.

**Options:** R&S SMW-K19

**Manual operation:** See "[Name](#)" on page 170

---

```
[[:SOURce]:IQ:OUTPut:DIGital:BBMM<ch>:CHANnel<st0>:SRATe
  <DigIqHsSratChan>
```

Sets the sample rate per channel.

**Parameters:**

```
<DigIqHsSratChan> float
                    Range:    400 to max*
                    Increment: 0.001
                    *RST:    100E6
                    *) max = 250E6 ("System Config > Mode = Advanced")/ max =
                    1250E6 ("System Config > Mode = Standard")
                    See also Section 4.3.4, "Supported digital interfaces and system
                    configuration", on page 113.
```

**Example:** See [Example "Enabling and configuring the HS DIG I/Q digital outputs"](#) on page 1217.

**Options:** R&S SMW-K19

**Manual operation:** See ["Sample Rate"](#) on page 171

---

```
[[:SOURce]:IQ:OUTPut:DIGital:BBMM<ch>:CHANnel<st0>:POWER:PEP
  <BboutPepHs>
```

The level is relative to full scale of 0.5 V (in terms of dB full scale).

**Parameters:**

```
<BboutPepHs> float
              Range:    -80 to 0
              Increment: 0.01
              *RST:    0
```

**Example:** See [Example "Enabling and configuring the HS DIG I/Q digital outputs"](#) on page 1217.

**Manual operation:** See ["Peak Level"](#) on page 171

---

```
[[:SOURce]:IQ:OUTPut:DIGital:BBMM<ch>:CHANnel<st0>:POWER:LEVel
  <BboutHsLevel>
```

The level is relative to full scale of 0.5 V (in terms of dB full scale).

**Parameters:**

```
<BboutHsLevel> float
              Range:    -80 to 0
              Increment: 0.01
              *RST:    0
```

**Example:** See [Example "Enabling and configuring the HS DIG I/Q digital outputs"](#) on page 1217.

**Manual operation:** See ["Level"](#) on page 171

---

```
[[:SOURce]:IQ:OUTPut:DIGital:BBMM<ch>:CHANnel<st0>:STATe  
  <DigIqHsOutChSta>
```

Enables the channel.

**Parameters:**

```
<DigIqHsOutChSta> 1 | ON | 0 | OFF  
*RST: 1
```

**Example:** See [Example "Enabling and configuring the HS DIG I/Q digital outputs"](#) on page 1217.

**Options:** R&S SMW-K19

**Manual operation:** See ["Active"](#) on page 172

---

```
[[:SOURce]:IQ:OUTPut:DIGital:BBMM<ch>:SRATe:SUM?  
[[:SOURce]:IQ:OUTPut:DIGital:BBMM<ch>:SRATe:MAX?
```

Queries the maximum supported sample rate.

**Return values:**

```
<DigIqHsInSRMax> integer  
Range: 1050E6 to 1250E6  
*RST: 1050E6
```

**Example:** See [Example "Enabling and configuring the HS DIG I/Q digital outputs"](#) on page 1217.

**Usage:** Query only

**Options:** R&S SMW-K19

**Manual operation:** See ["Aggregated Link Sample Rate"](#) on page 172

### 14.19.12 SOURce:LFOutput subsystem

The SOURce:LFOutput subsystem contains the commands for setting the LF signal source in CW and Sweep mode and for analog modulation.

**Example: Setup an LF sweep**

The following example shows a command sequence to set up an LF sweep.

```
// Reset the instrument to start from an initial state  
*RST; *CLS  
  
// Set the trigger mode, the sweep mode and the sweep range  
TRIGger1:LFFSweep:SOURce SINGLE  
SOURce1:LFOutput1:SWEep:FREQuency:MODE AUTO  
SOURce1:LFOutput1:FREQuency:START 1 kHz  
SOURce1:LFOutput1:FREQuency:STOP 7 kHz
```

```

// Select linear spacing
// Select the waveform shape for the frequency sweep cycle
// Set the step width and the dwell time.
SOURcel:LFOOutput1:SWEep:FREQuency:SPACing LINear
SOURcel:LFOOutput1:SWEep:FREQuency:SHApe SAWtooth
SOURcel:LFOOutput1:SWEep:FREQuency:STEP:LINear 100 Hz
SOURcel:LFOOutput1:SWEep:FREQuency:DWELL 150 ms
// Alternatively to the step width set the number of steps
SOURcel:LFOOutput1:SWEep:FREQuency:POINts 61

// Activate change to start frequency while waiting for next trigger
// Prerequisites: sweep mode single and sweep waveform sawtooth
SOURcel:LFOOutput:SWEep:FREQuency:RETRace 1

// Activate the LF frequency sweep
SOURcel:LFOOutput:FREQuency:MODE SWE

// Trigger the sweep (depending on the set mode) and query the status
// Perform a one-off LF sweep
SOURcel:LFOOutput1:SWEep:FREQuency:EXECute
SOURcel:LFOOutput1:SWEep:FREQuency:RUNning?
// 1
// the sweep is running

// *****
// For manual step LF sweep use the following commands
*RST; *CLS
SOURcel:LFOOutput:SWEep:FREQuency:MODE MANual
// Activate the LF frequency sweep
SOURcel:LFOOutput:FREQuency:MODE SWEep
// Activate LF Output1.
SOURcel:LFOOutput1:STATe 1
// Input the frequency manually for each step
SOURcel:LFOOutput1:FREQuency:MANual 2 kHz
SOURcel:LFOOutput1:FREQuency:MANual 2.1 kHz
// Alternatively use UP or DOWN parameter with set step width.
SOURcel:LFOOutput1:SWEep:FREQuency:STEP:LINear 500 Hz
SOURcel:LFOOutput1:FREQuency:MANual UP

```

### Example: Configuring the LF generator

The following is a simple example on how to configure the LF generator and output the generated signal.

```

// configure the signal of the LF1 generator
SOURcel:LFOOutput1:SHApe SQU
SOURcel:LFOOutput1:SHApe:PULSe:PERiod 0.001
SOURcel:LFOOutput1:SHApe:PULSe:WIDTh 0.0005
SOURcel:LFOOutput1:SHApe:PULSe:DCYCLE 0.5
// configure the signal of the LF1 generator
SOURcel:LFOOutput2:SHApe SINE

```

```

SOURCE1:LFOutput2:FREQuency 1000000
SOURCE1:LFOutput2:PERiod?
// 0.000001

// changing the LF signal shape
// SOURCE1:LFOutput2:SHAPE TRAP
// SOURCE1:LFOutput2:SHAPE:PULSE:PERiod 0.2
// SOURCE1:LFOutput2:SHAPE:TRAPeZe:RISE 0.0001
// SOURCE1:LFOutput2:SHAPE:TRAPeZe:FALL 0.001
// SOURCE1:LFOutput2:SHAPE:TRAPeZe:FALL 0.0001
// SOURCE1:LFOutput2:SHAPE:TRAPeZe:HIGH 0.0005
// SOURCE1:LFOutput2:SHAPE TRI
// SOURCE1:LFOutput2:SHAPE:PULSE:PERiod 0.1
// SOURCE1:LFOutput2:SHAPE:TRIangle:RISE 0.0001

// activate the LF output and select the LF1 as signal source
// configure the LF output signal
SOURCE1:LFOutput1:FREQuency:MODE CW
SOURCE1:LFOutput1:STATE 1
SOURCE1:LFOutput1:SOURCE LF1
SOURCE1:LFOutput1:INTernal:VOLTage 1
SOURCE1:LFOutput1:OFFSet 0.001

```

- [LF generator settings](#)..... 1229
- [LF sweep settings](#)..... 1236

#### 14.19.12.1 LF generator settings

With the commands described in this section, you can configure the LF signal source.

<a href="#">[:SOURCE]:LFOutput&lt;ch&gt;:BANDwidth?</a> .....	1230
<a href="#">[:SOURCE&lt;hw&gt;]:LFOutput&lt;ch&gt;:FREQuency</a> .....	1230
<a href="#">[:SOURCE&lt;hw&gt;]:LFOutput&lt;ch&gt;:PERiod?</a> .....	1230
<a href="#">[:SOURCE&lt;hw&gt;]:LFOutput:FREQuency:MANual</a> .....	1231
<a href="#">[:SOURCE&lt;hw&gt;]:LFOutput:FREQuency:MODE</a> .....	1231
<a href="#">[:SOURCE&lt;hw&gt;]:LFOutput:FREQuency:STOP</a> .....	1232
<a href="#">[:SOURCE&lt;hw&gt;]:LFOutput:FREQuency:START</a> .....	1232
<a href="#">[:SOURCE]:LFOutput&lt;ch&gt;[:STATE]</a> .....	1232
<a href="#">[:SOURCE]:LFOutput&lt;ch&gt;:OFFSet</a> .....	1232
<a href="#">[:SOURCE]:LFOutput&lt;ch&gt;:SOURCE</a> .....	1233
<a href="#">[:SOURCE]:LFOutput&lt;ch&gt;:SOURCE:PATH</a> .....	1233
<a href="#">[:SOURCE]:LFOutput&lt;ch&gt;:VOLTage</a> .....	1233
<a href="#">[:SOURCE&lt;hw&gt;]:LFOutput&lt;ch&gt;:SHAPE</a> .....	1234
<a href="#">[:SOURCE&lt;hw&gt;]:LFOutput&lt;ch&gt;:SHAPE:PULSE:DCYCLE</a> .....	1234
<a href="#">[:SOURCE&lt;hw&gt;]:LFOutput&lt;ch&gt;:SHAPE:PULSE:PERiod</a> .....	1234
<a href="#">[:SOURCE&lt;hw&gt;]:LFOutput&lt;ch&gt;:SHAPE:PULSE:WIDTH</a> .....	1234
<a href="#">[:SOURCE&lt;hw&gt;]:LFOutput&lt;ch&gt;:SHAPE:TRAPeZe:FALL</a> .....	1235
<a href="#">[:SOURCE&lt;hw&gt;]:LFOutput&lt;ch&gt;:SHAPE:TRAPeZe:HIGH</a> .....	1235
<a href="#">[:SOURCE&lt;hw&gt;]:LFOutput&lt;ch&gt;:SHAPE:TRAPeZe:PERiod</a> .....	1235

```
[:SOURce<hw>]:LFOutput<ch>:SHAPE:TRAPeze:RISE..... 1235
[:SOURce<hw>]:LFOutput<ch>:SHAPE:TRiangle:PERiod..... 1236
[:SOURce<hw>]:LFOutput<ch>:SHAPE:TRiangle:RISE..... 1236
```

---

### **[:SOURce]:LFOutput<ch>:BANDwidth?**

Queries the bandwidth of the external LF signal.

#### **Return values:**

```
<Bandwidth>      BW0M2 | BW10m
                  *RST:      BW10m
```

#### **Example:**

```
LFO:BAND?
// BW10m
// the bandwidth of the externally supplied LF signal is 10 MHz
```

**Usage:** Query only

**Manual operation:** See "[Bandwidth](#)" on page 574

---

### **[:SOURce<hw>]:LFOutput<ch>:FREQuency <Frequency>**

Sets the frequency of the LF signal in `[:SOURce<hw>]:LFOutput:FREQuency:MODE` CW | FIXEd mode.

#### **Note:**

- If the LF generator is used as a signal source, the instrument performs the analog modulations (AM/FM/ΦM/PM) with this frequency.
- In sweep mode (`[:SOURce<hw>]:LFOutput:FREQuency:MODE` SWE), the frequency is coupled with the sweep frequency.

#### **Parameters:**

```
<Frequency>      float
                  Range:      0.1 to depends on the installed options
                              (R&S SMW-K24)
                  Increment:  0.01
                  *RST:      1000
                  Default unit: Hz
```

**Example:** See [Example "Configuring the LF generator"](#) on page 1228.

**Manual operation:** See "[Frequency](#)" on page 572

---

### **[:SOURce<hw>]:LFOutput<ch>:PERiod?**

Queries the repetition frequency of the sine signal.

**Return values:**

<LfSinePeriod> float  
 Range: 1E-6 to 100  
 Increment: 10E-9  
 \*RST: 0.001  
 Default unit: s

**Example:** See [Example "Configuring the LF generator"](#) on page 1228.

**Usage:** Query only

**[ :SOURce<hw> ]:LFOutput:FREQUENCY:MANual <Manual>**

Sets the frequency of the subsequent sweep step if `LFO:SWE:MODE MAN`.

Use a separate command for each sweep step.

**Parameters:**

<Manual> float  
 You can select any value within the setting range, where:  
 START is set with `[ :SOURce<hw> ]:LFOutput:FREQUENCY:START`  
 STOP is set with `[ :SOURce<hw> ]:LFOutput:FREQUENCY:STOP`  
 Range: START to STOP  
 Increment: 0.1  
 \*RST: 1000

**Example:** See [Example "Setup an LF sweep"](#) on page 1227.

**Manual operation:** See ["Current Frequency"](#) on page 527

**[ :SOURce<hw> ]:LFOutput:FREQUENCY:MODE <Mode>**

Sets the mode for the output of the LF generator frequency, and determines the commands to be used for frequency settings.

**Parameters:**

<Mode> CW | FIXed | SWEep  
**CW|FIXed**  
 Sets the fixed-frequency mode. CW and FIXed are synonyms.  
 To set the output frequency, use command `[ :SOURce<hw> ]:LFOutput<ch>:FREQUENCY`  
**SWEep**  
 Sets sweep mode.  
 To set the frequency, use the commands:  
`[ :SOURce<hw> ]:LFOutput:FREQUENCY:START` and `[ :SOURce<hw> ]:LFOutput:FREQUENCY:STOP`  
 Or `[ :SOURce<hw> ]:LFOutput:FREQUENCY:MANual`  
 \*RST: CW

**Example:** See [Example "Setup an LF sweep"](#) on page 1227.

**Manual operation:** See ["State \(LF frequency sweep\)"](#) on page 527

```
[ :SOURce<hw>]:LFOutput:FREQUENCY:STOP <Stop>
[ :SOURce<hw>]:LFOutput:FREQUENCY:START <Start>
```

Sets the start/stop frequency for [ :SOURce<hw>]:LFOutput:FREQUENCY:MODE SWEEP.

**Parameters:**

<Start> float  
 Range: 0.1 Hz to 1 MHz  
 Increment: 0.1  
 \*RST: 1 KHz

**Example:** See [Example "Setup an LF sweep"](#) on page 1227.

**Manual operation:** See ["Start Frequency/Stop Frequency"](#) on page 531

```
[ :SOURce]:LFOutput<ch>[:STATe] <State>
```

Activates LF signal output.

**Parameters:**

<State> 1 | ON | 0 | OFF  
 \*RST: 0

**Example:** See [Example "Configuring the LF generator"](#) on page 1228.

**Manual operation:** See ["State"](#) on page 576

```
[ :SOURce]:LFOutput<ch>:OFFSet <Offset>
```

Sets a DC offset at the selected LF Output.

**Parameters:**

<Offset> float  
 Range: -3.6 to 3.6  
 Increment: 2E-3  
 \*RST: 0  
 Default unit: V

**Example:** See [Example "Configuring the LF generator"](#) on page 1228.

**Manual operation:** See ["DC-Offset"](#) on page 577



---

**[[:SOURce]:LFOutput<ch>:SOURce <Source>**

Determines the LF signal to be synchronized, when monitoring is enabled.

**Parameters:**

<Source>            LF1 | LF2 | NOISe | AM | FMPM | EXT1 | | EXT2 | LF1B | LF2B |  
 AMB | NOISB | FMPMB | LF1A | LF2A | NOISA | FMPMA | AMA  
**LF1|LF2|LF1A|LF2A|LF1B|LF2B**  
 Selects an internally generated LF signal.  
**NOISe|NOISA|NOISB**  
 Selects an internally generated noise signal.  
**EXT1|EXT2**  
 Selects an externally supplied LF signal  
**AM|AMA|AMB**  
 Selects the AM signal.  
**FMPM|FMPMA|FMPMB**  
 Selects the signal also used by the frequency or phase modulations.  
 \*RST:            LF1

**Example:**            See [Example "Configuring the LF generator"](#) on page 1228.

**Manual operation:** See ["Source"](#) on page 576

---

**[[:SOURce]:LFOutput<ch>:SOURce:PATH <SourPath>**

Determines the path of the LF output source.

**Parameters:**

<SourPath>            A | B  
 \*RST:            A

**Example:**            LFO:SOUR:PATH?  
 Queries the currently set path for the LF output signal source.

---

**[[:SOURce]:LFOutput<ch>:VOLTage <Voltage>**

Sets the output voltage of the selected LF output.

You can use this parameter when you have two LF generators activated.

**Parameters:**

<Voltage>            float  
 Range:            dynamic (see data sheet)  
 Increment:        0.001  
 \*RST:            1  
 Default unit: V

**Example:**            SOURce:LFOutput1:VOLTage 1.5

**Manual operation:** See ["Output Voltage"](#) on page 576

---

---

**[ :SOURce<hw>]:LFOuTput<ch>:SHAPE <Shape>**

Selects the waveform shape of the LF signal.

**Parameters:**

<Shape> SINE | SQUare | PULSe | TRIangle | TRAPeZe  
\*RST: SINE

**Example:** See [Example "Configuring the LF generator"](#) on page 1228.

**Options:** R&S SMW-K24

**Manual operation:** See ["Shape"](#) on page 572

---

**[ :SOURce<hw>]:LFOuTput<ch>:SHAPE:PULSe:DCYCLE <DCycle>**

Sets the duty cycle for the shape pulse.

**Parameters:**

<DCycle> float  
Range: 1E-6 to 100  
Increment: 1E-6  
\*RST: 50  
Default unit: PCT

**Example:** See [Example "Configuring the LF generator"](#) on page 1228.

**Manual operation:** See ["Pulse Duty Cycle"](#) on page 572

---

**[ :SOURce<hw>]:LFOuTput<ch>:SHAPE:PULSe:PERiod <Period>**

Sets the period of the generated pulse. The period determines the repetition frequency of the internal signal.

**Parameters:**

<Period> float  
Range: 1E-6 to 100  
Increment: 1E-8  
\*RST: 1E-3

**Example:** See [Example "Configuring the LF generator"](#) on page 1228.

**Manual operation:** See ["Period"](#) on page 572

---

**[ :SOURce<hw>]:LFOuTput<ch>:SHAPE:PULSe:WIDTh <Width>**

Sets the pulse width of the generated pulse.

**Parameters:**

<Width> float  
Range: 1E-6 to 100  
Increment: 1E-8  
\*RST: 5E-4

**Example:** See [Example "Configuring the LF generator"](#) on page 1228.

**Manual operation:** See ["Pulse Width"](#) on page 572

**[:SOURce<hw>]:LFOutput<ch>:SHAPE:TRAPeZe:FALL <Fall>**

Selects the fall time for the trapezoid shape of the LF generator.

**Parameters:**

<Fall>	float
	Range: 1E-6 to 100
	Increment: 10E-9
	*RST: 250E-6

**Example:** See [Example "Configuring the LF generator"](#) on page 1228.

**Manual operation:** See ["Trapezoid Rise / Fall"](#) on page 573

**[:SOURce<hw>]:LFOutput<ch>:SHAPE:TRAPeZe:HIGH <High>**

Sets the high time for the trapezoid signal of the LF generator.

**Parameters:**

<High>	float
	Range: 1E-6 to 100
	Increment: 10E-9
	*RST: 250E-6

**Example:** See [Example "Configuring the LF generator"](#) on page 1228.

**Manual operation:** See ["Trapezoid High"](#) on page 573

**[:SOURce<hw>]:LFOutput<ch>:SHAPE:TRAPeZe:PERiod <Period>**

Sets the period of the generated trapezoid shape. The period determines the repetition frequency of the internal signal.

**Parameters:**

<Period>	float
	Range: 1E-6 to 100
	Increment: 1E-8
	*RST: 1E-3

**Example:** See [Example "Configuring the LF generator"](#) on page 1228.

**Manual operation:** See ["Period"](#) on page 572

**[:SOURce<hw>]:LFOutput<ch>:SHAPE:TRAPeZe:RISE <Rise>**

Selects the rise time for the trapezoid shape of the LF generator.

**Parameters:**

<Rise>	float
Range:	1E-6 to 100
Increment:	10E-9
*RST:	250E-6

**Example:** See [Example "Configuring the LF generator"](#) on page 1228.

**Manual operation:** See ["Trapezoid Rise / Fall"](#) on page 573

**[:SOURce<hw>]:LFOutput<ch>:SHAPE:TRiangle:PERiod <Period>**

Sets the period of the generated pulse. The period determines the repetition frequency of the internal signal.

**Parameters:**

<Period>	float
Range:	1E-6 to 100
Increment:	10E-9
*RST:	0.001

**Example:** See [Example "Configuring the LF generator"](#) on page 1228.

**Manual operation:** See ["Period"](#) on page 572

**[:SOURce<hw>]:LFOutput<ch>:SHAPE:TRiangle:RISE <Rise>**

Selects the rise time for the triangle single of the LF generator.

**Parameters:**

<Rise>	float
Range:	1E-6 to 100
Increment:	10E-9
*RST:	0.5E-3

**Example:** See [Example "Configuring the LF generator"](#) on page 1228.

**Manual operation:** See ["Triangle Rise"](#) on page 573

### 14.19.12.2 LF sweep settings

With the commands described in this section, you can configure the sweep of the LF signal.

<a href="#">[:SOURce&lt;hw&gt;]:LFOutput:SWEep[:FREQUENCY]:DWELI</a> .....	1237
<a href="#">[:SOURce&lt;hw&gt;]:LFOutput:SWEep[:FREQUENCY]:EXECute</a> .....	1237
<a href="#">[:SOURce&lt;hw&gt;]:LFOutput:SWEep[:FREQUENCY]:MODE</a> .....	1237
<a href="#">[:SOURce&lt;hw&gt;]:LFOutput:SWEep[:FREQUENCY]:POINts</a> .....	1238
<a href="#">[:SOURce&lt;hw&gt;]:LFOutput:SWEep[:FREQUENCY]:RETRace</a> .....	1238
<a href="#">[:SOURce&lt;hw&gt;]:LFOutput:SWEep[:FREQUENCY]:RUNNing?</a> .....	1238
<a href="#">[:SOURce&lt;hw&gt;]:LFOutput:SWEep[:FREQUENCY]:SHAPE</a> .....	1239

<code>[ :SOURce&lt;hw&gt;]:LFOutput:SWEep[:FREQUENCY]:SPACing</code> .....	1239
<code>[ :SOURce&lt;hw&gt;]:LFOutput:SWEep[:FREQUENCY]:STEP:LOGarithmic</code> .....	1239
<code>[ :SOURce&lt;hw&gt;]:LFOutput:SWEep[:FREQUENCY]:STEP:LINear</code> .....	1239

---

### `[ :SOURce<hw>]:LFOutput:SWEep[:FREQUENCY]:DWELI <Dwell>`

Sets the dwell time for each frequency step of the sweep.

#### Parameters:

<code>&lt;Dwell&gt;</code>	float
	Range: 0.001 to 100
	Increment: 100E-6
	*RST: 0.01
	Default unit: s

**Example:** See [Example "Setup an LF sweep"](#) on page 1227.

**Manual operation:** See ["Dwell Time"](#) on page 529

---

### `[ :SOURce<hw>]:LFOutput:SWEep[:FREQUENCY]:EXECute`

Immediately starts an LF sweep.

`[ :SOURce<hw>]:LFOutput:SWEep[:FREQUENCY]:MODE` determines which sweep is executed, e.g. `SOURce:LFOutput:SWEep:FREQUENCY:MODE STEP`.

**Example:** See [Example "Setup an LF sweep"](#) on page 1227.

**Usage:** Event

**Manual operation:** See ["Execute Single Sweep"](#) on page 530

---

### `[ :SOURce<hw>]:LFOutput:SWEep[:FREQUENCY]:MODE <Mode>`

Sets the cycle mode of the LF sweep.

#### Parameters:

<code>&lt;Mode&gt;</code>	AUTO   MANual   STEP
---------------------------	----------------------

#### **AUTO**

Performs a complete sweep cycle from the start to the end value when a trigger event occurs.

The dwell time determines the time period until the signal switches to the next step.

#### **MANual**

Performs a single sweep step when a manual trigger event occurs.

The trigger system is not active. To trigger each frequency step of the sweep individually, use the command `[ :SOURce<hw>]:LFOutput:FREQUENCY:MANual` on page 1231.

**STEP**

Each trigger command triggers one sweep step only.

The frequency increases by the value set with the commands:

`[ :SOURce<hw> ] :LFOutput :SWEep [ :FREQuency ] :STEP [ :LINear ]` (linear spacing)

`[ :SOURce<hw> ] :LFOutput :SWEep [ :FREQuency ] :STEP :LOGarithmic` (logarithmic spacing)

\*RST: AUTO

**Example:** See [Example "Setup an LF sweep"](#) on page 1227.

**Manual operation:** See ["Mode"](#) on page 528

**[ :SOURce<hw> ] :LFOutput :SWEep [ :FREQuency ] :POINTs <Points>**

Sets the number of steps in an LF sweep.

For information on how the value is calculated and the interdependency with other parameters, see [Section 8.10.2.1, "Correlating parameters in sweep mode"](#), on page 519

**Parameters:**

<Points> integer  
 Range: 2 to POINTs  
 \*RST: 50

**Example:** See [Example "Setup an LF sweep"](#) on page 1227.

**[ :SOURce<hw> ] :LFOutput :SWEep [ :FREQuency ] :RETRace <State>**

Activates that the signal changes to the start frequency value while it is waiting for the next trigger event.

You can enable this feature, when you are working with sawtooth shapes in sweep mode "Single" or "External Single".

**Parameters:**

<State> 1 | ON | 0 | OFF  
 \*RST: 0

**Manual operation:** See ["Retrace"](#) on page 528

**[ :SOURce<hw> ] :LFOutput :SWEep [ :FREQuency ] :RUNNING?**

Queries the current status of the LF frequency sweep mode.

**Return values:**

<State> 1 | ON | 0 | OFF

**Example:** See [Example "Setup an LF sweep"](#) on page 1227.

**Usage:** Query only

---

**[[:SOURce<hw>]:LFOutput:SWEep[:FREQUENCY]:SHAPE <Shape>**

Sets the cycle mode for a sweep sequence (shape).

**Parameters:**

<Shape>                   SAWTooth | TRIangle  
 \*RST:                    SAWTooth

**Example:**                See [Example "Setup an LF sweep"](#) on page 1227.

**Manual operation:**    See ["Shape"](#) on page 528

---

**[[:SOURce<hw>]:LFOutput:SWEep[:FREQUENCY]:SPACING <Spacing>**

Selects linear or logarithmic sweep spacing.

**Parameters:**

<Spacing>                 LINear | LOGarithmic  
 \*RST:                    LINear

**Example:**                See [Example "Setup an LF sweep"](#) on page 1227.

**Manual operation:**    See ["Spacing"](#) on page 529

---

**[[:SOURce<hw>]:LFOutput:SWEep[:FREQUENCY]:STEP:LOGarithmic  
 <Logarithmic>**

Sets the step width factor for logarithmic sweeps to calculate the frequencies of the steps.

For information on how the value is calculated and the interdependency with other parameters, see [Section 8.10.2.1, "Correlating parameters in sweep mode"](#), on page 519

**Parameters:**

<Logarithmic>           float  
                             The unit is mandatory  
                             Range:        0.01 to 100  
                             Increment: 0.01  
                             \*RST:         1  
                             Default unit: PCT

**Example:**                See [Example "Setup an LF sweep"](#) on page 1227.

**Manual operation:**    See ["Step Linear/Step Logarithmic"](#) on page 532

---

**[[:SOURce<hw>]:LFOutput:SWEep[:FREQUENCY]:STEP[:LINear] <Linear>**

Sets the step width for the linear sweep.

For information on how the value is calculated and the interdependency with other parameters, see [Section 8.10.2.1, "Correlating parameters in sweep mode"](#), on page 519

**Parameters:**

<Linear> float  
 Range: 0.1 to STOP-START  
 Increment: 0.1  
 \*RST: 1000

**Example:** See [Example "Setup an LF sweep"](#) on page 1227.

**Manual operation:** See ["Step Linear/Step Logarithmic"](#) on page 532

### 14.19.13 SOURce:LIST subsystem

The SOURce:LIST subsystem contains all commands for defining lists and for handling of list files.

List files have the predefined file extension \*.lsw.

Refer to [Section 14.7.2, "Handling files in the default or in a specified directory"](#), on page 906 for general information on file handling in the default and in a specific directory.



- You can use the same lists for both paths. File operations such as creating, deleting and querying lists are therefore path-independent. In this case, the suffix <HW> under SOURce **must** be omitted. An error message is displayed if the suffix is specified.
- \*RST does not affect data lists.
- SCPI refers to the individual lists as segments.

**Example: Create an RF list and activate the list mode**

The following example shows a command sequence to create an RF list and to activate the list mode. Further hardware settings are not considered.

```
// Reset the instrument to start from an initial state
// Query the available list files in the default
// directory /var/user
// Select the list file or create it (if not existing)
*RST; *CLS
:SOURce1:LIST:CAT?
// Response:- shows the name of available list files (if applicable)
:SOURce1:LIST:SEL "/var/user/list1.lsw"

// Write the frequency/level/dwell time values in the selected list file
// existing data is overwritten
// Query the number of frequency/power/dwell time entries in the selected list
// Query the amount of free memory (in bytes) for list mode lists
:SOURce1:LIST:FREQ 58 MHz, 61 MHz, 73 MHz, 86 MHz, 91 MHz, 92 MHz, 98 MHz
:SOURce1:LIST:POW 13 dBm, 12 dBm, 5 dBm, 3 dBm, 0 dBm, 4 dBm, 6 dBm
:SOURce1:LIST:DWEL:LIST 10000, 100000, 200000, 19000, 10000, 150000, 220000
:SOURce1:LIST:FREQ:POIN?
```



```
// 7
:SOURce1:LIST:POW:POINT?
// 7
:SOURce1:LIST:DWEL:LIST:POIN?
// 7
:SOURce1:LIST:FREE?
// 2147483647 (bytes of free memory)

// Use dwell times from list
// Configure the list mode parameters
// Enable RF output
:SOURce1:LIST:MODE AUTO
:SOURce1:LIST:TRIG:SOUR AUTO
:SOURce1:LIST:DWEL:MODE "LIST"

// Learn list mode data
:SOURce1:LIST:LEAR

:OUTPut1:STAT ON

// Use global dwell time
// Set only a part of the list (value pairs 3 to 5) to be processed
// Configure the list mode parameters using global dwell time
// Learn list mode data
// Enable RF output
:SOURce1:LIST:IND:START 2
:SOURce1:LIST:IND:STOP 4
:SOURce1:LIST:MODE AUTO
:SOURce1:LIST:TRIG:SOUR AUTO
:SOURce1:LIST:DWEL:LIST 500 ms
:SOURce1:LIST:LEAR
:OUTPut1:STAT ON
:SOURce1:LIST:RMODE LEAR

// Enable the list mode
// Trigger the list (depending on the mode, not needed with trigger
// mode AUTO); query the current index
// Reset the list to the starting point
:SOURce1:FREQ:MODE LIST
:SOURce1:LIST:TRIG:EXEC
:SOURce1:LIST:RUNN?
:SOURce1:LIST:IND?
// 3
// value changes when the value is queried again
:SOURce1:LIST:RES

// For list mode STEP use the following commands
*RST; *CLS
// Change list mode to STEP
:SOURce1:LIST:MODE STEP
// Activate RF Output1
```

```

:OUTPut1:STAT 1
// Activate the list mode
:SOURce1:FREQ:MODE LIST
// For each step: select frequency/powerlevel pair as index from the list
:SOURce1:LIST:IND 2
:SOURce1:LIST:IND 3
:SOURce1:LIST:IND 4

// Use the selected list for path B (with List Mode B default settings)
:SOURce2:LIST:SEL "/var/user/list1.lsw"
:OUTPut2:STAT ON
:SOURce2:FREQ:MODE LIST
:SOURce2:LIST:IND?
// 2
// value changes when the value is queried again

// Deactivate the list mode
:SOURce1:FREQ:MODE CW

// Use global dwell time
// Set only a part of the list (value pairs 3 to 5) to be processed
// Configure the list mode parameters using global dwell time
// Enable RF output
:SOURce1:LIST:IND:START 2
:SOURce1:LIST:IND:STOP 4
:SOURce1:LIST:MODE AUTO
:SOURce1:LIST:TRIG:SOUR AUTO
:SOURce1:LIST:DWEL:LIST 500 ms
:OUTPut1:STAT ON

// Enable the list mode
// Trigger the list (depending on the mode, not needed with trigger
// mode AUTO); query the current index
// Reset the list to the starting point
:SOURce1:FREQ:MODE LIST
:SOURce1:LIST:TRIG:EXEC
:SOURce1:LIST:RUNN?
:SOURce1:LIST:IND?
// 3
// value changes when the value is queried again
:SOURce1:LIST:RES

// For list mode STEP use the following commands
*RST; *CLS
// Change list mode to STEP
:SOURce1:LIST:MODE STEP
// Activate RF Output1
:OUTPut1:STAT 1
// Activate the list mode
:SOURce1:FREQ:MODE LIST

```

```

// For each step: select frequency/powerlevel pair as index from the list
:SOURCE1:LIST:IND 2
:SOURCE1:LIST:IND 3
:SOURCE1:LIST:IND 4

// Use the selected list for path B (with List Mode B default settings)
:SOURCE2:LIST:SEL "/var/user/list1.lsw"
:OUTPUT2:STAT ON
:SOURCE2:FREQ:MODE LIST
:SOURCE2:LIST:IND?
// 2
// value changes when the value is queried again

// Deactivate the list mode
:SOURCE1:FREQ:MODE CW

```

### Example: List mode data exchange

The following example shows a command sequence to export a list (here the RF list created with the example before) into an ASCII file. Further hardware settings are not considered.

```

*RST; *CLS
LIST:DEXC:MODE EXP

// Set ASCII data parameters
// Set the ASCII file extension, the decimal separator
// and the column separator for the ASCII data
:SOURCE1:LIST:DEXC:AFIL:EXT CSV
:SOURCE1:LIST:DEXC:AFIL:SEP:DEC DOT
:SOURCE1:LIST:DEXC:AFIL:SEP:COL COMM

// Select source and destination path/directory
// Query available listfiles in default directory "/var/user"
:SOURCE1:LIST:CAT?
// list1
:SOURCE1:LIST:DEXC:AFIL:SEL "/var/user/list1ASCII"
:SOURCE1:LIST:DEXC:SEL "/var/user/list1"

// Export the list file data into the ASCII file
:SOURCE1:LIST:DEXC:EXEC

// Query the available ASCII files with extension .csv
:SOURCE1:LIST:DEXC:AFIL:CAT?
// Response: "list1ASCII"

// Deactivate the list mode
:SOURCE1:FREQ:MODE CW

```

- [List mode settings](#)..... 1244
- [List mode file operation](#)..... 1250
- [List mode data exchange](#)..... 1252

#### 14.19.13.1 List mode settings

With the following commands, you can create list mode data, select the trigger mode and determine the dwell time.

<a href="#">[:SOURce&lt;hw&gt;]:LIST:DWELL</a> .....	1244
<a href="#">[:SOURce&lt;hw&gt;]:LIST:DWELL:MODE</a> .....	1244
<a href="#">[:SOURce&lt;hw&gt;]:LIST:DWELL:LIST</a> .....	1245
<a href="#">[:SOURce&lt;hw&gt;]:LIST:DWELL:LIST:POINts?</a> .....	1245
<a href="#">[:SOURce&lt;hw&gt;]:LIST:FREQUency</a> .....	1245
<a href="#">[:SOURce&lt;hw&gt;]:LIST:FREQUency:POINts?</a> .....	1246
<a href="#">[:SOURce&lt;hw&gt;]:LIST:INDex</a> .....	1246
<a href="#">[:SOURce&lt;hw&gt;]:LIST:INDex:START</a> .....	1246
<a href="#">[:SOURce&lt;hw&gt;]:LIST:INDex:STOP</a> .....	1246
<a href="#">[:SOURce&lt;hw&gt;]:LIST:RMODE</a> .....	1247
<a href="#">[:SOURce&lt;hw&gt;]:LIST:LEARN</a> .....	1247
<a href="#">[:SOURce&lt;hw&gt;]:LIST:MODE</a> .....	1247
<a href="#">[:SOURce&lt;hw&gt;]:LIST:POWER</a> .....	1248
<a href="#">[:SOURce&lt;hw&gt;]:LIST:POWER:POINts?</a> .....	1248
<a href="#">[:SOURce&lt;hw&gt;]:LIST:TRIGger:EXECute</a> .....	1249
<a href="#">[:SOURce&lt;hw&gt;]:LIST:TRIGger:SOURce</a> .....	1249
<a href="#">[:SOURce&lt;hw&gt;]:LIST:RUNNing?</a> .....	1250

---

#### **[:SOURce<hw>]:LIST:DWELL <Dwell>**

Sets the global dwell time. The instrument generates the signal with the frequency / power value pairs of each list entry for that particular period.

See also [Significant parameters and functions](#).

#### **Parameters:**

<Dwell>	float
	Range: 0.5E-3 to 100
	Increment: 1E-6
	*RST: 0.01

**Example:** See [Example "Create an RF list and activate the list mode"](#) on page 1240.

**Manual operation:** See ["Global Dwell Time"](#) on page 537

---

#### **[:SOURce<hw>]:LIST:DWELL:MODE <DwellMode>**

Selects the dwell time mode.

#### **Parameters:**

<DwellMode>	LIST   GLOBal
-------------	---------------

**LIST**

Uses the dwell time, specified in the data table for each value pair individually.

**GLOBAL**

Uses a constant dwell time, set with command [ :  
SOURce<hw> ] :LIST:DWELL.

\*RST: GLOBAL

**Example:** See [Example "Create an RF list and activate the list mode"](#) on page 1240.

**Manual operation:** See ["Dwell Time Mode"](#) on page 537

**[ :SOURce<hw> ] :LIST:DWELL:LIST <Dwell>**

Enters the dwell time values in the selected list in  $\mu$ s.

**Parameters:**

<Dwell> <Dwell#1>{, <Dwell#2>, ...} | block data

You can either enter the data as a list of numbers, or as binary block data. The list of numbers can be of any length, with the list entries separated by commas.

In binary block format, 8 (4) bytes are always interpreted as a floating-point number with double accuracy. See also :  
FORMat [ :DATA ] on page 938 for more details.

**Example:** See [Example "Create an RF list and activate the list mode"](#) on page 1240.

**Manual operation:** See ["Dwell Time \(s\)"](#) on page 543

**[ :SOURce<hw> ] :LIST:DWELL:LIST:POINTS?**

Queries the number (points) of dwell time entries in the selected list.

**Return values:**

<Points> integer  
Range: 0 to INT\_MAX  
\*RST: 0

**Example:** See [Example "Create an RF list and activate the list mode"](#) on page 1240.

**Usage:** Query only

**[ :SOURce<hw> ] :LIST:FREQUENCY <Frequency>**

Enters the frequency values in the selected list.

**Parameters:**

<Frequency> <Frequency#1>{, <Frequency#2>, ...} | block data

You can either enter the data as a list of numbers, or as binary block data.

The list of numbers can be of any length, with the list entries separated by commas.

In binary block format, 8 (4) bytes are always interpreted as a floating-point number with double accuracy.

See also :FORMat [ :DATA] .

Range: 300 kHz to RFmax (depends on the installed options)

**Example:** See [Example "Create an RF list and activate the list mode"](#) on page 1240.

**Manual operation:** See "[Frequency \(Hz\)](#)" on page 543

### **[ :SOURce<hw>]:LIST:FREQuency:POINts?**

Queries the number (points) of frequency entries in the selected list.

#### **Return values:**

<Points> integer  
 Range: 0 to INT\_MAX  
 \*RST: 0

**Example:** See [Example "Create an RF list and activate the list mode"](#) on page 1240.

**Usage:** Query only

### **[ :SOURce<hw>]:LIST:INDex <Index>**

Sets the list index in [LIST:MODE STEP](#).

After the trigger signal, the instrument processes the frequency and level settings of the selected index.

#### **Parameters:**

<Index> integer  
 \*RST: 0

**Example:** See [Example "Create an RF list and activate the list mode"](#) on page 1240.

**Manual operation:** See "[Current Index](#)" on page 536

### **[ :SOURce<hw>]:LIST:INDex:STARt <Start>**

### **[ :SOURce<hw>]:LIST:INDex:STOP <Stop>**

Sets the start and stop index of the index range which defines a subgroup of frequency/level value pairs in the current list.

**Parameters:**

<Stop> integer  
 Index range  
 Only values inside this range are processed in list mode  
 Range: 0 to list length  
 \*RST: 0

**Example:** See [Example "Create an RF list and activate the list mode"](#) on page 1240.

**Manual operation:** See ["List Range from/to"](#) on page 539

**[:SOURce<hw>]:LIST:RMODE <RMode>**

Selects the run mode for processing the list.

**Parameters:**

<RMode> LEARNed | LIVE  
**LEARned**  
 Generates the signal by replaying the previously learned and saved data from the temporary memory.  
**LIVE**  
 Generates the signal by processing the list directly.  
 \*RST: LIVE

**Example:** See [Example "Create an RF list and activate the list mode"](#) on page 1240.

**Manual operation:** See ["Run Mode"](#) on page 537

**[:SOURce<hw>]:LIST:LEARN**

Learns the selected list to determine the hardware setting for all list entries. The results are saved with the list.

See also ["Learn List Mode Data list processing mode"](#) on page 524.

**Example:** See [Example "Create an RF list and activate the list mode"](#) on page 1240.

**Usage:** Event

**Manual operation:** See ["Learn List Mode Data"](#) on page 538

**[:SOURce<hw>]:LIST:MODE <Mode>**

Sets the list mode.

The instrument processes the list according to the selected mode and trigger source. See [LIST:TRIG:SOUR AUTO](#), [SING](#) or [EXT](#) for the description of the trigger source settings.

**Parameters:**

<Mode> AUTO | STEP

**AUTO**

Each trigger event triggers a complete list cycle.

**STEP**

Each trigger event triggers only one step in the list processing cycle. The list is processed in ascending order.

**INDEX**

The trigger event triggers the entry of the selected index in the list.

\*RST: AUTO

**Example:**

See [Example "Create an RF list and activate the list mode"](#) on page 1240.

**Manual operation:** See ["Mode"](#) on page 536

**[ :SOURce<hw> ]:LIST:POWER <Power>**

Enters the level values in the selected list. The number of level values must correspond to the number of frequency values. Existing data is overwritten.

**Parameters:**

<Power> <Power#1>{, <Power#2>, ...} | block data

You can either enter the data as a list of numbers, or as binary block data.

The list of numbers can be of any length, with the list entries separated by commas.

In binary block format, 8 (4) bytes are always interpreted as a floating-point number with double accuracy.

See also [:FORMat \[ :DATA \]](#).

Range: depends on the installed options

Default unit: dBm

**Example:**

See [Example "Create an RF list and activate the list mode"](#) on page 1240.

**Manual operation:** See ["Power \(dBm\)"](#) on page 543

**[ :SOURce<hw> ]:LIST:POWER:POINTS?**

Queries the number (points) of level entries in the selected list.

**Return values:**

<Points> integer

Range: 0 to INT\_MAX

\*RST: 0



**Example:** See [Example "Create an RF list and activate the list mode"](#) on page 1240.

**Usage:** Query only

#### **[ :SOURce<hw> ] :LIST:TRIGger:EXECute**

Starts the processing of a list in list mode.

**Example:** See [Example "Create an RF list and activate the list mode"](#) on page 1240.

**Usage:** Event

**Manual operation:** See ["Execute Single"](#) on page 538

#### **[ :SOURce<hw> ] :LIST:TRIGger:SOURce <Source>**

Selects the trigger source for processing lists.

The designation of the parameters correspond to those in sweep mode. SCPI standard uses other designations for the parameters, which are also accepted by the instrument. The SCPI designation should be used if compatibility is an important consideration. For an overview, see the following table:

Rohde & Schwarz parameter	SCPI parameter	Applies to the list mode parameters:
AUTO	IMMediate	[ :SOURce<hw> ] :LIST:MODE AUTO
SINGle	BUS	[ :SOURce<hw> ] :LIST:MODE AUTO or [ :SOURce<hw> ] :LIST:MODE STEP
EXTernal	EXTernal	[ :SOURce<hw> ] :LIST:MODE AUTO or [ :SOURce<hw> ] :LIST:MODE STEP

#### **Parameters:**

<Source>

AUTO | IMMediate | SINGle | BUS | EXTernal

#### **AUTO|IMMediate**

The trigger is free-running, i.e. the trigger condition is fulfilled continuously. The selected list is restarted as soon as it is finished.

#### **SINGle|BUS**

The list is triggered by the command [ :SOURce<hw> ] :LIST:TRIGger:EXECute. The list is executed once.

#### **EXTernal**

The list is triggered externally and executed once.

\*RST: AUTO

**Example:** See [Example "Create an RF list and activate the list mode"](#) on page 1240.

**Manual operation:** See ["Mode"](#) on page 536

---

**[ :SOURce<hw>]:LIST:RUNNING?**

Queries the current state of the list mode.

**Return values:**

<State>                    1 | ON | 0 | OFF  
                              **1**

Signal generation based on the list mode is active.

**Example:**                See [Example "Create an RF list and activate the list mode"](#) on page 1240.

**Usage:**                    Query only

### 14.19.13.2 List mode file operation

The following section covers basic commands to file handling in list mode.

<a href="#">[:SOURce&lt;hw&gt;]:LIST:CATalog?</a> .....	1250
<a href="#">[:SOURce&lt;hw&gt;]:LIST:DELeTe</a> .....	1250
<a href="#">[:SOURce&lt;hw&gt;]:LIST:DELeTe:ALL</a> .....	1251
<a href="#">[:SOURce&lt;hw&gt;]:LIST:FREE?</a> .....	1251
<a href="#">[:SOURce&lt;hw&gt;]:LIST:RESet</a> .....	1251
<a href="#">[:SOURce&lt;hw&gt;]:LIST:SElect</a> .....	1252

---

**[ :SOURce<hw>]:LIST:CATalog?**

Queries the available list files in the specified directory.

**Return values:**

<Catalog>                string  
                              List of list filenames, separated by commas

**Example:**                See [Example "Create an RF list and activate the list mode"](#) on page 1240.

**Usage:**                    Query only

**Manual operation:**    See "[List Mode Data](#)" on page 539

---

**[ :SOURce<hw>]:LIST:DELeTe <Filename>**

Deletes the specified list.

**Setting parameters:**

<Filename>                string  
                              Filename or complete file path; file extension is optional.

**Example:**                See [\[:SOURce<hw>\]:LIST:DELeTe:ALL](#) on page 1251.

**Usage:**                    Setting only

**Manual operation:**    See "[List Mode Data](#)" on page 539

**[[:SOURce<hw>]:LIST:DELeTe:ALL**

Deletes all lists in the set directory.

This command can only be executed, if:

- No list file is selected.
- List mode is disabled.

**Example:**

```
SOUR1:LIST:CAT?
// list,my_list
SOUR1:LIST:DEL "/var/user/list1"
SOUR1:LIST:CAT?
// my_list
SOUR1:FREQ:MODE?
// LIST
SOUR1:LIST:SEL?
// /var/user/my_list.lsw
//deactivate list mode
SOUR1:FREQ:MODE CW
SOUR1:LIST:DELeTe:ALL
SOUR1:LIST:CAT?
// -
// all list files are deleted
```

**Usage:** Event

**Manual operation:** See "[List Mode Data](#)" on page 539

**[[:SOURce<hw>]:LIST:FREE?**

Queries the amount of free memory (in bytes) for list mode lists.

**Return values:**

```
<Free> integer
Range: 0 to INT_MAX
*RST: 0
```

**Example:** See [Example "Create an RF list and activate the list mode"](#) on page 1240.

**Usage:** Query only

**[[:SOURce<hw>]:LIST:RESet**

Jumps to the beginning of the list.

**Example:** See [Example "Create an RF list and activate the list mode"](#) on page 1240.

**Usage:** Event

**Manual operation:** See "[Reset](#)" on page 538

**[:SOURce<hw>]:LIST:SElect <Filename>**

Selects or creates a data list in list mode.

If the list with the selected name does not exist, a new list is created.

**Parameters:**

<Filename> string  
Filename or complete file path; file extension can be omitted.

**Example:** See [Example "Create an RF list and activate the list mode"](#) on page 1240.

**Manual operation:** See ["List Mode Data"](#) on page 539

**14.19.13.3 List mode data exchange**

With the following commands, you can configure lists in ASCII format and export or import them accordingly.

<a href="#">[:SOURce&lt;hw&gt;]:LIST:DEXChange:AFILe:CATalog?</a> .....	1252
<a href="#">[:SOURce&lt;hw&gt;]:LIST:DEXChange:AFILe:EXTension</a> .....	1252
<a href="#">[:SOURce&lt;hw&gt;]:LIST:DEXChange:AFILe:SElect</a> .....	1253
<a href="#">[:SOURce&lt;hw&gt;]:LIST:DEXChange:AFILe:SEParator:COLumn</a> .....	1253
<a href="#">[:SOURce&lt;hw&gt;]:LIST:DEXChange:AFILe:SEParator:DECimal</a> .....	1253
<a href="#">[:SOURce&lt;hw&gt;]:LIST:DEXChange:EXECute</a> .....	1253
<a href="#">[:SOURce&lt;hw&gt;]:LIST:DEXChange:MODE</a> .....	1254
<a href="#">[:SOURce&lt;hw&gt;]:LIST:DEXChange:SElect</a> .....	1254

**[:SOURce<hw>]:LIST:DEXChange:AFILe:CATalog?**

Queries the available ASCII files for export or import of list mode data in the current or specified directory.

**Return values:**

<Catalog> string  
List of ASCII files \*.txt or \*.csv, separated by commas.

**Example:** See [Example "List mode data exchange"](#) on page 1243.

**Usage:** Query only

**Manual operation:** See ["Select \(ASCII\) Source/Select \(ASCII\) Destination"](#) on page 541

**[:SOURce<hw>]:LIST:DEXChange:AFILe:EXTension <Extension>**

Determines the extension of the ASCII file for import or export, or to query existing files.

**Parameters:**

<Extension> TXT | CSV  
\*RST: TXT

**Example:** See [Example "List mode data exchange"](#) on page 1243.

**Manual operation:** See ["ASCII File Settings"](#) on page 541

**[ :SOURce<hw> ]:LIST:DEXChange:AFILe:SElect <Filename>**

Selects the ASCII file to be imported or exported.

**Parameters:**

<Filename> string  
Filename or complete file path; file extension can be omitted.

**Example:** See [Example "List mode data exchange"](#) on page 1243.

**Manual operation:** See ["Select \(ASCII\) Source/Select \(ASCII\) Destination"](#) on page 541

**[ :SOURce<hw> ]:LIST:DEXChange:AFILe:SEParator:COLumn <Column>**

Selects the separator between the frequency and level column of the ASCII table.

**Parameters:**

<Column> TABulator | SEMicolon | COMMa | SPACe  
\*RST: COMMa

**Example:** See [Example "List mode data exchange"](#) on page 1243.

**Manual operation:** See ["ASCII File Settings"](#) on page 541

**[ :SOURce<hw> ]:LIST:DEXChange:AFILe:SEParator:DECimal <Decimal>**

Sets "." (decimal point) or "," (comma) as the decimal separator used in the ASCII data with floating-point numerals.

**Parameters:**

<Decimal> DOT | COMMa  
\*RST: DOT

**Example:** See [Example "List mode data exchange"](#) on page 1243.

**Manual operation:** See ["ASCII File Settings"](#) on page 541

**[ :SOURce<hw> ]:LIST:DEXChange:EXECute**

Executes the import or export of the selected list file, according to the previously set transfer direction with command `[ :SOURce<hw> ] :LIST:DEXChange:MODE`

**Example:** See [Example "List mode data exchange"](#) on page 1243.

**Usage:** Event

**Manual operation:** See ["Import / Export"](#) on page 541

**[ :SOURce<hw>]:LIST:DEXChange:MODE <Mode>**

Determines the import or export of a list.

Specify the source or destination file with the command `[ :SOURce<hw>]:LIST:DEXChange:SElect`.

**Parameters:**

<Mode>                   IMPort | EXPort  
\*RST:                   IMPort

**Example:**               See [Example "List mode data exchange"](#) on page 1243.

**Manual operation:**   See ["Mode"](#) on page 540

**[ :SOURce<hw>]:LIST:DEXChange:SElect <Filename>**

Selects the ASCII file for import or export, containing a list.

**Parameters:**

<Filename>               string  
                              Filename or complete file path; file extension can be omitted.

**Example:**               See [Example "List mode data exchange"](#) on page 1243.

**Manual operation:**   See ["Select Source/Select ASCII Destination"](#) on page 541

### 14.19.14 SOURce:NOISe subsystem

The SOURce:NOISe subsystem contains the commands for:

- Setting the noise modulation signal. The noise generator is optional.
- Generating impulsive and phase noise.  
R&S SMW-K810

**Example: Configuring the noise generator**

```
SOURce1:NOISe:DIStributioN GAUSS
SOURce1:NOISe:BANdwidth 10000000

SOURce1:LFOutput1:SOURce NOIS
SOURce1:LFOutput1:STATe 1

SOURce1:NOISe:LEVel1:RELative?
SOURce1:NOISe:LEVel1:ABSolute?
```

**Example: Generating impulsive noise**

```

SOURce1:NOISE:IMPulsive:CI 20
SOURce1:NOISE:IMPulsive:FRAMe 0.01
SOURce1:NOISE:IMPulsive:PULSe 5
SOURce1:NOISE:IMPulsive:MINSpace 0.00000025
SOURce1:NOISE:IMPulsive:MAXSpace 0.0000005
SOURce1:NOISE:IMPulsive:BURSt:DURation?
// 0.00000125
SOURce1:NOISE:IMPulsive:STATe 1

```

**Example: Generating phase noise**

```

SOURce1:NOISE:PHASnoise:FREQuency1 100
SOURce1:NOISE:PHASnoise:LEVel1 -40
SOURce1:NOISE:PHASnoise:FREQuency2 1000
SOURce1:NOISE:PHASnoise:LEVel2 -30
SOURce1:NOISE:PHASnoise:FREQuency3 10000
SOURce1:NOISE:PHASnoise:LEVel3 -60
SOURce1:NOISE:PHASnoise:FREQuency4 100000
SOURce1:NOISE:PHASnoise:LEVel4 -50
SOURce1:NOISE:PHASnoise:FREQuency5 1000000
SOURce1:NOISE:PHASnoise:LEVel5 -80
SOURce1:NOISE:PHASnoise:STATe 1

SOURce1:NOISE:PHASnoise:SHAPE:STORe "/var/user/phasenoise.fcf"
SOURce1:NOISE:PHASnoise:SHAPE:PREDefined:CATalog?
// ATSC_A74,crystal1,crystal2,crystal3,crystal4,crystal5,DVB-S2 A1,DVB-S2 A2,DVB-S2 D1,DVB-S2
// DVB-S2 P2,p111,p112
SOURce1:NOISE:PHASnoise:SHAPE:SElect "crystal1"

```

- [Noise generator](#).....1255
- [Impulsive noise commands](#).....1256
- [Phase noise commands](#).....1258

**14.19.14.1 Noise generator**

```

[:SOURce<hw>]:NOISE:BANDwidth|BWIDTH.....1255
[:SOURce<hw>]:NOISE:DISTRibution.....1256
[:SOURce<hw>]:NOISE:LEVel<ch>:RELative?.....1256
[:SOURce<hw>]:NOISE:LEVel<ch>[:ABSolute]?.....1256

```

---

**[:SOURce<hw>]:NOISE:BANDwidth|BWIDTH <BWidth>**

Sets the noise level in the system bandwidth when bandwidth limitation is enabled.

**Parameters:**

<BWidth>	float
Range:	100E3 to 10E6
Increment:	100E3
*RST:	100E3

**Example:** See [Example "Configuring the noise generator"](#) on page 1254.

**Manual operation:** See ["Bandwidth"](#) on page 575

#### **[[:SOURce<hw>]:NOISe:DISTRibution <Distribution>**

Sets the distribution of the noise power density.

**Parameters:**

<Distribution> GAUSs | EQUal  
\*RST: GAUSs

**Example:** See [Example "Configuring the noise generator"](#) on page 1254.

**Manual operation:** See ["Distribution"](#) on page 575

#### **[[:SOURce<hw>]:NOISe:LEVel<ch>:RELative?**

Queries the level of the noise signal per Hz in the total bandwidth.

**Return values:**

<Relative> float  
Range: -149.18 to -52.67  
Increment: 0.1  
\*RST: -69.84

**Example:** See [Example "Configuring the noise generator"](#) on page 1254.

**Usage:** Query only

**Manual operation:** See ["Noise Density"](#) on page 577

#### **[[:SOURce<hw>]:NOISe:LEVel<ch>[:ABSolute]?**

Queries the level of the noise signal in the system bandwidth within the enabled bandwidth limitation.

**Return values:**

<Absolute> float  
\*RST: 3.84 MHz

**Example:** See [Example "Configuring the noise generator"](#) on page 1254.

**Usage:** Query only

**Manual operation:** See ["Noise Level"](#) on page 577

### **14.19.14.2 Impulsive noise commands**

Option: R&S SMW-K810.

<a href="#">[:SOURce&lt;hw&gt;]:NOISe:IMPulsive[:STATE]</a> .....	1257
<a href="#">[:SOURce&lt;hw&gt;]:NOISe:IMPulsive:CI</a> .....	1257
<a href="#">[:SOURce&lt;hw&gt;]:NOISe:IMPulsive:FRAME</a> .....	1257



<a href="#">[:SOURce&lt;hw&gt;]:NOISE:IMPulsive:PULSe.....</a>	1257
<a href="#">[:SOURce&lt;hw&gt;]:NOISE:IMPulsive:MINSpace.....</a>	1258
<a href="#">[:SOURce&lt;hw&gt;]:NOISE:IMPulsive:MAXSpace.....</a>	1258
<a href="#">[:SOURce&lt;hw&gt;]:NOISE:IMPulsive[:BURSt]:DURation?.....</a>	1258

---

### **[:SOURce<hw>]:NOISE:IMPulsive[:STATe] <ImpulsiveState>**

Enables or disables the impulsive noise generator.

#### **Parameters:**

<ImpulsiveState>    1 | ON | 0 | OFF  
                           \*RST:        0

**Example:**            See [Example "Generating impulsive noise"](#) on page 1255.

**Manual operation:** See ["State"](#) on page 445

---

### **[:SOURce<hw>]:NOISE:IMPulsive:CI <IplsCI>**

Specifies the ratio of the wanted signal (C) to the impulsive noise signal (I).

#### **Parameters:**

<IplsCI>                float  
                           Range:        -35 to 60  
                           Increment:   0.01  
                           \*RST:        20

**Example:**            See [Example "Generating impulsive noise"](#) on page 1255.

**Manual operation:** See ["C/I"](#) on page 445

---

### **[:SOURce<hw>]:NOISE:IMPulsive:FRAME <IplsFrameDur>**

Sets the time intervals at which the bursts occur.

#### **Parameters:**

<IplsFrameDur>        float  
                           Range:        0.1E-3 to 1  
                           Increment:   0.1E-3  
                           \*RST:        0.01

**Example:**            See [Example "Generating impulsive noise"](#) on page 1255.

**Manual operation:** See ["Frame Duration"](#) on page 446

---

### **[:SOURce<hw>]:NOISE:IMPulsive:PULSe <IplsPulse>**

Sets the number of noise pulses per burst.

#### **Parameters:**

<IplsPulse>            integer  
                           Range:        1 to 65535  
                           \*RST:        1

**Example:** See [Example "Generating impulsive noise"](#) on page 1255.

**Manual operation:** See ["Pulses per Burst"](#) on page 446

**[ :SOURce<hw>]:NOISe:IMPulsive:MINSpace <lplsMinSpace>**  
**[ :SOURce<hw>]:NOISe:IMPulsive:MAXSpace <lplsSpaceMax>**

If more than 1 pulse per burst are enabled (`[ :SOURce<hw>]:NOISe:IMPulsive:PULSe.g. 2`), sets the minimum/maximum spacing between 2 pulses within a burst.

**Parameters:**

<lplsSpaceMax> float  
 Range: 0.25E-6 to 0.01  
 Increment: 0.01E-6  
 \*RST: 0.25E-6

**Example:** See [Example "Generating impulsive noise"](#) on page 1255.

**Manual operation:** See ["Pulse Spacing Maximum"](#) on page 446

**[ :SOURce<hw>]:NOISe:IMPulsive[:BURSt]:DURation?**

Queries the time during which the noise generator is active in a frame.

**Return values:**

<lplsBurstDur> float  
 Range: 0.01E-6 to 1  
 Increment: 0.01E-6  
 \*RST: n.a. (no preset. default: 0.01)

**Example:** See [Example "Generating impulsive noise"](#) on page 1255.

**Usage:** Query only

**Manual operation:** See ["Eff. Burst Duration"](#) on page 446

### 14.19.14.3 Phase noise commands

Option: R&S SMW-K810.

<a href="#">[:SOURce&lt;hw&gt;]:NOISe:PHASenoiSe[:STATe]</a> .....	1258
<a href="#">[:SOURce&lt;hw&gt;]:NOISe:PHASenoiSe:SHAPE:PREDeFined:CATalog?</a> .....	1259
<a href="#">[:SOURce&lt;hw&gt;]:NOISe:PHASenoiSe:SHAPE:SELEct</a> .....	1259
<a href="#">[:SOURce&lt;hw&gt;]:NOISe:PHASenoiSe:SHAPE:STORe</a> .....	1259
<a href="#">[:SOURce&lt;hw&gt;]:NOISe:PHASenoiSe:LEVel&lt;ch&gt;</a> .....	1259
<a href="#">[:SOURce&lt;hw&gt;]:NOISe:PHASenoiSe:FREQUency&lt;ch&gt;</a> .....	1260

**[ :SOURce<hw>]:NOISe:PHASenoiSe[:STATe] <PhaseNoiseState>**

Enables or disables the phase noise generator.

**Parameters:**

<PhaseNoiseState> 1 | ON | 0 | OFF  
 \*RST: 0

**Example:** See [Example "Generating phase noise"](#) on page 1255.

**Manual operation:** See ["State"](#) on page 448

**[ :SOURce<hw> ] :NOISe:PHASenoiSe:SHAPE:PREDeFined:CATalog?**

Queries the files with predefined settings. Listed are files with the file extension \*.fcf.

**Example:** See [Example "Generating phase noise"](#) on page 1255.

**Usage:** Query only

**Manual operation:** See ["Load Profile, Save Profile"](#) on page 448

**[ :SOURce<hw> ] :NOISe:PHASenoiSe:SHAPE:SELEct <PhaseNoiseSel>**

Loads the selected file from the default or the specified directory. Loaded are files with extension \*.fcf.

Query the name of the predefined files with the command `[ :SOURce<hw> ] :NOISe:PHASenoiSe:SHAPE:PREDeFined:CATalog?` on page 1259.

**Parameters:**

<PhaseNoiseSel> "<filename>"  
 Filename or complete file path; file extension can be omitted

**Example:** See [Example "Generating phase noise"](#) on page 1255.

**Manual operation:** See ["Load Profile, Save Profile"](#) on page 448

**[ :SOURce<hw> ] :NOISe:PHASenoiSe:SHAPE:STORE <PhaseNoiseStore>**

Saves the current SSB profile settings into the selected file; the file extension (\*.fcf) is assigned automatically.

**Parameters:**

<PhaseNoiseStore> "<filename>"  
 Filename or complete file path

**Example:** See [Example "Generating phase noise"](#) on page 1255.

**Manual operation:** See ["Load Profile, Save Profile"](#) on page 448

**[ :SOURce<hw> ] :NOISe:PHASenoiSe:LEVEl<ch> <PhaseNoiseLevel>**

Sets the level value of the points, where the points are designated by the suffix <ch>.

**Suffix:**

<ch> 1 to 5  
Defines the frequency/noise point number

**Parameters:**

<PhaseNoiseLevel> float  
Range: -199.99 to 0  
Increment: 0.01  
\*RST: 0

**Example:** See [Example "Generating phase noise"](#) on page 1255.

**Manual operation:** See ["Phase Noise Table"](#) on page 449

**[[:SOURce<hw>]:NOISe:PHASenoise:FREQuency<ch> <PhaseNoiseFreq>**

Sets the frequency value of the points, where the points are designated by the suffix <ch>.

**Suffix:**

<ch> 1 to 5  
Defines the frequency/noise point number

**Parameters:**

<PhaseNoiseFreq> integer  
Range: 10 to 10E6  
\*RST: 0

**Example:** See [Example "Generating phase noise"](#) on page 1255.

**Manual operation:** See ["Phase Noise Table"](#) on page 449

### 14.19.15 SOURce:OCCupy subsystem

The OCCupy subsystem contains the commands for selecting licenses and setting the occupation period.

**Example: Occupying a license and extend the occupation period**

```
// query options available on the connected license servers
[:SOURce]:OCCupy:OPTion:CATalog?

// query the number of occupied options and the time periods
[:SOURce]:OCCupy:OPTion:CATalog?
//Response:
"SMW-K55;LTE Release 8;6d, 3d
SMW-K62;Additive White Gaussian Noise;7d, 23h
SMW-K71;Dynamic Fading;4d
SMW-K72;Enhanced Fading Models"

// query the number of occupied licences for option K55
[:SOURce]:OCCupy:OPTion:CATalog? "SMW-K55"
```

```
// Response:
"SMW-K55;LTE Release 8;6d, 3d"

// occupy two licenses of option K55 for 3 days
[:SOURce]:OCCupy:OPTion "R&S SMW-K55",3,2

// extend the occupation period for the first license to 5 days
[:SOURce]:OCCupy:OPTion:RENew<1> "R&S SMW-K55",5
```

**Commands:**

<a href="#">[:SOURce]:OCCupy:OPTion</a> .....	1261
<a href="#">[:SOURce]:OCCupy:OPTion:CATalog?</a> .....	1261
<a href="#">[:SOURce]:OCCupy:OPTion:RENew&lt;ch&gt;</a> .....	1261

**[[:SOURce]:OCCupy:OPTion**

Occupies the selected option.

You can determine the option string, the time period and the number of licenses for the occupancy.

**Example:** See [Example "Occupying a license and extend the occupation period"](#) on page 1260.

**Usage:** Event

**Manual operation:** See ["Occupy"](#) on page 779

**[[:SOURce]:OCCupy:OPTion:CATalog?**

Queries the availability of borrowable licenses on all license servers accessible for the R&S SMW200A.

**Return values:**

<OccLicensesCat> string  
Comma-separated list of strings for available options.

**Example:** See [Example "Occupying a license and extend the occupation period"](#) on page 1260.

**Usage:** Query only

**Manual operation:** See ["Occupy Licenses"](#) on page 778

**[[:SOURce]:OCCupy:OPTion:RENew<ch>**

Extends the occupation period of the selected license.

**Example:** See [Example "Occupying a license and extend the occupation period"](#) on page 1260.

**Usage:** Event

**Manual operation:** See ["Renew"](#) on page 779

### 14.19.16 SOURce:PGEN subsystem

The PGEN subsystem contains the commands for setting output of the pulse modulation signal.

#### Example: Using pulse generator as source for pulse modulation

```
// select pulse generator as source for pulse modulation
// enable pulse modulation
SOURce1:PULM:SOURce INT
SOURce1:PULM:STATE 1
// pulse generator and signal output are also activated
SOURce1:PGENerator:STATE?
// 1
SOURce1:PGENerator:OUTPut:STATE?
// 1
PGENerator:OUTPut:POLarity NORMal
// to disable pulse generator
SOURce1:PGENerator:STATE 0
// activate the pulse modulation of the RF carrier
SOURce1:PULM:STATE 1
```

#### Example: Assigning the pulse input and pulse output signal to the default global user connectors

```
// preset the user connectors 4, 5 and 6
:SOURce<hw>:PGENerator:SET:GLB:CONNectors
```

```
:SOURce<hw>:PGENerator:SET:GLB:CONNectors..... 1262
[:SOURce<hw>]:PGENerator:OUTPut:POLarity..... 1263
[:SOURce<hw>]:PGENerator:OUTPut[:STATE]..... 1263
[:SOURce<hw>]:PGENerator:STATE..... 1263
```

---

#### :SOURce<hw>:PGENerator:SET:GLB:CONNectors

Routes the pulse input signal and the pulse output signal to a global connector.

By default, routes the pulse input to "USER 4" ("Signal" > "Pulse In") and the pulse output to "USER 5" ("Signal" > "Pulse Out").

**Example:** See [Example "Assigning the pulse input and pulse output signal to the default global user connectors"](#) on page 1262.

**Usage:** Event

**Manual operation:** See ["Set Global Connectors for Pulse Modulation"](#) on page 568

---

**[:SOURce<hw>]:PGENERator:OUTPut:POLarity <Polarity>**

Sets the polarity of the pulse output signal.

**Parameters:**

<Polarity>            NORMal | INVerted

**NORMal**

Outputs the pulse signal during the pulse width, that means during the high state.

**INVerted**

Inverts the pulse output signal polarity. The pulse output signal is suppressed during the pulse width, but provided during the low state.

\*RST:            NORMal

**Example:**            See [Example "Using pulse generator as source for pulse modulation"](#) on page 1262.

**Manual operation:**    See ["Pulse Output Polarity"](#) on page 568

---

**[:SOURce<hw>]:PGENERator:OUTPut[:STATe] <State>**

Activates the output of the pulse modulation signal.

**Parameters:**

<State>            1 | ON | 0 | OFF

\*RST:            0

**Example:**            See [Example "Using pulse generator as source for pulse modulation"](#) on page 1262.

**Manual operation:**    See ["Pulse Output State"](#) on page 568

---

**[:SOURce<hw>]:PGENERator:STATe <State>**

Enables the output of the video/sync signal.

If the pulse generator is the current modulation source, activating the pulse modulation automatically activates the signal output and the pulse generator.

**Parameters:**

<State>            1 | ON | 0 | OFF

\*RST:            0

**Example:**            See [Example "Using pulse generator as source for pulse modulation"](#) on page 1262.

### 14.19.17 SOURce:PHASe subsystem

This subsystem contains the commands for adjusting the phase of the RF output signal relative to a reference signal of the same frequency.

**Example: Programming Example**

```
// change the phase relative to the current phase
SOURce1:PHASe 2 DEG
// adopt the setting as the current phase
SOURce1:PHASe:REFerence
```

The following commands are available:

<a href="#">[:SOURce&lt;hw&gt;]:PHASe</a> .....	1264
<a href="#">[:SOURce&lt;hw&gt;]:PHASe:REFerence</a> .....	1264

**[:SOURce<hw>]:PHASe <Phase>**

Sets the phase variation relative to the current phase.

**Parameters:**

<Phase>	float
Range:	-720 to 720
Increment:	0.1
*RST:	0
Default unit:	DEG

**Example:** See [Example "Programming Example"](#) on page 1264.

**Manual operation:** See ["Delta Phase"](#) on page 490

**[:SOURce<hw>]:PHASe:REFerence**

Assigns the value set with command [\[:SOURce<hw>\]:PHASe](#) as the reference phase.

**Example:** See [Example "Programming Example"](#) on page 1264.

**Usage:** Event

**Manual operation:** See ["Reset Delta Phase Display"](#) on page 491

**14.19.18 SOURce:POWer subsystem**

The `SOURce:POWer` subsystem contains the commands for setting the output level, level control and level correction of the RF signal.

The default units are dBm. To change the units, perform one of the following:

- Enter the unit after the numerical value  
Example: `:POW 0.5V`
- Set the unit with the command `:UNIT:POWer`.



**Example: Power configuration**

```

:SOURce1:POWer;CW?
// Response -30
:SOURce1:POWer:CW -25
:SOURce1:POWer:OFFSet?
// Response 0
:SOURce1:POWer:OFFSet 2

:SOURce1:POWer:STEP:MODE?
// Response: DEC
:SOURce1:POWer:STEP:MODE USER
:SOURce1:POWer:STEP:INCRement 2
:SOURce1:POWer:LEVel:IMMediate:AMPLitude UP

```

**Example: Configure the settings for NRP power control**

The example shows a command sequence to configure the parameters for a closed loop power control setup. It is assumed that you have set up the measurement with the amplifier, external coupler, the power sensor and the R&S SMW200A as described in [Section 8.12.4.3, "NRP power control"](#), on page 605.

```

// Reset the instrument to start from an initial state
*RST; *CLS

// Select the sensor used for nrp power control
// that is e.g., connected to a second USB interface

:SOURce1:POWer:SPC:SElect SENS2

// Configure the nrp power control settings
// use the measured peak power for power control
// set the unit dBm for the target level value
// set the target level, e.g. - 10 dBmM
// use the measured target level as reference level
// select single measurement mode to acquire one level value
// set the capture range for the control loop, e.g. +/- 15 dB
// set a time delay between the sensor readings, e.g. 2 ms

:SOURce1:POWer:SPC:PEAK ON
:SENSE1:UNIT:POWer DMB
:SOURce1:POWer:SPC:TARGet -10
:SOURce1:POWer:SPC:MEASure
:SOURce1:POWer:SPC:MODE SINGLE
:SOURce1:POWer:SPC:CRANge 15
:SOURce1:POWer:SPC:DELay 2 ms

// Enable NRP power control measurement
// switch on RF output
// start the single measurement manually

```

```

:Output1:STATe 1
:SOURce1:POWer:SPC:STATe ON
:SOURce1:POWer:SPC:SINGle

// Query if the power control works properly
:SOURce1:POWer:SPC:WARning?
// Response: 1 -> power control does not work as expected

[:SOURce<hw>]:POWer:ALC:MODE?..... 1267
[:SOURce<hw>]:POWer:ALC[:STATe]..... 1267
[:SOURce<hw>]:POWer:ALC:DAMPliFier..... 1268
[:SOURce<hw>]:POWer:ALC:DSensitivity..... 1268
[:SOURce<hw>]:POWer:ALC:SONCe..... 1268
[:SOURce<hw>]:POWer:ALC:SLEVel..... 1269
[:SOURce<hw>]:POWer:AATenuation?..... 1269
[:SOURce<hw>]:POWer:ATTenuation..... 1269
[:SOURce<hw>]:POWer:ATTenuation:INACTive:INDices..... 1269
[:SOURce<hw>]:POWer:ATTenuation:DIGital..... 1270
[:SOURce<hw>]:POWer:ATTenuation:RFOFF:MODE..... 1270
[:SOURce<hw>]:POWer:EMF:STATe..... 1270
[:SOURce<hw>]:POWer:LBEHaviour..... 1271
[:SOURce<hw>]:POWer:LIMit[:AMPLitude]..... 1271
[:SOURce<hw>]:POWer:LMODe..... 1271
[:SOURce<hw>]:POWer:MANual..... 1272
[:SOURce<hw>]:POWer:MODE..... 1272
[:SOURce<hw>]:POWer:PEP?..... 1273
[:SOURce<hw>]:POWer:POWer..... 1273
[:SOURce<hw>]:POWer:START..... 1274
[:SOURce<hw>]:POWer:STOP..... 1274
[:SOURce<hw>]:POWer:SPC:CRANge..... 1274
[:SOURce<hw>]:POWer:SPC:DELAy..... 1274
[:SOURce<hw>]:POWer:SPC:MEASure..... 1275
[:SOURce<hw>]:POWer:SPC:MODE..... 1275
[:SOURce<hw>]:POWer:SPC:PEAK..... 1275
[:SOURce<hw>]:POWer:SPC:SElect..... 1275
[:SOURce<hw>]:POWer:SPC:SINGle..... 1276
[:SOURce<hw>]:POWer:SPC:STATe..... 1276
[:SOURce<hw>]:POWer:SPC:TARGet..... 1276
[:SOURce<hw>]:POWer:SPC:WARning?..... 1276
[:SOURce<hw>]:POWer:STEP:MODE..... 1277
[:SOURce<hw>]:POWer:STEP[:INCRement]..... 1277
[:SOURce<hw>]:POWer[:LEVel][:IMMediate]:OFFSet..... 1278
[:SOURce<hw>]:POWer[:LEVel][:IMMediate]:RCL..... 1278
[:SOURce<hw>]:POWer[:LEVel][:IMMediate][:AMPLitude]..... 1279
[:SOURce<hw>]:POWer[:LEVel][:IMMediate]:REFLevel..... 1279
[:SOURce<hw>]:POWer:RANGe:LOWer?..... 1280
[:SOURce<hw>]:POWer:RANGe:UPPer?..... 1280
[:SOURce]:POWer:WIGNore..... 1280

```

---

**[ :SOURce<hw> ] :POWer:ALC:MODE?**

Queries the currently set ALC mode.

See [ :SOURce<hw> ] :POWer:ALC [ :STATe ] on page 1267.

**Return values:**

<PowAlcMode> 0 | AUTO | 1 | PRESet | OFFTable | ON | OFF | ONSample | ONTable

**Example:**

POW:ALC:MODE?

Response: ONTable"Table and On" is set automatically.

**Usage:**

Query only

**Manual operation:** See "Mode" on page 587

---

**[ :SOURce<hw> ] :POWer:ALC [ :STATe ] <State>**

Activates automatic level control in the selected mode.

How to: See [Section 8.12.2.3, "How to enable the ALC"](#), on page 588.

**Parameters:**

<State> AUTO | OFFTable | ON | ONSample | ONTable | OFF

**AUTO**

Adjusts the output level to the operating conditions automatically.

**OFFTable**

Controls the level with the attenuation values of the internal ALC table.

**ON**

Activates internal level control permanently.

**OFF**

Deactivates internal level control, "Sample & Hold" mode is active.

**ONSample**

Starts the internal level control with the first change.

**ONTable**

Starts with the attenuation setting from the table and continues with automatic level control.

\*RST: AUTO

For more details on the individual settings, an overview of the functionality and details on what is to be considered, see "[ALC states and their effects](#)" on page 584.

**Example:**

POW:ALC ON

Activates internal level control.

**Manual operation:** See "State" on page 586

---

**[:SOURce<hw>]:POWer:ALC:DAMPlifier <Amplifier>**

Selects the driver amplifier switching state.

**Parameters:**

<Amplifier>            OFF | ON | AUTO | FIX | ONMG

**AUTO**  
Switches the attenuator automatically.

**ON|OFF**  
Switches on or off the driver amplifier.

**FIXed**  
Fixes the last setting.

**ONMG**  
Supplies maximum level at the output.

\*RST:            AUTO

**Example:**

POW:ALC:DAMP AUTO  
Provides automatic switching of the attenuator.

**Manual operation:** See "[Driver Amplifier](#)" on page 587

---

**[:SOURce<hw>]:POWer:ALC:DSENSitivity <Sensitivity>**

Sets the sensitivity of the ALC detector.

**Parameters:**

<Sensitivity>            AUTO | FIXed | LOW | MEDium | HIGH

**AUTO**  
Selects the optimum sensitivity automatically.

**LOW|MEDium|HIGH**  
Sets either low, medium or high sensitivity.

**FIXed**  
Fixes the internal level detector.

\*RST:            AUTO

**Example:**

POW:ALC:DSEN FIX

**Manual operation:** See "[Detector Sensitivity](#)" on page 587

---

**[:SOURce<hw>]:POWer:ALC:SONCe**

Activates level control for correction purposes temporarily.

**Example:**

POW:ALC OFF  
Deactivates automatic level control at the RF output.

POW:ALC:SONC  
Executes level control (once).

**Usage:**            Event

**Manual operation:** See "[Readjust](#)" on page 489

---

**[:SOURce<hw>]:POWER:ALC:SLEVel <SampLevel>**

Sets the sample level of automatic level control (ALC).

How To: See [Section 8.12.2.3, "How to enable the ALC"](#), on page 588.

**Parameters:**

<SampLevel> FULL | MINimum | ATTenuated  
\*RST: FULL

**Example:**

POW:ALC:SLEV MIN  
Sets the maximum attenuation.

**Manual operation:** See ["Sample Level"](#) on page 588

---

**[:SOURce<hw>]:POWER:AATTenuation?**

Queries the currently active level attenuation.

**Return values:**

<ActiveAtt> float  
Range: 0 to 110  
Increment: 10  
\*RST: 0

**Example:**

SOURce1:POWER:AATTenuation?  
// Response: 100

**Usage:**

Query only

**Manual operation:** See ["Attenuation Active"](#) on page 583

---

**[:SOURce<hw>]:POWER:ATTenuation <Attenuation>**

Sets the attenuation value of the RF signal in manual mode, set with command :  
[OUTPut<hw>:AMODE](#).

**Parameters:**

<Attenuation> integer  
Range: depends on the installed options  
Increment: 4|5|6  
\*RST: 0

**Example:**

SOURce1:POWER:ATTenuation 20dB

**Manual operation:** See ["Attenuation"](#) on page 583

---

**[:SOURce<hw>]:POWER:ATTenuation:INACTIVE:INDices <InactiveIndices>**

Queries inactive attenuations.

Queries inactive attenuations. The response of the query returns the indices of the attenuations.

**Parameters:**

&lt;InactiveIndices&gt;

**Example:**

SOURce1:POWer:ATTenuation:INACTive:INDices?

**[[:SOURce<hw>]:POWer:ATTenuation:DIGital <AttDigital>**

Sets a relative attenuation value for the baseband signal.

**Parameters:**

&lt;AttDigital&gt;

float

Range: -3.522 to 80

Increment: 1E-3

\*RST: 0

**Manual operation:** See "[Digital Attenuation](#)" on page 487**[[:SOURce<hw>]:POWer:ATTenuation:RFOff:MODE <Mode>**

Selects the state the attenuator is to assume if the RF signal is switched off.

**Parameters:**

&lt;Mode&gt;

UNCHanged | FATTenuation

**FATTenuation**

The step attenuator switches to maximum attenuation when RF is off.

**Note:** This setting overrides the RF level modes :[OUTPut<hw>:AMODEFIXed](#) | [MANual](#).**UNCHanged**

Freezes the current setting to keep the output impedance constant during RF off.

\*RST: n.a. (preset & factory preset depends on option)  
RFmax ≤12.75 GHz: FATTenuation,  
RFmax >12.75 GHz: UNCHanged**Example:**

SOUR:POW:ATT:RFOF:MODE FATT

uses maximum attenuation when the RF output is turned off.

**Manual operation:** See "[RF OFF Mode](#)" on page 583**[[:SOURce<hw>]:POWer:EMF:STATe <State>**

Displays the signal level as voltage of the EMF. The displayed value represents the voltage over a 50 Ohm load.

**Parameters:**

&lt;State&gt;

1 | ON | 0 | OFF

\*RST: n.a. (factory preset: 0)

**Example:**

POW:EMF:STAT 1

Activates voltage level display.

**Manual operation:** See ["Display Level as Voltage of EMF"](#) on page 740

---

**[ :SOURce<hw>]:POWER:LBEHaviour <Behaviour>**

Selects the level behavior at the RF output over time.

**Parameters:**

<Behaviour>

AUTO | UNINterrupted | MONotone | CVSWr | CPHase

**UNINterrupted|MONotone**

Do not use the uninterrupted level settings and strictly monotone modes in combination with the high-quality optimization mode (see [\[:SOURce<hw>\]:BB:IMPairment:OPTimization:MODE](#) on page 1173)

**CVSWr**

Constant VSWR

**CPHase**

Continuous phase

**CONStant**

Constant phase

\*RST: AUTO

**Example:** SOURce1:POWER:LBEHaviour AUTO

**Manual operation:** See ["Setting Characteristics"](#) on page 487

---

**[ :SOURce<hw>]:POWER:LIMit[:AMPLitude] <Amplitude>**

Limits the maximum RF output level in CW and sweep mode.

It does not influence the "Level" display or the response to the query [\[:SOURce<hw>\]:POWER\[:LEVel\] \[:IMMediate\] \[:AMPLitude\]](#).

**Parameters:**

<Amplitude>

float

Range: depends on the installed options

Increment: 0.01

\*RST: n.a. (factory preset: 30)

**Example:** SOURce1:POWER:LIMit:AMPLitude 10

**Manual operation:** See ["Limit"](#) on page 489

---

**[ :SOURce<hw>]:POWER:LMODe <LevMode>**

Sets the RF level mode.

**Parameters:**

<LevMode>

NORMal | LOWNoise | LOWDistortion

**NORMAL**

Supplies the RF signal with the standard power level of the instrument.

**LOWNoise**

Supplies a very low noise sinewave signal.

**LOWDistortion**

Supplies a very pure sinewave signal.

\*RST:        NORMAl

**Example:**

SOURce1:POWer:LMODe LOWD

Sets low distortion mode. The instrument reduces distortions of the RF signal to a minimum.

**Manual operation:** See ["Mode"](#) on page 487

**[[:SOURce<hw>]:POWer:MANual <Manual>**

Sets the level for the subsequent sweep step if [SWE:POW:MODE MAN](#).

Use a separate command for each sweep step.

**Parameters:**

<Manual>            float

You can select any level within the setting range, where:

START is set with [\[:SOURce<hw>\]:POWer:START](#)

STOP is set with [\[:SOURce<hw>\]:POWer:STOP](#)

OFFSet is set with [\[:SOURce<hw>\]:POWer\[:LEVel\]\[:IMMediate\]:OFFSet](#)

Range:        (START + OFFSet) to (STOP + OFFSet)

Increment:   0.01

Default unit: dBm

**Example:**

See [Example "Setup an RF frequency or power sweep"](#) on page 1288

**Manual operation:** See ["Current Level"](#) on page 527

**[[:SOURce<hw>]:POWer:MODE <Mode>**

Selects the operating mode of the instrument to set the output level.

**Parameters:**

<Mode>            CW | FIXed | SWEep

**CW|FIXed**

Operates at a constant level.

CW and FIXed are synonyms.

To set the output level value, use the command [\[:SOURce<hw>\]:POWer\[:LEVel\]\[:IMMediate\]\[:AMPLitude\]](#).



**SWEp**

Sets sweep mode.

Set the range and current level with the commands:

```
[ :SOURce<hw> ] :POWer:STARt and [ :SOURce<hw> ] :
POWer:STOP,
[ :SOURce<hw> ] :POWer:MANual.
```

\*RST: CW

**Example:** See [Example "Setup an RF frequency or power sweep"](#) on page 1288

**Manual operation:** See ["State \(RF level sweep\)"](#) on page 527

**[ :SOURce<hw> ] :POWer:PEP?**

Queries the PEP (**P**eak **E**nvelope **P**ower) of digital modulation or digital standards at the RF output. This value corresponds to the level specification, displayed in the status bar (header).

**Return values:**

<Pep> float

**Example:**

```
POW:PEP?
Response: "4"
```

The PEP value of digital modulation is 4 dBm at the RF output.

**Usage:** Query only

**Manual operation:** See ["PEP"](#) on page 479

**[ :SOURce<hw> ] :POWer:POWer <Power>**

Sets the level **at the RF output** connector.

This value does not consider a specified offset.

The command `[ :SOURce<hw> ] :POWer [ :LEVel ] [ :IMMediate ] [ :AMPLitude ]` sets the level of the "Level" display, that means the level containing offset.

See [Section 8.4.1.1, "Displayed RF frequency and level values with downstream instruments"](#), on page 480.

**Parameters:**

<Power> float  
 Level at the RF output, without level offset  
 Range: See specifications document.  
 Increment: 0.01  
 Default unit: dBm

**Example:**

```
SOURce1:POWer:POWer 15
// sets the level at the RF output.
```

**Manual operation:** See ["Amplitude"](#) on page 486  
 See ["Generator Settings used for Measurement"](#) on page 597

---

**[ :SOURce<hw> ]:POWER:START <Start>**

**[ :SOURce<hw> ]:POWER:STOP <Stop>**

Sets the RF start/stop level in sweep mode.

**Parameters:**

<Stop>

float

Sets the setting range calculated as follows:

(Level\_min + OFFSet) to (Level\_max + OFFSet)

Where the values are set with the commands:

[ :SOURce<hw> ]:POWER[:LEVel] [:IMMediate]:OFFSet

[ :SOURce<hw> ]:POWER:START

[ :SOURce<hw> ]:POWER:STOP

Range: Minimum level to maximum level

\*RST: -30 (Start)/ -10 (Stop)

Default unit: dBm

**Example:**

See [Example "Setup an RF frequency or power sweep"](#) on page 1288

**Manual operation:** See ["Start Level / Stop Level"](#) on page 533

---

**[ :SOURce<hw> ]:POWER:SPC:CRANge <PowCntrlCRange>**

Defines the capture range of the power control system.

Within the range:

*Target Level +/- Catch Range*

the power control locks and tries to achieve the target level. Readings outside the range are not considered.

**Parameters:**

<PowCntrlCRange> float

Range: 0 to 50

Increment: 0.01

\*RST: 30

**Example:**

See [Example "Configure the settings for NRP power control"](#) on page 1265

**Manual operation:** See ["Catch Range +/-"](#) on page 608

---

**[ :SOURce<hw> ]:POWER:SPC:DELay <PowCntrlDelay>**

Sets a waiting time for the generator to adjust the output level. After the delay time has elapsed, the power sensor measures the next value.

**Parameters:**

<PowCntrlDelay> integer

Range: 0 to 1000

\*RST: 0

**Example:** See [Example "Configure the settings for NRP power control"](#) on page 1265

**Manual operation:** See ["Delay Time"](#) on page 608

#### **[ :SOURce<hw>]:POWER:SPC:MEASure**

Sets the measured power value as reference level.

**Example:** See [Example "Configure the settings for NRP power control"](#) on page 1265

**Usage:** Event

**Manual operation:** See ["Take Measurement as Target Level"](#) on page 607

#### **[ :SOURce<hw>]:POWER:SPC:MODE <ControlMode>**

Selects the measurement mode for the power sensor.

**Parameters:**

<ControlMode> AUTO | SINGle

**AUTO**

Measures the level values continuously.

**SINGle**

Executes one measurement, triggered by the command [ :SOURce<hw>]:POWER:SPC:SINGle on page 1276.

\*RST: AUTO

**Example:** See [Example "Configure the settings for NRP power control"](#) on page 1265

**Manual operation:** See ["Mode"](#) on page 607

#### **[ :SOURce<hw>]:POWER:SPC:PEAK <PowCntrlPeak>**

Activates power control by means of the peak power values, provided the power sensor supports this function.

**Parameters:**

<PowCntrlPeak> 1 | ON | 0 | OFF

\*RST: 0

**Example:** See [Example "Configure the settings for NRP power control"](#) on page 1265

#### **[ :SOURce<hw>]:POWER:SPC:SElect <PowCntrlSelect>**

Selects the power sensor used for power control.

**Parameters:**

<PowCntrlSelect> SENS1 | SENS2 | SENS3 | SENS4 | SENSor1 | SENSor2 |  
SENSor3 | SENSor4  
\*RST: SENS1

**Example:** See [Example "Configure the settings for NRP power control"](#) on page 1265

**Manual operation:** See ["Sensor"](#) on page 607

**[:SOURce<hw>]:POWER:SPC:SINGLE**

Triggers the power sensor to measure the power value once.

**Usage:** Event

**Manual operation:** See ["Execute Single"](#) on page 608

**[:SOURce<hw>]:POWER:SPC:STATe <PowCntrlState>**

Starts power control using the selected sensor. The control loop periodically adjusts the output level of the signal generator. After switching off, the running loop is completed.

**Parameters:**

<PowCntrlState> 1 | ON | 0 | OFF  
\*RST: 0

**Example:** See [Example "Configure the settings for NRP power control"](#) on page 1265

**Manual operation:** See ["State"](#) on page 607

**[:SOURce<hw>]:POWER:SPC:TARGeT <PowCntrlTarget>**

Sets the target level required at the DUT. To define the unit of the power value, use command [:UNIT:POWer](#) on page 1340.

**Parameters:**

<PowCntrlTarget> float  
Range: -50 to 30  
Increment: 0.01  
\*RST: -10

**Example:** See [Example "Configure the settings for NRP power control"](#) on page 1265

**Manual operation:** See ["Target Level"](#) on page 607

**[:SOURce<hw>]:POWER:SPC:WARNing?**

Queries if the activated power control works properly.

If the power control does not work, the query returns warning state 1. On the screen, the R&S SMW200A indicates a warning icon.

**Return values:**

<WarningState> 1 | ON | 0 | OFF  
\*RST: 0

**Example:** See [Example "Configure the settings for NRP power control"](#) on page 1265.

**Usage:** Query only

**[ :SOURce<hw>]:POWER:STEP:MODE <Mode>**

Defines the type of step width to vary the RF output power step-by-step with the commands [POW UP](#) or [POW DOWN](#).

You can define the step mode for each path separately.

**Parameters:**

<Mode> DECimal | USER

**DECimal**

Increases or decreases the level in steps of ten.

**USER**

Increases or decreases the level in increments, determined with the command [\[:SOURce<hw>\]:POWER:STEP\[:INCRement\]](#).

\*RST: DECimal

**Example:** See [Example "Power configuration"](#) on page 1265.

**Manual operation:** See ["Variation Active"](#) on page 485

**[ :SOURce<hw>]:POWER:STEP[:INCRement] <Increment>**

Specifies the step width in the appropriate path for [POW:STEP:MODE USER](#).

To adjust the level step-by-step with this increment value, use the command [POW UP](#), or [POW DOWN](#).

**Note:** The command also sets "Variation Step" in the manual control, that means the user-defined step width for setting the level with the rotary knob or the [Up/Down] arrow keys.

**Parameters:**

<Increment> float  
Range: 0 to 200  
Increment: 0.01  
\*RST: 1  
Default unit: dB

**Example:** See [Example "Power configuration"](#) on page 1265.

**Manual operation:** See ["Variation Step"](#) on page 485

**[ :SOURce<hw> ] :POWer [ :LEVel ] [ :IMMediate ] :OFFSet <Offset>**

Sets the level offset of a downstream instrument.

The level at the RF output is not changed.

To query the resulting level, as it is at the output of the downstream instrument, use the command `[ :SOURce<hw> ] :POWer [ :LEVel ] [ :IMMediate ] [ :AMPLitude ]`.

See [Section 8.4.1.1, "Displayed RF frequency and level values with downstream instruments"](#), on page 480.

**Note:** The level offset also affects the RF level sweep.

**Parameters:**

<Offset>	float
	Range: -100 to 100
	Increment: 0.01
	*RST: 0
	Default unit: dB
	Level offset is always expreced in dB; linear units (V, W, etc.) are not supported

**Example:**

```
POWer:OFFSet 10
Sets the RF level offset to 10 dB
```

**Manual operation:**

See ["Offset"](#) on page 489  
See ["Generator Settings used for Measurement"](#) on page 597

**[ :SOURce<hw> ] :POWer [ :LEVel ] [ :IMMediate ] :RCL <Rcl>**

Determines whether the current level is retained or if the stored level setting is adopted when an instrument configuration is loaded.

The setting is valid for both paths. If a suffix is specified, it is ignored.

**Parameters:**

<Rcl>	INCLude   EXCLude
	<b>INCLude</b>
	Takes the current level when an instrument configuration is loaded.
	<b>EXCLude</b>
	Retains the current level when an instrument configuration is loaded.
	*RST: INCLude

**Example:**

```
POW:RCL INCL
Takes the level value from an instrument configuration loaded with command *RCL.
```

**Manual operation:**

See ["Exclude Level"](#) on page 712

---

**[ :SOURce<hw>]:POWER[:LEVel][:IMMediate][:AMPLitude] <Amplitude>**

Sets the RF level applied to the DUT.

To activate the RF output use command `:OUTPut<hw>[:STATe]` ("RF On"/"RF Off").

The following applies  $POWER = RF\ output\ level + OFFSET$ , where:

- `POWER` is the values set with `[ :SOURce<hw>]:POWER[:LEVel][:IMMediate][:AMPLitude]`
- RF output level is set with `[ :SOURce<hw>]:POWER:POWER`
- `OFFSET` is set with `[ :SOURce<hw>]:POWER[:LEVel][:IMMediate]:OFFSet`

**Parameters:**

<Amplitude>

float

The following settings influence the value range:

`OFFSET` set with the command `[ :SOURce<hw>]:POWER[:LEVel][:IMMediate]:OFFSet`

**Numerical value**

Sets the level

**UP|DOWN**

Varies the level step by step.

The level is increased or decreased by the value set with the command `[ :SOURce<hw>]:POWER:STEP[:INCRement]`.

Range: (Level\_min + OFFSet) to (Level\_max + OFFSet)

\*RST: -30

Default unit: dBm

**Example:**

`POWER -30`

Sets the RF level

**Example:**

See also `[ :SOURce<hw>]:POWER:STEP:MODE` on page 1277.

**Manual operation:**

See "Amplitude" on page 486

---

**[ :SOURce<hw>]:POWER[:LEVel][:IMMediate]:REFLevel <ReferenceLevel>**

Queries the reference level of the user correction.

The reference level is the sum of the amplitude and the level offset, set with the commands `[ :SOURce<hw>]:POWER:POWER [ :SOURce<hw>]:POWER[:LEVel][:IMMediate]:OFFSet`.

**Parameters:**

<ReferenceLevel>

float

Range: -245 to 120

Increment: 0.01

\*RST: -30

**Manual operation:**

See "Generator Settings used for Measurement" on page 597

---

**[[:SOURce<hw>]:POWER:RANGe:LOWer?**

**[[:SOURce<hw>]:POWER:RANGe:UPPer?**

Queries the current interruption-free range of the level.

**Return values:**

<Upper> float  
Increment: 0.01  
Default unit: dBm

**Example:**

```
SOURce1:POWER:RANGe:UPPer?  
// -15  
SOURce1:POWER:RANGe:LOW?  
// -50
```

**Usage:** Query only

**Manual operation:** See "[Level Range](#)" on page 535

---

**[[:SOURce]:POWER:WIGNore <State>**

Ignores level range warnings.

**Parameters:**

<State> 1 | ON | 0 | OFF  
\*RST: n.a. (factory preset: 0)

**Example:** SOURce:POWER:WIGNore 1

### 14.19.19 SOURce:ROSCillator subsystem

The SOURce:ROSCillator subsystem contains the commands for setting the external and internal reference frequency.



**Example: Configuring the reference oscillator**

```

// Using 100 MHz external reference source
SOURce:ROSCillator:PRESet
SOURce:ROSCillator:SOURce EXT
SOURce:ROSCillator:EXTernal:RFOFF:STATe 1
SOURce:ROSCillator:EXTernal:FREQuency 100MHZ
SOURce:ROSCillator:EXTernal:SBANDwidth WIDE
// 100 MHz (loop through) and 1 GHz output
SOURce:ROSCillator:OUTPut:FREQuency:MODE LOOP
SOURce:ROSCillator:OUTPut:ALternate:FREQuency:MODE DER1G
SOURce:ROSCillator:INTernal:ADJust:STATe 0

// Variable external reference frequency
// SOURce:ROSCillator:EXTernal:FREQuency VAR
// SOURce:ROSCillator:EXTernal:FREQuency:VARIABLE 10000000

// Using the internal reference frequency
SOURce:ROSCillator:SOURce INT
SOURce:ROSCillator:INTernal:TUNing:STATe 1
SOURce:ROSCillator:INTernal:TUNing:SLOPe LOW
// 10 MHz and 1 GHz output
SOURce:ROSCillator:OUTPut:FREQuency:MODE DER10M
SOURce:ROSCillator:OUTPut:ALternate:FREQuency:MODE DER1G

// Using 10 MHz external reference source
SOURce:ROSCillator:SOURce EXT
SOURce:ROSCillator:EXTernal:RFOFF:STATe 1
SOURce:ROSCillator:EXTernal:FREQuency?
// Response: 10MHZ
SOURce:ROSCillator:EXTernal:SBANDwidth WIDE
SOURce:ROSCillator:INTernal:ADJust:STATe 0

// Query calibration value
CALibration:ROSCillator?
// 32767
// Set an internal source
// Activate user-defined adjustment value of 1000
SOURce:ROSCillator:SOURce INT
SOURce:ROSCillator:INTernal:ADJust:STATe 1
SOURce:ROSCillator:INTernal:ADJust:VALue 1000

// to resume calibrated state
SOURce:ROSCillator:INTernal:ADJust:VALue 0
SOURce:ROSCillator:INTernal:ADJust:STATe 0
// or
// SYSTem:FPReSt

```

<a href="#">[:SOURce]:ROSCillator:SOURce</a> .....	1282
<a href="#">[:SOURce]:ROSCillator:EXTernal:RFOFF[:STATe]</a> .....	1282
<a href="#">[:SOURce]:ROSCillator:EXTernal:FREQuency</a> .....	1282
<a href="#">[:SOURce]:ROSCillator:EXTernal:FREQuency:VARIABLE</a> .....	1282

<code>[:SOURce]:ROSCillator:EXTernal:SBANdwidth</code> .....	1283
<code>[:SOURce]:ROSCillator:EXTernal:MLRange?</code> .....	1283
<code>[:SOURce]:ROSCillator:EXTernal:NSBandwidth?</code> .....	1284
<code>[:SOURce]:ROSCillator:OUTPut:FREQuency:MODE</code> .....	1284
<code>[:SOURce]:ROSCillator[:INTernal]:ADJust:VALue</code> .....	1284
<code>[:SOURce]:ROSCillator[:INTernal]:ADJust[:STATe]</code> .....	1284

---

#### `[:SOURce]:ROSCillator:SOURce <Source>`

Selects between internal or external reference frequency.

##### Parameters:

`<Source>`                    INTernal | EXTernal  
 \*RST:                    n.a. (factory preset: INTernal)

**Example:**                    See [Example "Configuring the reference oscillator"](#) on page 1281.

**Manual operation:**    See ["Source"](#) on page 492

---

#### `[:SOURce]:ROSCillator:EXTernal:RFOFF[:STATe] <State>`

Determines that the RF output is turned off when the external reference signal is selected, but missing.

##### Parameters:

`<State>`                    1 | ON | 0 | OFF  
 \*RST:                    n.a. (factory preset: 0)

**Example:**                    See [Example "Configuring the reference oscillator"](#) on page 1281.

**Manual operation:**    See ["Deactivate RF Output \(if external reference is missing\)"](#) on page 493

---

#### `[:SOURce]:ROSCillator:EXTernal:FREQuency <Frequency>`

Sets the frequency of the external reference.

##### Parameters:

`<Frequency>`                10MHZ | VARiable | 5MHZ | 13MHZ  
 \*RST:                    n.a. (factory preset: 10MHZ)

**Example:**                    See [Example "Configuring the reference oscillator"](#) on page 1281.

**Manual operation:**    See ["External Reference Frequency"](#) on page 493

---

#### `[:SOURce]:ROSCillator:EXTernal:FREQuency:VARiable <Frequency>`

Specifies the user-defined external reference frequency.

**Parameters:**

<Frequency> float  
 Range: 1E6 to 100E6  
 Increment: 0.1  
 \*RST: n.a. (factory preset: 1E7)  
 Default unit: Hz

**Example:** See [Example "Configuring the reference oscillator"](#) on page 1281.

**Options:** R&S SMW-K704

**Manual operation:** See ["Variable Reference Frequency"](#) on page 494

**[[:SOURce]:ROSCillator:EXTernal:SBANDwidth <SBandwidth>**

Selects the synchronization bandwidth for the external reference signal.

Depending on the RF hardware version and the installed options, the synchronization bandwidth varies.

For more information, refer to the specifications document.

**Parameters:**

<SBandwidth> WIDE | NARRow  
**NARRow**  
 The synchronization bandwidth is smaller than 1 Hz.  
**WIDE**  
 Uses the widest possible synchronization bandwidth.  
 \*RST: n.a. (factory preset: WIDE)

**Example:** See [Example "Configuring the reference oscillator"](#) on page 1281.

**Manual operation:** See ["Synchronization Bandwidth"](#) on page 494

**[[:SOURce]:ROSCillator:EXTernal:MLRange?**

Queries the minimum locking range for the selected external reference frequency.

Depending on the RF hardware version, and the installed options, the minimum locking range varies.

For more information, refer to the specifications document.

**Return values:**

<MinLockRange> string

**Example:** SOUR:ROSC:EXT:MLR?

**Usage:** Query only

**Manual operation:** See ["Minimum Locking Range"](#) on page 495

---

**[[:SOURce]:ROSCillator:EXTernal:NSBandwidth?**

Queries the nominal synchronization bandwidth for the selected external reference frequency and synchronization bandwidth.

**Return values:**

<NomBandwidth>      string

**Example:**              SOUR:ROSC:EXT:NSB?

**Usage:**                Query only

**Manual operation:**   See "[Nominal Synchronization Bandwidth](#)" on page 494

---

**[[:SOURce]:ROSCillator:OUTPut:FREQuency:MODE <OutpFreqMode>**

Selects the mode for the determination and output of the reference frequency.

**Parameters:**

<OutpFreqMode>      DER10M | SAME

\*RST:                  n.a. (factory preset: DER10M)

**Example:**              See [Example "Configuring the reference oscillator"](#) on page 1281.

**Manual operation:**   See "[Reference Output/1 GHz Reference Output](#)" on page 495

---

**[[:SOURce]:ROSCillator[:INTernal]:ADJust:VALue <Value>**

Specifies the frequency correction value (adjustment value).

**Parameters:**

<Value>                integer

\*RST:                  0

**Example:**              See [\[:SOURce\]:ROSCillator\[:INTernal\]:ADJust\[:STATe\]](#) on page 1284

**Manual operation:**   See "[Adjustment Value](#)" on page 496

---

**[[:SOURce]:ROSCillator[:INTernal]:ADJust[:STATe] <State>**

Determines whether the calibrated (off) or a user-defined (on) **adjustment value** is used for fine adjustment of the frequency.

**Parameters:**

<State>                1 | ON | 0 | OFF

**0**

Fine adjustment with the calibrated frequency value

**1**

User-defined adjustment value.

The instrument is no longer in the calibrated state.

The calibration value is, however, not changed. The instrument resumes the calibrated state if you send

```
SOURce:ROSCillator:INTernal:ADJust:STATE 0.
```

```
*RST:      n.a. (factory preset: 0)
```

**Example:** See [Example "Configuring the reference oscillator"](#) on page 1281.

**Manual operation:** See ["Adjustment Active"](#) on page 496

## 14.19.20 RF ports alignment commands

Option: R&S SMW-B9 and R&S SMW-K545

See also [Section 14.18.5, "RF ports alignment commands"](#), on page 996.

<a href="#">:SOURce&lt;hw&gt;:RFALignment:CALibrated:FREQUENCY?</a> .....	1285
<a href="#">:SOURce&lt;hw&gt;:RFALignment:CALibrated:POWER:PEP?</a> .....	1285
<a href="#">:SOURce&lt;hw&gt;:RFALignment:FOFFset?</a> .....	1286
<a href="#">:SOURce&lt;hw&gt;:RFALignment:DATTenuation?</a> .....	1286
<a href="#">:SOURce&lt;hw&gt;:RFALignment:CORRection:PHASe?</a> .....	1286
<a href="#">:SOURce&lt;hw&gt;:RFALignment:CORRection:LEVel?</a> .....	1286
<a href="#">:SOURce&lt;hw&gt;:RFALignment:CORRection:IQDelay?</a> .....	1287

---

### **:SOURce<hw>:RFALignment:CALibrated:FREQUENCY?**

Queries the frequency for that the calibration data is valid.

**Return values:**

```
<CalibratedFreq>      float
                        Increment: 0.01
```

**Example:** See [Example "Retrieving details on the calibrated values"](#) on page 997.

**Usage:** Query only

**Manual operation:** See ["Calibrated Frequency"](#) on page 688

---

### **:SOURce<hw>:RFALignment:CALibrated:POWER:PEP?**

Queries the PEP for that the calibration data is valid.

**Return values:**

```
<PEP>                  float
                        Increment: 0.01
```

**Example:** See [Example "Retrieving details on the calibrated values"](#) on page 997.

**Usage:** Query only  
**Manual operation:** See ["Calibrated Level \(PEP\)"](#) on page 688

#### :SOURce<hw>:RFALignment:FOFFset?

Queries the applied baseband frequency offset.

**Return values:**  
 <BbFreqOffset> float  
 Increment: 0.01

**Example:** See [Example "Retrieving details on the calibrated values"](#) on page 997.

**Usage:** Query only  
**Manual operation:** See ["Baseband Frequency Offset"](#) on page 689

#### :SOURce<hw>:RFALignment:DATTenuation?

Queries the applied digital attenuation.

**Return values:**  
 <Attenuation> float  
 Increment: 0.01

**Example:** See [Example "Retrieving details on the calibrated values"](#) on page 997.

**Usage:** Query only  
**Manual operation:** See ["Digital Attenuation"](#) on page 689

#### :SOURce<hw>:RFALignment:CORRection:PHASe?

queries the delta phase applied for compensation of the frequency response of the signal.

**Return values:**  
 <Phase> float  
 Increment: 0.01

**Example:** See [Example "Retrieving details on the calibrated values"](#) on page 997.

**Usage:** Query only  
**Manual operation:** See ["Phase"](#) on page 689

#### :SOURce<hw>:RFALignment:CORRection:LEVel?

Queries the level correction applied to the signal of the selected path.

**Return values:**

<Level> float  
Increment: 0.01

**Example:** See [Example "Retrieving details on the calibrated values"](#) on page 997.

**Usage:** Query only

**Manual operation:** See "[Level](#)" on page 689

**:SOURce<hw>:RFAlignment:CORRection:IQDelay?**

Queries the I/Q delay applied for compensation of the frequency response of the signal.

**Return values:**

<IQdelay> float  
Increment: 1E-12

**Example:** See [Example "Retrieving details on the calibrated values"](#) on page 997.

**Usage:** Query only

**Manual operation:** See "[I/Q Delay](#)" on page 689

**14.19.21 SOURce:SWEep subsystem**

The SOURce:SWEep subsystem contains the commands for configuring RF sweep signals.



- The keyword [ :FREQuency] can be omitted, then the commands are SCPI-compliant.
- To activate an RF sweep mode, use the following commands:
  - RF frequency sweep: SOURce:FREQuency:MODE SWEep (SOURce:FREQuency:MODE CW (off))
  - RF level sweep: SOURce:POWEr:MODE SWEep (SOURce:POWEr:MODE CW (off))
- All sweeps, including the LF sweep, can be set independently of each other.
- All sweeps can be set independently of each other.

See [Section 8.10.1, "Signal generation and triggering in the sweep and list modes"](#), on page 511.

**Example: Setup an RF frequency or power sweep**

The following example shows a command sequence to set up an RF frequency sweep, triggered by the execute command. For an RF power sweep, replace `FREQuency` in the `SWEep` commands with `POWEr`.

Exceptions are the power spacing (defined with `LINEar` only) and the power step width (defined with `LOGarithmic` only).

```
// Reset the instrument to start from an initial state
// Switch off display update to improve performance
// (especially with short dwell times)
// Set the sweep mode (first two commands) and the sweep range
// Select linear spacing
// Select the waveform shape for the frequency sweep
*RST; *CLS
SYSTem:DISPlay:UPDate OFF
TRIGger1:FSWEEP:SOURce SINGLE
SOURce1:SWEep:FREQuency:MODE AUTO
SOURce1:FREQuency:SPAN 300 MHz
SOURce1:FREQuency:CENTer 200 MHz
// Alternatively use
// SOURce1:FREQuency:START 50 MHz
// SOURce1:FREQuency:STOP 350 MHz
SOURce1:SWEep:FREQuency:SPACing LINEar
SOURce1:SWEep:FREQuency:SHAPE SAWTOOTH

// Activate change to start frequency while waiting for next trigger
// Prerequisites: sweep mode single and sweep waveform sawtooth
SOURce1:SWEep:FREQuency:RETRace 1
// Alternatively reset all sweeps to their initial value
SOURce1:SWEep:RESet:ALL

// Set the step width and dwell time
SOURce1:SWEep:FREQuency:STEP:LINEar 1 MHz
// Alternatively set the number of steps, then the sweep step width is
// set automatically
SOURce1:SWEep:FREQuency:POINts 301
SOURce1:SWEep:FREQuency:DWELL 500 ms
// With logarithmic spacing select the step width as follows
// (steps of 10 percent of the previous frequency in each instance)
SOURce1:SWEep:FREQuency:SPACing LOG
SOURce1:SWEep:FREQuency:STEP:LOGarithmic 10PCT

// Activate the sweep
// Trigger the sweep (depending on the set mode) and query the status
SOURce1:FREQuency:MODE SWEep
// Perform a one-off RF frequency sweep
SOURce1:SWEep:FREQuency:EXECute
SOURce1:SWEep:FREQuency:RUNning?
// 1
```



```
// the frequency sweep is running

// For manual step RF sweep use the following commands
*RST; *CLS
// Activate manual step RF sweep
SOURce1:SWEep:FREQuency:MODE MANual
// Activate the RF frequency sweep.
SOURce1:FREQuency:MODE SWEep
// Activate RF Output1.
Output1:STATe 1
// Input the frequency manually for each step
SOURce1:FREQuency:MANual 200 MHz
SOURce1:FREQuency:MANual 201 MHz
// Alternatively use the UP or DOWN commands with the set step width.
SOURce1:SWEep:FREQuency:STEP:LINear 1 MHz
SOURce1:FREQuency:MANual UP
```

<a href="#">[:SOURce&lt;hw&gt;]:SWEep:POWer:AMODE</a> .....	1289
<a href="#">[:SOURce&lt;hw&gt;]:SWEep:POWer:DWELL</a> .....	1290
<a href="#">[:SOURce&lt;hw&gt;]:SWEep:POWer:MODE</a> .....	1290
<a href="#">[:SOURce&lt;hw&gt;]:SWEep:POWer:POINts</a> .....	1290
<a href="#">[:SOURce&lt;hw&gt;]:SWEep:POWer:SPACing:MODE?</a> .....	1291
<a href="#">[:SOURce&lt;hw&gt;]:SWEep:POWer:STEP[:LOGarithmic]</a> .....	1291
<a href="#">[:SOURce&lt;hw&gt;]:SWEep[:FREQuency]:DWELL</a> .....	1291
<a href="#">[:SOURce&lt;hw&gt;]:SWEep[:FREQuency]:MODE</a> .....	1292
<a href="#">[:SOURce&lt;hw&gt;]:SWEep[:FREQuency]:POINts</a> .....	1292
<a href="#">[:SOURce&lt;hw&gt;]:SWEep[:FREQuency]:SPACing</a> .....	1292
<a href="#">[:SOURce&lt;hw&gt;]:SWEep:POWer:SHAPE</a> .....	1293
<a href="#">[:SOURce&lt;hw&gt;]:SWEep[:FREQuency]:SHAPE</a> .....	1293
<a href="#">[:SOURce&lt;hw&gt;]:SWEep:POWer:EXECute</a> .....	1293
<a href="#">[:SOURce&lt;hw&gt;]:SWEep[:FREQuency]:EXECute</a> .....	1293
<a href="#">[:SOURce&lt;hw&gt;]:SWEep:POWer:RETRace</a> .....	1294
<a href="#">[:SOURce&lt;hw&gt;]:SWEep[:FREQuency]:RETRace</a> .....	1294
<a href="#">[:SOURce&lt;hw&gt;]:SWEep:POWer:RUNNing?</a> .....	1294
<a href="#">[:SOURce&lt;hw&gt;]:SWEep[:FREQuency]:RUNNing?</a> .....	1294
<a href="#">[:SOURce&lt;hw&gt;]:SWEep[:FREQuency]:STEP:LOGarithmic</a> .....	1294
<a href="#">[:SOURce&lt;hw&gt;]:SWEep[:FREQuency]:STEP[:LINear]</a> .....	1294
<a href="#">[:SOURce&lt;hw&gt;]:SWEep:RESet[:ALL]</a> .....	1295

---

### **[:SOURce<hw>]:SWEep:POWer:AMODE <AMode>**

Selects the power attenuator mode for the level sweep.

#### **Parameters:**

<AMode>                    NORMAL | HPOWER

#### **NORMAL**

Performs the level settings in the range of the built-in attenuator.

#### **HPOWER**

Performs the level settings in the high level range.

\*RST:            NORMAL(HighPower)|AUTO

**Example:** `SWE:POW:AMOD HPOW`  
Selects the high level ranges for level sweep.

---

**[ :SOURce<hw>]:SWEep:POWer:DWELI <Dwell>**

Sets the dwell time for a level sweep step.

**Parameters:**

<Dwell> float  
Range: 0.001 to 100  
Increment: 100E-6  
\*RST: 0.01

**Example:** See [Example "Setup an RF frequency or power sweep"](#) on page 1288.

**Manual operation:** See ["Dwell Time"](#) on page 529

---

**[ :SOURce<hw>]:SWEep:POWer:MODE <Mode>**

Sets the cycle mode for the level sweep.

**Parameters:**

<Mode> AUTO | MANual | STEP

**AUTO**

Each trigger triggers exactly one complete sweep.

**MANual**

The trigger system is not active. You can trigger every step individually with the command `[ :SOURce<hw>]:POWer:MANual`. The level value increases at each step by the value that you define with `[ :SOURce<hw>]:POWer:STEP[:INCRement]`. Values directly entered with the command `[ :SOURce<hw>]:POWer:MANual` are not taken into account.

**STEP**

Each trigger triggers one sweep step only. The level increases by the value entered with `[ :SOURce<hw>]:POWer:STEP[:INCRement]`.

\*RST: AUTO

**Example:** See [Example "Setup an RF frequency or power sweep"](#) on page 1288.

**Manual operation:** See ["Mode"](#) on page 528

---

**[ :SOURce<hw>]:SWEep:POWer:POINTs <Points>**

Sets the number of steps within the RF level sweep range.

See [Section 8.10.2.1, "Correlating parameters in sweep mode"](#), on page 519.

**Parameters:**

<Points> integer  
 Range: 2 to Max

**Example:** See [Example "Setup an RF frequency or power sweep"](#) on page 1288.

**[[:SOURce<hw>]:SWEep:POWER:SPACing:MODE?**

Queries the level sweep spacing. The sweep spacing for level sweeps is always linear.

**Return values:**

<Mode> LINear  
 \*RST: LINear

**Example:** SWE:POW:SPAC:MODE?  
 queries the sweep spacing for a level sweep at RF output.  
 Result: "LIN"  
 linear spacing

**Usage:** Query only

**[[:SOURce<hw>]:SWEep:POWER:STEP[:LOGarithmic] <Logarithmic>**

Sets a logarithmically determined step size for the RF level sweep. The level is increased by a logarithmically calculated fraction of the current level.

See [Section 8.10.2.1, "Correlating parameters in sweep mode"](#), on page 519.

**Parameters:**

<Logarithmic> float  
 The unit dB is mandatory.  
 Range: 0.01 to 139 dB  
 Increment: 0.01  
 \*RST: 1  
 Default unit: dB

**Example:** See [Example "Setup an RF frequency or power sweep"](#) on page 1288.

**Manual operation:** See ["Step"](#) on page 533

**[[:SOURce<hw>]:SWEep[:FREQuency]:DWELI <Dwell>**

Sets the dwell time for a frequency sweep step.

**Parameters:**

<Dwell> float  
 Range: 0.001 to 100  
 Increment: 100E-6  
 \*RST: 0.01

**Example:** See [Example "Setup an RF frequency or power sweep"](#) on page 1288.

**Manual operation:** See ["Dwell Time"](#) on page 529

**[ :SOURce<hw>]:SWEep[:FREQUENCY]:MODE <Mode>**

Sets the cycle mode for the frequency sweep.

**Parameters:**

<Mode> AUTO | MANual | STEP

**AUTO**

Each trigger event triggers exactly one complete sweep.

**MANual**

The trigger system is not active. You can trigger every step individually by input of the frequencies with the command [ :SOURce<hw>]:FREQUENCY:MANual.

**STEP**

Each trigger event triggers one sweep step. The frequency increases by the value entered with [ :SOURce<hw>]:SWEep[:FREQUENCY]:STEP[:LINear] (linear spacing) or [ :SOURce<hw>]:SWEep[:FREQUENCY]:STEP:LOGarithmic (logarithmic spacing).

\*RST: AUTO

**Example:** See [Example "Setup an RF frequency or power sweep"](#) on page 1288.

**Manual operation:** See ["Mode"](#) on page 528

**[ :SOURce<hw>]:SWEep[:FREQUENCY]:POINTs <Points>**

Sets the number of steps within the RF frequency sweep range.

See [Section 8.10.2.1, "Correlating parameters in sweep mode"](#), on page 519.

Two separate POINTs values are used for linear or logarithmic sweep spacing ([ :SOURce<hw>]:SWEep[:FREQUENCY]:SPACing LIN | LOG). The command always affects the currently set sweep spacing.

**Parameters:**

<Points> integer  
Range: 2 to Max

**Example:** See [Example "Setup an RF frequency or power sweep"](#) on page 1288.

**[ :SOURce<hw>]:SWEep[:FREQUENCY]:SPACing <Spacing>**

Selects the mode for the calculation of the frequency intervals, with which the current frequency at each step is increased or decreased.

The keyword [ :FREQuency] can be omitted; then the command is SCPI-compliant.

**Parameters:**

<Spacing> LINear | LOGarithmic

**LINear**

Sets a fixed frequency value as step width and adds it to the current frequency.

The linear step width is entered in Hz, see [ :SOURce<hw>]:SWEep[:FREQuency]:STEP[:LINear].

**LOGarithmic**

Sets a constant fraction of the current frequency as step width and adds it to the current frequency.

The logarithmic step width is entered in %, see [ :SOURce<hw>]:SWEep[:FREQuency]:STEP:LOGarithmic.

\*RST: LINear

**Example:** See [Example "Setup an RF frequency or power sweep"](#) on page 1288.

**Manual operation:** See ["Spacing"](#) on page 529

[ :SOURce<hw>]:SWEep:POWer:SHAPE <Shape>

[ :SOURce<hw>]:SWEep[:FREQuency]:SHAPE <Shape>

Determines the waveform shape for a frequency sweep sequence.

**Parameters:**

<Shape> SAWTooth | TRIangle

\*RST: SAWTooth

**Example:** See [Example "Setup an RF frequency or power sweep"](#) on page 1288.

**Manual operation:** See ["Shape"](#) on page 528

[ :SOURce<hw>]:SWEep:POWer:EXECute

[ :SOURce<hw>]:SWEep[:FREQuency]:EXECute

Executes an RF frequency sweep.

The command performs a single sweep and is therefore only effective in manual sweep mode.

**Example:** See [Example "Setup an RF frequency or power sweep"](#) on page 1288.

**Usage:** Event

**Manual operation:** See ["Execute Single Sweep"](#) on page 530

---

```
[:SOURce<hw>]:SWEep:POWer:RETRace <State>
```

```
[:SOURce<hw>]:SWEep[:FREQuency]:RETRace <State>
```

Activates that the signal changes to the start frequency value while it is waiting for the next trigger event.

You can enable this feature, when you are working with sawtooth shapes in sweep mode "Single" or "External Single".

**Parameters:**

```
<State>          1 | ON | 0 | OFF
                  *RST:      0
```

**Example:** See [Example "Setup an RF frequency or power sweep"](#) on page 1288.

**Manual operation:** See ["Retrace"](#) on page 528

---

```
[:SOURce<hw>]:SWEep:POWer:RUNNING?
```

```
[:SOURce<hw>]:SWEep[:FREQuency]:RUNNING?
```

Queries the current sweep state.

**Return values:**

```
<State>          1 | ON | 0 | OFF
```

**Example:** See [Example "Setup an RF frequency or power sweep"](#) on page 1288.

**Usage:** Query only

---

```
[:SOURce<hw>]:SWEep[:FREQuency]:STEP:LOGarithmic <Logarithmic>
```

Sets a logarithmically determined step width for the RF frequency sweep. The value is added at each sweep step to the current frequency.

See [Section 8.10.2.1, "Correlating parameters in sweep mode"](#), on page 519.

**Parameters:**

```
<Logarithmic>   float
                  The unit is mandatory.
                  Range:      0.01 to 100
                  Increment:  1E-3
                  *RST:      1
                  Default unit: PCT
```

**Example:** See [Example "Setup an RF frequency or power sweep"](#) on page 1288.

**Manual operation:** See ["Step Linear/Step Logarithmic"](#) on page 532

---

```
[:SOURce<hw>]:SWEep[:FREQuency]:STEP[:LINear] <Linear>
```

Sets the step width for linear sweeps.

See [Section 8.10.2.1, "Correlating parameters in sweep mode"](#), on page 519.

Omit the optional keywords so that the command is SCPI-compliant.

**Parameters:**

<Linear> float  
 Range: 0.001 Hz to (STOP - START)  
 Increment: 0.01

**Example:** See [Example "Setup an RF frequency or power sweep"](#) on page 1288.

**Manual operation:** See ["Step Linear/Step Logarithmic"](#) on page 532

**[:SOURce<hw>]:SWEep:RESet[:ALL]**

Resets all active sweeps to the starting point.

**Usage:** Event

**Manual operation:** See ["Reset Sweep"](#) on page 530

## 14.20 SYSTem subsystem

The SYSTem subsystem contains a series of commands for general functions which do not directly affect signal generation.

**Example: To check the instrument specifications**

```
// Check information on specifications document versions.
// Query all versions saved on the instrument:
:SYSTem:SPECification:VERSion:CATalog?
"04.03,04.02,04.01,04.00,03.04,03.03,03.02,03.01,03.00,02.96,02.95,02.94,
02.02,02.01,02.00,01.03,01.02,01.01,01.00"

// Query the initial version of your delivery.
:SYSTem:SPECification:VERSion:FACTory?
// Response: "04.00"

// Select a specific version:
:SYSTem:SPECification:VERSion "04.01"

// Check information of a particular specifications document.
// Query the IDs of all parameters listed in the selected version:
:SYSTem:SPECification:VERSion "04.03"
:SYSTem:SPECification:IDENTification:CATalog?
"ID_RF_FREQ_SETTING_TIME_ALC_ON_MS,ID_RF_FREQ_SETTING_TIME_MS,..."

// Query specification information on a specific parameter by its ID.
:SYSTem:SPECification? "ID_RF_FREQ_SETTING_TIME_ALC_ON_MS"
// Returns the specified value of the parameter.
```

**Example: To check network-related settings**

```
:SYSTEM:COMMunicate:NETWork:STATus?
// Response: "1"
:SYSTEM:PROTection1:STATe 0,123456

:SYSTEM:COMMunicate:NETWork:IPADdress:MODE STAT
:SYSTEM:COMMunicate:NETWork:IPADdress "10.113.0.104"
:SYSTEM:COMMunicate:NETWork:IPADdress:DNS "10.0.2.166"
:SYSTEM:COMMunicate:NETWork:COMMon:HOSTname?
// Response: "SMW200A-102030"
:SYSTEM:COMMunicate:NETWork:COMMon:WORKgroup "instrument"
:SYSTEM:COMMunicate:NETWork:COMMon:DOMain "rsint.net"
:SYSTEM:COMMunicate:NETWork:IPADdress:GATeway "10.113.0.1"
:SYSTEM:COMMunicate:NETWork:IPADdress:SUBNet:MASK "255.255.252.0"
:SYSTEM:COMMunicate:NETWork:MACaddress "08 00 27 a3 a1 70"
:SYSTEM:PROTection1:STATe 1
```

**Example: To restart the network**

```
:SYSTEM:COMMunicate:NETWork:REStart
// terminates the network connection and sets it up again
```

**Example: To find out VISA resource strings**

```
:SYSTEM:COMMunicate:NETWork:RESource?
// Response: "TCPIP::10.113.0.104::inst0::INSTR"

:SYSTEM:COMMunicate:HISLip:RESource?
// Response: "TCPIP::10.113.0.104::hislip0::INSTR"

:SYSTEM:COMMunicate:SOCKet:RESource?
// Response: "TCPIP::10.113.0.104::5025::SOCKET"

:SYSTEM:COMMunicate:USB:RESource?
// "USB::0x0AAD::0x0092::100001::INSTR"

:SYSTEM:COMMunicate:GPIB:RESource?
// Response: "GPIB::28::INSTR"
:SYSTEM:COMMunicate:GPIB:SELf:ADDress?
// Response: 28
:SYSTEM:COMMunicate:GPIB:LTERminator?
// Response: STAN

:SYSTEM:COMMunicate:SERial:RESource?
// Response: "ASRL1::INSTR"
:SYSTEM:COMMunicate:SERial:SBITS?
// Response: 1
:SYSTEM:COMMunicate:SERial:BAUD?
// Response: 115200
:SYSTEM:COMMunicate:SERial:PARity?
// Response: NONE
```



### Disabling LAN services

- ▶ **NOTICE!** Risk of loosing access over LAN. Disabling the LAN interface or the common services "LAN", "SCPI over LAN", "VNC" and "HTTP" locks the remote access to the instrument.

Use the commands in [Example "To disable the LAN interface and LAN services"](#) on page 1297 to disable or enable the LAN interface and LAN interface services individually.

- a) For the first parameter of the command, enter the security password of your instrument.

The default password is 123456.

- b) For the second parameter of the command, enter the state: 1 (ON), 0 (OFF)

### Example: To disable the LAN interface and LAN services

```
// *****
// Disable the LAN interface.
// *****
SYSTem:SECurity:NETWork:STATe "<password>", 0

// *****
// Disable the LAN services individually.
// *****
SYSTem:SECurity:NETWork:RAW:STATe "<password>", 0
// Disables remote access over raw socket.
SYSTem:SECurity:NETWork:SOE:STATe "<password>", 0
// Disables SCPI over Ethernet/LAN communication.
SYSTem:SECurity:NETWork:VNC:STATe "<password>", 0
// Disables remote access over VNC.
SYSTem:SECurity:NETWork:HTTP:STATe "<password>", 0
// Disables remote access over HTTP.
SYSTem:SECurity:NETWork:RPC:STATe "<password>", 0
// Disables remote access over remote procedure call (RPC).
SYSTem:SECurity:NETWork:SSH:STATe "<password>", 0
// Disables SSH network protocol that is used for service purposes.
SYSTem:SECurity:NETWork:FTP:STATe "<password>", 0
// Disables FTP for file transfer.
SYSTem:SECurity:NETWork:SMB:STATe "<password>", 0
// Disables shared access over SMB.
SYSTem:SECurity:NETWork:AVAHi:STATe "<password>", 0
// Disables Avahi service for automatic instrument configuration in the network.
SYSTem:SECurity:NETWork:SWUPdate:STATe "<password>", 0
// Disables software updates over LAN.
```

### Example: To use the trial license

```
// Enable the trial license, and thus all options included
:SYSTem:OPTion:TRIAL[:STATe] 1
// Query the included options
:SYSTem:OPTion:TRIAL:LIST?
"SMW-K17, SMW-K44, SMW-K61, SMW-K62, SMW-K66, SMW-K94, SMW-K107, SMW-K540, SMW-K541, SMW-K544, SMW-K810,
```

**Example: To query the error queue**

```
:SYSTem:ERRor:STATic?
// Response: -221,"Settings conflict", 153,"Input voltage out of range", ...
// Returns all static errors that are collected in the error queue.
```

```
:SYSTem:ERRor:HISTory:CLear
// Deletes the history entries.
```

**Example: To configure date and time**

```
// Query the date and time settings of the instrument.
:SYSTem:DATE?
// Response: 2023,1,16;1
:SYSTem:TIME?
// Response: 18,15,17;1
:SYSTem:TIME:ZONE?
// Response: "";1 //default UTC setting
:SYSTem:TIME:PROTOcol?
// Response: "OFF";1
// No protocol selected.
:SYSTem:NTP:STATe?
// Response: 0;1
// NTP is disabled.

// Setting the timezone and NTP time protocol
:SYSTem:TIME:ZONE:CATalog?
// Response: "UTC,leap-seconds.list,leapseconds,Africa/Abidjan,..."
:SYSTem:TIME:ZONE "Europe/Berlin"
// Set the NTP server address.
:SYSTem:NTP:HOST "timesource.net"
:SYSTem:NTP:STATe?
// Response: "1"
// The NTP time server is enabled.
```

**Commands:**

:SYSTem:ERRor:ALL?	1300
:SYSTem:ERRor:CODE:ALL?	1301
:SYSTem:ERRor:CODE[:NEXT]?	1301
:SYSTem:ERRor:COUNT?	1301
:SYSTem:ERRor[:NEXT]?	1302
:SYSTem:ERRor:GNEXt?	1302
:SYSTem:ERRor:HISTory:CLear	1303
:SYSTem:ERRor:STATic?	1303
:SYSTem:DLOCK	1303
:SYSTem:KLOCK	1303
:SYSTem:NINFormation?	1304
:SYSTem:ULOCK	1304
:SYSTem:LOCK:OWNer?	1305
:SYSTem:LOCK:RELease:ALL	1305
:SYSTem:LOCK:REQuest[:EXCLusive]?	1305

:SYSTem:SAV.....	1305
:SYSTem:RCL.....	1306
:SYSTem:PROTect<ch>[:STATe].....	1306
:SYSTem:COMMunicate:GPIB:LTERminator.....	1307
:SYSTem:COMMunicate:GPIB:RESource?.....	1307
:SYSTem:COMMunicate:GPIB[:SELF]:ADDRess.....	1307
:SYSTem:COMMunicate:HISLip:RESource?.....	1307
:SYSTem:COMMunicate:NETWork:IPADdress.....	1308
:SYSTem:COMMunicate:NETWork:IPADdress:MODE.....	1308
:SYSTem:COMMunicate:NETWork:MACAddress.....	1308
:SYSTem:COMMunicate:NETWork:RESource?.....	1308
:SYSTem:COMMunicate:NETWork:REStart.....	1309
:SYSTem:COMMunicate:NETWork:STATus?.....	1309
:SYSTem:COMMunicate:NETWork[:COMMon]:DOMain.....	1309
:SYSTem:COMMunicate:NETWork[:COMMon]:HOSTname.....	1309
:SYSTem:COMMunicate:NETWork[:COMMon]:WORKgroup.....	1310
:SYSTem:COMMunicate:NETWork[:IPADdress]:DNS.....	1310
:SYSTem:COMMunicate:NETWork[:IPADdress]:GATeway.....	1310
:SYSTem:COMMunicate:NETWork[:IPADdress]:SUBNet:MASK.....	1310
:SYSTem:COMMunicate:SERial:BAUD.....	1310
:SYSTem:COMMunicate:SERial:PARity.....	1311
:SYSTem:COMMunicate:SERial:RESource?.....	1311
:SYSTem:COMMunicate:SERial:SBITs.....	1311
:SYSTem:COMMunicate:SOCKet:RESource?.....	1311
:SYSTem:COMMunicate:USB:RESource?.....	1312
:SYSTem:HELP:EXPort.....	1312
:SYSTem:IDENtification.....	1312
:SYSTem:IDENtification:PRESet.....	1312
:SYSTem:IRESpone.....	1313
:SYSTem:ORESpone.....	1313
:SYSTem:LANGuage.....	1313
:SYSTem:INFormaTion:SCPI.....	1314
:SYSTem:SECurity:NETWork:AVAHi[:STATe].....	1314
:SYSTem:SECurity:NETWork:FTP[:STATe].....	1314
:SYSTem:SECurity:NETWork:HTTP[:STATe].....	1314
:SYSTem:SECurity:NETWork:RAW[:STATe].....	1315
:SYSTem:SECurity:NETWork:REMSupport[:STATe].....	1315
:SYSTem:SECurity:NETWork:RPC[:STATe].....	1315
:SYSTem:SECurity:NETWork:SMB[:STATe].....	1316
:SYSTem:SECurity:NETWork:SOE[:STATe].....	1316
:SYSTem:SECurity:NETWork:SSH[:STATe].....	1316
:SYSTem:SECurity:NETWork:SWUPdate[:STATe].....	1316
:SYSTem:SECurity:NETWork:VNC[:STATe].....	1317
:SYSTem:SECurity:NETWork[:STATe].....	1317
:SYSTem:SECurity:SANitize[:STATe].....	1317
:SYSTem:SECurity:VOLMode[:STATe].....	1318
:SYSTem:SPECification?.....	1318
:SYSTem:SPECification:VERSion.....	1318
:SYSTem:SPECification:IDENtification:CATalog?.....	1319
:SYSTem:SPECification:PARAmeter?.....	1319

:SYSTem:SPECification:VERsion:CATalog?	1319
:SYSTem:SPECification:VERsion:FACTory?	1320
:SYSTem:SRData?	1320
:SYSTem:STARtup:COMPLete?	1320
:SYSTem:OPTion:TRIAL:LIST?	1321
:SYSTem:OPTion:TRIAL[:STATe]	1321
:SYSTem:DATE	1321
:SYSTem:NTP:HOSTName	1321
:SYSTem:NTP:STATe	1322
:SYSTem:TIME	1322
:SYSTem:TIME:ZONE	1322
:SYSTem:TIME:ZONE:CATalog?	1322
:SYSTem:TIME:PROTOcol	1323
:SYSTem:UPTime?	1323
:SYSTem:BIOS:VERsion?	1323
:SYSTem:VERsion?	1323
:SYSTem:OSYStem?	1324
:SYSTem:MMEMOry:PATH:USER?	1324
:SYSTem:DFPRint	1324
:SYSTem:REBoot	1325
:SYSTem:REStart	1325
:SYSTem:SHUTdown	1325
:SYSTem:WAIT	1325

---

### :SYSTem:ERRor:ALL?

Queries the error/event queue for all unread items and removes them from the queue.

#### Return values:

<All> string  
 Error/event\_number,"Error/event\_description>[:Device-depend-ent info]"  
 A comma separated list of error number and a short description of the error in FIFO order.  
 If the queue is empty, the response is 0, "No error"  
 Positive error numbers are instrument-dependent. Negative error numbers are reserved by the SCPI standard.  
 Volatile errors are reported once, at the time they appear. Identical errors are reported repeatedly only if the original error has already been retrieved from (and hence not any more present in) the error queue.

#### Example:

```
SYSTem:ERRor:ALL?
// queries all entries in the error queue.
Response: 0, 'no error'
// no errors have occurred since the error queue was last read out.
```

**Usage:** Query only

**Manual operation:** See "[Clear History](#)" on page 1345

---

**:SYSTem:ERRor:CODE:ALL?**

Queries the error numbers of all entries in the error queue and then deletes them.

**Return values:**

<All> string  
Returns the error numbers. To retrieve the entire error text, send the command `:SYSTem:ERRor:ALL?`.

**0**

"No error", i.e. the error queue is empty

**Positive value**

Positive error numbers denote device-specific errors

**Negative value**

Negative error numbers denote error messages defined by SCPI.

**Example:**

```
SYSTem:ERRor:CODE:ALL?  
// queries all entries in the error queue.  
Response: 0  
// no errors have occurred since the error queue was last read out.
```

**Usage:** Query only

---

**:SYSTem:ERRor:CODE[:NEXT]?**

Queries the error number of the oldest entry in the error queue and then deletes it.

**Return values:**

<Next> string  
Returns the error number. To retrieve the entire error text, send the command `:SYSTem:ERRor:ALL?`.

**0**

"No error", i.e. the error queue is empty

**Positive value**

Positive error numbers denote device-specific errors

**Negative value**

Negative error numbers denote error messages defined by SCPI.

**Example:**

```
SYSTem:ERRor:CODE:NEXT?  
// queries the oldest entry in the error queue.  
Response: 0  
// no errors have occurred since the error queue was last read out.
```

**Usage:** Query only

---

**:SYSTem:ERRor:COUNT?**

Queries the number of entries in the error queue.

**Return values:**

<Count> integer

**0**

The error queue is empty.

**Example:**

```
SYSTem:ERRor:COUNT?
// queries the number of entries in the error queue.
Response: 1
// one error has occurred since the error queue was last read out.
```

**Usage:**

Query only

**:SYSTem:ERRor[:NEXT]?**

Queries the error/event queue for the oldest item and removes it from the queue.

**Return values:**

<Next> string

Error/event\_number,"Error/event\_description>[:Device-dependent info]"

Error number and a short description of the error.

If the queue is empty, the response is 0, "No error"

Positive error numbers are instrument-dependent. Negative error numbers are reserved by the SCPI standard.

Volatile errors are reported once, at the time they appear. Identical errors are reported repeatedly only if the original error has already been retrieved from (and hence not any more present in) the error queue.

**Example:**

```
SYSTem:ERRor:NEXT?
// queries the oldest entry in the error queue.
Response: 0, 'no error'
// no errors have occurred since the error queue was last read out.
```

**Usage:**

Query only

**Manual operation:** See "[Static Notifications/History](#)" on page 1345

**:SYSTem:ERRor:GNEXT?**

Similar to `:SYSTem:ERRor[:NEXT]?`, but queries the next entry from the global persistent error/event queue.

**Return values:**

<NextGlobalError> string

Error/event number, "Error/event description" [:Device dependent info]"

An error number and a short description of the error.

Positive error numbers are instrument-dependent. Negative error numbers are reserved by the SCPI standard.

**Example:**                `SYSTem:ERRor:GNEXt?`  
                               // queries the next error message from the global error queue.

**Usage:**                Query only

#### **:SYSTem:ERRor:HISTory:CLEar**

Clears the error history.

**Example:**                See [Example "To query the error queue"](#) on page 1298

**Usage:**                Event

**Manual operation:**    See ["Clear History"](#) on page 1345

#### **:SYSTem:ERRor:STATic?**

Returns a list of all errors existing at the time when the query is started. This list corresponds to the display on the info page under manual control.

**Return values:**

<StaticErrors>            string

**Example:**                See [Example "To query the error queue"](#) on page 1298

**Usage:**                Query only

**Manual operation:**    See ["Static Notifications/History"](#) on page 1345

#### **:SYSTem:DLOCK <DispLockStat>**

Disables the manual operation over the display, including the front panel keyboard of the instrument.

**Parameters:**

<DispLockStat>            1 | ON | 0 | OFF

\*RST:                    n.a. (factory preset: 0)

**Example:**                `SYST:DLOC ON`  
 Activates the display lock. The instrument cannot be operated via the display until it has been enabled with `SYST:DLOC OFF`.

**Manual operation:**    See ["User Interface"](#) on page 798  
 See ["Enabling a locked user interface for manual operation"](#) on page 799

#### **:SYSTem:KLOCK <State>**

Disables the front panel keyboard of the instrument.

**Parameters:**

<State>                    1 | ON | 0 | OFF

\*RST:                    n.a. (factory preset: 0)

**Example:**               SYST:KLOC ON  
Locks the front panel and external controls.  
To enable the controls, send SYST:KLOC OFF.

**Manual operation:** See ["User Interface"](#) on page 798  
See ["Enabling a locked user interface for manual operation"](#)  
on page 799

### :SYSTem:NINFormation?

Queries the oldest information message ("Error History > Level > Info") in the error/event queue.

**Return values:**

<NextInfo>               string

**Example:**               :SYSTem:NINFormation?  
Queries the oldest entry in the info message queue.  
Response: 90,"Info;=== Instrument startup...  
==="  
Information message containing error number 90, that states,  
that the instrument startup is complete.

**Usage:**                 Query only

### :SYSTem:ULOCK <SecPassWord>, <Mode>

Locks or unlocks the user interface of the instrument.

**Parameters:**

<Mode>                   ENABLEd | DONLy | DISabled | TOFF | VNConly

**ENABLEd**

Unlocks the display, the touchscreen and all controls for the manual operation.

**DONLy**

Locks the touchscreen and controls for the manual operation of the instrument. The display shows the current settings.

**VNConly**

Locks the touchscreen and controls for the manual operation, and enables remote operation over VNC. The display shows the current settings.

**TOFF**

Locks the touchscreen for the manual operation of the instrument. The display shows the current settings.

**DISabled**

Locks the display, the touchscreen and all controls for the manual operation.

\*RST:                    n.a. (factory preset: ENABLEd)



**Setting parameters:**

<SecPassWord> string

**Example:**

:SYST:ULOC "<password>", DIS

Activates the user interface lock, including display and controls.

**Manual operation:**

See ["User Interface"](#) on page 798

See ["Enabling a locked user interface for manual operation"](#) on page 799

**:SYSTem:LOCK:OWNer?**

Queries the sessions that have locked the instrument currently.

If an exclusive lock is set, the query returns the owner of this exclusive lock, otherwise it returns `NONE`.

**Return values:**

<Owner> string

**Example:**

SYST:LOCK:OWN?

Returns the owner of locking.

Response: `NONE`

The instrument is not locked.

**Usage:**

Query only

**:SYSTem:LOCK:RELease:ALL**

Revokes the exclusive access to the instrument.

**Usage:**

Setting only

**:SYSTem:LOCK:REQuest[:EXCLusive]?**

Queries whether a lock for exclusive access to the instrument via ethernet exists. If successful, the query returns a 1, otherwise 0.

**Return values:**

<Success> integer

**Example:**

SYST:LOCK:REQ?

Queries the state of exclusive locking.

Response: 1

The exclusive locking is active.

**Usage:**

Query only

**:SYSTem:SAV <Pathname>**

Saves the current R&S SMW200A settings in a file. To determine the file name and storage location, enter the directory and file name with the command. According to the file type, the R&S SMW200A assigns the extension (`*.savrc1txt`) automatically.

**Setting parameters:**

<Pathname> string

**Example:**

```
SYSTem:SAV "/var/user/temp/Test"  
// saves the file "Test.savrcltxt" in the directory /var/user/temp/.
```

**Usage:**

Setting only

**:SYSTem:RCL <Pathname>**

Selects and uploads a \*.savrcltxt file with previously saved R&S SMW200A settings from the default or a specified directory.

**Setting parameters:**

<Pathname> string

**Example:**

```
SYSTem:RCL "/var/user/temp/Test"  
// loads the "Test.savrcltxt" file from the directory /var/user/temp/.
```

**Usage:**

Setting only

**:SYSTem:PROTECT<ch>[:STATe] <State>[, <Key>]**

Activates and deactivates the specified protection level.

**Suffix:**

<ch> Indicates the protection level.  
See also "[Protection](#)" on page 794

**Parameters:**

<State> 1 | ON | 0 | OFF  
\*RST: n.a. (factory preset: 1)

**Setting parameters:**

<Key> integer

The respective functions are disabled when the protection level is activated. No password is required for activation of a level. A password must be entered to deactivate the protection level. The default password for the first level is 123456. This protection level is required to unlock internal adjustments for example.

**Example:**

To activate protection level:  
SYSTem:PROTECT1:STATe 1  
Internal adjustments or hostname cannot be changed.  
To unlock protection level 1:  
SYSTem:PROTECT1:STATe 0,123456  
Internal adjustments are accessible.

**Manual operation:** See "[Protection Level/Password](#)" on page 800

---

**:SYSTem:COMMunicate:GPIB:LTERminator** <LTerminator>

Sets the terminator recognition for remote control via GPIB interface.

**Parameters:**

<LTerminator>           STANdard | EOI

**EOI**

Recognizes an LF (Line Feed) as the terminator only when it is sent with the line message EOI (End of Line). This setting is recommended particularly for binary block transmissions, as binary blocks may coincidentally contain a character with value LF (Line Feed), although it is not determined as a terminator.

**STANdard**

Recognizes an LF (Line Feed) as the terminator regardless of whether it is sent with or without EOI.

\*RST:           n.a. (factory preset: STANdard)

**Example:**           See [Example "To find out VISA resource strings"](#) on page 1296.

---

**:SYSTem:COMMunicate:GPIB:RESource?**

Queries the visa resource string for remote control via the GPIB interface.

To change the GPIB address, use the command `:SYSTem:COMMunicate:GPIB[:SELF]:ADDRESS`.

**Return values:**

<Resource>           string

**Example:**           See [Example "To find out VISA resource strings"](#) on page 1296.

**Usage:**           Query only

---

**:SYSTem:COMMunicate:GPIB[:SELF]:ADDRESS** <Address>

Sets the GPIB address.

**Parameters:**

<Address>           integer

Range:           0 to 30

\*RST:           n.a. (factory preset: 28)

**Example:**           See [Example "To find out VISA resource strings"](#) on page 1296.

**Manual operation:** See ["GPIB Channel Address"](#) on page 835

---

**:SYSTem:COMMunicate:HISLip:RESource?**

Queries the VISA resource string. This string is used for remote control of the instrument with HiSLIP protocol.

**Return values:**

<Resource> string

**Example:** See [Example "To find out VISA resource strings"](#) on page 1296.

**Usage:** Query only

**Manual operation:** See ["HISLIP"](#) on page 833  
See ["GPIB"](#) on page 834

**:SYSTem:COMMunicate:NETWork:IPAddress <IpAddress>**

Sets the IP address.

**Parameters:**

<IpAddress> string  
Range: 0.0.0.0. to ff.ff.ff.ff

**Example:** See [Example "To check network-related settings"](#) on page 1296.

**Manual operation:** See ["IP Address"](#) on page 831

**:SYSTem:COMMunicate:NETWork:IPAddress:MODE <Mode>**

Selects manual or automatic setting of the IP address.

**Parameters:**

<Mode> AUTO | STATic  
\*RST: n.a. (factory preset: AUTO)

**Example:** See [Example "To check network-related settings"](#) on page 1296.

**Manual operation:** See ["Address Mode"](#) on page 831

**:SYSTem:COMMunicate:NETWork:MACAddress <MacAddress>**

Queries the MAC address of the network adapter.

This is a password-protected function. Unlock the protection level 1 to access it.

**Parameters:**

<MacAddress> string

**Example:** See [Example "To check network-related settings"](#) on page 1296.

**Manual operation:** See ["MAC Address"](#) on page 832

**:SYSTem:COMMunicate:NETWork:RESource?**

Queries the visa resource string for Ethernet instruments.

**Return values:**

<Resource> string

**Example:** See [Example "To find out VISA resource strings"](#) on page 1296.

**Usage:** Query only  
**Manual operation:** See ["VXI11"](#) on page 833

---

**:SYSTEM:COMMunicate:NETWork:REStart**

Restarts the network.

**Example:** See [Example "To restart the network"](#) on page 1296.

**Usage:** Event

**Manual operation:** See ["Restart Network"](#) on page 830

---

**:SYSTEM:COMMunicate:NETWork:STATus?**

Queries the network configuration state.

**Return values:**

<State> 1 | ON | 0 | OFF

**Example:** See [Example "To check network-related settings"](#) on page 1296.

**Usage:** Query only

**Manual operation:** See ["Network Status"](#) on page 830

---

**:SYSTEM:COMMunicate:NETWork[:COMMON]:DOMain <Domain>**

Determines the primary suffix of the network domain.

**Parameters:**

<Domain> string

**Example:** See [Example "To check network-related settings"](#) on page 1296.

**Manual operation:** See ["DNS Suffix"](#) on page 832

---

**:SYSTEM:COMMunicate:NETWork[:COMMON]:HOSTname <Hostname>**

Sets an individual hostname for the R&S SMW200A.

**Note:** We recommend that you do not change the hostname to avoid problems with the network connection. If you change the hostname, be sure to use a unique name.

This is a password-protected function. Unlock the protection level 1 to access it.

**Parameters:**

<Hostname> string

**Example:** See [Example "To check network-related settings"](#) on page 1296.

**Manual operation:** See ["Hostname"](#) on page 831

---

**:SYSTem:COMMunicate:NETWork[:COMMON]:WORKgroup** <Workgroup>

Sets an individual workgroup name for the instrument.

**Parameters:**

<Workgroup>            string

**Example:**            See [Example "To check network-related settings"](#) on page 1296.

**Manual operation:**   See ["Workgroup"](#) on page 831

---

**:SYSTem:COMMunicate:NETWork[:IPAddress]:DNS** <DNS>

Determines or queries the network DNS server to resolve the name.

**Parameters:**

<DNS>                    string

**Example:**            See [Example "To check network-related settings"](#) on page 1296.

**Manual operation:**   See ["DNS Server"](#) on page 832

---

**:SYSTem:COMMunicate:NETWork[:IPAddress]:GATeway** <Gateway>

Sets the IP address of the default gateway.

**Parameters:**

<Gateway>                string  
Range:            0.0.0.0 to ff.ff.ff.ff

**Example:**            See [Example "To check network-related settings"](#) on page 1296.

**Manual operation:**   See ["Default Gateway"](#) on page 832

---

**:SYSTem:COMMunicate:NETWork[:IPAddress]:SUBNet:MASK** <Mask>

Sets the subnet mask.

**Parameters:**

<Mask>                    string

**Example:**            See [Example "To check network-related settings"](#) on page 1296.

**Manual operation:**   See ["Subnet Mask"](#) on page 832

---

**:SYSTem:COMMunicate:SERial:BAUD** <Baud>

Defines the baudrate for the serial remote control interface.

**Parameters:**

<Baud>                    2400 | 4800 | 9600 | 19200 | 38400 | 57600 | 115200  
\*RST:                    n.a. (factory preset: 115200)

**Example:**            See [Example "To find out VISA resource strings"](#) on page 1296.

---

**Manual operation:** See ["Baud Rate"](#) on page 835

---

**:SYSTem:COMMunicate:SERial:PARity** <Parity>

Enters the parity for the serial remote control interface.

**Parameters:**

<Parity> NONE | ODD | EVEN  
 \*RST: n.a. (factory preset: NONE)

**Example:** See [Example "To find out VISA resource strings"](#) on page 1296.

**Manual operation:** See ["Parity"](#) on page 835

---

**:SYSTem:COMMunicate:SERial:RESource?**

Queries the visa resource string for the serial remote control interface. This string is used for remote control of the instrument.

**Return values:**

<Resource> string

**Example:** See [Example "To find out VISA resource strings"](#) on page 1296.

**Usage:** Query only

**Manual operation:** See ["SERIAL"](#) on page 834

---

**:SYSTem:COMMunicate:SERial:SBITs** <SBits>

Defines the number of stop bits for the serial remote control interface.

**Parameters:**

<SBits> 1 | 2  
 \*RST: n.a. (factory preset: 1)

**Example:** See [Example "To find out VISA resource strings"](#) on page 1296.

**Manual operation:** See ["Stop Bits"](#) on page 835

---

**:SYSTem:COMMunicate:SOCKet:RESource?**

Queries the visa resource string for remote control via LAN interface, using TCP/IP socket protocol.

**Return values:**

<Resource> string

**Example:** See [Example "To find out VISA resource strings"](#) on page 1296.

**Usage:** Query only

**Manual operation:** See ["Socket"](#) on page 834

---

**:SYSTem:COMMunicate:USB:RESource?**

Queries the visa resource string for remote control via the USB interface.

**Return values:**

<Resource>            string

**Example:**            See [Example "To find out VISA resource strings"](#) on page 1296.

**Usage:**              Query only

**Manual operation:** See ["USB"](#) on page 834

---

**:SYSTem:HELP:EXPort**

Saves the online help as zip archive in the user directory.

**Example:**

```
:SYSTem:HELP:EXPort
MMEM:CDIR?
// "/var/user"
MMEM:CAT?
// .., "Log,DIR,4096", "help.tgz,BIN,69836600"
// confirms that help zip archive is saved.
```

**Usage:**              Event

**Manual operation::** "Setup > Help > Export Help to User Path"

---

**:SYSTem:IDENtification <Identification>**

Selects the mode to determine the "IDN String" and the "OPT String" for the instrument, selected with command [:SYSTem:LANGuage](#).

**Note:** While working in an emulation mode, the R&S SMW200A specific command set is disabled, that is, the SCPI command `SYST:IDEN` is discarded.

**Parameters:**

<Identification>    AUTO | USER

**AUTO**

Automatically determines the strings.

**USER**

User-defined strings can be selected.

\*RST:            n.a. (factory preset: AUTO)

**Example:**

```
SYST:IDEN AUTO
```

Automatically assigns the OPT and IDN strings according to the selected instrument language.

**Manual operation:** See ["Mode"](#) on page 837

---

**:SYSTem:IDENtification:PRESet**

Sets the \*IDN and \*OPT strings in user defined mode to default values.



**Example:**           SYST:IDEN USER  
                  SYST:IDEN:PRES

**Usage:**            Event

**Manual operation:** See "[Set to Default](#)" on page 837

### :SYSTem:IRESpOse <IdnResponse>

Defines the user defined identification string for \*IDN.

**Note:** While working in an emulation mode, the instrument's specific command set is disabled, i.e. the SCPI command SYST:IRES is discarded.

**Parameters:**

<IdnResponse>       string

**Example:**           SYST:IDEN USER  
                  // Selects a user-defined identification  
                  SYST:IRES "Test Device"  
                  // Defines identification string 'test device'  
                  \*IDN?  
                  // Response: 'test device'

**Manual operation:** See "[IDN String](#)" on page 838

### :SYSTem:ORESpOse <OResponse>

Defines the user defined response string for \*OPT.

**Note:** While working in an emulation mode, the instrument's specific command set is disabled, i.e. the SCPI command SYST:ORES is discarded.

**Parameters:**

<OResponse>         string

**Example:**           SYST:IDEN USER  
                  // Selects a user-defined identification  
                  SYST:ORES "Test Option"  
                  // Defines the OPT string 'test option'  
                  \*OPT?  
                  // Response: 'test option'

**Manual operation:** See "[OPT String](#)" on page 838

### :SYSTem:LANGUage <Language>

Sets the remote control command set.

**Parameters:**

<Language>          string

**Example:**           SYSTem:LANGUage "SCPI"  
                  // selects SCPI command set

**Manual operation:** See ["Language"](#) on page 837

---

**:SYSTem:INFormation:SCPI** <InfoString>

Inserts system information in recorded SCPI command lists, for example information on a missing command.

**Parameters:**

<InfoString>            string

**Example:**

SYST:INF:SCPI "missing command"  
enters the information into a recorded SCPI command list.

---

**:SYSTem:SECurity:NETWork:AVAHI[:STATe]** <SecPassWord>, <AvahiState>

Disables the Avahi service for automatic configuration of the instrument in a network.

**Parameters:**

<AvahiState>            1 | ON | 0 | OFF

**Setting parameters:**

<SecPassWord>        string  
Current security password.

**Example:**

See [Example "To disable the LAN interface and LAN services"](#) on page 1297.

**Manual operation:** See ["LAN Services"](#) on page 802

---

**:SYSTem:SECurity:NETWork:FTP[:STATe]** <SecPassWord>, <FtpState>

Disables FTP protocol for file transfer between the instrument and host.

**Parameters:**

<FtpState>            1 | ON | 0 | OFF

**Setting parameters:**

<SecPassWord>        string  
Current security password.

**Example:**

See [Example "To disable the LAN interface and LAN services"](#) on page 1297.

**Manual operation:** See ["LAN Services"](#) on page 802

---

**:SYSTem:SECurity:NETWork:HTTP[:STATe]** <SecPassWord>, <HttpState>

Disables control of the instrument over HTTP, the protocol for hypermedia information systems.

**Parameters:**

<HttpState>            1 | ON | 0 | OFF

**Setting parameters:**

<SecPassWord> string  
Current security password.

**Example:** See [Example "To disable the LAN interface and LAN services"](#) on page 1297.

**Manual operation:** See ["LAN Services"](#) on page 802

**:SYSTem:SECurity:NETWork:RAW[:STATe]** <SecPassWord>, <RawState>

Disables the LAN interface for remote control of the instrument over raw socket port.

**Parameters:**

<RawState> 1 | ON | 0 | OFF

**Setting parameters:**

<SecPassWord> string  
Current security password.

**Example:** See [Example "To disable the LAN interface and LAN services"](#) on page 1297.

**:SYSTem:SECurity:NETWork:REMSupport[:STATe]** <NetRemSupport>

Disables communication over SSH (SCP) for service purposes.

**Parameters:**

<NetRemSupport> 1 | ON | 0 | OFF  
\*RST: n.a. (factory preset: 1)

**Example:** See [Example "To disable the LAN interface and LAN services"](#) on page 1297.

**Manual operation:** See ["LAN Services"](#) on page 802

**:SYSTem:SECurity:NETWork:RPC[:STATe]** <SecPassWord>, <RpcState>

Enables the LAN interface for remote control of the instrument via remote procedure calls (RPC).

**Parameters:**

<RpcState> 1 | ON | 0 | OFF

**Setting parameters:**

<SecPassWord> string  
Current security password.

**Example:** See [Example "To disable the LAN interface and LAN services"](#) on page 1297.

---

**:SYSTem:SECurity:NETWork:SMB[:STATe]** <SecPassWord>, <SmbState>

Disables access to the file system, printers and serial ports in a network over SMB.

**Parameters:**

<SmbState> 1 | ON | 0 | OFF

**Setting parameters:**

<SecPassWord> string  
Current security password.

**Example:** See [Example "To disable the LAN interface and LAN services"](#) on page 1297.

**Manual operation:** See ["LAN Services"](#) on page 802

---

**:SYSTem:SECurity:NETWork:SOE[:STATe]** <SecPassWord>, <SoeState>

Disables control of the instrument over LAN using SCPI commands.

**Parameters:**

<SoeState> 1 | ON | 0 | OFF

**Setting parameters:**

<SecPassWord> string  
Current security password.

**Example:** See [Example "To disable the LAN interface and LAN services"](#) on page 1297.

**Manual operation:** See ["LAN Services"](#) on page 802

---

**:SYSTem:SECurity:NETWork:SSH[:STATe]** <SecPassWord>, <SshState>

Disables control of the instrument over LAN using the SSH network protocol.

**Parameters:**

<SshState> 1 | ON | 0 | OFF

**Setting parameters:**

<SecPassWord> string  
Current security password.

**Example:** See [Example "To disable the LAN interface and LAN services"](#) on page 1297.

**Manual operation:** See ["LAN Services"](#) on page 802

---

**:SYSTem:SECurity:NETWork:SWUPdate[:STATe]** <SecPassWord>,  
<SwUpdateState>

Disables software update over LAN.

**Parameters:**

<SwUpdateState> 1 | ON | 0 | OFF

**Setting parameters:**

<SecPassWord> string  
Current security password.

**Example:** See [Example "To disable the LAN interface and LAN services"](#) on page 1297.

**Manual operation:** See ["LAN Services"](#) on page 802

**:SYSTem:SECurity:NETWork:VNC[::STATe]** <SecPassWord>, <VncState>

Disables the VNC interface for remote control of the instrument.

**Parameters:**

<VncState> 1 | ON | 0 | OFF

**Setting parameters:**

<SecPassWord> string  
Current security password.

**Example:** See [Example "To disable the LAN interface and LAN services"](#) on page 1297.

**Manual operation:** See ["LAN Services"](#) on page 802

**:SYSTem:SECurity:NETWork[::STATe]** <SecPassWord>, <LanStorState>

Disables the LAN interface in general, including all services.

**Parameters:**

<LanStorState> 1 | ON | 0 | OFF

**Setting parameters:**

<SecPassWord> string  
Current security password.  
The default password is 123456.

**Example:** See [Example "To disable the LAN interface and LAN services"](#) on page 1297

**Manual operation:** See ["LAN"](#) on page 802

**:SYSTem:SECurity:SANitize[::STATe]** <SecPassWord>, <MmemProtState>

Sanitizes the internal memory.

**Parameters:**

<MmemProtState> 0 | 1 | OFF | ON  
\*RST: 0

**Setting parameters:**

<SecPassWord> string

**Example:**

SYSTem:SECurity:SANitize[:STATE] 1

**Manual operation:** See ["Sanitize"](#) on page 797

**:SYSTem:SECurity:VOLMode[:STATE] <SecPassWord>, <MmemProtState>**

Activates volatile mode, so that no user data can be written to the internal memory permanently.

To enable volatile mode, reboot the instrument. Otherwise the change has no effect.

**Parameters:**

<MmemProtState> 0 | 1 | OFF | ON

\*RST: 0

**Setting parameters:**

<SecPassWord> string

Current security password

The default password is 123456.

**Example:**

SYSTem:SECurity:VOLMode:STATE "123456", 1  
SYSTem:REBoot

**Manual operation:** See ["Volatile Mode"](#) on page 796

**:SYSTem:SPECification? <Id>**

Retrieves data sheet information for a specific parameter.

**Setting parameters:**

<Id> string

Identifies the name of the entry in the data sheet, as queried with the command [:SYSTem:SPECification:IDENTification:CATalog?](#) on page 1319

**Return values:**

<ValList> float

Comma-separated list with the specified and, if available, the typical value of the parameter, as specified in the data sheet. See also [Section 13.7.4, "Datasheet"](#), on page 859.

**Example:**

See [Example "To check the instrument specifications"](#) on page 1295.

**Usage:**

Query only

**:SYSTem:SPECification:VERSion <Version>**

Selects a data sheet version from the data sheets saved on the instrument.

Further queries regarding the data sheet parameters (<Id>) and their values refer to the selected data sheet.

To query the list of data sheet versions, use the command `:SYSTem:SPECification:VERSion:CATalog?` on page 1319.

**Parameters:**

<Version> string

**Example:** See `:SYSTem:SPECification?` on page 1318.

**:SYSTem:SPECification:IDENTification:CATalog?**

Queries the parameter identifiers (<Id>) available in the data sheet.

**Return values:**

<IdList> string  
Comma-separated string of the parameter identifiers (<Id>)

**Example:** See `:SYSTem:SPECification?` on page 1318.

**Usage:** Query only

**:SYSTem:SPECification:PARAmeter? <Id>[, <Parameter>]**

Retrieves data sheet information for a specific parameter.

**Setting parameters:**

<Id> string  
Identifies the name of the entry in the data sheet.  
Query the data sheet parameters with the command `:SYSTem:SPECification:IDENTification:CATalog?`.

<Parameter> float  
An additional value the result (ValList) depends on.

**Return values:**

<ValList> float  
Comma-separated list with the specified and, if available, the typical value of the parameter, as specified in the data sheet.

**Example:** **Note:** The following values are merely an example. Your instrument may not support the same parameters.  
`SYST:SPEC:PAR? "ID_RF_FREQ_SETTING_TIME_MS", 0.1`  
`SYST:SPEC:PAR? "ID_RF_LEVEL_MAX_GENERAL_DBM", 0.1`

**Usage:** Query only

**:SYSTem:SPECification:VERSion:CATalog?**

Queries all data sheet versions stored in the instrument.

**Return values:**

<VersCatalog> string

**Example:**

See [:SYSTem:SPECification?](#) on page 1318.

**Usage:**

Query only

---

**:SYSTem:SPECification:VERSion:FACTory?**

Queries the data sheet version of the factory setting.

**Return values:**

<Version> string

**Example:**

See [:SYSTem:SPECification?](#) on page 1318.

**Usage:**

Query only

**Manual operation:** See ["Versions"](#) on page 1352

---

**:SYSTem:SRData?**

Queries the SCPI recording data from the internal file.

This feature enables you to transfer an instrument configuration to other test environments, as e.g. laboratory virtual instruments.

**Return values:**

<FileData> block data

**Example:**

```
SYSTem:SRData?
// #3118:SOURce1:ROSCillator:SOURce EXT
// :SOURce1:FREQuency:CW 4000000000
// :SOURce1:FREQuency:OFFSet 1000000
// :SOURce1:AM1:STATe 1
// :OUTPut1:STATe 1
```

**Usage:**

Query only

---

**:SYSTem:STARtup:COMplete?**

Queries if the startup of the instrument is completed.

**Return values:**

<Complete> 1 | ON | 0 | OFF  
\*RST: 0

**Example:**

```
SYSTem:STARtup:COMplete?
Response: 1
// the instrument has started and is ready for operation.
```

**Usage:**

Query only

---



---

**:SYSTem:OPTion:TRial:LIST?**

Queries the options included in the trial license. For a list of all available options and their description, refer to the data sheet.

**Return values:**

<TrialOptList>            string

**Example:**                see [Example "To use the trial license"](#) on page 1297

**Usage:**                    Query only

**Manual operation:**    See ["Trial License Table"](#) on page 778

---

**:SYSTem:OPTion:TRial[:STATe] <TrialOptState>**

Activates the trial license.

**Parameters:**

<TrialOptState>            1 | ON | 0 | OFF

\*RST:                    n.a. (factory preset: 0)

**Example:**                see [Example "To use the trial license"](#) on page 1297

**Manual operation:**    See ["Trial Period"](#) on page 778

---

**:SYSTem:DATE <Year>, <Month>, <Day>**

Queries or sets the date for the instrument-internal calendar.

This is a password-protected function. Unlock the protection level 1 to access it.

**Parameters:**

<Year>                    integer

<Month>                   integer

Range:                    1 to 12

<Day>                     integer

Range:                    1 to 31

**Example:**                See [Example "To configure date and time"](#) on page 1298.

**Manual operation:**    See ["Date"](#) on page 1359

---

**:SYSTem:NTP:HOSTname <NTPName>**

Sets the address of the NTP server. You can enter the IP address, or the hostname of the time server, or even set up an own vendor zone. See the Internet for more information on NTP.

**Parameters:**

<NTPName>                string

**Manual operation:**    See ["NTP Address"](#) on page 1359

---

**:SYSTem:NTP:STATe** <UseNtpState>

Activates clock synchronization via NTP.

**Parameters:**

<UseNtpState> 1 | ON | 0 | OFF  
 \*RST: n.a. (factory preset: 0)

**Example:** See [Example "To configure date and time"](#) on page 1298.

**Manual operation:** See ["NTP Address"](#) on page 1359

---

**:SYSTem:TIME** <Hour>, <Minute>, <Second>

Queries or sets the time for the instrument-internal clock.

This is a password-protected function. Unlock the protection level 1 to access it.

**Parameters:**

<Hour> integer  
 Range: 0 to 23  
 <Minute> integer  
 Range: 0 to 59  
 <Second> integer  
 Range: 0 to 59

**Example:** See [Example "To configure date and time"](#) on page 1298.

**Manual operation:** See ["Time"](#) on page 1359

---

**:SYSTem:TIME:ZONE** <TimeZone>

Sets the timezone. You can query the list of the available timezones with `:SYSTem:TIME:ZONE:CATalog?`.

**Parameters:**

<TimeZone> string

**Example:** See [Example "To configure date and time"](#) on page 1298.

**Manual operation:** See ["Timezone"](#) on page 1359

---

**:SYSTem:TIME:ZONE:CATalog?**

Queries the list of available timezones.

**Return values:**

<Catalog>

**Example:** See [Example "To configure date and time"](#) on page 1298.

**Usage:** Query only

**Manual operation:** See ["Timezone"](#) on page 1359

---

**:SYSTem:TIME:PROTocol** <TimeProtocol>

Sets the date and time of the operating system.

**Parameters:**

<TimeProtocol> OFF | NONE | 0 | NTP | ON | 1

**NONE**

Sets the date and time according to the selected timezone, see [:SYSTem:TIME:ZONE:CATalog?](#) on page 1322 and [:SYSTem:TIME:ZONE](#) on page 1322.

**NTP**

Sets the date and time derived from the network time protocol. To select the NTP time server, use the commands [:SYSTem:NTP:HOSTname](#) on page 1321 and [:SYSTem:NTP:STATe](#) on page 1322.

\*RST: n.a. (factory preset: NONE)

**Example:** See [Example "To configure date and time"](#) on page 1298.

**Manual operation:** See ["Time Protocol"](#) on page 1359

---

**:SYSTem:UPTime?**

Queries the up time of the operating system.

**Return values:**

<UpTime> "<ddd.hh:mm:ss>"

**Example:**

SYSTem:UPTime?  
Response: "0.08:11:00"

**Usage:** Query only

---

**:SYSTem:BIOS:VERSion?**

Queries the BIOS version of the instrument.

**Return values:**

<Version> string

**Example:**

SYST:BIOS:VERS?  
queries the BIOS version.  
Response: 123456

**Usage:** Query only

---

**:SYSTem:VERSion?**

Queries the SCPI version the instrument's command set complies with.

**Return values:**

<Version> string

**Example:**

```

SYSTem:VERSion
// queries the SCPI version.
Response: "1996"
// the instrument complies with the SCPI version from 1996.

```

**Usage:** Query only

---

**:SYSTem:OSYSstem?**

Queries the operating system of the instrument.

**Return values:**

<OperSystem> string

**Example:**

```

SYSTem:OSYSstem?
Response: "Linux"

```

**Usage:** Query only

---

**:SYSTem:MMEMory:PATH:USER?**

Queries the user directory, that means the directory the R&S SMW200A stores user files on.

**Return values:**

<PathUser> string

**Example:**

```

SYSTem:MMEMory:PATH:USER?
Response: ""/var/user/"

```

**Usage:** Query only

---

**:SYSTem:DFPRint <Directory>**

Creates a file with the device footprint of the product.

The content is formatted in machine-readable form, suitable for automatic further processing.

The generic file name is composed of

DeviceFootprint\_<SerialNumber>\_<Date>\_<Time>.xml. R&S SMW200A saves the file in the definable directory. If the directory is not specified, it saves the footprint file in the internal default directory (/var/lib/Rohde-Schwarz/DeviceFootprint).

If you are obtaining technical support as described in [Section 15.9, "Collecting information for technical support"](#), on page 1353, this information is automatically retrieved and is part of the created \*.tar.gz support file.

You can download the file by using the SCPI commands of the MMEMory subsystem.

**Setting parameters:**

<Directory> string  
 Path to the directory for saving the device footprint file.  
 Ensure that you have the permission to write into the directory.

**Return values:**

<DeviceFootprint> string  
 Information on the product type, identification and the installed hardware, software and further service-related information on the product's configuration.

**Example:**

```
SYSTem:DFPrint "/var/user/devicefootprint"

SYSTem:DFPrint?
// MMEM:DATA?
// returns the device footprint information saved with SYST:DFPrint
```

**:SYSTem:REBoot**

Reboots the instrument including the operating system.

**Usage:** Event

**:SYSTem:REStart**

Restarts the instrument without restarting the operating system.

**Usage:** Event

**:SYSTem:SHUTdown**

Shuts down the instrument.

**Usage:** Event

**:SYSTem:WAIT <TimeMs>**

Delays the execution of the subsequent remote command by the specified time.

This function is useful, for example to execute an SCPI sequence automatically but with a defined time delay between some commands.

See [Section 12.4.2, "How to assign actions to the \[USER\] key"](#), on page 767.

**Setting parameters:**

<TimeMs> integer  
 Wait time in ms  
 Range: 0 to 10000  
 \*RST: 0

**Example:**

```

SYSTEM:WAIT 10000
// Waits 10s before resetting the instrument.
*RST

```

**Usage:** Setting only

## 14.21 STATus subsystem

This system contains the commands for the status reporting system. See also [Section 13.4, "Status reporting system"](#), on page 826 for detailed information.

\*RST on page 901 has no effect on the status registers.

### Value ranges

- Queries return the current value of the respective register, which permits a check of the device status.  
Return values: A decimal value in the range 0 to 32767 ( $=2^{15}-1$ )
- The configuration commands set the respective register thus determining which status changes of the R&S SMW200A cause the status registers to be changed.  
Setting values: A decimal value in the range 0 to 32767 ( $=2^{15}-1$ )

:STATus:OPERation:CONDition?	1326
:STATus:OPERation:ENABle	1327
:STATus:OPERation[:EVENT]	1327
:STATus:OPERation:NTRansition	1327
:STATus:OPERation:PTRansition	1327
:STATus:PRESet	1328
:STATus:QUESTionable:CONDition	1328
:STATus:QUESTionable:ENABle	1328
:STATus:QUESTionable[:EVENT]	1328
:STATus:QUESTionable:NTRansition	1329
:STATus:QUESTionable:PTRansition	1329
:STATus:QUEue[:NEXT]?	1329

---

### :STATus:OPERation:CONDition?

Queries the content of the CONDition part of the STATus:OPERation register.

This part contains information on the action currently being performed in the instrument. The content is not deleted after being read out because it indicates the current hardware status.

#### Return values:

<Condition> string

**Example:** :STATus:OPERation:CONDition?

**Usage:** Query only

---

**:STATus:OPERation:ENABle** <Enable>

Sets the bits of the ENABle part of the STATus:OPERation register. This setting determines which events of the Status-Event part are forwarded to the sum bit in the status byte. These events can be used for a service request.

**Parameters:**

<Enable>                    string

**Example:**

`:STAT:OPER:ENAB 32767`

all events are forwarded to the sum bit of the status byte.

---

**:STATus:OPERation[:EVENT]** < >

Queries the content of the EVENT part of the STATus:OPERation register. This part contains information on the actions performed in the instrument since the last readout. The content of the EVENT part is deleted after being read out.

**Parameters:**

< >                            string

**Example:**

`:STAT:OPER:EVEN?`

queries the STATus:OPERation:EVENT register.

---

**:STATus:OPERation:NTRansition** <Ntransition>

Sets the bits of the NTRansition part of the STATus:OPERation register. If a bit is set, a transition from 1 to 0 in the condition part causes an entry to be made in the EVENT part of the register. The disappearance of an event in the hardware is thus registered, for example the end of an adjustment.

**Parameters:**

<Ntransition>                string

**Example:**

`:STAT:OPER:NTR 0`

a transition from 1 to 0 in the condition part of the Status:Operation register does not cause an entry to be made in the EVENT part.

---

**:STATus:OPERation:PTRansition** <Ptransition>

Sets the bits of the PTRansition part of the STATus:OPERation register. If a bit is set, a transition from 0 to 1 in the condition part causes an entry to be made in the EVENT part of the register. A new event in the hardware is thus registered, for example the start of an adjustment.

**Parameters:**

<Ptransition>                string

**Example:**

`:STAT:OPER:PTR 32767`

all transitions from 0 to 1 in the condition part of the Status:Operation register cause an entry to be made in the EVENT part.

---

---

**:STATus:PRESet** <Preset>

Resets the status registers. All PTRansition parts are set to FFFFh (32767), i.e. all transitions from 0 to 1 are detected. All NTRansition parts are set to 0, i.e. a transition from 1 to 0 in a CONDition bit is not detected. The ENABLE parts of STATus:OPERation and STATus:QUEStionable are set to 0, i.e. all events in these registers are not passed on.

**Parameters:**

<Preset>                      string

**Example:**

STAT:PRESet  
resets the status registers.

---

**:STATus:QUEStionable:CONDition** <Condition>

Queries the content of the CONDition part of the STATus:QUEStionable register. This part contains information on the action currently being performed in the instrument. The content is not deleted after being read out since it indicates the current hardware status.

**Parameters:**

<Condition>                      string

**Example:**

:STATus:QUEStionable:CONDition?  
queries the Status:Questionable:Condition register.

---

**:STATus:QUEStionable:ENABLE** <Enable>

Sets the bits of the ENABLE part of the STATus:QUEStionable register. The enable part determines which events of the STATus:EVENT part are enabled for the summary bit in the status byte. These events can be used for a service request.

If a bit in the ENABLE part is 1, and the corresponding EVENT bit is true, a positive transition occurs in the summary bit. This transition is reported to the next higher level.

**Parameters:**

<Enable>                          string

**Example:**

STAT:QUES:ENAB 1  
Problems when performing an adjustment cause an entry to be made in the sum bit.

---

**:STATus:QUEStionable[:EVENT]** < >

Queries the content of the EVENT part of the STATus:QUEStionable register. This part contains information on the actions performed in the instrument since the last readout. The content of the EVENT part is deleted after being read out.

**Parameters:**

< >                                  string



**Example:**                    STAT:QUES:EVEN?  
queries the Status:Questionable:Event register.

#### :STATus:QUESTionable:NTRansition <Ntransition>

Sets the bits of the NTRansition part of the STATus:QUESTionable register. If a bit is set, a transition from 1 to 0 in the condition part causes an entry to be made in the EVENT part of the register.

**Parameters:**

<Ntransition>                string

**Example:**                    STAT:QUES:NTR 0  
a transition from 1 to 0 in the condition part of the STATus:QUESTionable register does not cause an entry to be made in the EVENT part

#### :STATus:QUESTionable:PTRansition <PTransition>

Sets the bits of the PTRansition part of the STATus:QUESTionable register. If a bit is set, a transition from 1 to 0 in the condition part causes an entry to be made in the EVENT part of the register.

**Parameters:**

<PTransition>                string

**Example:**                    STAT:QUES:PTR 32767  
all transitions from 0 to 1 in the condition part of the STATus:QUESTionable register cause an entry to be made in the EVENT part

#### :STATus:QUEue[:NEXT]?

Queries the oldest entry in the error queue and then deletes it. Positive error numbers denote device-specific errors, and negative error numbers denote error messages defined by SCPI. If the error queue is empty, 0 ("No error") is returned.

The command is identical to :SYSTem:ERRor[:NEXT]? on page 1302.

**Return values:**

<Next>                        string

**Example:**                    :STATus:QUEue?  
queries the oldest entry in the error queue.  
Response: 0, 'no error'  
no errors have occurred since the error queue was last read out

**Usage:**                      Query only

## 14.22 TEST subsystem

The TEST subsystem contains the commands for performing test routines directly at the hardware assemblies.

The selftest responses with a 0 if the test is performed successfully, otherwise a value other than 0 is returned. None of the commands of this system has a \*RST value.

### Example: Testing the screen display

```
// show the check screen
:TEST:PIXel:WINDow 1
// select the color for the display, e.g. blue
TEST:PIXel:COLor BLUE
// select the sequence for changing the color automatically
TEST:PIXel:COLor AUTO //(~3s per color)
// select a specific RGB color, e.g. black
TEST:PIXel:RGBA 0,0,0,255
// turn on the gradient
TEST:PIXel:GRADient 1
// switch to text mode
:TEST:PIXel:TEXT 1
// set the point size of the text
:TEST:PIXel:POINTsize 600
// exit the check screen
:TEST:PIXel:WINDow 0
```

:TEST:BASEband?	1331
:TEST:BASEband:LOG?	1331
:TEST:BB:BNC:CONNECTION?	1331
:TEST:BB:BNC:DESTINATION?	1331
:TEST:BB:BNC:LOG?	1332
:TEST:BB:BNC:SOURce	1332
:TEST:BB:GENerator:ARbitrary	1333
:TEST:BB:GENerator:FREQUENCY<ch>	1333
:TEST:BB:GENerator:GAIN	1333
:TEST:BB:GENerator:SOURce	1333
:TEST:BB:GENerator:STATE	1334
:TEST<hw>:DIRect:BLOCK:READ?	1334
:TEST<hw>:DIRect:BLOCK:WRITe	1334
:TEST<hw>:ALL:START	1335
:TEST<hw>:ALL:RESult?	1335
:TEST:PIXel:COLor	1335
:TEST:PIXel:GRADient	1335
:TEST:PIXel:POINTsize	1336
:TEST:PIXel:RGBA	1336
:TEST:PIXel:TEXT	1336
:TEST:PIXel:WINDow	1336

---

**:TEST:BASEband?**

Queries the result of the baseband selftest.

**Return values:**

<TestBbError> 0 | 1 | RUNning | STOPped

**Example:**

```
:TEST:BASEband?
// 0
// the test succeeded
```

**Usage:** Query only

**Manual operation:** See "[Execute Baseband Selftest](#)" on page 1374

---

**:TEST:BASEband:LOG?**

Queries the log message reported during the baseband test.

This is a password-protected function. Unlock the protection level 1 to access it.

**Return values:**

<TestBasebandLog> string

**Example:**

```
SYSTem:PROTect1 0,123456
TEST:BB:BASEband:LOG?
// queries the reported message
```

**Usage:** Query only

**Manual operation:** See "[Log Message](#)" on page 1374

---

**:TEST:BB:BNC:CONNECTION?**

Queries the BNC connection test result.

This is a password-protected function. Unlock the protection level 1 to access it.

**Return values:**

<TestStatus> 0 | 1 | RUNning | STOPped

**Example:**

```
SYSTem:PROTect1 0,123456
TEST:BB:BNC:CONNECTION?
// RUN
// test is running
```

**Usage:** Query only

**Manual operation:** See "[Execute BNC Connection Test](#)" on page 1374

---

**:TEST:BB:BNC:DESTination <BncDestination>**

Selects the BNC connection test destination.

This is a password-protected function. Unlock the protection level 1 to access it.

**Parameters:**

<BncDestination> AUTO | USER1 | USER2 | USER3 | USER4 | USER5 | USER6 |  
 TRGA | TRGB | C1TMC1 | C1TM2 | C1TM3 | C2TMC4 |  
 C2TM5 | C2TM6 | F1TMC1 | F1TM2 | F1TM3 | F2TMC4 |  
 F2TM5 | F2TM6 | F3TMC1 | F3TM2 | F3TM3 | F4TMC4 |  
 F4TM5 | F4TM6  
 \*RST: USER2

**Example:**

```
SYSTem:PROTect1 0,123456
TEST:BB:BNC:DESTination TRGA
// tests the instrument trigger connector of path A
```

**Manual operation:** See "[Destination](#)" on page 1374

**:TEST:BB:BNC:LOG?**

Queries the log message reported during the BNC connector test.

This is a password-protected function. Unlock the protection level 1 to access it.

**Return values:**

<Log> string

**Example:**

```
SYSTem:PROTect1 0,123456
TEST:BB:BNC:LOG?
// queries the reported message
```

**Usage:** Query only

**Manual operation:** See "[Log Message](#)" on page 1374

**:TEST:BB:BNC:SOURce <BncSource>**

Selects the BNC connection test source.

This is a password-protected function. Unlock the protection level 1 to access it.

**Parameters:**

<BncSource> AUTO | USER1 | USER2 | USER3 | USER4 | USER5 | USER6 |  
 TRGA | TRGB | C1TMC1 | C1TM2 | C1TM3 | C2TMC4 |  
 C2TM5 | C2TM6 | F1TMC1 | F1TM2 | F1TM3 | F2TMC4 |  
 F2TM5 | F2TM6 | F3TMC1 | F3TM2 | F3TM3 | F4TMC4 |  
 F4TM5 | F4TM6  
 \*RST: USER1

**Example:**

```
SYSTem:PROTect1 0,123456
TEST:BB:BNC:SOURce AUTO
// detects the connectors at that signal is assigned
// and performs the connecton test
```

**Manual operation:** See "[Source](#)" on page 1373

---

**:TEST:BB:GENerator:ARBitrary <Filename>**

Selects the ARB waveform to be tested.

**Parameters:**

<Filename>                    string

**Example:**

```
TEST:BB:GENerator:ARBitrary "3gpp.wv"
// Tests the loaded waveform, generating a 3GPP signal
```

**Manual operation:** See "[Select ARB File](#)" on page 1376

---

**:TEST:BB:GENerator:FREQuency<ch> <Frequency>**

Sets the frequency of the test sine or constant I/Q test signal.

**Parameters:**

<Frequency>                    float  
Range:                    -250E6 to 250E6  
Increment:                1E-3  
\*RST:                    1E6

**Example:**

```
TEST:BB:GENerator:FREQuency 50 MHz
```

**Manual operation:** See "[Frequency](#)" on page 1376

---

**:TEST:BB:GENerator:GAIN <Gain>**

Sets the gain for a sine or constant I/Q test signal.

**Parameters:**

<Gain>                        float  
Range:                    -1 to 1  
Increment:                1E-6  
\*RST:                    1

**Example:**

```
TEST:BB:GENerator:GAIN 0.5
// amplifies the test signal by a factor of 0.5
```

**Manual operation:** See "[Gain](#)" on page 1376

---

**:TEST:BB:GENerator:SOURce <lqSource>**

Selects the test signal source.

**Parameters:**

<lqSource>                    SINE | CONStant | ARB | TTONE

**SINE**

Generates a sine waveform. To determine the frequency, use command `:TEST:BB:GENerator:FREQuency<ch>` on page 1333.

**CONStant**

Uses a constant I/Q test signal.

**ARB**

Selects a signal generated generated by the ARB.

```
*RST: SINE
```

**Example:** `:TEST:BB:GENerator:SOURce SINE`

**Manual operation:** See "[IQ Source](#)" on page 1375

**:TEST:BB:GENerator:STATe <State>**

Starts the test generator.

**Parameters:**

<State> 1 | ON | 0 | OFF

```
*RST: 0
```

**Example:** `TEST:BB:GENerator:STATe ON`  
*// activates the test generator*

**Manual operation:** See "[State](#)" on page 1375

**:TEST<hw>:DIRect:BLOCK:READ? <Board>, <SubAddr>, <Addr>[, <Len>]**

Direct mode for querying the blocks of the hardware assemblies directly.

The respective hardware assembly responds directly to the command; any safety mechanisms are bypassed. This function is only available via remote control.

**Query parameters:**

<Board> string

<SubAddr> integer

<Addr> integer

<Len> integer

**Return values:**

<DataBlock> string

**Example:** `TEST:DIR:BLOCK:READ? 'TEST_SCPI',0,0,8`

**Usage:** Query only

**:TEST<hw>:DIRect:BLOCK:WRITe <BoardName>, <SubAddress>, <StartAddress>, <DataBlock>**

Direct mode for programming the blocks of the hardware assemblies directly.

The respective hardware assembly responds directly to the command; any safety mechanisms are bypassed. This function is only available via remote control.

**Setting parameters:**

<BoardName> string  
 <Board>, <SubAddr>, <Addr>, <Data>

<SubAddress> integer

<StartAddress> integer

<DataBlock> string

**Example:** TEST:DIR:BLOC:WRIT 'TEST\_SCPI',0,0,#1812345678

**Usage:** Setting only

---

**:TEST<hw>:ALL:START**

**Usage:** Event

Starts the selftest. Use the command `:TEST<hw>:ALL:RESult?` to query the result.

---

**:TEST<hw>:ALL:RESult?**

Queries the result of the performed selftest. Start the selftest with `:TEST<hw>:ALL:START`.

**Return values:**

<Result> 0 | 1 | RUNning | STOPped  
 \*RST: STOPped

**Usage:** Query only

---

**:TEST:PIXel:COLor <PixTestColor>**

Selects the color of the screen.

"AUTO" switches from one color to the next in time intervals of approximately 3 s per color.

**Setting parameters:**

<PixTestColor> RED | BLUE | WHITe | GREen | AUTO | GR25 | GR50 | GR75 | BLACK  
 \*RST: RED

**Example:** See [Example "Testing the screen display"](#) on page 1330.

**Usage:** Setting only

**Manual operation:** See ["Check Display Screen"](#) on page 1367

---

**:TEST:PIXel:GRADient <PixTestGradStat>**

Activates the gradient for display screen test.

**Parameters:**

<PixTestGradStat> 1 | ON | 0 | OFF  
 \*RST: 0

**Example:** See [Example "Testing the screen display"](#) on page 1330.

**Manual operation:** See ["Check Display Screen"](#) on page 1367

**:TEST:PIXel:POINTsize** <PixTestGradStat>

Sets the point size of the test text.

**Parameters:**

<PixTestGradStat> integer  
 Range: 0 to 999  
 \*RST: n.a. (no preset. default: 0)

**Example:** See [Example "Testing the screen display"](#) on page 1330.

**Manual operation:** See ["Check Display Screen"](#) on page 1367

**:TEST:PIXel:RGBA**

Sets a specific RGBA color for the screen.

**Example:** See [Example "Testing the screen display"](#) on page 1330.

**Manual operation:** See ["Check Display Screen"](#) on page 1367

**:TEST:PIXel:TEXT** <PixTestGradStat>

Activats the test text mode.

**Parameters:**

<PixTestGradStat> 1 | ON | 0 | OFF  
 \*RST: 0

**Example:** See [Example "Testing the screen display"](#) on page 1330.

**Manual operation:** See ["Check Display Screen"](#) on page 1367

**:TEST:PIXel:WINDow** <PixTestWindow>

Activates the check display screen.

**Setting parameters:**

<PixTestWindow> 1 | ON | 0 | OFF  
 \*RST: 0

**Example:** See [Example "Testing the screen display"](#) on page 1330.

**Usage:** Setting only

**Manual operation:** See ["Check Display Screen"](#) on page 1367



## 14.23 TRIGger subsystem

The TRIGger system contains the commands for selecting the trigger source for the RF and LF sweep.

You can work with an internal or with an externally applied trigger signal. In this case, use the commands in the SOURce:INPut subsystem to configure the signal.

The trigger system of the R&S SMW200A is a simplified implementation of the SCPI trigger system. The TRIGger system differs from the SCPI system as follows:

- No INITiate command; the instrument behaves as if INITiate:CONTinuous ON were set.
- Under TRIGger several sweep subsystems exist.
- The trigger source names correspond directly to the various settings of manual control. SCPI uses different names which are also accepted by the instrument. The SCPI names should be used if compatibility is an important consideration.

In addition to these commands, see more trigger-related commands in the modulation and RF signal subsystems.

*Table 14-11: Cross-reference between the manual and remote control*

R&S proprietary value name	SCPI conform value name	Parameter in manual control
AUTO	IMMediate	"Auto" mode
SINGle	BUS	"Single" mode.
EXTernal	EXTernal	"Ext Single" and "Ext Step" mode. Use command LFO:SWEep:MODE to select between the two sweep modes.
EAuto	-	"Ext Start/Stop" mode.

:TRIGger<hw>:FSweep:SOURce.....	1337
:TRIGger<hw>:LFFSweep:SOURce.....	1337
:TRIGger<hw>:PSweep:SOURce.....	1337
:TRIGger<hw>[:SWEep]:SOURce.....	1337
:TRIGger<hw>:FSweep[:IMMediate].....	1338
:TRIGger<hw>:LFFSweep[:IMMediate].....	1338
:TRIGger<hw>:PSweep[:IMMediate].....	1339
:TRIGger<hw>[:SWEep][:IMMediate].....	1339
:TRIGger<hw>:LFFSweep.....	1339

```

:TRIGger<hw>:FSweep:SOURce <Source>
:TRIGger<hw>:LFFSweep:SOURce <Source>
:TRIGger<hw>:PSweep:SOURce <Source>
:TRIGger<hw>[:SWEep]:SOURce <Source>

```

Selects the trigger source for the corresponding sweeps:

- FSweep - RF frequency
- LFFSweep - LF frequency

- PSweep - RF level
- SWEEP - all sweeps

The source names of the parameters correspond to the values provided in manual control of the instrument. They differ from the SCPI-compliant names, but the instrument accepts both variants.

Use the SCPI name, if compatibility is an important issue. Find the corresponding SCPI-compliant commands in [Cross-reference between the manual and remote control](#).

#### Setting parameters:

<Source>                    AUTO | IMMEDIATE | SINGLE | BUS | EXTERNAL | EAUTO

**AUTO [IMMEDIATE]**  
Executes a sweep automatically.  
In this free-running mode, the trigger condition is met continuously. I.e. when a sweep is completed, the next one starts immediately.

**SINGLE [BUS]**  
Executes one complete sweep cycle.  
The following commands initiate a trigger event:  
\*TRG on page 902  
[:SOURCE<hw>]:SWEep:POWer:EXECute  
[:SOURCE<hw>]:SWEep[:FREQuency]:EXECute  
:TRIGger<hw>[:SWEep][:IMMEDIATE], :TRIGger<hw>:  
PSweep[:IMMEDIATE] and :TRIGger<hw>:FSWEEP[:  
IMMEDIATE].  
Set the sweep mode with the commands:  
[:SOURCE<hw>]:SWEep:POWer:MODEAUTO|STEP  
[:SOURCE<hw>]:SWEep[:FREQuency]:MODEAUTO|STEP  
[:SOURCE<hw>]:LFOutput:SWEep[:FREQuency]:MODE  
AUTO|STEP  
In step mode (STEP), the instrument executes only one step.

**EXTERNAL**  
An external signal triggers the sweep.

**EAUTO**  
An external signal triggers the sweep. When one sweep is finished, the next sweep starts.  
A second trigger event stops the sweep at the current frequency, a third trigger event starts the trigger at the start frequency, and so on.

\*RST:                    AUTO

**Example:**                    See [Example "Setup an LF sweep"](#) on page 1227

**Usage:**                    Setting only

---

```
:TRIGger<hw>:FSWEEP[:IMMEDIATE]
:TRIGger<hw>:LFFSweep:IMMEDIATE
```

**:TRIGger<hw>:PSWEEP[:IMMEDIATE]**

**:TRIGger<hw>[:SWEep][:IMMEDIATE]**

Performs a single sweep and immediately starts the activated, corresponding sweep:

- FSWEEP - RF frequency
- PSWEEP - RF level
- LFFSWEEP - LF frequency
- SWEep - all sweeps

Effective in the following configuration:

- TRIG:F SW|LFFS|PSW|[:SWE]:SOUR **SING**
- SOUR:SWE:FREQ|POW:MODE **AUTO** or SOUR:LFO:SWE:[FREQ:]MODE **AUTO**

Alternatively, you can use the IMMEDIATE command instead of the respective SWEep:[FREQ:]|POW:EXECUTE command.

**Example:** TRIG  
Starts all active sweeps.

**Usage:** Event

**Manual operation:** See "[Execute Single Sweep](#)" on page 530

**:TRIGger<hw>:LFFSWEEP**

Executes an LF frequency sweep in the following configuration:

- TRIG:LFFS:SOUR SING
- LFO:SWE:MODE AUTO

**Example:** LFO:SWE:MODE AUTO  
TRIG:LFFS:SOUR SING  
TRIG:LFFSWEEP

**Usage:** Event

## 14.24 UNIT subsystem

The UNIT subsystem is used to set default units for parameters if no unit is indicated in a command. These settings are valid for the entire instrument.

### Example: Setting default units for remote control

```
UNIT:POW V
UNIT:ANGL DEG
UNIT:VEL KMH
```

Sets V (volts) as unit of all power parameters, DEG (degrees) for the phase modulation angle and KMH for the speed.

:UNIT:ANGLE.....	1340
:UNIT:POWer.....	1340
:UNIT:VELOCITY.....	1340

---

**:UNIT:ANGLE** <Angle>

Sets the default unit for phase modulation angle. The command affects no other parameters, such as RF phase, or the manual control or display.

**Parameters:**

<Angle>                   DEGree | DEGRee | RADian  
                               \*RST:        RADian

---

**:UNIT:POWer** <Power>

Sets the default unit for all power parameters. This setting affects the GUI, as well as all remote control commands that determine power values.

**Parameters:**

<Power>                   V | DBUV | DBM  
                               \*RST:        DBM

---

**:UNIT:VELOCITY** <Velocity>

Sets the default unit for the velocity of the wave.

**Parameters:**

<Velocity>                MPS | KMH | MPH | NMPH  
                               \*RST:        MPS

# 15 Troubleshooting and notifications

## Handling R&S SMW200A start-up issues

If the product does not start, a blown fuse in the power supply can be the cause. Contact the Rohde & Schwarz customer service to confirm the fault symptoms. If the power supply has a blown fuse, you must return the product to the Rohde & Schwarz customer service to have the power supply replaced. Follow the instructions from the Rohde & Schwarz customer service.

If you need to transport or ship the instrument, see [Section 16, "Transporting"](#), on page 1356.

## Understanding R&S SMW200A notifications

The R&S SMW200A distinguishes between various notifications caused by events or functions. It displays a notification in the "Info" line on the screen temporarily, and saves all notifications in a history list. In addition, an event initiates an entry in the event/error queue of the status reporting system.

See:

- [Section 13.4, "Status reporting system"](#), on page 826
- [Section 15.4, "Querying notifications"](#), on page 1344

## 15.1 Notifications

Notifications inform about operation states of the instrument, and point out deviations, deficiencies or imperfection of functions that initiate an event in the instrument. The instrument distinguishes the notifications according to the significance of the events by different icons.



Some events require that you eliminate the deviation to make sure that the instrument operates correctly.

To access the notifications and history list dialog, see [Section 15.4, "Querying notifications"](#), on page 1344. In remote control mode, you can query the notifications using the command `:SYSTem:ERRor:ALL?` on page 1300.

### 15.1.1 Volatile notifications

Volatile notifications report automatic settings in the instrument (e.g. switching off incompatible types of modulation) or on entries that are not accepted by the instrument (e.g. range violations).

Volatile notifications do not normally demand user actions and disappear automatically after a short period of time. They are saved in the history list, however.

Remote command:

```
:SYSTem:ERRor:ALL? or
```

```
:SYSTem:ERRor:CODE[:NEXT]?
```

### 15.1.2 Permanent notifications

Permanent notifications are displayed if an error occurs that impairs further instrument operation, e.g. a hardware fault. The error signaled by a permanent notification must be eliminated before correct instrument operation can be continued.

The message is displayed until the error is eliminated. It covers the status display in the info line. After error elimination, the message automatically disappears and is also recorded in the history.

Remote command:

```
:SYSTem:ERRor:STATic?
```

## 15.2 SCPI notifications

The SCPI notifications are similar for all SCPI instruments. Detailed information and an overview of all notifications as defined in the SCPI standard can be found in the corresponding documentation.

SCPI notifications have negative codes (numbers). The error text being entered into the error/event queue or being displayed is printed in bold face on the left together with the error code. Below the error text, there is an explanation to the respective error.

## 15.3 Device-specific notifications

The following table contains all error messages specific for the instrument, marked by positive error codes in numerical order and an explanation of the error situation.

The device-specific error messages set bit 3 in the ESR register.



The index provides a list of the error messages sorted according to their error codes.

Error code	Error	Description	Remedy
50	External reference out of range or disconnected	The configured reference frequency source is external but there is no physical external signal or this signal is out of range.	In the "RF Frequency" > "Reference Frequency" dialog, set the correct reference signal source.
140	This modulation forces other modulations off	The instrument disables a modulation because you enabled another modulation.  For example, if you enable GSM/EDGE modulation, the state of a previously enabled digital modulation is off.	
180	Adjustment failed	The instrument cannot execute an adjustment.	Generate the adjustment data and load it into the device.
182	Adjustment data missing	Adjustment data is missing.	Generate the adjustment data and load it into the device.
183	Adjustment data invalid	Adjustment data is invalid.	Generate the adjustment data and load it into the device.
200	Cannot access hardware	The data transmission to a module was unsuccessful.	The module is not installed, not properly installed or missing.
201	Hardware revision out of date	You cannot execute a specific function because of a too old hardware version.  The driver does not support the installed version of a hardware module.	Consider installing a newer hardware module or downgrading the driver version
202	Cannot access the EEPROM	An error occurs when writing or reading a EEPROM.	The EEPROM is possibly defective. Replace it.
203	Invalid EEPROM data	Reading a EEPROM is possible, however the data are inconsistent.	
204	Driver initialization failed	Initialization of a driver fails when booting the instrument firmware.	The driver is not compatible with the hardware or software configuration of the instrument.
241	No current list	There is no list file selected to execute the required operation.	Select a list file with the correct file extension. If no list files is available, create a list file.
242	Unknown list type specified	The list type selected is not valid for the required operation.  For example, the file extension for waveform list files is *.wv. It is not possible to enter another file extension when selecting a list.	Check the selected list type.
261	Waveform protected	You cannot transfer a waveform file to an Rohde & Schwarz instrument because the file is encrypted. For example, the simulation software R&S WinIQSIM2 creates protected waveform files.	Install the related waveform file software option or select an unprotected waveform file.
460	Cannot open file	You or the application cannot open the selected file.	Check the file path and filename.
461	Cannot write file	You or the application cannot edit or write the selected file.	Check if the file is read-only.
462	Cannot read file	You or the application cannot read the selected file.	Check if the file contents are compatible with the file type.

Error code	Error	Description	Remedy
463	Filename missing	You cannot execute a task because the filename is missing.	Enter the filename.
464	Invalid filename extension	The file extension is not valid for the required operation.	Check the file extension. For example, the file extension for waveform list files is *.wv. It is not possible to enter another file extension when saving a list.
465	File contains invalid data	The file with its file extension contains invalid data. The file extension is wrong for the expected data.  For example, if you change the standard file extension of a waveform file from *.wv to *.txt, the instrument cannot read the waveform file anymore.	Check the file extension.

## 15.4 Querying notifications

The R&S SMW200A monitors the functions performed and automatically detects irregularities. The instrument displays corresponding notifications in the "Info" line and collects all notifications in a history with a detailed description.

Find details to the system notifications in [Section 15, "Troubleshooting and notifications"](#), on page 1341.

### To monitor static notifications and history

- ▶ On the front panel, press the [INFO] key.

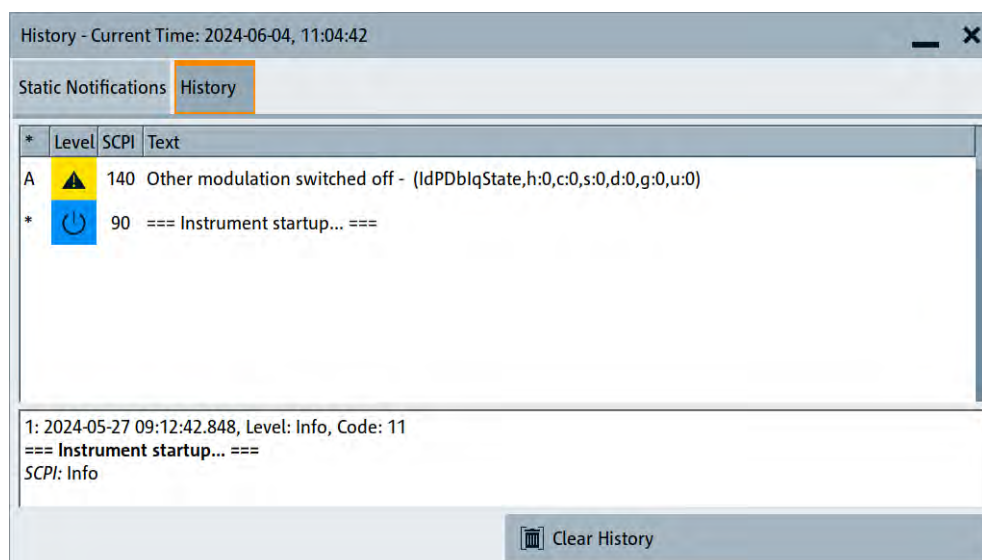

- The "Static Notifications" dialog lists the recently monitored notifications chronologically and displays additional information on the highlighted message.



- The "History" dialog lists the accumulated messages with a short description. The software reports volatile notifications once. The "Info" line displays identical errors repeatedly only if the original error disappeared. Selecting this info line also opens the "Static Notifications" dialog.



### Handling permanent notifications

If any critical error occurs, the R&S SMW200A automatically shows the warning icon  in the taskbar. Select the icon to obtain information on the error and the number of occurrences.

The icon is assigned to permanent notifications. The notification and icon are displayed until the error is eliminated.

### Static Notifications/History

Toggles between "Static Notifications" and the "History" tab in the info dialog.

Remote command:

`:SYSTem:ERRor[:NEXT]?` on page 1302

Each time a `SYST:ERR:NEXT?` query is sent, the eldest entry in the error queue is returned and at the same time cleared in the list.

`:SYSTem:ERRor:STATic?` on page 1303

Queries the list of all errors.

### Clear History

Clears all messages in the "History" tab.

Remote command:

`:SYSTem:ERRor:ALL?` on page 1300

Each time a `SYST:ERR:ALL?` query is sent, the error queue is returned and at the same time cleared.

`:SYSTem:ERRor:HISTory:CLEar` on page 1303

Clears the messages in the "History" view.

## 15.5 Resolving network connection failures

Several issues may cause failures in the network connection to the instrument. This section lists the most likely reasons and the recommended solutions.

### Common reasons for network connection failures

- Network connecting cables and cable connectors of poor quality
- Incompatibility between the network interface of the R&S SMW200A and certain switches or routers available on the market
- An invalid IP address assigned to the instrument

### Possible solutions to network connection failures

1. **NOTICE!** Risk of network failure. Connecting to the network can cause network failure. Errors can affect the entire network.

Consult your network administrator before performing the following tasks:

- Connecting the instrument to the network
- Configuring the network
- Changing IP addresses

2. Try out the following to resolve network connection failures:

- Exchange connecting cables, if obvious damage is visible.  
See also "[Cable selection to minimize electromagnetic interference \(EMI\)](#)" on page 31.
- Observe the link status LED on the R&S SMW200A or the connected network device. The link status LED is located next to the LAN connector.  
If a link failure is detected, connect the instrument to a different device port or to a different network device.
- Check whether the LAN interface and the required LAN services are enabled.  
See [Section 12.7.4, "Configuring LAN services"](#), on page 800.
- If the IP address is set manually (no DHCP) or obtained with the Zeroconf (Avahi) protocol:
  - Check whether the IP address of the instrument is within the network's address range.
  - Check whether the IP address is valid.

See also "[IP Address](#)" on page 831.

## 15.6 Resolving errors during internal adjustments

Internal adjustments can fail for various reasons, e.g. if the adjustment data is invalid or missing, or if any error causes process to abort.

To resolve a failed adjustment process, you have the following options:

- Abort on error (default setting), see "[To resolve aborted internal adjustments](#)" on page 1346
- Continue on error, see "[To continue internal adjustments on error](#)" on page 1347
- Record the adjustment process in a log file and request technical support, see "[To record failed adjustments and request technical support](#)" on page 1347

### To resolve aborted internal adjustments

If an error occurs, the R&S SMW200A displays a notification in the "Information" field and saves the notification in the history list.

1. Select "System Config > Info / Notifications".
2. Look up the error code of the notification in the overview of device-specific notifications.

See [Section 15.3, "Device-specific notifications"](#), on page 1342.

The overview provides a brief explanation of all notifications and information on how to fix an error.

3. To resolve an adjustment failure, generate adjustment data and load it into the instrument.
4. Restart internal adjustments as described in ["Running internal adjustments"](#) on page 1371

If the error persists:

Contact the Rohde & Schwarz customer support, see [Section 15.9, "Collecting information for technical support"](#), on page 1353.

#### To continue internal adjustments on error

If the failed internal adjustments has no significant effect on your application, you can skip it and continue the calibration despite the error message. This function is password-protected.

1. Select "System Config > Setup > Security > Protection".
2. Unlock protection level 1, see ["Protection Level/Password"](#) on page 800.
3. Select "System Config > Setup > Internal Adjustment > Configuration > Continue Adjustment on Error > On".
4. Proceed as described in ["Running internal adjustments"](#) on page 1371.

#### To record failed adjustments and request technical support

Logging the internal adjustment process is password-protected.

1. Select "System Config > Setup > Security > Protection".
2. Unlock protection level 1, see ["Protection Level/Password"](#) on page 800.
3. To enable recording, select "System Config > Setup > Internal Adjustment > Adjustment Configuration" > [Log Debug Info](#) > "On".
4. Send the report to the Rohde & Schwarz customer support for an initial check. See [Section 15.9, "Collecting information for technical support"](#), on page 1353.

## 15.7 Measuring USB cable quality

To check the quality of the USB cable, see the service manual of the R&S SMW200A.

## 15.8 Checking the instrument configuration

The R&S SMW200A uses various hardware and software components. To get an overview, you can check the instrument assemblies, hardware options, software options and the firmware version. The "Hardware Config" and "Versions/Options" dialogs list all components according to their hardware configuration, software options and connected Rohde & Schwarz equipment, like R&S NRP power sensors.

### Installing software and hardware options

Activate newly purchased software options with a keycode. After purchase, the keycode is part of the delivery of the software option. See also [Section 12.5, "Managing licenses and license keys"](#), on page 770.

For installing newly purchased hardware options, contact Rohde & Schwarz customer support.

### Checking the installed hardware options

To find out the installed options:

1. Select "System Config" > "Setup" > "Instrument Assembly" > "Versions / Options".
2. Select "Hardware Options".

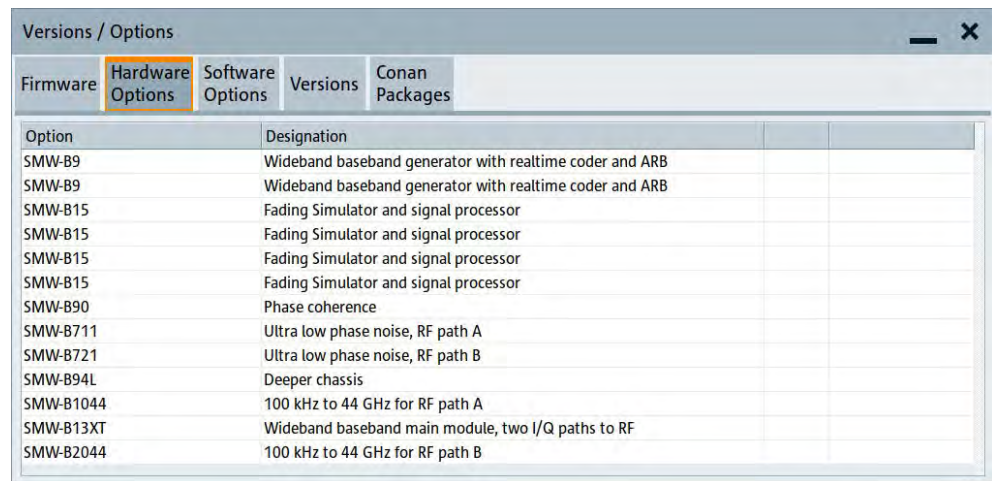

Option	Designation
SMW-B9	Wideband baseband generator with realtime coder and ARB
SMW-B9	Wideband baseband generator with realtime coder and ARB
SMW-B15	Fading Simulator and signal processor
SMW-B15	Fading Simulator and signal processor
SMW-B15	Fading Simulator and signal processor
SMW-B15	Fading Simulator and signal processor
SMW-B90	Phase coherence
SMW-B711	Ultra low phase noise, RF path A
SMW-B721	Ultra low phase noise, RF path B
SMW-B94L	Deeper chassis
SMW-B1044	100 kHz to 44 GHz for RF path A
SMW-B13XT	Wideband baseband main module, two I/Q paths to RF
SMW-B2044	100 kHz to 44 GHz for RF path B

The dialog lists installed hardware options on the R&S SMW200A.

Proceed the same way to get information on the firmware or the installed software options in the corresponding tab.

### Checking the RF hardware assembly

To find out the installed RF hardware:

1. Select "System Config" > "Setup" > "Instrument Assembly" > "Hardware Config".

2. Select "RF Assembly".

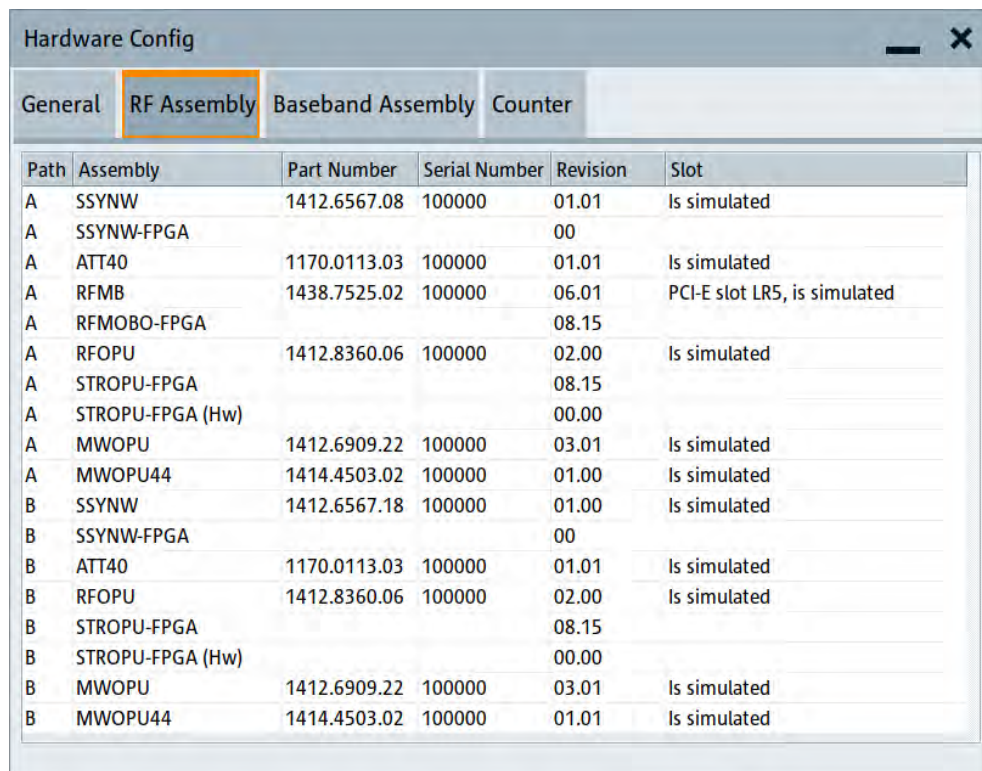

Path	Assembly	Part Number	Serial Number	Revision	Slot
A	SSYNW	1412.6567.08	100000	01.01	Is simulated
A	SSYNW-FPGA			00	
A	ATT40	1170.0113.03	100000	01.01	Is simulated
A	RFMB	1438.7525.02	100000	06.01	PCI-E slot LR5, is simulated
A	RFMOBO-FPGA			08.15	
A	RFOPU	1412.8360.06	100000	02.00	Is simulated
A	STROPU-FPGA			08.15	
A	STROPU-FPGA (Hw)			00.00	
A	MWOPU	1412.6909.22	100000	03.01	Is simulated
A	MWOPU44	1414.4503.02	100000	01.00	Is simulated
B	SSYNW	1412.6567.18	100000	01.00	Is simulated
B	SSYNW-FPGA			00	
B	ATT40	1170.0113.03	100000	01.01	Is simulated
B	RFOPU	1412.8360.06	100000	02.00	Is simulated
B	STROPU-FPGA			08.15	
B	STROPU-FPGA (Hw)			00.00	
B	MWOPU	1412.6909.22	100000	03.01	Is simulated
B	MWOPU44	1414.4503.02	100000	01.01	Is simulated

The dialog lists the installed RF hardware components installed on the R&S SMW200A.

Proceed the same way to get information on general or baseband hardware modules or on the operating times of the R&S SMW200A in the corresponding tab.

### 15.8.1 Hardware configuration settings

Access:

- ▶ Select "System Config" > "Setup" > "Instrument Assembly" > "Hardware Config".

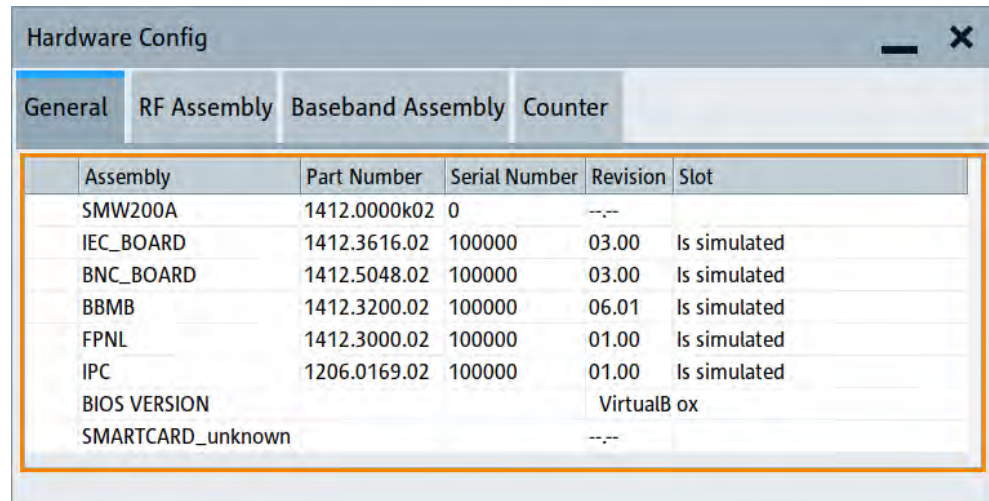

Hardware Config					
General   RF Assembly   Baseband Assembly   Counter					
Assembly	Part Number	Serial Number	Revision	Slot	
SMW200A	1412.0000k02	0	---		
IEC_BOARD	1412.3616.02	100000	03.00	Is simulated	
BNC_BOARD	1412.5048.02	100000	03.00	Is simulated	
BBMB	1412.3200.02	100000	06.01	Is simulated	
FPNL	1412.3000.02	100000	01.00	Is simulated	
IPC	1206.0169.02	100000	01.00	Is simulated	
BIOS VERSION			VirtualBox		
SMARTCARD_unknown			---		

The "Hardware Config" dialog lists all installed assemblies and connected external instruments with information on their part and serial numbers, and revision states. Also, it lists the BIOS version. A firmware update does not update the BIOS version. The "Counter" tab provides information on the operation time, the number of times that the instrument was powered on and the last factory calibration of the instrument.

The remote commands required to query the hardware configuration are described in [Section 14.10, "DIAGnostic subsystem"](#), on page 923.

#### Assembly

The tables in the tabs show characteristics of the installed assemblies.

Connected external instruments are also shown.

"Path" Shows the path to that the assembly belongs.

"Assembly" Assembly designation.

"Part Number" Part number of the assembly.

"Serial Number" Serial number of the assembly.

"Revision" Revision state of the assembly.

"Slot" Indicates whether the assembly is connected to the serial bus or PCI bus.

Remote command:

`:DIAGnostic<hw>:BGInfo?` on page 924

#### Counter

Displays information on the operation times of the R&S SMW200A.

**Operation Time / h ← Counter**

Displays the operation time in hours so far.

Remote command:

[:DIAGnostic:INFO:OTIME?](#) on page 924

**Power On Count ← Counter**

Displays the number the instrument has been turned on.

Remote command:

[:DIAGnostic:INFO:POCount?](#) on page 925

**Last Factory Calibration ← Counter**

Displays the date of the last factory calibration.

Remote command:

[:CALibration:DATA:FACTory:DATE?](#) on page 920

## 15.8.2 Versions and options settings

Access:

- ▶ Select "System Config" > "Setup" > "Instrument Assembly" > "Versions / Options".

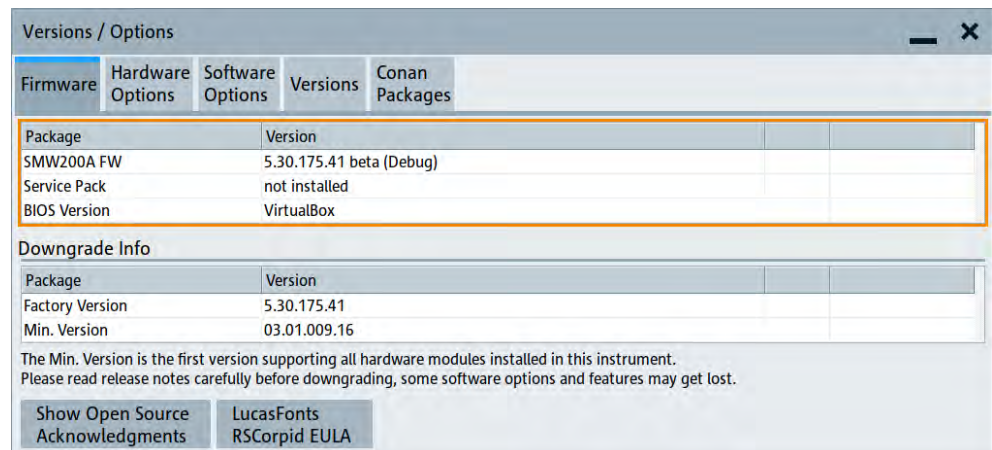

The "Versions / Options" dialog shows the version of the installed instrument firmware, the hardware and software options, the data sheet and the software components of the firmware. The BIOS version is also listed; firmware updates do not update the BIOS version.

The remote commands required to query the hardware configuration are described in [Section 14.10, "DIAGnostic subsystem"](#), on page 923.

**Firmware**

Shows the firmware version and the version of the software platform.

**Note:** Your instrument is delivered with the latest firmware version available.

You can download firmware updates and the "Release Notes" that describe the modifications and the firmware update procedure.

See [www.rohde-schwarz.com/firmware/smw200a](http://www.rohde-schwarz.com/firmware/smw200a)

Remote command:

n.a.

### Downgrade Info

Shows downgrade information, like factory firmware version and minimum firmware version to that the instrument can be downgraded.

Remote command:

n.a.

### Show Open Source Acknowledgments

Accesses the list of the used open-source software packages and the corresponding verbatim license texts.

### LucasFonts RSCorpid EULA

Accesses copyright information on LucasFonts font type RSCorpid EULA.

### Hardware Options/Software Options

The tables in the "Hardware" and "Software" tabs list the installed hardware and software options.

"Option"	Short name of option
"Designation"	Name of option
"Licenses"	(optional) Number of licenses. The licenses for the software options are floating licenses, i.e. for two-path instruments, just one license is required to use the option for either of the two paths. Using the option in both paths simultaneously, you must purchase two licenses.
"Expiration Date"	For regular options, "Permanent" is indicated in this column. For trial or floating license options, the expiration date indicates, how long the option is enabled on the instrument. When the time has elapsed, the R&S SMW200A blocks further use of the option.

Remote command:

\*OPT? on page 900

\*IDN? on page 899

### Versions

The "Versions" tab shows the versions of the technical specification of the R&S SMW200A and of the software components that comprise the firmware.

"Package"	Name of the component.
"Version"	Current issue of the component. E.g. the data sheet covers the technical data of the hardware components of the factory settings. See also <a href="#">Section 13.7.4, "Datasheet"</a> , on page 859.



Remote command:

`:SYSTEM:SPECification:VERSion:FACTory?` on page 1320

## 15.9 Collecting information for technical support

If you encounter problems that you cannot solve yourself, contact your Rohde & Schwarz support center at [www.rohde-schwarz.com/support](http://www.rohde-schwarz.com/support). Our support center staff is optimally trained to assist you in solving problems.

The support center finds solutions more quickly and efficiently if you provide them with information on the instrument and an error description.

- The following dialog boxes in the "Setup > Instrument Assembly" menu provide useful information:
  - **Hardware Configuration:** hardware assemblies
  - **Software and Options:** the status of all software and hardware options installed on your instrument
- **System Messages:** displayed in the "Info" line and provide information on any errors that have occurred
- **Support file:** a special file (\*.tar.gz file) with important support information that can be created automatically.  
The support \*.tar.gz file has a user-definable name and contains the following files and information:
  - SgErrors.txt: chronological record of errors
  - SystemRestorationSMW.savrc1.txt: instrument settings at the last correct shutdown of the instrument
  - UndoHistSuppInfo.xml: list of the last user interactions
  - DeviceFootprint\_<SerialNumber>\_<Date>\_<Time>.xml: service-related information on the instrument's configuration.
  - crashlog.txt, coredump: Postmortem debug info
  - Several files with information on the last performed adjustment and self-test.

See also the description of error messages [Section 15.1, "Notifications"](#), on page 1341.

### To collect error information in a support file

1. Connect a USB device to the R&S SMW200A.
2. Select "System Config > Setup > Maintenance > Create R&S Support Information".
3. In the "Create R&S Support Information" dialog, navigate to the /usb directory. Enter the support filename, for example `RSSupport_DeviceInfo`.

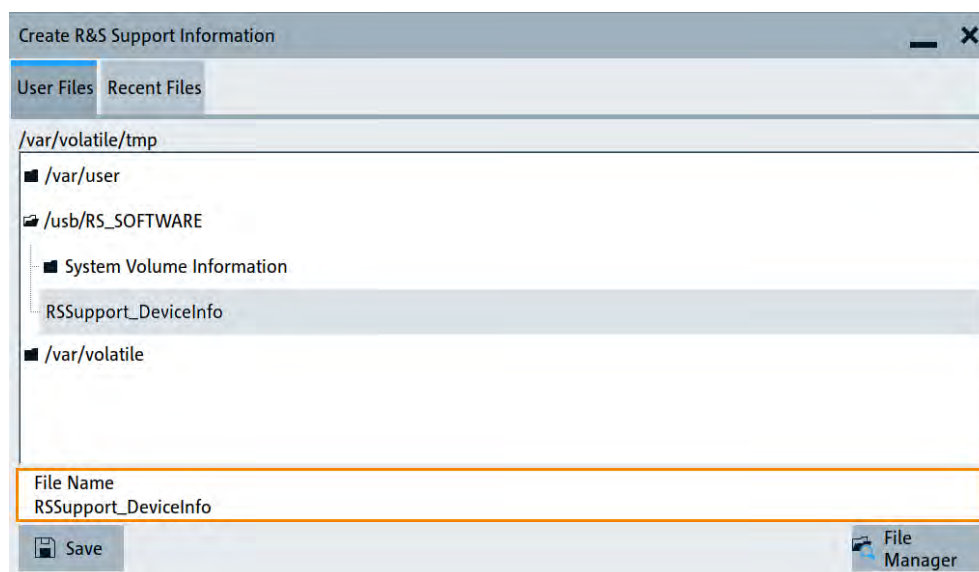

The error information and further required data are collected automatically. The support file `RSSupport_DeviceInfo.tar.gz` is created and stored in the `/usb` directory.

Collect the error information and attach it to an email in which you describe the problem. Send the email to the customer support address as listed on the Internet ([www.rohde-schwarz.com/support](http://www.rohde-schwarz.com/support)).

#### To remove sensitive data

- ▶ For information on how to handle or remove the sensitive data from your instrument, refer to the description "R&S SMW200A Instrument Security Procedures".

#### To pack and transport the instrument

- ▶ If you need to transport or ship the instrument, see [Section 16, "Transporting"](#), on page 1356.

## 15.10 Contacting customer support

### Technical support – where and when you need it

For quick, expert help with any Rohde & Schwarz product, contact our customer support center. A team of highly qualified engineers provides support and works with you to find a solution to your query on any aspect of the operation, programming or applications of Rohde & Schwarz products.

### Contact information

Contact our customer support center at [www.rohde-schwarz.com/support](http://www.rohde-schwarz.com/support), or follow this QR code:



*Figure 15-1: QR code to the Rohde & Schwarz support page*

# 16 Transporting

## Lifting and carrying

For safety information, see:

- ["Lifting and carrying the product"](#) on page 20
- [Section 3.1.1, "Lifting and carrying"](#), on page 28

## Packing

Use the original packaging material. It consists of antistatic wrap for electrostatic protection and packing material designed for the product.

If you do not have the original packaging, use similar materials that provide the same level of protection. You can also contact your local Rohde & Schwarz service center for advice.

## Securing

When moving the R&S SMW200A in a vehicle or using transporting equipment, make sure that the R&S SMW200A is properly secured. Only use items intended for securing objects.

## Transport altitude

The maximum transport altitude without pressure compensation is specified in the specifications document.

# 17 Maintenance, storage and disposal

The product does not require regular maintenance. It only requires occasional cleaning. It is however advisable to check the nominal data from time to time.

## 17.1 Cleaning

How to clean the product is described in "[Cleaning the product](#)" on page 21.

Do not use any liquids for cleaning. Cleaning agents, solvents, acids and bases can damage the front panel labeling, plastic parts and display.

## 17.2 Storage

Protect the product against dust. Ensure that the environmental conditions, e.g. temperature range and climatic load, meet the values specified in the specifications document.

## 17.3 Performing maintenance tasks

The R&S SMW200A is accurate due to integrated adjustment procedures and the following additional capabilities that assure correct functioning:

- **Internal adjustments**  
Internal adjustments are integrated self-calibration routines, which you can execute directly on the instrument.  
How to: See [Section 17.3.4.3, "How to use the internal adjustments"](#), on page 1371.  
Self-calibration routines that require additional equipment are performed at an authorized Rohde & Schwarz service center. For description, see the R&S SMW200A service manual.
- **Self-test**  
A self-test is provided for service purposes.  
We recommend that you perform a selftest, if the instrument does not respond as expected.  
How to: See [Section 17.3.5.4, "How to set up the R&S SMW200A for BNC connections tests"](#), on page 1376.
- **Test points**  
If necessary for service purposes, internal test points can be queried. For description, see the R&S SMW200A service manual.
- [Date and time](#)..... 1358
- [Check front panel](#)..... 1360
- [Check display screen](#)..... 1366

- [Internal adjustments](#)..... 1367
- [Selftest](#)..... 1372
- [FPGA/uC update settings](#)..... 1376
- [Exchanging the RF adapter port](#)..... 1377

### 17.3.1 Date and time

The R&S SMW200A uses an internal real-time clock to determine the date and time. It adjusts the time and date to the timezone of your location automatically, by providing a selection list of continents and cities.

The instrument records the time whenever you create or modify files on your instrument or you use timed licenses. By default, the instrument is set to the UTC timezone, but you can select the timezone according to your location.

Moreover, the instrument supports [NTP](#) protocol for synchronizing all connected instruments and computer systems to minimize time delays in the network.

#### 17.3.1.1 Date and time settings

Access:

- ▶ Select "System Config" > "Setup" > "Maintenance" > "Date / Time".

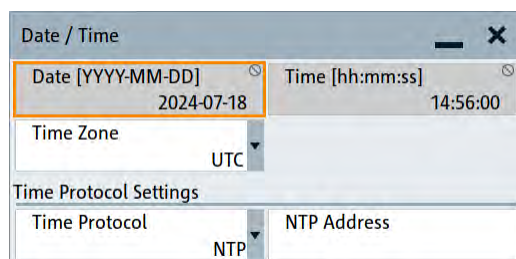

The "Date / Time" dialog contains the time and data settings of the operating system.

This function is password-protected. Unlock the protection level 1 to access it.

You can also set the time zone for your location, and select a time protocol controlled by a time server for synchronization.

The required remote commands are described in [Section 14.20, "SYSTem subsystem"](#), on page 1295.

**Settings:**

- [Date](#)..... 1359
- [Time](#)..... 1359
- [Timezone](#)..... 1359
- [Time Protocol](#)..... 1359
- [NTP Address](#)..... 1359

**Date**

Displays the date set in the operating system in the format [yyyy.mm.dd].

Remote command:

:SYSTem:DATE on page 1321

**Time**

Displays the time set in the operating system in the format [hh.mm.ss].

The time setting corresponds to the selected [Timezone](#).

Remote command:

:SYSTem:TIME on page 1322

**Timezone**

Selects the timezone in the date and time settings of the operating system.

You can select the timezone according to the major cities on the respective continents.

**Tip:** By typing the first letter, you can quickly navigate through the lists to find the desired destination.

Remote command:

:SYSTem:TIME:ZONE on page 1322

:SYSTem:TIME:ZONE:CATaLog? on page 1322

**Time Protocol**

Enables the instrument to refer to a network time protocol.

A network time protocol synchronizes the system clocks of all participating devices in a computer network (Ethernet). A time server in the network provides the time base for the connected devices that refer to this time to synchronize events.

You can select a high-precision time protocol to achieve high clock accuracy and thus reduce the impact of varying network delays.

"None" Refers to the selected timezone, see "[Timezone](#)" on page 1359.

"NTP" Uses the network time protocol (NTP).

Remote command:

:SYSTem:TIME:PROTOcol on page 1323

**NTP Address**

Sets the IP address or host name of the NTP server.

When the server is detected and verified, the instrument enables the connection automatically.

Remote command:

:SYSTem:NTP:HOSTname on page 1321

:SYSTem:NTP:STATe on page 1322

### 17.3.1.2 How to set date and time

#### To select the timezone

1. Press the [SETUP] key.
2. Select "Maintenance > Date /Time > Timezone".
3. Select continent and city of your location.  
**Tip:** By typing the first letter, you can quickly navigate through the lists to find the desired destination.
4. Close the dialogs.

The instrument adjusts the time according to the selected location.

#### To set the date and time

1. **NOTICE!**  
This function is password-protected. Unlock the protection level 1 to access it.  
Since the date and time settings affect time-based options, changing the date and time can therefore lead to loss of access to the function of the options. We recommend that you only change the system time in urgent cases.  
If the time is not displayed correctly, the internal CMOS battery can be discharged. To change the battery, contact your Rohde & Schwarz support center at [www.rohde-schwarz.com/support](http://www.rohde-schwarz.com/support).  
Press the [SETUP] key.
2. Select "Security > Protection".
3. Enable the "Protection Level 1".  
The default password is 123456.
4. Select "Setup > Maintenance > Date / Time".
5. Adjust the settings.
6. Close the dialogs.

The instrument sets the new date and time.

### 17.3.2 Check front panel

Within this dialog, you can verify the functionality of the control keys.

How To: See [Section 17.3.2.2, "How to test the front panel"](#), on page 1361



### 17.3.2.1 Check front panel settings

Access:

- ▶ Select "System Config > Setup > Maintenance > Check Front Panel".

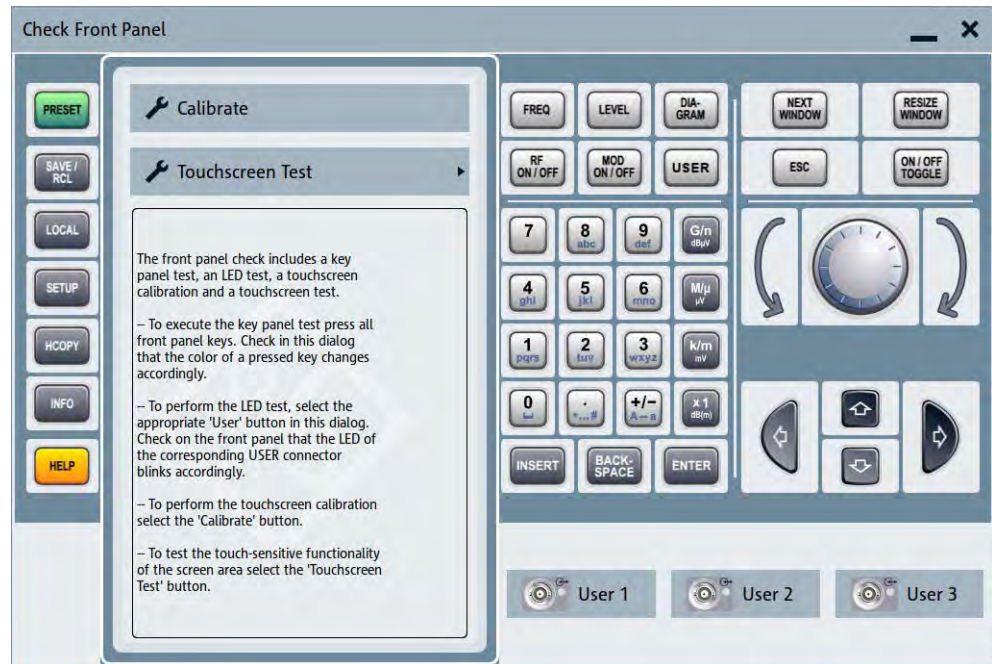

Reflecting the front panel, the "Check Front Panel" dialog contains all functions to test the operating elements of the instrument.

In addition, you can check the touch-sensitive functionality by dragging one or more lines across the screen with your finger.

#### Calibrate

Executes the touchscreen calibration.

See ["Calibrating the touchscreen"](#) on page 1362.

#### Touchscreen Test

Enables you to perform a touchscreen test. This test checks whether the touchscreen area has gaps in the response.

See ["Testing the touchscreen"](#) on page 1364

### 17.3.2.2 How to test the front panel

See:

- ["Calibrating the touchscreen"](#) on page 1362
- ["Testing the key panel"](#) on page 1362
- ["Testing the LEDs"](#) on page 1363
- ["Testing the touchscreen"](#) on page 1364

- "Terminating the test" on page 1365
- "Debugging" on page 1366

### Calibrating the touchscreen

The screen responds to the touch of your finger, that means you can select or activate an item by tapping it. Due to the design of the touchscreen, the capture area is firmly set to a certain size and you do not need to define a range. If the instrument does not respond correctly to the touch, we recommend that you calibrate the touchscreen.

1. Press the [SETUP] key.
2. Select the "Maintenance > Check Front Panel"

The "Check Front Panel" opens.

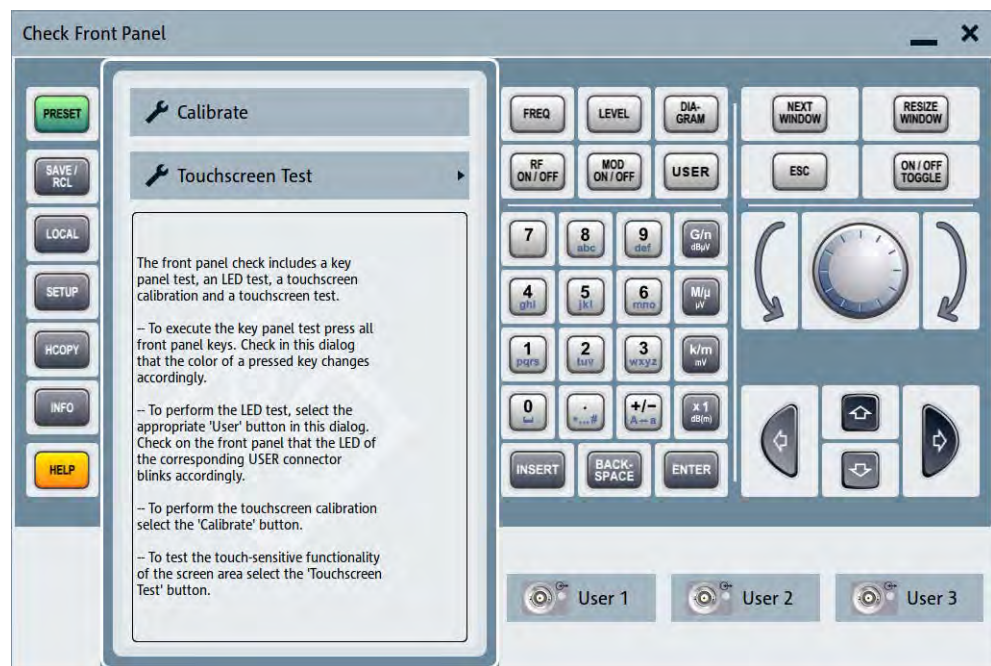

3. Select "Calibrate".
4. Tap the calibration points.

The instrument completes the calibration process automatically and returns to the "Check Front Panel" dialog.

### Testing the key panel

To perform the key panel test, you operate the keys at the front panel, and check the response of the instrument in the "Check Front Panel" dialog. To perform this test properly, check each key of the front panel. The test is only completed, when you have verified all keys.

During the test, the actual functions of the keys are disabled.

1. Press the [SETUP] key.

2. Select "Maintenance > Check Front Panel"  
The "Check Front Panel" dialog opens.
3. Press a key on the front panel.  
Check if the corresponding key in the "Check Front Panel" dialog turns green.
4. Press the same key a second time.  
Check that the key in the dialog turns red.  
**Note:** Pressing the same key again has no further effect, except for the [ESC] key. Pressing this key a third time, terminates the test procedure.
5. Continue with the next key on the front panel and repeat [step 3](#) to [step 5](#) until all keys are tested.

The test is completed, when each key is verified successfully, confirmed by a "Test passed" message.

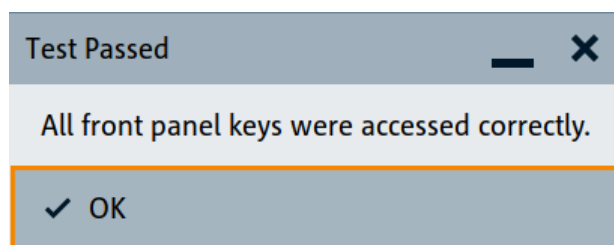

### Testing the LEDs

To perform the LED test, you operate the corresponding "USER" buttons in the "Check Front Panel" dialog, and check the response of the connector LEDs on the front panel. To perform this test properly, check each USER connector. The test is only completed, when you have verified [SETUP] the functionality of all connector LEDs.

Proceed as follows:

1. Press the key.
2. Select "Maintenance > Check Front Panel"  
The "Check Front Panel" dialog opens.
3. Select a "USER" button in the dialog.  
The associated LED in the dialog changes its color.  
Check that the LED of the corresponding USER connector on the front blinks in the same color.
4. Repeat [step 3](#) until all possible colors were displayed once. With the last step, the associated LED in the dialog changes to gray and the "USER" button turns green.  
Check that the LED of the corresponding USER connector on the front panel stops blinking.  
**Note:** Selecting the same user connector again has no further effect.
5. Repeat [step 3](#) and [step 3](#) for the remaining "USER" buttons, until all connector LEDs are tested.

The test is completed, when each LED functionality is verified successfully.

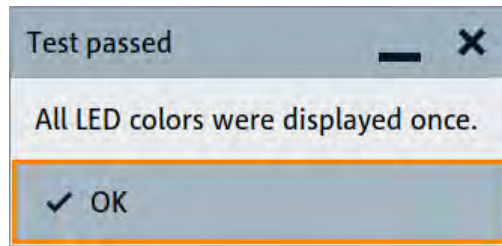

When you have completed the test and close the dialog, the LEDs switch back to the state they had before the test, according to the current settings of the USER connector.

Expected responses:

- Selecting the "USER" button three times (the LED at the front panel is blinking green, yellow, red)
- Selecting the "USER" key once more, the LED turns off.
- After testing all LEDs, a "Test passed" message confirms the success.

### Testing the touchscreen

1. Press the [SETUP] key.
2. Select "Maintenance > Check Front Panel"  
The "Check Front Panel" dialog opens.
3. Select "Touchscreen Test" to access the "Finger Paint" test window.

Press ESC to exit this test.  
Press BACKSPACE to clear the display.  
Press H COPY, SAVE or LOCAL to save a screenshot.  
Press 0..9/turn the rotary knob to change the touch size (50).  
Press ON/OFF TOGGLE for touch connections (Off).  
Press HELP to show/hide this help.

4. Drag with your finger one or more lines, for example diagonally across the screen.  
The test traces the movements of your finger on the screen.

The following results are expected:

- If the lines are uninterrupted, the touchscreen works properly.

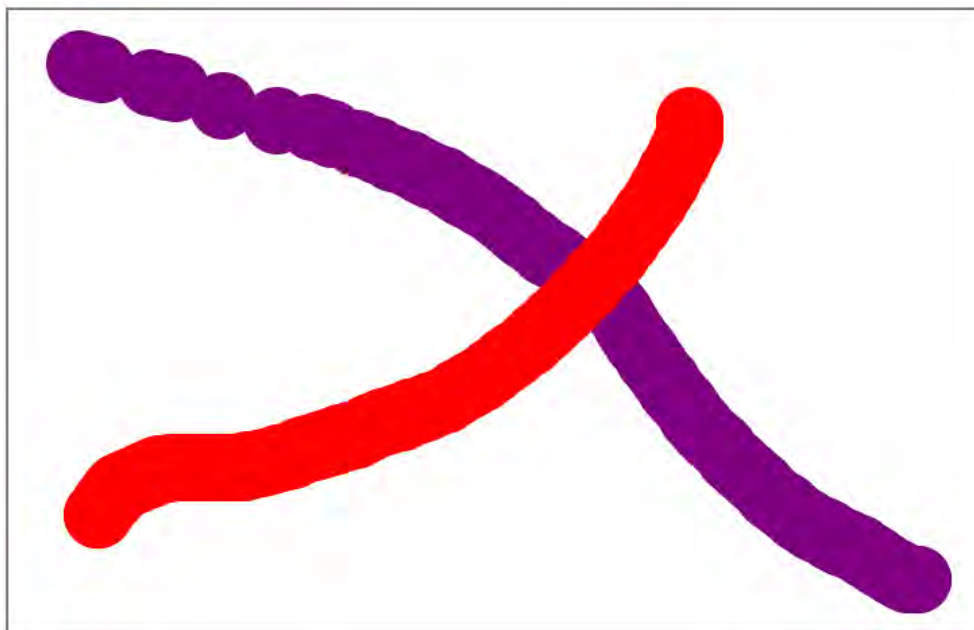

- If there are any gaps, the touch-sensitive functionality is damaged.

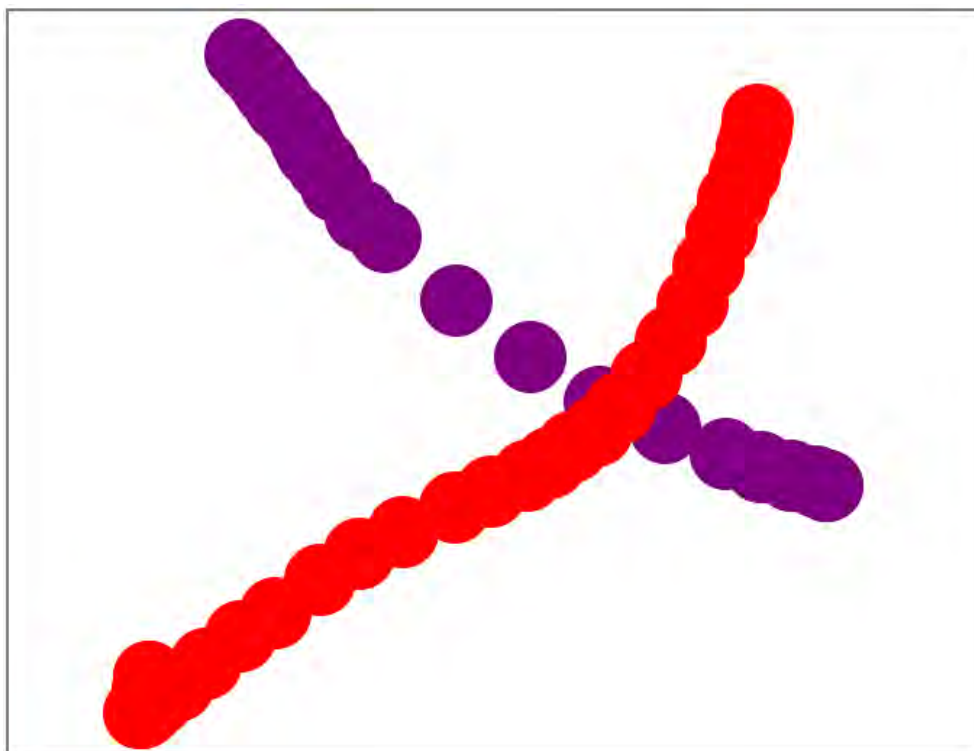

- To return to the "Check Front Panel" dialog, press [ESC].

#### Terminating the test

- ▶ Press the [ESC] key.

Exits the "Check Front Panel" dialog.

### Debugging

1. If you detect a malfunction, for example, when you press the front panel key for the first time, and the color of the button in the dialog turns red (instead of green), the front panel key has probably stuck.
2. Contact the Rohde & Schwarz customer support, see [Section 15.9, "Collecting information for technical support"](#), on page 1353.

### 17.3.3 Check display screen

Using this function, you can verify the color depth and gradient, pixels and the text display of the screen.

Access:

- ▶ Select "System Config > Setup > Maintenance > Check Display Screen".  
The R&S SMW200A fades out the current display and indicates the screen in red. Short instructions on the screen explain how to execute the test.

The remote commands required to define these settings are described in [Section 14.22, "TEST subsystem"](#), on page 1330.

#### Testing the display screen

1. Press the [SETUP] key.
2. Select "Maintenance > Check Display Screen"  
The "Check Display Screen" window opens.
3. Test the color and gradient of the display screen:



- a) Use the [HELP] key to hide the indicated text.

- b) To toggle between the provided colors manually, use the navigation controls [Left/Right] or the rotary knob.  
The R&S SMW200A provides the colors red, green, blue, white, three levels of gray shades and black.
  - c) To switch between the screen colors automatically, use the [Up] key.
  - d) To toggle the gradient, use the [Down] key.
4. Check if the R&S SMW200A indicates the text correctly:
    - a) Press [1] on the numeric keypad.  
The R&S SMW200A displays a test text over the entire screen.
    - b) To inspect the text in detail, you can use the rotary knob to zoom it out.
  5. To exit the test, press the [ESC] key.

[Check Display Screen](#)..... 1367

### Check Display Screen

Opens the test window with instructions on how to perform the test.

Remote command:

`:TEST:PIXel:WINDow` on page 1336

`:TEST:PIXel:COLor` on page 1335

`:TEST:PIXel:RGBA` on page 1336

`:TEST:PIXel:GRADient` on page 1335

`:TEST:PIXel:TEXT` on page 1336

`:TEST:PIXel:POINTsize` on page 1336

## 17.3.4 Internal adjustments

Using the integrated adjustment procedures, you can start the calibration directly on the instrument.

### 17.3.4.1 Internal adjustment settings

Access:

- ▶ Select "System Config > Setup > General > Internal Adjustments".

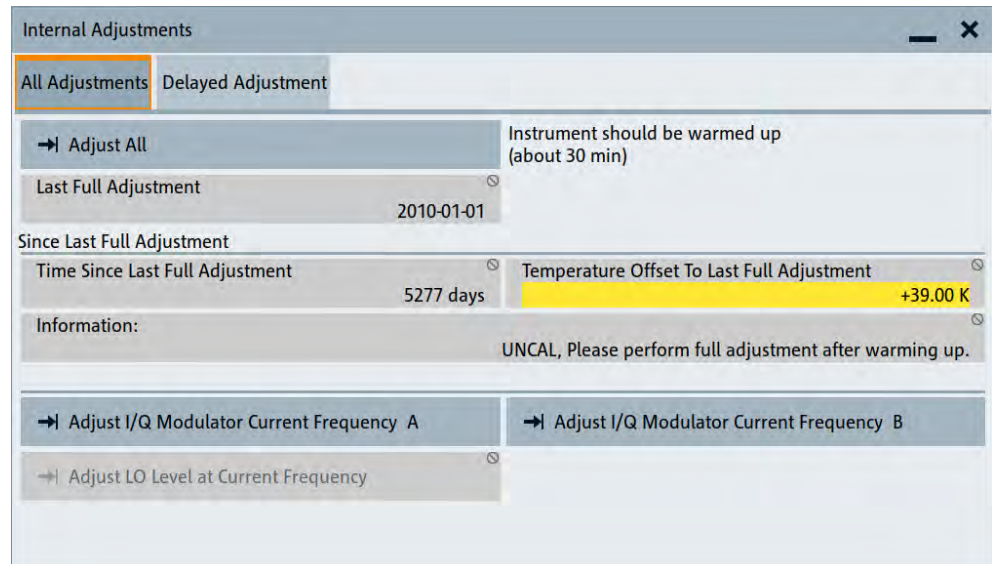

In this dialog, you can perform internal calibration routines, and get information on the last performed calibration.

The "Temperature Offset" indicates the deviation of the current temperature of the instrument, compared to the temperature of the last adjustment.

The remote commands required to define these settings are described in [Section 14.8, "CALibration subsystem"](#), on page 917.

How to: See [Section 17.3.4.3, "How to use the internal adjustments"](#), on page 1371.

## Settings

### Adjust All

Executes all available internal calibration routines in each path of the instrument.

**Note:** "Adjust All" is disabled when an R&S SZU IQ Upconverter is connected. In this configuration, the R&S SMW200A provides the adjustment of the R&S SZU, see [Adjust External Frequency Converter](#).

**Note:** Before you start the internal adjustment, make sure that you have connected a termination resistor, if necessary.

Remote command:

`:CALibration:ALL[:MEASure]?` on page 918

### Last Full Adjustment

Displays the date of the last fully performed adjustment.



Remote command:

`:CALibration<hw>:ALL:DATE?` on page 918

### Time

Displays the elapsed time since the last full adjustment.

If the last adjustment has been performed more than 100 days ago, the background color of the parameter turns red.

Remote command:

`:CALibration<hw>:ALL:TIME?` on page 919

### Temperature Offset

Displays the temperature difference, comparing the temperature of the last adjustment to the current instrument temperature.

A green checkmark indicates that the offset is within the permitted range. If the temperature deviates more than  $\pm 5$  K, the instrument indicates a warning icon.

Remote command:

`:CALibration<hw>:ALL:TEMP?` on page 919

### Information

Displays information to the current adjustment state.

Remote command:

`:CALibration<hw>:ALL:INformation?` on page 919

### Adjust I/Q Modulator Current Frequency

Starts the adjustment for the I/Q modulator for the currently set frequency and base-band gain. The I/Q modulator is adjusted regarding carrier leakage, I/Q imbalance and quadrature.

How to: ["To correct systematic I/Q modulation errors"](#) on page 461

Remote command:

`:CALibration<hw>:IQModulator:LOCal?` on page 921

### Adjust LO Level at Current Frequency

Adjusts the level of the oscillator signal to optimum, if an external LO signal is applied.

See ["To adjust the LO level to the current frequency"](#) on page 505.

The function is enabled in the following cases:

- An external "LO Coupling Mode" is selected.
- "Out State" is on ("B On" or "On").

**Note:** If your test setup consists of several cascaded Rohde & Schwarz instruments, always use an external oscillator signal and start the LO level adjustment with the first instrument. Continue in the order up to the last.

Remote command:

`:CALibration<hw>:LOSCillator:COUpling:LOCal?` on page 922

### Adjust External Frequency Converter

Calibrates the parameters of an externally connected R&S SZU IQ Upconverter.

The function is available when an R&S SZU is connected and activated.

Remote command:

`:CALibration<hw>:FREQuency:CONVerter:EXTernal?` on page 922

### Continue Adjustment on Error

Continues the calibration even though an error was detected. By default adjustments are aborted on error.

This function is password-protected. Unlock the protection level 1 to access it.

Remote command:

`:CALibration<hw>:CONTinueonerror` on page 919

### Log Debug Info

Activates logging of the internal adjustments.

This function is password-protected. Unlock the protection level 1 to access it.

Remote command:

`:CALibration<hw>:DEBug` on page 921

## 17.3.4.2 Delayed adjustment settings

Access:

- ▶ Select "System Config > Setup > General > Delayed Adjustment".

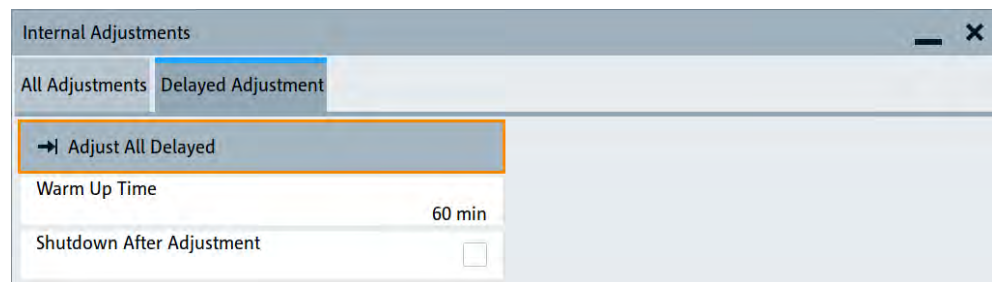

In this dialog, you can set the internal adjustments to start automatically after the selected warm up time and to switch off the instrument after calibration.

The remote commands required to define these settings are described in [Section 14.8, "CALibration subsystem"](#), on page 917.

### Settings

<a href="#">Adjust All Delayed</a> .....	1370
<a href="#">Warm Up Time</a> .....	1371
<a href="#">Shutdown After Adjustment</a> .....	1371

### Adjust All Delayed

Performs all available internal calibration routines of the instrument, considering all installed paths.

**Note:** "Adjust All" is disabled when an R&S SZU IQ Upconverter is connected. In this configuration, the R&S SMW200A provides the adjustment of the R&S SZU, see [Adjust External Frequency Converter](#).

How to: See [Starting internal adjustments automatically](#).

Remote command:

`:CALibration:DELAy[:MEASure]?` on page 921

#### Warm Up Time

Sets the time for warming up the instrument before the calibration starts automatically.

How to: See [Starting internal adjustments automatically](#).

Remote command:

`:CALibration:DELAy:MINutes` on page 920

#### Shutdown After Adjustment

Enables the automatic shutdown after internal adjustments.

How to: See [Starting internal adjustments automatically](#).

Remote command:

`:CALibration:DELAy:SHUTdown[:STATe]` on page 920

### 17.3.4.3 How to use the internal adjustments

#### Deciding whether to run internal adjustments

1. Select "System Config > Setup > Internal Adjustment".
2. Check the status and color indication in the section "Since Last Full Adjustment".  
Green: internal adjustments are not required.  
Red: internal adjustments are required. Observe also the indication in the "Information" field.
3. We recommend that you run internal adjustments in the following cases:
  - Before starting any application that requires a maximum of level accuracy.
  - When a long period of time has passed since the last adjustments.
  - If the ambient temperature of the instrument significantly differs from the one of the last adjustments.
4. Proceed as described in ["Running internal adjustments"](#) on page 1371.

#### Running internal adjustments

1. After switching on, the R&S SMW200A requires up to 30 minutes to warm up. Wait until the instrument has reached operating temperature to achieve accurate adjustments.
2. Select "System Config > Setup > Internal Adjustment > Adjust All".  
In two-path instruments, you can adjust each path separately.
3. Confirm with "Ok".

The adjustment process starts.

The adjustment process takes some time depending on the equipment of the instrument.

A status dialog shows progress of the current adjustment step. If necessary, you can stop the adjustments after a completed step.

If any error occurs, the process aborts. To resolve adjustment issues, see [Section 15.6, "Resolving errors during internal adjustments"](#), on page 1346.

### Starting internal adjustments automatically

The delayed adjustment function executes the adjustments automatically. You can set the warm-up time and shut down after the adjustment process finishes. Using this function, you can execute adjustments without being on-site and start measurements directly when back.

1. If necessary, terminate the RF A/RF B output. See ["Running internal adjustments"](#) on page 1371.
2. Select "System Config > Setup > General > Internal Adjustment".
3. Select "Delayed Adjustment".
4. Set the "Warm Up Time", e.g. *40 min*.  
The R&S SMW200A requires a warm-up time of at least 30 min.
5. Enable "Shut Down After Adjustment"
6. Select "Adjust All Delayed".

The process starts with warming up the instrument, indicating the progress in a status dialog. In this dialog, you can abort the process again, if necessary.

After warming up, the R&S SMW200A executes the internal adjustments and shuts down when finished.

### 17.3.5 Selftest

Self-test is provided for service purposes.

### 17.3.5.1 Selftest connections settings

Access:

- ▶ Select "System Config > Setup > Maintenance > Selftest > Connections".

The "Connections" dialog contains the parameters for testing the signal flow at the connectors.

The remote commands required to define these settings are described in [Section 14.22, "TEST subsystem"](#), on page 1330.

<a href="#">Execute Baseband Connections Test</a> .....	1373
<a href="#">BNC Connections Test</a> .....	1373
L <a href="#">Source</a> .....	1373
L <a href="#">Destination</a> .....	1374
L <a href="#">Execute BNC Connection Test</a> .....	1374
L <a href="#">Log Message</a> .....	1374

#### Execute Baseband Connections Test

Performs a connection test on each of the internal digital baseband links.

The test implies to all installed options as baseband inputs, motherboard, universal coding generators, fading simulators, and baseband outputs.

The result (succeeded or failed) is displayed in the status field on the right.

Remote command:

n.a.

#### BNC Connections Test

This function is password-protected. Unlock the protection level 1 to access it.

#### Source ← BNC Connections Test

Selects the BNC connector source to be tested.

Remote command:

:TEST:BB:BNC:SOURce on page 1332

**Destination ← BNC Connections Test**

Selects the BNC connector destination to be tested.

Remote command:

s:TEST:BB:BNC:DESTination on page 1331

**Execute BNC Connection Test ← BNC Connections Test**

Performs the BNC connection test at the selected connectors.

Remote command:

:TEST:BB:BNC:CONNECTION? on page 1331

**Log Message ← BNC Connections Test**

Displays the log message reported during the BNC connections test.

Remote command:

:TEST:BB:BNC:LOG? on page 1332

**17.3.5.2 Selftest baseband settings**

Access:

- ▶ Select "System Config > Setup > Maintenance > Selftest > Baseband".

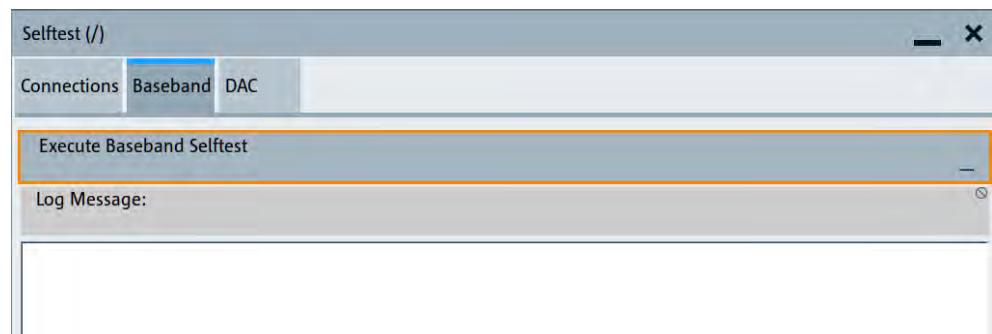

In the "Baseband" dialog you can execute the baseband selftest.

The remote command required to start the test is described in [Section 14.22, "TEST subsystem"](#), on page 1330.

**Execute Baseband Selftest**

Performs a baseband selftest.

The result (succeeded or failed) is displayed in the status field on the right.

Remote command:

:TEST:BASeband? on page 1331

**Log Message**

Displays the log message reported during the baseband test.

Remote command:

:TEST:BASeband:LOG? on page 1331

### 17.3.5.3 Self-test DAC settings

Access:

1. This function is password-protected. Unlock the protection level 1 to access it.
2. Select "System Config" > "Setup" > "Maintenance" > "Selftest".
3. Select "DAC".

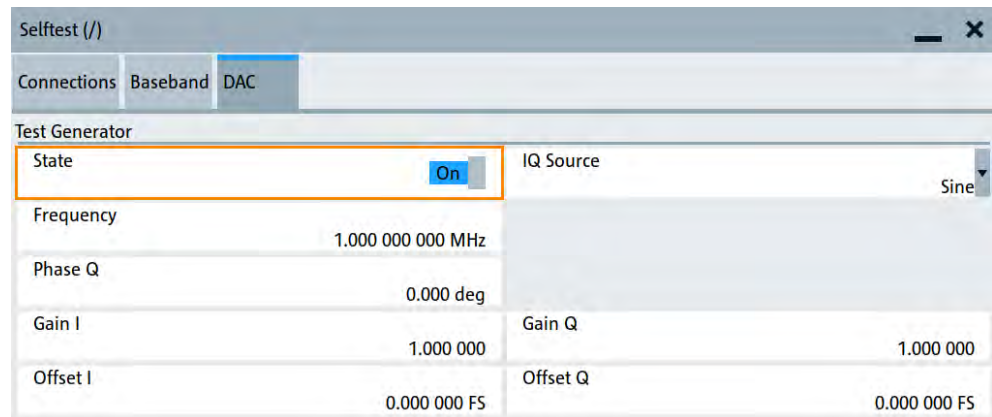

The "DAC" tab provides test generator settings of the digital-analog converter to test the I/Q signal source.

The remote commands required to define these settings are described in [Section 14.22, "TEST subsystem"](#), on page 1330.

<a href="#">State</a> .....	1375
<a href="#">IQ Source</a> .....	1375
<a href="#">Gain</a> .....	1376
<a href="#">Frequency</a> .....	1376
<a href="#">Select ARB File</a> .....	1376

#### State

Starts the test generator.

Remote command:

:TEST:BB:GENerator:STATe on page 1334

#### IQ Source

Selects the test signal source.

- |                |  |
|----------------|--|
| "Sine"         | Generates a sine waveform with frequency as set with the parameter <a href="#">Frequency</a> .                             |
| "Constant I/Q" | Uses a constant I/Q test signal.<br>See <a href="#">Section 5.7.3.4, "Constant IQ test signal settings"</a> , on page 317. |
| "ARB"          | Selects a signal generated by the ARB. Select the waveform file with the parameter <a href="#">Select ARB File</a> .       |

Remote command:

`:TEST:BB:GENerator:SOURce` on page 1333

### Gain

Sets the gain for a sine or a constant I/Q test signal.

Remote command:

`:TEST:BB:GENerator:GAIN` on page 1333

### Frequency

Requires "IQ Source" > "Sine".

Sets the frequency of the test signal.

Remote command:

`:TEST:BB:GENerator:FREQuency<ch>` on page 1333

### Select ARB File

Provides access to the standard "File Select" function of the instrument. The provided navigation possibilities in the dialog are self-explanatory.

See also, chapter "File and Data Management" in the R&S SMW200A User Manual.

Remote command:

`:TEST:BB:GENerator:ARBitrary` on page 1333

#### 17.3.5.4 How to set up the R&S SMW200A for BNC connections tests

1. This function is password-protected. Unlock the protection level 1 to access it.
2. Select "System Config > Setup > Maintenance > Selftest > Connections".
3. Select the BNC **Source** (signal output).
4. Select the BNC **Destination** (signal input).
5. On the instrument, connect the selected "Source" connector with the "Destination" connector.  
The selection list in the dialog shows you where to find the associated connector on the instrument.
6. Select "Execute BNC Connections Test".

#### 17.3.6 FPGA/uC update settings

Access:

- ▶ Select "System Config > Setup > Maintenance > FPGA/μC Update".





This dialog enables you to check for internal assembly updates and perform updates.

**Settings:**

FPGA/μC..... 1377

**FPGA/μC**

Performs an update of the FPGA/μC.

Remote command:

n.a.

### 17.3.7 Exchanging the RF adapter port

It is important, that you take care that the RF connectors applied to the port are clean, mechanically compatible and not damaged. Although the 1.85 mm adapter is designed to withstand several hundred mating cycles, it can reach the end of life or be damaged. Therefore, the adapter port is exchangeable, and you can replace it.

For the corresponding instructions on how to proceed, see the R&S SMW200A Service Manual provided on the global Rohde & Schwarz information system under <https://gloris.rohde-schwarz.com>.

## 17.4 Disposal

Rohde & Schwarz is committed to making careful, ecologically sound use of natural resources and minimizing the environmental footprint of our products. Help us by disposing of waste in a way that causes minimum environmental impact.

### Disposing of electrical and electronic equipment

A product that is labeled as follows cannot be disposed of in normal household waste after it has come to the end of its life. Even disposal via the municipal collection points for waste electrical and electronic equipment is not permitted.



*Figure 17-1: Labeling in line with EU directive WEEE*

Rohde & Schwarz has developed a disposal concept for the eco-friendly disposal or recycling of waste material. As a manufacturer, Rohde & Schwarz completely fulfills its obligation to take back and dispose of electrical and electronic waste. Contact your local service representative to dispose of the product.

# Annex

## A Available user files and file extensions

The table [Table A-1](#) lists available file extensions for user files on the instrument. Some files depend on the installed options.

For more information, refer to the specifications document.

**Table A-1: User files and file extensions on the instrument**

Context or function	Content type	File contents	File extension
Instrument state	Settings	Instrument settings	*.savrc1txt
User menu	Settings	User-defined favorite settings	*.user_menu
License key	License	License key	*.xml
User correction	List	User-defined level correction values	*.uco
List Mode	List	User-defined frequency/level value pairs	*.lsw
Power sensing	Settings	R&S NRP settings	*.nrp, *.rsu
SCPI command list	List	Export file containing list of SCPIs	*.iec
SCPI command script	Command script	SCPI script file formats: Plain SCPI, MATLAB, NICVI, Python3	*.txt, *.m, *.c, *.py
R&S support information	Support file	Automatically collected support information	*.tar.gz
Tutorials	Tutorial files	Lists containing SCPIs and explanations	*.tut
ARB	Waveform	ARB waveforms ARB multi-segment waveforms	*.wv
ARB	I/Q data files	I/Q data	*.iq.tar, *.csv, *.mat
ARB	Waveform	ARB multicarrier settings	*.arb_multcarr
ARB	Configuration data	Configuration file for creation of multisegment ARB waveforms	*.inf_msv
ARB	Play List	ARB Sequencing List	*.wvs
Baseband filtering	Settings	User Filter	*.dat
I/Q data file	Settings	User-defined I/Q-File	*.iqw
Custom digital modulation	Data List	Digital modulation data	*.dm_iqd *.tdm
Custom digital modulation	Control List	Data to control digital modulation	*.dm_iqc
Custom digital modulation	Settings	Digital modulation settings	*.dm
Custom digital modulation	User standard	Digital modulation user standard	*.dm_stu

Context or function	Content type	File contents	File extension
Custom digital modulation	User mapping	Digital modulation user mapping	*.vam
Custom digital modulation	User Filter	Digital modulation user filter	*.vaf
Frequency response correction	Settings	User-defined baseband frequency response correction file	*.frc
Envelope tracking	Setting	Envelope shaping function (shaping table)	*.iq_lut *.iq_lutpv
Envelope tracking	Settings	Envelope shaping function (polynomial coefficients)	*.iq_poly
Digital predistortion	Settings	DPD settings	*.dpd
Digital predistortion	Settings	Predistortion function (AM/AM and AM/PM shaping table)	*.dpd_magn *.dpd_phase
Digital predistortion	Settings	Predistortion function (polynomial coefficients)	*.dpd_poly
GSM/EDGE	Settings	Complete settings of the GSM/EDGE dialog	*.gsm
GSM/EDGE	Slot	User-defined slot data	*.gsm_slu
GSM/EDGE	Frame	User-defined frame data	*.gsm_fu
GSM/EDGE	Slot	Higher symbol rate slot	*.gsm_hslu
GSM/EDGE	Frame	Higher symbol rate frame	*.gsm_hfu
Bluetooth	Bluetooth settings	Complete setting of the Bluetooth dialog	*.bto
TETRA	TETRA settings	Complete setting of the TETRA dialog	*.tetra
3GPP FDD	Settings	Complete setting of the 3GPP FDD dialog	*.3g
3GPP FDD	Settings	Channel coding enhanced DPCH channels (downlink)	*.3g_ccod_dl
3GPP FDD	Settings	Channel coding enhanced DPDCH channels (uplink)	*.3g_ccod_ul
3GPP FDD	Settings	User scheduling	*.3g_sch
CDMA2000	Settings	Complete setting of the CDMA2000 dialog	*.cdma2k
TD-SCDMA	Settings	Complete setting of the TD-SCDMA2000 dialog	*.tdscdma
TD-SCDMA	Settings	Test Model for TD-SCDMA2000	*.tdtmd
1xEV-DO	Settings	Complete setting of the 1xEV-DO dialog	*.1xevdo
IEEE 802.11	Settings	Complete setting of the IEEE 802.11 WLAN dialog	*.wlan
EUTRA/LTE	Settings	Complete setting of the EUTRA/LTE dialog	*.eutra *.lte
EUTRA/LTE	Settings	TDD settings	*.lte_tdd
5G NR	Settings	Complete setting of the 5G NR signal generation dialog	*.nr5g
OFDM signal generation	Settings	Complete setting of the OFDM signal generation dialog	*.c5g
NFC	Settings	Complete setting of the NFC dialog	*.nfc

Context or function	Content type	File contents	File extension
Baseband power ramping	Settings	Complete setting of the BB Power Ramp dialog	*.pwr_ramp
GNSS, Fading	Settings	Vehicle description file	*.xvd
GNSS, Fading	Settings	Trajectory description file	*.xtd
GNSS, Fading	Settings	Antenna pattern	*.ant_pat
GNSS	Settings	Complete setting of the GPS/A-GPS dialog	*.gps
GNSS	Settings	GPS Almanac settings	*.txt *.alm *.al3
GNSS	Settings	GPS Waypoints File	*.txt
GNSS	Settings	GPS-generated Almanac file	*rs_al *.rs_yuma
GNSS	Settings	GPS ionospheric file	*.rs_ion
GNSS	Settings	GPS navigation data	*.rs_nav
GNSS	Settings	GPS UTC file	*.rs_utc *.rs_acq
Response file	Settings	Response file	*.txt
Software extension	Extension files	Import file for extensions	*rsux
Fading	Settings	Fading data	*.fad
Radar echo generation	Settings	Complete setting of the REG dialog	*.reg
Radar echo generation	Settings	REG object settings	*.reg_obj
IEEE 802.16 WiMAX	Settings	Complete setting of the IEEE 802.16 WiMAX dialog	*.wimax
DVB	Settings	Complete setting of the DVB dialog	*.dvb
DVB	Settings	DVB Transport Stream	*.gts *.ts *.trp
Pulse sequencing	Settings	Settings of the extended pulse sequencer application	*.eseq
Pulse sequencing	Archive	R&S SMW200A settings of the extended pulse sequencer application, including all used files	*.ps_arc

## B Unit shortcuts

When specifying units or quantities during data entry, the R&S SMW200A provides the following shortcuts for simplified input.

Shortcut	Designation	Context	Unit
a, A	ampere	Current	A
	atto-	Area, surface	am <sup>2</sup>
c, C	centi-	Distance, length	cm
d, D	deci-	Distance, length	dm
		Level, power	dB, dBFS, dBm, dBu, dBW
	degree	Phase, polar/spherical coordinates	deg
e, E	exa-	Area, surface	em <sup>2</sup>
f, F	femto-	Area, surface	fm <sup>2</sup>
g, G	giga-	Area, surface	Gm <sup>2</sup>
		Data rate, sample rate, symbol rate	Gbit/s, Gsample/s, Gsymbol/s, Gchip/s
		Frequency	GHz
		Impedance, resistance	GΩ
h, H	hertz	Frequency	Hz
k, K	kilo-	Area, surface	km <sup>2</sup>
		Data rate, sample rate, symbol rate	kbit/s, ksample/s, ksymbol/s, kchip/s
		Distance, length	km
		Frequency	kHz
		Impedance, resistance	kΩ
		Velocity	km/h
m, M	milli-	Area, surface	mm <sup>2</sup>
		Current	mA
		Distance, length	mm
		Electromagnetic force, level	mV
		Power	mW
		Time, period, etc.	ms
	mega-	Area, surface	Mm <sup>2</sup>
		Data rate, sample rate, symbol rate	Mbit/s, Msample/s, Msym/s, Mchip/s
		Frequency	MHz
		Impedance, resistance	MΩ

Shortcut	Designation	Context	Unit
n, N	nano-	Area, surface Current Distance, length Electromagnetic force, level Power Time, period, etc.	nm <sup>2</sup> nA nm nV nW ns
o, O	ohm	Impedance, resistance	Ω
p, P	peta-	Area, surface	pm <sup>2</sup>
	percent	Level, ratio	%
	pico-	Area, surface Current Electromagnetic force, level Power Time, period, etc.	pm <sup>2</sup> pA pV pW ps
r, R	radiant	Phase, polar/spherical coordinates	rad
s, S	second	Time, period, etc.	s
t, T	terra-	Area, surface Data rate, sample rate, symbol rate Frequency Impedance, resistance	Tm <sup>2</sup> Tbit/s, Tsample/s, Tsym/s, Tchip/s THz TΩ
u, U	micro-	Current Distance, length Electromagnetic force, level Power Time, period, etc.	μA μm μV μW μs
v, V	volt	Level, voltage	V
w, W	watt	Level, power	W

## C Naming conventions in the user interface

The naming convention in the user interface follows a rule that enables you to recognize to which **Stream**, path, or **Entity** the corresponding dialog and/or functional block is related.

Consider the following naming conventions:

- **Standard mode**

In this mode, the functional blocks are dedicated to a stream/baseband, i.e. one functional block provides the configuration settings for one stream/baseband. The name of the stream/baseband is appended to the name of the equivalent functional block/dialog:

$\langle \text{Functional block} \rangle + \langle \text{Stream} \rangle = \langle \text{Functional block/Dialog} \rangle$

### Example: Naming conventions in standard mode

The name of the "AWGN" functional block and the name of the "AWGN Settings" dialog (see [Figure C-1](#)) is formed as follows:

"<AWGN>" + "<Stream A >" = "<AWGN A>"

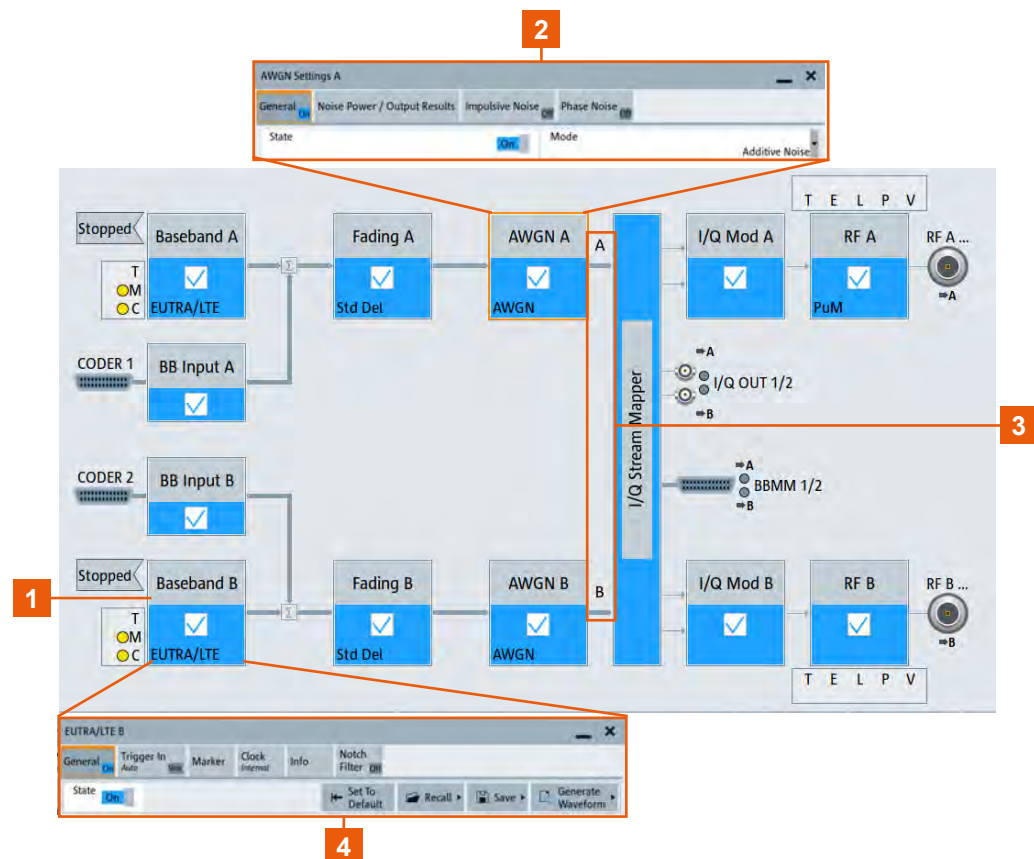

**Figure C-1: Explanation of the naming convention for standard mode**

1, 2 = Dialog and functional blocks of "Stream A" or "Stream B".  
3, 4 = Dialog and functional block of "Baseband B".

- **Advanced mode**  
In **Advanced mode**, the functional blocks are not always dedicated to a stream/baseband. The applied naming rule depends on further settings, like the selected baseband source and number of entities.
  - While using **Coupled sources**, there is only one functional block that provides specific configuration settings for all streams/basebands. Hence, there is no special attachment to the name of the functional block/dialogs:  
"<Functional block> = <Functional block/Dialog>"
  - In multiple entity mode, one functional block controls the settings of several streams. The number of the entity is appended to the name of the dialog:  
"<Functional block> + <Entity number> = <Functional block/Dialog>"

### Example: Naming conventions in advanced mode and coupled sources

There are no attachments to the name of the "AWGN" functional block or to the name of the "AWGN Settings" dialog (see [Figure C-2](#)).



**Figure C-2: Explanation of the naming convention for coupled sources**

- 1, 4 = No appending to the name of the baseband
- 2, 3 = Configuration of all streams in one dialog



**Example: Naming conventions in multi-entity advanced mode**

The name of the "AWGN" functional block and the name of the "AWGN Settings" dialog (see [Figure C-3](#)) is formed as follows:

"<AWGN> + <Entity 1> = <AWGN 1>"

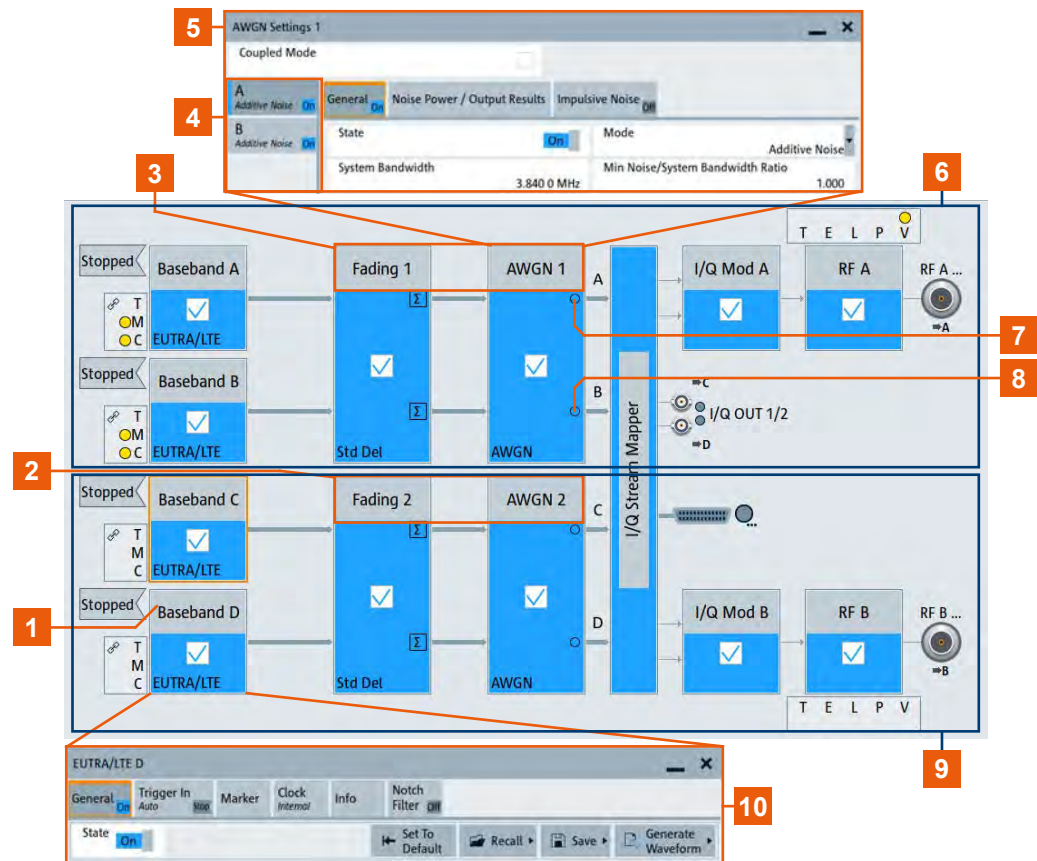

**Figure C-3: Explanation of the naming convention for a multi-entity mode**

- 1, 2 = Functional blocks and dialog of "Entity 2".
- 3, 5 = Functional blocks and dialog of "Entity 1".
- 4, 7, 8 = Confirms the configuration of the streams corresponding to the same baseband in one dialog.
- 6 = "Entity 1"
- 9 = "Entity 2"
- 10 = Dialog of "Baseband D".

## D ARB file formats CSV and MAT

This section provides information on the format and the structure of I/Q data in ARB files with file extension \*.csv and \*.mat.

### CSV file format

The table [Table D-1](#) provides parameters and exemplary values of CSV files for loading these files into the ARB application of the R&S SMW200A. Make sure that your CSV file follows the order and name of these parameters. Separate parameters and values by a semicolon. The file requires all mandatory parameters, you can omit optional parameters.

**Table D-1: \*.csv file parameters and values**

Parameter	Value	Requirement
Name	TestImportInSMW	mandatory
Comment	test to import csv in siggen.	mandatory
DateTime	2024-2-2T18:47:33	mandatory
Format	complex	mandatory
DataType	float32	mandatory
NumberOfChannels	1	mandatory
Ch1_ChannelName	Kanal0	mandatory
Ch1_Samples *)	2	mandatory
Ch1_Clock[Hz]	2.20E+9	mandatory
Ch1_CenterFrequency[Hz]	1.33E+9	mandatory
Kanal0_I		mandatory
Kanal0_Q		mandatory
I_1 *)	0.9	mandatory
Q_1 *)	0	mandatory
I_2 *)	0	mandatory
Q_2 *)	0.9	mandatory

\*) Make sure that the number of samples per channel `Ch<n>_Samples` equals the number of I/Q pairs `I_<n>` and `Q_<n>`. For example, if channel 1 has two samples (`Ch1_Samples = 2`), set also values for the two I/Q pairs (`I_1,Q_1` and `I_2,Q_2`).

**Example: CSV file with 6 I/Q samples**

```
# ARB CSV file format
MandatoryData
Name;                               TestImportInSMW
Comment;                             test to import csv in siggen.
DateTime;                             2024-2-2T18:47:33
Format;                               complex
DataType;                             float32
NumberOfChannels;                     1
Ch1_ChannelName;                     Kanal0
Ch1_Samples;                          6
Ch1_Clock[Hz];                       2.20E+9
Ch1_CenterFrequency[Hz];             1.33E+9
DataImportExport_EndHeaderSection
Kanal0_I;                             Kanal0_Q
I_1;                                  Q_1
I_2;                                  Q_2
I_3;                                  Q_3
I_4;                                  Q_4
I_5;                                  Q_5
I_6;                                  Q_6
```

**MAT file format**

Creating and editing files with file extension \*.mat requires installation of MATLAB:

<https://mathworks.com/products/matlab.html>

The table [Table D-2](#) provides parameters and exemplary values of MAT files for loading these files into the ARB application of the R&S SMW200A. Make sure that your MAT file follows the order and name of these parameters. The file requires all mandatory parameters, you can omit optional parameters.

**Table D-2: \*.mat file parameters and values**

Parameter	Value	Requirement
Ch1_CFrequency_Hz	0.1000	mandatory
Ch1_ChannelName	'IQValues'	mandatory
Ch1_Clock_Hz	2.0000e+09	mandatory
Ch1_Data *)	[1;0;0,1;-1;0;0,-1]	mandatory
Ch1_Samples *)	4	mandatory
Comment	'This is a file to show how a MATLAB file looks like.'	mandatory
DataType	'float32'	mandatory
Format	'complex'	mandatory
Name	'fileToTestMatlabImport'	mandatory
NumberOfChannels	1	mandatory

\*) Make sure that the number of samples per channel `Ch<n>_Samples` equals the number of I/Q pairs `I_<n>` and `Q_<n>` of the `Ch<n>_Data` parameter. For example, if channel 1 has two samples (`Ch1_Samples = 2`), set also values for the two I/Q pairs (`Ch1_Data = [I_1,Q_1;I_2,Q_2]`).

## E Available tutorial files

The R&S SMW200A provides a set of tutorials embedded in the software. The tutorials are interactive examples and demonstrations on how to perform specific tasks.

This section lists the tutorial files supplied with the R&S SMW200A.

For information on how to access, start and work with the tutorials, follow the instructions listed in [Section 3.5.6.1, "Using the tutorials"](#), on page 97.

Tutorial Type	Tutorial Name	Goal
First steps with the R&S SMW200A	01_UnmodulatedSignal	Generating a simple unmodulated signal
	02_DigitallyModulatedSignal	Generating a simple WCDMA-3GPP (QPSK 45°Offset) signal with the help of the "Custom Digital Modulation" functionality
	03_ExternalTriggerSignal	Understanding the general principle of external triggering
	04_MarkerSignal	Understanding the principle of marker signal generation
	05_SignalRouting	Get started with signal routing
	06_VisualizeSignal	Verifying the generated signal with the graphics display
	07_SaveRecallSettings	Storing instrument configuration to restore measurements results later
	08_LTESignal_Basics	Generating a simple LTE signal to get familiar with the settings and configuration principle common for the digital standards
	09_MIMO_GettingStarted	Shows how to use coupled baseband sources and select a suitable fading and baseband configuration to generate an EUTRA/LTE signal in 2x2 MIMO configuration
Get started with baseband power measurements	90_BBPowerMeas_ContAcquisition	Using the continuous acquisition mode to analyze a continuous WLAN 802.11 signal
	91_BBPowerMeas_GatedAcquisition	Using the gated acquisition mode to analyze a particular part of a burst WLAN 802.11 signal
	92_BBPowerMeas_MultiGatedAcquisition	Using the multi-gated acquisition mode to analyze a particular part of a burst WLAN 802.11 signal
Advanced Configuration Tasks	30_LTE_CA_2x2MIMO_CrossSched	Generating an 2x2x2 LTE-A signal with two component carriers (intra-band carrier aggregation with cross-carrier scheduling) and 2x2 MIMO each carrier
	40_ArbMultiSegmentSignal	Create a multi-segment waveform.
	99_DefineUserKeyActions	Assigning action to the [USER] key

## F Reference information for remote control

### F.1 Telnet program examples

The following program example shows a simple `TcpClient` class that is intended to explain on how to get started with programming of sockets.

The example sets up a socket communication to R&S SMW200A and opens a simple user interface, very similar to the telnet, which allows input of commands. To enable real automation, further development of the program is required.

#### TcpClient.h

```
#include <string>
//defines structs for socket handling
#include <netinet/in.h>
using namespace std;
typedef struct sockaddr_in SockAddrStruct;
typedef struct hostent      HostInfoStruct;
class TcpClient
{
public:
    TcpClient();
    ~TcpClient();
    void connectToServer( string &hostname, int port );
    void disconnect( );
    void transmit( string &txString );
    void receive( string &rxString );
    string getCurrentHostName( ) const;
    int    getCurrentPort( ) const;
private:
    string          currentHostName;
    int             currentPort;
    int             currentSocketDescr;
    SockAddrStruct  serverAddress;
    HostInfoStruct * currentHostInfo;
    bool            clientIsConnected;
    int             receiveBufferSize;
};
```

#### TcpClient.cpp

```
#include <string>
//defines structs for socket handling
#include <netinet/in.h>
using namespace std;
typedef struct sockaddr_in SockAddrStruct;
typedef struct hostent      HostInfoStruct;
```

```

class TcpClient
{
public:
    TcpClient();
    ~TcpClient();
    void connectToServer( string &hostname, int port );
    void disconnect( );
    void transmit( string &txString );
    void receive( string &rxString );
    string getCurrentHostName( ) const;
    int    getCurrentPort( ) const;
private:
    string      currentHostName;
    int         currentPort;
    int         currentSocketDescr;
    SockAddrStruct  serverAddress;
    HostInfoStruct * currentHostInfo;
    bool        clientIsConnected;
    int         receiveBufferSize;
};

#include <netdb.h>
#include <netinet/in.h>
#include <unistd.h>
#include "TcpClient.h"
TcpClient::TcpClient()
: currentHostName( "" )
, currentPort( 0 )
, currentSocketDescr( 0 )
, serverAddress ( )
, currentHostInfo( NULL )
, clientIsConnected( false )
, receiveBufferSize( 1024 )
{
}
TcpClient::~~TcpClient()
{
    currentHostInfo = NULL;
}

void TcpClient::connectToServer( string &hostname, int port )
{
    currentHostInfo = gethostbyname( hostname.c_str( ) );
    if( currentHostInfo == NULL )
    {
        currentHostName = "";
        currentPort     = 0;
        currentHostInfo = NULL;
        clientIsConnected = false;
        printf("error connecting host\n" );
    }
}

```

```

    }
    currentHostName = hostname;
    currentPort     = port;
    currentSocketDescr = socket(AF_INET, SOCK_STREAM, 0);
    if( currentSocketDescr == 0 )
    {
        currentHostName = "";
        currentPort     = 0;
        currentHostInfo = NULL;
        clientIsConnected = false;
        printf("can't create socket\n" );
    }
    serverAddress.sin_family = currentHostInfo->h_addrtype;
    serverAddress.sin_port   = htons( currentPort );
    memcpy( (char *) &serverAddress.sin_addr.s_addr,
    currentHostInfo->h_addr_list[0], currentHostInfo->h_length );
    if( connect( currentSocketDescr, ( struct sockaddr *) &serverAddress,
    sizeof( serverAddress ) ) < 0 )
    {
        throw string("can't connect server\n" );
    }
    clientIsConnected = true;
}
void TcpClient::disconnect( )
{
    if( clientIsConnected )
    {
        close( currentSocketDescr );
    }
    currentSocketDescr = 0;
    currentHostName   = "";
    currentPort       = 0;
    currentHostInfo   = NULL;
    clientIsConnected = false;
}
void TcpClient::transmit( string &txString )
{
    if( !clientIsConnected )
    {
        throw string("connection must be established before any data can be sent\n");
    }
    char * transmitBuffer = new char[txString.length() +1];
    memcpy( transmitBuffer, txString.c_str(), txString.length() );
    transmitBuffer[txString.length()] = '\n'; //newline is needed!
    if( send( currentSocketDescr, transmitBuffer, txString.length() + 1, 0 ) < 0 )
    {
        throw string("can't transmit data\n");
    }
    delete [] transmitBuffer;
}

```



```

void TcpClient::receive( string &rxString )
{
    if( !clientIsConnected )
    {
        throw string("connection must be established before any data can be received\n");
    }
    char * receiveBuffer = new char[receiveBufferSize];
    memset( receiveBuffer, 0, receiveBufferSize );
    bool receiving = true;
    while( receiving )
    {
        int receivedByteCount = recv( currentSocketDescr,
            receiveBuffer, receiveBufferSize, 0 );
        if( receivedByteCount < 0 )
        {
            throw string("error while receiving data\n");
        }
        rxString += string( receiveBuffer );
        receiving = ( receivedByteCount == receiveBufferSize );
    }
    delete [] receiveBuffer;
}

string TcpClient::getCurrentHostName( ) const
{
    return currentHostName;
}

int TcpClient::getCurrentPort( ) const
{
    return currentPort;
}

```

### TelnetClient.cpp

```

#include <iostream>
#include "TcpClient.h"
void printUsage()
{
    cout<<"usage: EthernetRawCommand <server-ip> [scpi-command]"<<endl;
}

int main( int argc, char *argv[] )
{
    int errorCode          = 0; //no error
    bool useSingleCommand = false;
    string singleCommand  = "";
    string hostname       = "";
    int    port           = 5025;
    string input          = "";
    TcpClient client;
    switch( argc )
    {

```

```
case 3:
    useSingleCommand = true;
    singleCommand    = argv[2];
case 2:
    hostname         = argv[1];
    break;
default:
    printUsage();
    return(-1);
}
try
{
    client.connectToServer( hostname, port );
    bool terminate = false;
    while( !terminate )
    {
        char buffer[1024];
        if( useSingleCommand )
        {
            input = singleCommand; //send string
        }
        else
        {
            cin.getline( buffer, 1024 );
            input = buffer;
            if( input == "end" )
            {
                terminate = true;
            }
        }
        if( !terminate)
        {
            client.transmit( input ); //send string
            int qPos = input.find( "?", 0 );
            //receive string only when needed
            if( qPos > 0 )
            {
                string rcStr = "";
                client.receive( rcStr );
                cout << rcStr << endl;
            }
        }
        if( useSingleCommand )
        {
            terminate = true;
        }
    }
}catch( const string errorString )
{
    cout<<errorString<<endl;
}
```

```

}
client.disconnect( );
return errorCode;
}

```

## F.2 GPIB interface

This section provides detailed information on the general-purpose interface bus (GPIB) interface "IEC 625/IEEE 488" for remote control of the instrument. It covers the following topics:

- "Pin assignment" on page 1395
- "Bus lines" on page 1395
- "Interface functions" on page 1396

For other remote control interfaces, see [Section 13, "Network operation and remote control"](#), on page 816.

### Pin assignment

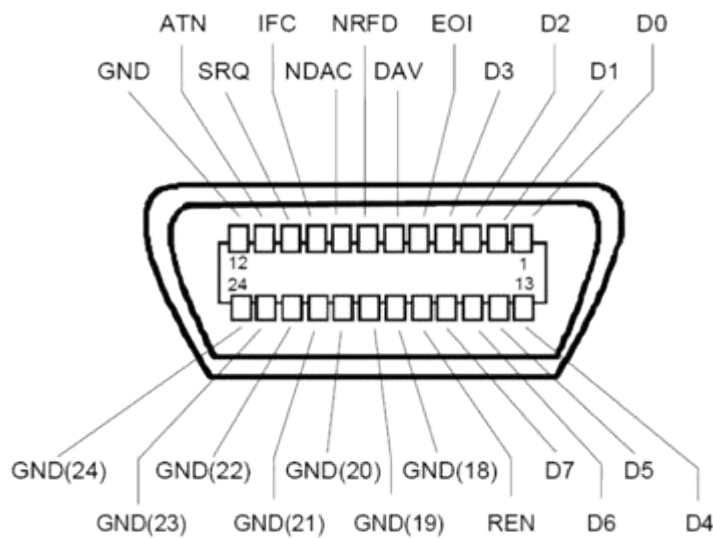

Figure F-1: Pin assignment of the GPIB interface

### Bus lines

- Data bus with eight lines D0 to D7:  
The transmission is bit-parallel and byte-serial in the ASCII/ISO code. D0 is the least significant bit, D7 the most significant bit.
- Control bus with five lines:  
**IFC** (Interface Clear): active LOW resets the interfaces of the instruments connected to the default setting.

**ATN** (Attention): active LOW signals the transmission of interface messages, inactive HIGH signals the transmission of device messages.

**SRQ** (Service Request): active LOW enables the connected device to send a service request to the controller.

**REN** (Remote Enable): active LOW permits switchover to remote control.

**EOI** (End or Identify): two functions in connection with ATN:

- ATN=HIGH active LOW marks the end of data transmission.
- ATN=LOW active LOW triggers a parallel poll.

- Handshake bus with three lines:

**DAV** (Data Valid): active LOW signals a valid data byte on the data bus.

**NRFD** (Not Ready For Data): active LOW signals that one of the connected devices is not ready for data transfer.

**NDAC** (Not Data Accepted): active LOW signals that the instrument connected is accepting the data on the data bus.

### Interface functions

You can use different interface functions to control the instrument via the GPIB interface. [Table F-1](#) lists the interface functions for the R&S SMW200A.

**Table F-1: GPIB interface functions**

Control character	Interface function
SH1	Handshake source function (source handshake), full capability
AH1	Handshake sink function (acceptor handshake), full capability
L4	Listener function, full capability, de-addressed by MTA.
T6	Talker function, full capability, ability to respond to serial poll, deaddressed by MLA
SR1	Service request function (Service Request), full capability
PP1	Parallel poll function, full capability
RL1	Remote/Local switch-over function, full capability
DC1	Reset function (Device Clear), full capability
DT1	Trigger function (Device Trigger), full capability

For more information, refer to the specifications document.

## G RF hardware versions

The functions and settings in the RF domain depend on the versions of the installed hardware assemblies, since several hardware components have been replaced by improved modules.

Basically, the description in the manual refers to the latest versions of the hardware assemblies, but points out settings that apply to earlier RF hardware versions.

The following sections however show the main changes in brief, with the current components listed first, followed in descending order by the corresponding configuration of earlier RF hardware versions.

For more information, refer to the specifications document.

### G.1 RF assemblies and options

The main focus of new RF hardware components is the synthesizer and RF frequency components. In addition, new phase noise options and their impact on the signal attenuation have also been improved.

The following table shows the differences. Options that are available for instruments with the new RF hardware components and the earlier RF hardware versions are not mentioned.



Remarks on high frequency options of RF path B:

- Option R&S SMW-K720 (AM/FM/φM) is not available for R&S SMW-B2031/-B2044(N).  
An instrument equipped with these frequency options, turns off the signal generation in path B when you activate an analog modulation in path A.
- Options R&S SMW-B2012/-B2031/-B2044(N) require a deeper housing of the R&S SMW200A (R&S SMW-B94L), configured in the factory. Therefore, these options are not retrofittable.

Synthesizer	RF frequency options	Reference frequency	Phase noise performance options	Analog modulation options
SSYNW 1412.6567.02	R&S SMW <ul style="list-style-type: none"> <li>-B1003/-B1006/... (path A)</li> <li>-B2003/...(path B)</li> </ul>	R&S SMW <ul style="list-style-type: none"> <li>-K703 (1 GHz reference)</li> <li>-K703 (100 MHz reference, low noise)</li> <li>-K704 (1 MHz to 100 MHz variable reference)</li> </ul>	R&S SMW <ul style="list-style-type: none"> <li>-B709/-B710/... (path A)</li> <li>-B719/-B720/... (path B)</li> </ul>	<ul style="list-style-type: none"> <li>R&amp;S SMW-K720 AM/FM/PhiM (not available for R&amp;S SMW-B2031/-B2044(N))</li> </ul>
SSYN 1412.6667.02	R&S SMW- <ul style="list-style-type: none"> <li>-B103/-B106/... (path A)</li> <li>-B203/... (path A)</li> </ul>	---	R&S SMW-B22 enhanced phase noise & FM/PhiM modulator	R&S SMW <ul style="list-style-type: none"> <li>-B20 FM/PhiM modulator</li> <li>R&amp;S SMW-B22 enhanced phase noise &amp; FM/PhiM modulator</li> </ul>
SSYN 1141.4220.02				

See the specifications document for information on all RF frequency and RF enhancement options, the provided path combinations and the corresponding RF characteristics.

## G.2 Affected parameters and settings

The following table shows the impact of the new RF hardware components on the setting parameters, denoted by the synthesizer versions.

For more information, refer to the specifications document.

**Table G-1: Reference oscillator settings**

Synthesizer	External RF reference frequency	Minimum frequency locking range	Reference frequency output
SSYNW 1412.6567.02	<ul style="list-style-type: none"> <li>10 MHz, 100 MHz, 1 GHz</li> <li>100 MHz low noise</li> <li>1 MHz to 100 MHz</li> <li>Variable</li> </ul>	Depends on the synchronization bandwidth setting (narrow/wide) and the installed phase noise options R&S SMW-B709/-B710/-B711.	<ul style="list-style-type: none"> <li>10 MHz, 100 MHz, 1 GHz</li> <li>100 MHz low noise</li> <li>Input signal (loop through)</li> </ul>
SSYN 1412.6667.02	<ul style="list-style-type: none"> <li>10 MHz</li> <li>1 MHz to 100 MHz variable</li> </ul>	Depends on the synchronization bandwidth setting (narrow / wide) and the installed phase noise option R&S SMW-B22.	<ul style="list-style-type: none"> <li>Same as reference input</li> <li>10 MHz derived from Ref. output</li> </ul>
SSYN 1141.4220.02	5 MHz, 10 MHz or 13 MHz		

# Glossary: Terms and abbreviations

## A

**Advanced mode:** This term is used as an abbreviation of the "System Configuration" > "Mode" > "Advanced". This mode is available in instruments equipped with some required hardware and software options, like up to 4xR&S SMW-B14 and the R&S SMW-K74.

The advanced mode extends the [Standard mode](#) with MIMO configurations like 2x2 MIMO, higher-order MIMO modes (e.g. 4x4, 2x8 and 8x2 MIMO), or multiple entity modes (e.g. 2x2x2 or 8x1x1 configurations).

**Avahi:** A licensed [Zeroconf](#) networking feature, including DNS service. The feature enables a device to self-configure an IP address and subnet mask automatically, when a [DHCP](#) server in the LAN is not available.

## B

**Base unit:** This term describes a R&S SMW200A equipped with the options R&S SMW-B10, R&S SMW-B13 and R&S SMW-B1003.

**Baseband:** The baseband signal, i.e. the I/Q stream at the output of the "Baseband" block.

In rear cases, the term Baseband is used as abbreviation of a "Baseband" block itself.

**Baseband domain:** A common term for signal processing up to the I/Q modulation. The signal in the baseband domain of the R&S SMW200A is digital.

**Baseband signal:** [Baseband](#)

**BBMM:** Short designation of the Baseband Main Module (the bottommost board on the rear panel of the R&S SMW200A).

**Beamforming:** Steering a beam in the direction of the receiver, e.g. UE

**BS:** Basestation

## C

**Channel (Digital Input, Digital Output):** The signal provided at a digital interface connector or the output stream at the digital output interface can consist of several multiplexed channels. Do not mistake the term *channel* used here with the terms [Fading channel](#) or signal path.

A digital channel is a part of an I/Q stream.

**Clock:** A mandatory internal or an external reference clock signal for generating the timing pulse in the instrument.

**Complete file path:** The complete file path specifies the root directory and all subdirectories that contain a file or folder.

Synonyms to this expression are "full file path" and "absolute file path".

See also [Section 14.7.2, "Handling files in the default or in a specified directory"](#), on page 906.

**Computer name:** [Hostname](#)

**Continuous Wave Mode:** [CW/Mod](#)

**Coupled sources:** This term is used as an abbreviation of the "System Configuration" > "BB Source Config" > "Coupled Sources"/"Coupled Sources per Entity".

With coupled sources, all required baseband signals are generated out of the same baseband source.

**Coupled trigger settings:** To enable simultaneous signal generation in all basebands, the R&S SMW200A couples the trigger settings in the available basebands in any instrument's configuration that involves signal routing with signal addition. For example, in configurations like MIMO configuration, routing and summing of basebands and/or streams.

**CW/Mod:** An internally generated control signal that turns off/on digital modulation, i.e. the signal is generated in unmodulated form.

## D

**Daisy chain:** A connection scheme in which instruments are connected together in sequence, i.e. an output of the first one is connected to an input of the second one, etc.

**DHCP:** Dynamic Host Configuration Protocol

**DNS:** Domain Name System server

## E

**e.g.:** For example

**Earlier RF hardware versions:** Refers to instruments equipped with former hardware assemblies.

To improve the signal performance of the R&S SMW200A, several hardware components in the RF domain have been replaced. New option numbers denote the hardware modifications, as for example R&S SMW-B1006. This term denotes the differences to previous versions of the hardware assemblies and the corresponding option numbers.

See [Section G, "RF hardware versions"](#), on page 1397.

**Entity:** An entity is a *self-contained independent system*, consisting of a baseband source, a fading simulator, a noise generator, and an RF part. An entity describes the desired signal, modulated on a common carrier frequency. An example of an entity is a



user/mobile station or a cell/base station in one digital standard (e.g. 3GPP FDD, EUTRA/LTE, etc.).

The R&S SMW200A can generate the signals of up to 4 entities with a 2x2 MIMO each or up to 8 SISO systems.

## F

**Fading channel:** In a 2x2 MIMO fading configuration, there are four fading channels between the transmit (Tx) and the receive (Rx) antennas. In this description, each fading channel is represented as a block with name following the naming convention "F<sub><Tx><Rx></sub>", where Tx and Rx are the antennas (e.g. A and B in a 2x2 MIMO configuration)

Do not mistake the terms fading channel and [Fading path](#).

**Fading path:** Each [Fading channel](#) consists of several fading paths. The number of the paths depends on the fading configuration.

**File transfer:** The transmission of files from or to the instrument by a remote client. The instrument supports the standard methods File Transfer Protocol (FTP) and file sharing according to Server Message Protocol (SAMBA/SMB).

## G

**Glossary:** List of the often used terms and abbreviations

**GUI:** Graphical User Interface

## H

**HDD:** Hard disk drive, see [System drive](#)

**High frequency options:** This term is used as a joint abbreviation of the frequency options R&S SMW-B1031/-B1040/-B1040N. Throughout this description, the designation R&S SMW-B1040 includes the features of both options R&S SMW-B1040/-B1040N.

**Hostname:** An unambiguous indication of the instrument in a LAN that uses a [DNS](#) server.

The default hostname follows the syntax `SMW-<serial number>`, e.g.

`SMW200A-102030`.

See [Serial number](#).

Synonym: [Computer name](#)

**HUMS:** Health and utilization monitoring system.

## I

**i.e.:** Short for "that is".

**I/Q Stream:** [Stream](#)

**L**

**Level:** In the Baseband domain, a term describing the signal level of the independent I and Q signals during signal processing (e.g. baseband signal leveling, modulation, etc.).

**LSB:** Least significant bit

**LxMxN:** Short form of the used system configuration, where L represents the [Entity](#), M the [Baseband](#) and N the [Stream](#).  
See also [MxN](#)

**M**

**Marker:** User-defined digital signal for synchronizing external devices to the generated data stream.  
Do not mistake the term *marker (signal)* used here with the term [Marker \(graphical signal display\)](#).

**Marker (graphical signal display):** Markers are tools for numerical readout of measured data in diagrams.

**Marker signal:** [Marker](#)

**MIMO:** Multiple Input Multiple Output

**MSB:** Most significant bit

**Multi entity:** multiple entity

**Multiple entities:** Term describing a [LxMxN](#) system configuration with [Entity L](#) > 1.

**MxN:** Representation of a [MIMO](#) system, where M is the number of the transmitting Tx antennas and N the number of the receiving Rx antennas.

**N**

**non-MIMO mode:** This term is used interchangeably to the term [Standard mode](#).

**NTP:** A networking protocol for highly accurate clock synchronization between computer systems and instruments in local area networks, or over the public internet.

**P**

**PC:** Personal computer

**PN sequence:** [PRBS generator](#)

**Power:** A term describing the signal level in the RF domain or defining the length of the I/Q vector in the baseband domain.

**PRBS generator:** Delivers pseudo-random binary sequences of differing length and duration. They are known as maximum length sequences, and are generated with the aid of ring shift registers with feedback points determined by the polynomial.

**Primary-secondary instrument mode:** Setup with two or more R&S SMW200A or one R&S SMW200A and several other signal generators such as R&S SGT or R&S SMBV that generates synchronous and time aligned signals.

The primary instrument generates and outputs a dedicated synchronization signal (Sync Out), that has to be fed into the secondary instruments.

See [Section 10.3.1, "Connecting multiple instruments in primary-secondary instrument mode"](#), on page 664.

**Product page:** A designation of the R&S SMW200A product page [www.rohde-schwarz.com/product/SMW200A.html](http://www.rohde-schwarz.com/product/SMW200A.html)

## R

**Remote access:** [Remote operation](#)

**Remote control:** The operation of the R&S SMW200A by remote control commands or programs to perform automated tests. The instrument is connected to a system controller via LAN/VXI-11, GPIB or USB using Virtual Instrument Software Architecture (VISA). The instrument is controlled either directly, or supported by instrument drivers.

**Remote device:** External device controls the R&S SMW200A in remote operation mode, see [Remote operation](#).

Synonyms: External controller, Client device

**Remote operation:** Allows you to operate the R&S SMW200A from a remote device via VNC.

Both the R&S SMW200A and the remote device are connected in a LAN.

Synonym: Remote access

**RF:** Radio Frequency

## S

**Separate sources:** Through this documentation this term is used as an abbreviation of the "System Configuration" > "Baseband Source Config" > "Separate Sources".

With separated baseband sources, the signal in each baseband can be and has to be configured separately.

**Serial number:** Unique instrument identification, provided on the rear panel of the instrument and required to build the [Computer name](#).

The serial number are the last 6 digits in the string `<stock no.>-<serial number>`, e.g. SMW200A-102030.

See [Figure 3-5](#).

**SISO:** Single Input Single Output

**Slow IQ:** Generation of signals with an artificially reduced speed, e.g. for testing of FPGA-based hardware emulators.

**Smart device:** A mobile, cordless device, such as a smart phone or tablet, capable of internet browsing.

Synonyms: Smart phone, tablet

**SSD:** Solid-state drive, see [System drive](#)

**Standard baseband:** Short designation of R&S SMW200A equipped with the options **Baseband Generator R&S SMW-B10** and Signal Routing and Main Module **R&S SMW-B13/B13T**.

**Standard mode:** This term refers to the "System Configuration" > "Mode" > "Standard" setting and is used as an abbreviation/synonym of it throughout this documentation. This mode corresponds to the former Rohde & Schwarz signal generators capabilities, like this of an R&S SMU or R&S AMU base instrument, without the MIMO Fading option R&S SMU/AMU-K74. The representation of the block diagram is "classic", as it is in the former instruments. The block diagram displays all blocks for that the required hardware and software options are installed and shows the signal flow as it is. Compare with [Advanced mode](#).

**Star configuration:** A connection scheme for several instruments that consists of one central instrument and several other instruments, all connected to the central one.

**Stream:** An I/Q stream describes the signal at the input of the "I/Q Stream Mapper" up to the output connectors of the instrument.

**Symbol Clock:** Represents the frequency and exact timing of the transmission of the individual symbols.

**Symbol Rate:** Calculated as follows:

"Symbol Rate" = "Bit Rate" / Number of bits transmitted with each symbol

**Sync signal:** In primary-secondary instrument mode, this term describes the signal generated by the primary instrument and fed to the secondary instruments. The synchronization signal is a precise signal that facilitates the time alignment between the instruments and acts as trigger signal.

**System drive:** The system drive holds the operating system, the firmware, and the stored data. It can be a hard disk drive (HDD) or a solid-state drive (SSD). Throughout this description, the system drive is referred to as internal memory or hard disk.

## T

**Trigger:** Internally generated or externally supplied signal which starts signal generation at a particular point in time.

**Trigger event:** A trigger event is caused by the received trigger signal or executed manual trigger.

## U

**UE:** User Equipment

**USBTMC:** (USB Test & Measurement Class)

A protocol built on top of USB for communication with USB devices. Using VISA library, it supports service request, triggers, and other specific operations, similar to GPIB.

**User directory:** Describes the default file storage location for user data.

In the file system, user directory is always indicated as `/var/user`.

It is physically located on the [System drive](#).

## W

**Waveform:** A file with settings provided for repeatable tests with the same test signal.

**Wideband baseband:** Short designation of R&S SMW200A equipped with the options Wideband Baseband Generator **R&S SMW-B9** and Wideband Main Module **R&S SMW-B13XT**.

## Z

**Zeroconf:** Zero-configuration, see [Avahi](#).

# Glossary: Publications and references

## Symbols

**1DC02:** Rohde & Schwarz application note "R&S®VISA"

[www.rohde-schwarz.com/appnote/1DC02](http://www.rohde-schwarz.com/appnote/1DC02)

**1EF85:** Rohde & Schwarz application note "Recording and Converting of R&S I/Q Data Files"

[www.rohde-schwarz.com/appnote/1EF85](http://www.rohde-schwarz.com/appnote/1EF85)

**1EF90:** Rohde & Schwarz application note "Speeding up Spectrum Analyzer Measurements"

[www.rohde-schwarz.com/appnote/1EF90](http://www.rohde-schwarz.com/appnote/1EF90)

**1EF108:** Rohde & Schwarz application note "NPR Measurements on Satellite Signals"

[www.rohde-schwarz.com/appnote/1EF108](http://www.rohde-schwarz.com/appnote/1EF108)

**1GP53:** Rohde & Schwarz application note "Arbitrary Waveform Sequencing with Rohde & Schwarz Vector Signal Generators"

[www.rohde-schwarz.com/appnote/1GP53](http://www.rohde-schwarz.com/appnote/1GP53)

**1GP60:** Rohde & Schwarz application note "MATLAB Toolkit for R&S® Signal Generators"

[www.rohde-schwarz.com/appnote/1GP60](http://www.rohde-schwarz.com/appnote/1GP60)

**1GP72:** Rohde & Schwarz application note "Connectivity of Rohde & Schwarz Signal Generators"

[www.rohde-schwarz.com/appnote/1GP72](http://www.rohde-schwarz.com/appnote/1GP72)

**1GP88:** Rohde & Schwarz application note "R&S®ARB Toolbox PC Software User Manual"

[www.rohde-schwarz.com/appnote/1GP88](http://www.rohde-schwarz.com/appnote/1GP88)

**1GP96:** Rohde & Schwarz application note "CDM-Toolbox Digital Modulation in a simple way"

[www.rohde-schwarz.com/appnote/1GP96](http://www.rohde-schwarz.com/appnote/1GP96)

**1GP98:** Rohde & Schwarz application note "SCPI-Recorder Test Automation at Your Fingertips"

[www.rohde-schwarz.com/appnote/1GP98](http://www.rohde-schwarz.com/appnote/1GP98)

**1GP103:** Rohde & Schwarz application note "Connecting and Interfacing with SGMA Instruments"

[www.rohde-schwarz.com/appnote/1GP103](http://www.rohde-schwarz.com/appnote/1GP103)

**1GP108:** Rohde & Schwarz application note "Generating Multiple Phase Coherent Signals – Aligned in Phase and Time"

[www.rohde-schwarz.com/appnote/1GP108](http://www.rohde-schwarz.com/appnote/1GP108)

**1GP110:** Rohde & Schwarz application note "Remote Emulation with the R&S®SMW200A Vector Signal Generator"

[www.rohde-schwarz.com/appnote/1GP110](http://www.rohde-schwarz.com/appnote/1GP110)

**1GP112:** Rohde & Schwarz white paper "Malware Protection"

[www.rohde-schwarz.com/appnote/1GP112](http://www.rohde-schwarz.com/appnote/1GP112)

**1GP141:** Rohde & Schwarz application note "Using R&S® Power Sensors with R&S®Signal Generators"

[www.rohde-schwarz.com/appnote/1GP141](http://www.rohde-schwarz.com/appnote/1GP141)

**1MA028:** Rohde & Schwarz application note "IQWizard IQ-Signal Measurement & Conversion"

[www.rohde-schwarz.com/appnote/1MA028](http://www.rohde-schwarz.com/appnote/1MA028)

**1MA074:** Rohde & Schwarz application note "RSCommander"

[www.rohde-schwarz.com/appnote/1MA074](http://www.rohde-schwarz.com/appnote/1MA074)

**1MA99:** Rohde & Schwarz application note "Guidance on Selecting and Handling Coaxial RF Connectors used with Rohde & Schwarz Test Equipment"

[www.rohde-schwarz.com/appnote/1MA99](http://www.rohde-schwarz.com/appnote/1MA99)

**1MA100:** Rohde & Schwarz application note "Test Port Adapter, R&S Interchangeable Port Connector"

[www.rohde-schwarz.com/appnote/1MA100](http://www.rohde-schwarz.com/appnote/1MA100)

**1MA196:** Rohde & Schwarz application note "R&S®Forum Application for Remote Control of Rohde & Schwarz Instruments"

[www.rohde-schwarz.com/appnote/1MA196](http://www.rohde-schwarz.com/appnote/1MA196)

**1MA208:** Rohde & Schwarz application note "Fast Remote Instrument Control with HiSLIP"

[www.rohde-schwarz.com/appnote/1MA208](http://www.rohde-schwarz.com/appnote/1MA208)

## G

**GFM336:** Rohde & Schwarz application note "Instrument Health & Utilization Monitoring"

[www.rohde-schwarz.com/appnote/GFM336](http://www.rohde-schwarz.com/appnote/GFM336)

## R

**R&S iq-tar:** Rohde & Schwarz manual "Rohde & Schwarz iq-tar File Format Specification"

For example available at:

[www.rohde-schwarz.com/manual/fsw/](http://www.rohde-schwarz.com/manual/fsw/)



## List of commands and waveform tags

:CALibration:ALL[:MEASure]?	918
:CALibration:DATA:EXPort	920
:CALibration:DATA:FACTory:DATE?	920
:CALibration:DELAy:MINutes	920
:CALibration:DELAy:SHUTdown[:STATe]	920
:CALibration:DELAy[:MEASure]?	921
:CALibration<hw>:ALL:DATE?	918
:CALibration<hw>:ALL:INFormation?	919
:CALibration<hw>:ALL:TEMP?	919
:CALibration<hw>:ALL:TIME?	919
:CALibration<hw>:CONTInueonerror	919
:CALibration<hw>:DEBUg	921
:CALibration<hw>:FREQUency:CONVerter:EXTernal?	922
:CALibration<hw>:IQModulator:LOCAl?	921
:CALibration<hw>:LOSCillator:COUPLing:LOCAl?	922
:CLOCK:INPut:FREQUency?	922
:DEVIce:PRESet	903
:DIAGnostic:INFO:OTIME?	924
:DIAGnostic:INFO:POCounT?	925
:DIAGnostic<hw>:BGINfo:CATalog?	924
:DIAGnostic<hw>:BGINfo?	924
:DIAGnostic<hw>:POINt:CATalog?	925
:DIAGnostic<hw>[:MEASure]:POINt?	925
:DISPlay:ANNotation:AMPLitude	935
:DISPlay:ANNotation:FREQUency	935
:DISPlay:ANNotation[:ALL]	936
:DISPlay:DIALog:CLOSe	937
:DISPlay:DIALog:CLOSe:ALL	937
:DISPlay:DIALog:ID?	936
:DISPlay:DIALog:OPEN	937
:DISPlay:PSAVE:HOLDoff	934
:DISPlay:PSAVE[:STATe]	934
:DISPlay:UPDate[:STATe]	935
:FORMat:BORDER	938
:FORMat:SREGister	938
:FORMat[:DATA]	938
:FPANel:KEYBoard:LAYout	944
:HCOPY:DATA?	940
:HCOPY:DEVIce:LANGuage	940
:HCOPY:FILE[:NAME]	941
:HCOPY:FILE[:NAME]:AUTO:DIRectory	942
:HCOPY:FILE[:NAME]:AUTO:DIRectory:CLEAr	942
:HCOPY:FILE[:NAME]:AUTO:FILE?	942
:HCOPY:FILE[:NAME]:AUTO:STATe	943
:HCOPY:FILE[:NAME]:AUTO?	942
:HCOPY:FILE[:NAME]:AUTO[:FILE]:DAY:STATe	943
:HCOPY:FILE[:NAME]:AUTO[:FILE]:MONTH:STATe	943

:HCOPY:FILE[:NAME]:AUTO[:FILE]:NUMBER?	943
:HCOPY:FILE[:NAME]:AUTO[:FILE]:PREFIX	944
:HCOPY:FILE[:NAME]:AUTO[:FILE]:PREFIX:STATE	944
:HCOPY:FILE[:NAME]:AUTO[:FILE]:YEAR:STATE	943
:HCOPY:IMAGe:FORMat	940
:HCOPY:REGion	941
:HCOPY[:EXECute]	941
:INITiate<hw>[:POWER]:CONTinuous	954
:KBOARD:LAYout	944
:MEMory:HFRee?	917
:MMEMory:CATalog:LENGth?	910
:MMEMory:CATalog?	910
:MMEMory:CDIRectory	910
:MMEMory:COpy	911
:MMEMory:DATA	911
:MMEMory:DATA:UNPRotected	912
:MMEMory:DCATalog:LENGth?	914
:MMEMory:DCATalog?	914
:MMEMory:DELeTe	914
:MMEMory:LOAD:STATE	914
:MMEMory:MDIRectory	915
:MMEMory:MOVE	915
:MMEMory:MSIS	915
:MMEMory:RDIRectory	916
:MMEMory:RDIRectory:RECURSive	916
:MMEMory:STORE:STATE	916
:OUTPut:ALL[:STATE]	945
:OUTPut:USER<ch>:DIRectioN	1009
:OUTPut:USER<ch>:SIGNal	1012
:OUTPut:USER<ch>:TRIGger[:IMMediate]	1013
:OUTPut<hw>:AFIXed:RANGe:LOWer?	947
:OUTPut<hw>:AFIXed:RANGe:UPPer?	947
:OUTPut<hw>:AMODE	946
:OUTPut<hw>:BLANK:LIST:STATE	947
:OUTPut<hw>:IMPedance?	947
:OUTPut<hw>:PROTection:CLEar	948
:OUTPut<hw>:PROTection:STATE	948
:OUTPut<hw>:PROTection:TRIPped?	948
:OUTPut<hw>:TM<ch>:DIRectioN	1008
:OUTPut<hw>:TM<ch>:SIGNal	1010
:OUTPut<hw>[:STATE]	945
:OUTPut<hw>[:STATE]:PON	946
:READ<ch>[:POWER]?	955
:SCONfiguration:APPLY	980
:SCONfiguration:BASEband:SOURce	978
:SCONfiguration:BBBW	978
:SCONfiguration:CABW?	979
:SCONfiguration:DIQ:BBMM1:CHANnels	979
:SCONfiguration:DIQ:BBMM2:CHANnels	979
:SCONfiguration:DUPLicate[:STReam]	980

:SCONfiguration:EXTErnal:ACONnect.....	985
:SCONfiguration:EXTErnal:BBMM<ch>:DIRection?.....	986
:SCONfiguration:EXTErnal:BBMM<ch>:INAME?.....	987
:SCONfiguration:EXTErnal:BBMM<ch>:IQConnection:STATe?.....	987
:SCONfiguration:EXTErnal:BBMM<ch>:RCONnection:STATe?.....	987
:SCONfiguration:EXTErnal:BBMM<ch>:REMote:CONNect.....	993
:SCONfiguration:EXTErnal:BBMM<ch>:REMote:DETEct?.....	992
:SCONfiguration:EXTErnal:BBMM<ch>:REMote:DISConnect.....	994
:SCONfiguration:EXTErnal:BBMM<ch>:REMote:ICONnect.....	993
:SCONfiguration:EXTErnal:BBMM<ch>:REMote:INFO?.....	993
:SCONfiguration:EXTErnal:BBMM<ch>:REMote:INITIALIZation:FILE.....	995
:SCONfiguration:EXTErnal:BBMM<ch>:REMote:ISELect.....	992
:SCONfiguration:EXTErnal:BBMM<ch>:REMote:SEND.....	995
:SCONfiguration:EXTErnal:BBMM<ch>:RF:COUPLing.....	988
:SCONfiguration:EXTErnal:BBMM<ch>:RF:FREQUency.....	988
:SCONfiguration:EXTErnal:BBMM<ch>:RF:FREQUency:OFFSet.....	988
:SCONfiguration:EXTErnal:BBMM<ch>:RF:POWEr.....	989
:SCONfiguration:EXTErnal:BBMM<ch>:RF:POWEr:OFFSet.....	989
:SCONfiguration:EXTErnal:BBMM<ch>:RF:STATe.....	990
:SCONfiguration:EXTErnal:CODer<ch>:DIRection?.....	986
:SCONfiguration:EXTErnal:CODer<ch>:INAME?.....	987
:SCONfiguration:EXTErnal:CODer<ch>:IQConnection:STATe?.....	987
:SCONfiguration:EXTErnal:CODer<ch>:RCONnection:STATe?.....	987
:SCONfiguration:EXTErnal:CODer<ch>:REMote:CONNect.....	993
:SCONfiguration:EXTErnal:CODer<ch>:REMote:DETEct?.....	992
:SCONfiguration:EXTErnal:CODer<ch>:REMote:DISConnect.....	994
:SCONfiguration:EXTErnal:CODer<ch>:REMote:ICONnect.....	993
:SCONfiguration:EXTErnal:CODer<ch>:REMote:INFO?.....	993
:SCONfiguration:EXTErnal:CODer<ch>:REMote:INITIALIZation:FILE.....	995
:SCONfiguration:EXTErnal:CODer<ch>:REMote:ISELect.....	992
:SCONfiguration:EXTErnal:CODer<ch>:REMote:SEND.....	995
:SCONfiguration:EXTErnal:DISPlay.....	984
:SCONfiguration:EXTErnal:FADer<ch>:DIRection?.....	986
:SCONfiguration:EXTErnal:FADer<ch>:INAME?.....	987
:SCONfiguration:EXTErnal:FADer<ch>:IQConnection:STATe?.....	987
:SCONfiguration:EXTErnal:FADer<ch>:RCONnection:STATe?.....	987
:SCONfiguration:EXTErnal:FADer<ch>:REMote:CONNect.....	993
:SCONfiguration:EXTErnal:FADer<ch>:REMote:DETEct?.....	992
:SCONfiguration:EXTErnal:FADer<ch>:REMote:DISConnect.....	994
:SCONfiguration:EXTErnal:FADer<ch>:REMote:ICONnect.....	993
:SCONfiguration:EXTErnal:FADer<ch>:REMote:INFO?.....	993
:SCONfiguration:EXTErnal:FADer<ch>:REMote:INITIALIZation:FILE.....	995
:SCONfiguration:EXTErnal:FADer<ch>:REMote:ISELect.....	992
:SCONfiguration:EXTErnal:FADer<ch>:REMote:SEND.....	995
:SCONfiguration:EXTErnal:FADer<ch>:RF:COUPLing.....	988
:SCONfiguration:EXTErnal:FADer<ch>:RF:FREQUency.....	988
:SCONfiguration:EXTErnal:FADer<ch>:RF:FREQUency:OFFSet.....	988
:SCONfiguration:EXTErnal:FADer<ch>:RF:POWEr.....	989
:SCONfiguration:EXTErnal:FADer<ch>:RF:POWEr:OFFSet.....	989
:SCONfiguration:EXTErnal:FADer<ch>:RF:STATe.....	990

:SCONfiguration:EXTernal:IQOutput<ch>:CONNECTIONS:CHECK?	996
:SCONfiguration:EXTernal:IQOutput<ch>:DIRection?	986
:SCONfiguration:EXTernal:IQOutput<ch>:INAMe?	987
:SCONfiguration:EXTernal:IQOutput<ch>:RCONnection:STATe?	987
:SCONfiguration:EXTernal:IQOutput<ch>:REMote:CONNect	993
:SCONfiguration:EXTernal:IQOutput<ch>:REMote:DISConnect	994
:SCONfiguration:EXTernal:IQOutput<ch>:REMote:ICONnect	993
:SCONfiguration:EXTernal:IQOutput<ch>:REMote:INFO?	994
:SCONfiguration:EXTernal:IQOutput<ch>:REMote:INITialization:FILE	995
:SCONfiguration:EXTernal:IQOutput<ch>:REMote:ISElect	992
:SCONfiguration:EXTernal:IQOutput<ch>:REMote:SEND	995
:SCONfiguration:EXTernal:IQOutput<ch>:RF:COUPLing	988
:SCONfiguration:EXTernal:IQOutput<ch>:RF:FREQUency	988
:SCONfiguration:EXTernal:IQOutput<ch>:RF:FREQUency:OFFSet	988
:SCONfiguration:EXTernal:IQOutput<ch>:RF:POWer	989
:SCONfiguration:EXTernal:IQOutput<ch>:RF:POWer:OFFSet	989
:SCONfiguration:EXTernal:IQOutput<ch>:RF:STATe	990
:SCONfiguration:EXTernal:PBEHaviour	985
:SCONfiguration:EXTernal:REMote:ADD	991
:SCONfiguration:EXTernal:REMote:CLEan	995
:SCONfiguration:EXTernal:REMote:CONNect[:ALL]	985
:SCONfiguration:EXTernal:REMote:DISConnect[:ALL]	985
:SCONfiguration:EXTernal:REMote:INITialization:CATalog?	994
:SCONfiguration:EXTernal:REMote:LIST?	991
:SCONfiguration:EXTernal:REMote:PURGe	995
:SCONfiguration:EXTernal:REMote:REName	992
:SCONfiguration:EXTernal:REMote:SCAN	990
:SCONfiguration:EXTernal:REMote:SCAN:STATe?	990
:SCONfiguration:EXTernal:RF<ch>:DIRection?	986
:SCONfiguration:EXTernal:RF<ch>:INAMe?	987
:SCONfiguration:EXTernal:RF<ch>:RCONnection:STATe?	987
:SCONfiguration:EXTernal:RF<ch>:REMote:CONNect	993
:SCONfiguration:EXTernal:RF<ch>:REMote:DISConnect	994
:SCONfiguration:EXTernal:RF<ch>:REMote:ICONnect	993
:SCONfiguration:EXTernal:RF<ch>:REMote:INFO?	994
:SCONfiguration:EXTernal:RF<ch>:REMote:INITialization:FILE	995
:SCONfiguration:EXTernal:RF<ch>:REMote:ISElect	992
:SCONfiguration:EXTernal:RF<ch>:REMote:SEND	995
:SCONfiguration:EXTernal:RF<ch>:RF:COUPLing	988
:SCONfiguration:EXTernal:RF<ch>:RF:FREQUency	988
:SCONfiguration:EXTernal:RF<ch>:RF:FREQUency:OFFSet	988
:SCONfiguration:EXTernal:RF<ch>:RF:POWer	989
:SCONfiguration:EXTernal:RF<ch>:RF:POWer:OFFSet	989
:SCONfiguration:EXTernal:RF<ch>:RF:STATe	990
:SCONfiguration:FADing	976
:SCONfiguration:MIMO:SUBSet	977
:SCONfiguration:MODE	975
:SCONfiguration:MULTIinstrument:MODE	974
:SCONfiguration:MULTIinstrument:STATe	974
:SCONfiguration:MULTIinstrument:TRIGger:SYNChronization?	974

:SCONfiguration:OUTPut:MAPPING:BBMM<ch>:CHANnel<di>:MODE.....	981
:SCONfiguration:OUTPut:MAPPING:BBMM<ch>:CHANnel<di>:STReam<st>:STATe.....	981
:SCONfiguration:OUTPut:MAPPING:BBMM<ch>:MODE.....	981
:SCONfiguration:OUTPut:MAPPING:BBMM<ch>:STReam<st>:STATe.....	981
:SCONfiguration:OUTPut:MAPPING:FADer<ch>:MODE.....	981
:SCONfiguration:OUTPut:MAPPING:FADer<ch>:STReam<st>:STATe.....	981
:SCONfiguration:OUTPut:MAPPING:IQOutput<ch>:MODE.....	981
:SCONfiguration:OUTPut:MAPPING:IQOutput<ch>:STReam<st>:STATe.....	981
:SCONfiguration:OUTPut:MAPPING:RF<ch>:MODE.....	981
:SCONfiguration:OUTPut:MAPPING:RF<ch>:STReam<st>:STATe.....	981
:SCONfiguration:OUTPut:MAPPING:STReam<st>:FOFFset.....	981
:SCONfiguration:OUTPut:MAPPING:STReam<st>:POFFset.....	982
:SCONfiguration:OUTPut:MODE.....	976
:SCONfiguration:PRESet.....	975
:SCONfiguration:RFALignment:ALIGn.....	1000
:SCONfiguration:RFALignment:SETup:CATalog?.....	999
:SCONfiguration:RFALignment:SETup:FILE.....	999
:SCONfiguration:RFALignment:SETup:FILE:PREDefined.....	998
:SCONfiguration:RFALignment:SETup:INFO:CALibration:AGE?.....	1001
:SCONfiguration:RFALignment:SETup:INFO:CALibration:DATE?.....	1000
:SCONfiguration:RFALignment:SETup:INFO:CALibration:FREQuency:LIST:VALues?.....	1002
:SCONfiguration:RFALignment:SETup:INFO:CALibration:FREQuency:MODE?.....	1002
:SCONfiguration:RFALignment:SETup:INFO:CALibration:FREQuency:RANGe:LOWer?.....	1003
:SCONfiguration:RFALignment:SETup:INFO:CALibration:FREQuency:RANGe:UPPer?.....	1003
:SCONfiguration:RFALignment:SETup:INFO:CALibration:FREQuency:STEP?.....	1003
:SCONfiguration:RFALignment:SETup:INFO:CALibration:LOCoupling?.....	1004
:SCONfiguration:RFALignment:SETup:INFO:CALibration:PARAMeters?.....	1001
:SCONfiguration:RFALignment:SETup:INFO:CALibration:POWER:LIST:VALues?.....	1002
:SCONfiguration:RFALignment:SETup:INFO:CALibration:POWER:MODE?.....	1002
:SCONfiguration:RFALignment:SETup:INFO:CALibration:POWER:RANGe:LOWer?.....	1003
:SCONfiguration:RFALignment:SETup:INFO:CALibration:POWER:RANGe:UPPer?.....	1003
:SCONfiguration:RFALignment:SETup:INFO:CALibration:POWER:STEP?.....	1003
:SCONfiguration:RFALignment:SETup:INFO:CALibration:TEMPerature:OFFSet?.....	1001
:SCONfiguration:RFALignment:SETup:INFO:CALibration:TIME?.....	1001
:SCONfiguration:RFALignment:SETup:INFO:WIRing:LO:CONStellation?.....	1004
:SCONfiguration:RFALignment:SETup:INFO:WIRing:LO:SOURce?.....	1004
:SCONfiguration:RFALignment:SETup:INFO:WIRing:REF:SOURce?.....	1005
:SCONfiguration:RFALignment:SETup:PREDefined:CATalog?.....	998
:SCONfiguration:RFALignment:SETup:STATus?.....	999
:SCONfiguration:RFALignment:STATe.....	1000
:SENSe<ch>:UNIT[:POWER].....	956
:SENSe<ch>[:POWER]:APERture:DEFault:STATe.....	956
:SENSe<ch>[:POWER]:APERture:TIME.....	956
:SENSe<ch>[:POWER]:CORRection:SPDevice:LIST?.....	957
:SENSe<ch>[:POWER]:CORRection:SPDevice:SElect.....	957
:SENSe<ch>[:POWER]:CORRection:SPDevice:STATe.....	957
:SENSe<ch>[:POWER]:DISPlay:PERManent:PRIOriety.....	957
:SENSe<ch>[:POWER]:DISPlay:PERManent:STATe.....	958
:SENSe<ch>[:POWER]:FILTer:LENGth:AUTO?.....	958
:SENSe<ch>[:POWER]:FILTer:LENGth[:USER].....	958

:SENSe<ch>[:POWer]:FILTer:NSRatio.....	959
:SENSe<ch>[:POWer]:FILTer:NSRatio:MTIME.....	959
:SENSe<ch>[:POWer]:FILTer:SONCe.....	959
:SENSe<ch>[:POWer]:FILTer:TYPE.....	960
:SENSe<ch>[:POWer]:FREQUency.....	960
:SENSe<ch>[:POWer]:LOGGing:STATe.....	961
:SENSe<ch>[:POWer]:OFFSet.....	961
:SENSe<ch>[:POWer]:OFFSet:STATe.....	961
:SENSe<ch>[:POWer]:SNUMber?.....	962
:SENSe<ch>[:POWer]:SOURce.....	962
:SENSe<ch>[:POWer]:STATus[:DEVice]?.....	962
:SENSe<ch>[:POWer]:SVERsion?.....	963
:SENSe<ch>[:POWer]:TYPE?.....	963
:SENSe<ch>[:POWer]:ZERO.....	963
:SLISt:CLEar:LAN.....	953
:SLISt:CLEar:USB.....	953
:SLISt:CLEar[:ALL].....	954
:SLISt:ELEMent<ch>:MAPPing.....	954
:SLISt:SCAN:LSENSor.....	952
:SLISt:SCAN:USENSor.....	953
:SLISt:SCAN[:STATe].....	952
:SLISt:SENSor:MAP.....	954
:SLISt[:LIST]?.....	952
:SOURce<hw>:PGENerator:SET:GLB:CONNectors.....	1262
:SOURce<hw>:PRESet.....	904
:SOURce<hw>:RFALignment:CALibrated:FREQUency?.....	1285
:SOURce<hw>:RFALignment:CALibrated:POWer:PEP?.....	1285
:SOURce<hw>:RFALignment:CORRection:IQDelay?.....	1287
:SOURce<hw>:RFALignment:CORRection:LEVel?.....	1286
:SOURce<hw>:RFALignment:CORRection:PHASE?.....	1286
:SOURce<hw>:RFALignment:DATTenuation?.....	1286
:SOURce<hw>:RFALignment:FOFFset?.....	1286
:STATus:OPERation:CONDition?.....	1326
:STATus:OPERation:ENABLE.....	1327
:STATus:OPERation:NTRansition.....	1327
:STATus:OPERation:PTRansition.....	1327
:STATus:OPERation[:EVENT].....	1327
:STATus:PRESet.....	1328
:STATus:QUESTionable:CONDition.....	1328
:STATus:QUESTionable:ENABLE.....	1328
:STATus:QUESTionable:NTRansition.....	1329
:STATus:QUESTionable:PTRansition.....	1329
:STATus:QUESTionable[:EVENT].....	1328
:STATus:QUEEue[:NEXT]?.....	1329
:SYSTem:BIOS:VERsion?.....	1323
:SYSTem:COMMunicate:GPIB:LTERminator.....	1307
:SYSTem:COMMunicate:GPIB:RESource?.....	1307
:SYSTem:COMMunicate:GPIB[:SELF]:ADDReSS.....	1307
:SYSTem:COMMunicate:HISLip:RESource?.....	1307
:SYSTem:COMMunicate:NETWork:IPADdress.....	1308

:SYSTem:COMMunicate:NETWork:IPADdress:MODE.....	1308
:SYSTem:COMMunicate:NETWork:MACAddress.....	1308
:SYSTem:COMMunicate:NETWork:RESource?.....	1308
:SYSTem:COMMunicate:NETWork:REStart.....	1309
:SYSTem:COMMunicate:NETWork:STATus?.....	1309
:SYSTem:COMMunicate:NETWork[:COMMOn]:DOMain.....	1309
:SYSTem:COMMunicate:NETWork[:COMMOn]:HOSTname.....	1309
:SYSTem:COMMunicate:NETWork[:COMMOn]:WORKgroup.....	1310
:SYSTem:COMMunicate:NETWork[:IPADdress]:DNS.....	1310
:SYSTem:COMMunicate:NETWork[:IPADdress]:GATeway.....	1310
:SYSTem:COMMunicate:NETWork[:IPADdress]:SUBNet:MASK.....	1310
:SYSTem:COMMunicate:SERial:BAUD.....	1310
:SYSTem:COMMunicate:SERial:PARity.....	1311
:SYSTem:COMMunicate:SERial:RESource?.....	1311
:SYSTem:COMMunicate:SERial:SBITs.....	1311
:SYSTem:COMMunicate:SOCKet:RESource?.....	1311
:SYSTem:COMMunicate:USB:RESource?.....	1312
:SYSTem:DATE.....	1321
:SYSTem:DFPPrint.....	1324
:SYSTem:DLOCK.....	1303
:SYSTem:ERRor:ALL?.....	1300
:SYSTem:ERRor:CODE:ALL?.....	1301
:SYSTem:ERRor:CODE[:NEXT]?.....	1301
:SYSTem:ERRor:COUNT?.....	1301
:SYSTem:ERRor:GNEXT?.....	1302
:SYSTem:ERRor:HISTory:CLEar.....	1303
:SYSTem:ERRor:STATic?.....	1303
:SYSTem:ERRor[:NEXT]?.....	1302
:SYSTem:FPReset.....	904
:SYSTem:HELP:EXPort.....	1312
:SYSTem:IDENtification.....	1312
:SYSTem:IDENtification:PRESet.....	1312
:SYSTem:INFormaTion:SCPI.....	1314
:SYSTem:IRESpOse.....	1313
:SYSTem:KLOCK.....	1303
:SYSTem:LANGUage.....	1313
:SYSTem:LOCK:OWNer?.....	1305
:SYSTem:LOCK:RELease:ALL.....	1305
:SYSTem:LOCK:REQUest[:EXCLusive]?.....	1305
:SYSTem:MMEMory:PATH:USER?.....	1324
:SYSTem:NINFormaTion?.....	1304
:SYSTem:NTP:HOSTname.....	1321
:SYSTem:NTP:STATe.....	1322
:SYSTem:OPTion:TRlAl:LIST?.....	1321
:SYSTem:OPTion:TRlAl[:STATe].....	1321
:SYSTem:ORESpOse.....	1313
:SYSTem:OSYStem?.....	1324
:SYSTem:PRESet.....	904
:SYSTem:PROTect<ch>[:STATe].....	1306
:SYSTem:RCL.....	1306

:SYSTem:REBoot.....	1325
:SYSTem:REStArt.....	1325
:SYSTem:SAV.....	1305
:SYSTem:SECurity:NETWork:AVAHi[:STATe].....	1314
:SYSTem:SECurity:NETWork:FTP[:STATe].....	1314
:SYSTem:SECurity:NETWork:HTTIP[:STATe].....	1314
:SYSTem:SECurity:NETWork:RAW[:STATe].....	1315
:SYSTem:SECurity:NETWork:REMSupport[:STATe].....	1315
:SYSTem:SECurity:NETWork:RPC[:STATe].....	1315
:SYSTem:SECurity:NETWork:SMB[:STATe].....	1316
:SYSTem:SECurity:NETWork:SOE[:STATe].....	1316
:SYSTem:SECurity:NETWork:SSH[:STATe].....	1316
:SYSTem:SECurity:NETWork:SWUPdate[:STATe].....	1316
:SYSTem:SECurity:NETWork:VNC[:STATe].....	1317
:SYSTem:SECurity:NETWork[:STATe].....	1317
:SYSTem:SECurity:SANitize[:STATe].....	1317
:SYSTem:SECurity:VOLMode[:STATe].....	1318
:SYSTem:SHUTdown.....	1325
:SYSTem:SPECification:IDENtification:CATalog?.....	1319
:SYSTem:SPECification:PARAmeter?.....	1319
:SYSTem:SPECification:VERSion.....	1318
:SYSTem:SPECification:VERSion:CATalog?.....	1319
:SYSTem:SPECification:VERSion:FACTory?.....	1320
:SYSTem:SPECification?.....	1318
:SYSTem:SRData?.....	1320
:SYSTem:STARtup:COMPLete?.....	1320
:SYSTem:TIME.....	1322
:SYSTem:TIME:PROTOcol.....	1323
:SYSTem:TIME:ZONE.....	1322
:SYSTem:TIME:ZONE:CATalog?.....	1322
:SYSTem:ULOCK.....	1304
:SYSTem:UPTime?.....	1323
:SYSTem:VERSion?.....	1323
:SYSTem:WAIT.....	1325
:TEST:BASeband:LOG?.....	1331
:TEST:BASeband?.....	1331
:TEST:BB:BNC:CONNection?.....	1331
:TEST:BB:BNC:DEStination.....	1331
:TEST:BB:BNC:LOG?.....	1332
:TEST:BB:BNC:SOURce.....	1332
:TEST:BB:GENerator:ARBITrary.....	1333
:TEST:BB:GENerator:FREQuency<ch>.....	1333
:TEST:BB:GENerator:GAIN.....	1333
:TEST:BB:GENerator:SOURce.....	1333
:TEST:BB:GENerator:STATe.....	1334
:TEST:PIXel:COLor.....	1335
:TEST:PIXel:GRADient.....	1335
:TEST:PIXel:POINtsize.....	1336
:TEST:PIXel:RGBA.....	1336
:TEST:PIXel:TEXT.....	1336



:TEST:PIXel:WINDow.....	1336
:TEST<hw>:ALL:RESult?.....	1335
:TEST<hw>:ALL:START.....	1335
:TEST<hw>:DIRect:BLOCK:READ?.....	1334
:TEST<hw>:DIRect:BLOCK:WRITe.....	1334
:TRIGger<hw>:FSWeep:SOURce.....	1337
:TRIGger<hw>:FSWeep[:IMMediate].....	1338
:TRIGger<hw>:LFFSweep.....	1339
:TRIGger<hw>:LFFSweep:IMMediate.....	1338
:TRIGger<hw>:LFFSweep:SOURce.....	1337
:TRIGger<hw>:PSWeep:SOURce.....	1337
:TRIGger<hw>:PSWeep[:IMMediate].....	1339
:TRIGger<hw>[:SWEep]:SOURce.....	1337
:TRIGger<hw>[:SWEep][:IMMediate].....	1339
:UNIT:ANGLE.....	1340
:UNIT:POWer.....	1340
:UNIT:VELocity.....	1340
[:SOURce]:BB:GRAPhics:ADD.....	1176
[:SOURce]:BB:GRAPhics:CLOSe.....	1175
[:SOURce]:BB:GRAPhics:FFTFscale.....	1177
[:SOURce]:BB:GRAPhics:FFTLen.....	1177
[:SOURce]:BB:GRAPhics:SOURce.....	1176
[:SOURce]:BB:GRAPhics:SOURce:MUX.....	1176
[:SOURce]:BB:IMPairment:BBMM<ch>:DELay.....	1170
[:SOURce]:BB:IMPairment:BBMM<ch>:IQRatio[:MAGNitude].....	1171
[:SOURce]:BB:IMPairment:BBMM<ch>:LEAKage:I.....	1171
[:SOURce]:BB:IMPairment:BBMM<ch>:LEAKage:Q.....	1171
[:SOURce]:BB:IMPairment:BBMM<ch>:POFFset.....	1173
[:SOURce]:BB:IMPairment:BBMM<ch>:QUADrature[:ANGLE].....	1172
[:SOURce]:BB:IMPairment:BBMM<ch>:SKEW.....	1172
[:SOURce]:BB:IMPairment:BBMM<ch>:STATe.....	1172
[:SOURce]:BB:IMPairment:FADer<ch>:DELay.....	1170
[:SOURce]:BB:IMPairment:FADer<ch>:IQRatio[:MAGNitude].....	1171
[:SOURce]:BB:IMPairment:FADer<ch>:LEAKage:I.....	1171
[:SOURce]:BB:IMPairment:FADer<ch>:LEAKage:Q.....	1171
[:SOURce]:BB:IMPairment:FADer<ch>:POFFset.....	1173
[:SOURce]:BB:IMPairment:FADer<ch>:QUADrature[:ANGLE].....	1172
[:SOURce]:BB:IMPairment:FADer<ch>:SKEW.....	1172
[:SOURce]:BB:IMPairment:FADer<ch>:STATe.....	1173
[:SOURce]:BB:IMPairment:IQOutput<ch>:DELay.....	1170
[:SOURce]:BB:IMPairment:IQOutput<ch>:IQRatio[:MAGNitude].....	1171
[:SOURce]:BB:IMPairment:IQOutput<ch>:LEAKage:I.....	1171
[:SOURce]:BB:IMPairment:IQOutput<ch>:LEAKage:Q.....	1171
[:SOURce]:BB:IMPairment:IQOutput<ch>:POFFset.....	1173
[:SOURce]:BB:IMPairment:IQOutput<ch>:QUADrature[:ANGLE].....	1172
[:SOURce]:BB:IMPairment:IQOutput<ch>:SKEW.....	1172
[:SOURce]:BB:IMPairment:IQOutput<ch>:STATe.....	1173
[:SOURce]:BB:IMPairment:RF<ch>:DELay.....	1170
[:SOURce]:BB:IMPairment:RF<ch>:IQRatio[:MAGNitude].....	1171
[:SOURce]:BB:IMPairment:RF<ch>:LEAKage:I.....	1171

[[:SOURce]:BB:IMPairment:RF<ch>:LEAKage:Q.....	1171
[[:SOURce]:BB:IMPairment:RF<ch>:POFFset.....	1173
[[:SOURce]:BB:IMPairment:RF<ch>:QUADrature[:ANGLE].....	1172
[[:SOURce]:BB:IMPairment:RF<ch>:SKEW.....	1172
[[:SOURce]:BB:IMPairment:RF<ch>:STATe.....	1173
[[:SOURce]:BB:MEASurement:POWer:ABORt.....	1183
[[:SOURce]:BB:MEASurement:POWer:ACQuisition.....	1180
[[:SOURce]:BB:MEASurement:POWer:ADD.....	1180
[[:SOURce]:BB:MEASurement:POWer:CHANge.....	1183
[[:SOURce]:BB:MEASurement:POWer:DELeTe.....	1183
[[:SOURce]:BB:MEASurement:POWer:DURation.....	1182
[[:SOURce]:BB:MEASurement:POWer:EXECute.....	1183
[[:SOURce]:BB:MEASurement:POWer:GSOurce.....	1180
[[:SOURce]:BB:MEASurement:POWer:INDex.....	1182
[[:SOURce]:BB:MEASurement:POWer:OUTPut.....	1179
[[:SOURce]:BB:MEASurement:POWer:PEAK?.....	1181
[[:SOURce]:BB:MEASurement:POWer:PROGress?.....	1182
[[:SOURce]:BB:MEASurement:POWer:RMODE.....	1180
[[:SOURce]:BB:MEASurement:POWer:RMS?.....	1181
[[:SOURce]:BB:MEASurement:POWer:RSTate?.....	1181
[[:SOURce]:BB:MEASurement:POWer:SOURce.....	1179
[[:SOURce]:CORRection:CSET:CATalog?.....	1190
[[:SOURce]:CORRection:CSET:DELeTe.....	1190
[[:SOURce]:INPut:USER:CLOCK:IMPedance.....	1014
[[:SOURce]:INPut:USER:CLOCK:LEVel.....	1013
[[:SOURce]:INPut:USER:CLOCK:SLOPe.....	1014
[[:SOURce]:INPut:USER:PULM:LEVel.....	1014
[[:SOURce]:INPut:USER:TRIGger:IMPedance.....	1014
[[:SOURce]:INPut:USER:TRIGger:LEVel.....	1013
[[:SOURce]:INPut:USER:TRIGger:SLOPe.....	1014
[[:SOURce]:INPut:USER<ch>:DIRection.....	1009
[[:SOURce]:INPut:USER<ch>:SIGNal.....	1011
[[:SOURce]:IQ:OUTPut:DIGital:BBMM<ch>:CDEvice?.....	1222
[[:SOURce]:IQ:OUTPut:DIGital:BBMM<ch>:CHANnel<st0>:NAME.....	1225
[[:SOURce]:IQ:OUTPut:DIGital:BBMM<ch>:CHANnel<st0>:POWer:LEVel.....	1223
[[:SOURce]:IQ:OUTPut:DIGital:BBMM<ch>:CHANnel<st0>:POWer:LEVel.....	1226
[[:SOURce]:IQ:OUTPut:DIGital:BBMM<ch>:CHANnel<st0>:POWer:PEP.....	1222
[[:SOURce]:IQ:OUTPut:DIGital:BBMM<ch>:CHANnel<st0>:POWer:PEP.....	1226
[[:SOURce]:IQ:OUTPut:DIGital:BBMM<ch>:CHANnel<st0>:SRATe.....	1226
[[:SOURce]:IQ:OUTPut:DIGital:BBMM<ch>:CHANnel<st0>:STATe.....	1227
[[:SOURce]:IQ:OUTPut:DIGital:BBMM<ch>:GDELay:CSTate.....	1224
[[:SOURce]:IQ:OUTPut:DIGital:BBMM<ch>:INTerface.....	1220
[[:SOURce]:IQ:OUTPut:DIGital:BBMM<ch>:OFLow:HOLD:RESet.....	1224
[[:SOURce]:IQ:OUTPut:DIGital:BBMM<ch>:OFLow:HOLD:STATe?.....	1225
[[:SOURce]:IQ:OUTPut:DIGital:BBMM<ch>:OFLow:STATe?.....	1224
[[:SOURce]:IQ:OUTPut:DIGital:BBMM<ch>:PON.....	1220
[[:SOURce]:IQ:OUTPut:DIGital:BBMM<ch>:POWer:LEVel.....	1223
[[:SOURce]:IQ:OUTPut:DIGital:BBMM<ch>:POWer:PEP.....	1222
[[:SOURce]:IQ:OUTPut:DIGital:BBMM<ch>:POWer:STEP:MODE.....	1223
[[:SOURce]:IQ:OUTPut:DIGital:BBMM<ch>:POWer:STEP[:INCRement].....	1224

[:SOURce]:IQ:OUTPut:DiGital:BBMM<ch>:POWer:VIA.....	1222
[:SOURce]:IQ:OUTPut:DiGital:BBMM<ch>:SLOW:STATe.....	1220
[:SOURce]:IQ:OUTPut:DiGital:BBMM<ch>:SRATe.....	1221
[:SOURce]:IQ:OUTPut:DiGital:BBMM<ch>:SRATe:COMMon:STATe.....	1225
[:SOURce]:IQ:OUTPut:DiGital:BBMM<ch>:SRATe:MAX?.....	1227
[:SOURce]:IQ:OUTPut:DiGital:BBMM<ch>:SRATe:SOURce.....	1220
[:SOURce]:IQ:OUTPut:DiGital:BBMM<ch>:SRATe:SUM?.....	1227
[:SOURce]:IQ:OUTPut:DiGital:BBMM<ch>:STATe.....	1219
[:SOURce]:IQ:OUTPut:DiGital:FADer<ch>:CDEvice?.....	1222
[:SOURce]:IQ:OUTPut:DiGital:FADer<ch>:INTerface.....	1220
[:SOURce]:IQ:OUTPut:DiGital:FADer<ch>:OFLow:HOLD:RESet.....	1224
[:SOURce]:IQ:OUTPut:DiGital:FADer<ch>:OFLow:HOLD:STATe?.....	1225
[:SOURce]:IQ:OUTPut:DiGital:FADer<ch>:OFLow:STATe?.....	1224
[:SOURce]:IQ:OUTPut:DiGital:FADer<ch>:PON.....	1220
[:SOURce]:IQ:OUTPut:DiGital:FADer<ch>:POWer:LEVel.....	1223
[:SOURce]:IQ:OUTPut:DiGital:FADer<ch>:POWer:PEP.....	1222
[:SOURce]:IQ:OUTPut:DiGital:FADer<ch>:POWer:STEP:MODE.....	1223
[:SOURce]:IQ:OUTPut:DiGital:FADer<ch>:POWer:STEP[:INCRement].....	1224
[:SOURce]:IQ:OUTPut:DiGital:FADer<ch>:POWer:VIA.....	1222
[:SOURce]:IQ:OUTPut:DiGital:FADer<ch>:SRATe.....	1221
[:SOURce]:IQ:OUTPut:DiGital:FADer<ch>:SRATe:SOURce.....	1220
[:SOURce]:IQ:OUTPut:DiGital:FADer<ch>:STATe.....	1219
[:SOURce]:LFOutput<ch>:BANDwidth?.....	1230
[:SOURce]:LFOutput<ch>:OFFSet.....	1232
[:SOURce]:LFOutput<ch>:SOURce.....	1233
[:SOURce]:LFOutput<ch>:SOURce:PATH.....	1233
[:SOURce]:LFOutput<ch>:VOLTage.....	1233
[:SOURce]:LFOutput<ch>[:STATe].....	1232
[:SOURce]:OCCupy:OPTion.....	1261
[:SOURce]:OCCupy:OPTion:CATalog?.....	1261
[:SOURce]:OCCupy:OPTion:RENew<ch>.....	1261
[:SOURce]:PM<ch>[:DEviation].....	1051
[:SOURce]:POWer:WIGNore.....	1280
[:SOURce]:ROSCillator:EXTernal:FREQuency.....	1282
[:SOURce]:ROSCillator:EXTernal:FREQuency:VARIable.....	1282
[:SOURce]:ROSCillator:EXTernal:MLRange?.....	1283
[:SOURce]:ROSCillator:EXTernal:NSBandwidth?.....	1284
[:SOURce]:ROSCillator:EXTernal:RFOF[:STATe].....	1282
[:SOURce]:ROSCillator:EXTernal:SBANDwidth.....	1283
[:SOURce]:ROSCillator:OUTPut:FREQuency:MODE.....	1284
[:SOURce]:ROSCillator:SOURce.....	1282
[:SOURce]:ROSCillator[:INTernal]:ADJust:VALue.....	1284
[:SOURce]:ROSCillator[:INTernal]:ADJust[:STATe].....	1284
[:SOURce<hw>]:AM:DEPTH:SUM.....	1040
[:SOURce<hw>]:AM:DEviation:MODE.....	1040
[:SOURce<hw>]:AM:RATio.....	1041
[:SOURce<hw>]:AM<ch>:SENSitivity.....	1041
[:SOURce<hw>]:AM<ch>:SOURce.....	1039
[:SOURce<hw>]:AM<ch>:STATe.....	1039
[:SOURce<hw>]:AM<ch>[:DEPTH].....	1040

[SOURce<hw>]:AWGN:BRATe.....	1022
[SOURce<hw>]:AWGN:BWIDth.....	1020
[SOURce<hw>]:AWGN:BWIDth:NOISe?.....	1021
[SOURce<hw>]:AWGN:BWIDth:RATio.....	1021
[SOURce<hw>]:AWGN:CMODE[:STATe].....	1020
[SOURce<hw>]:AWGN:CNRatio.....	1022
[SOURce<hw>]:AWGN:DISP:MODE.....	1021
[SOURce<hw>]:AWGN:ENRatio.....	1023
[SOURce<hw>]:AWGN:FREQuency:CENTer:OFFSet.....	1025
[SOURce<hw>]:AWGN:FREQuency:RESult?.....	1025
[SOURce<hw>]:AWGN:FREQuency:TARGet.....	1025
[SOURce<hw>]:AWGN:MODE.....	1020
[SOURce<hw>]:AWGN:POWer:CARRier.....	1023
[SOURce<hw>]:AWGN:POWer:MODE.....	1022
[SOURce<hw>]:AWGN:POWer:NOISe.....	1023
[SOURce<hw>]:AWGN:POWer:NOISe:TOTal?.....	1024
[SOURce<hw>]:AWGN:POWer:RMODE.....	1022
[SOURce<hw>]:AWGN:POWer:SUM:PEP?.....	1024
[SOURce<hw>]:AWGN:POWer:SUM?.....	1024
[SOURce<hw>]:AWGN:STATe.....	1020
[SOURce<hw>]:BB:ARBITrary:CLOCK.....	1110
[SOURce<hw>]:BB:ARBITrary:CLOCK:MODE.....	1149
[SOURce<hw>]:BB:ARBITrary:CLOCK:SOURce.....	1148
[SOURce<hw>]:BB:ARBITrary:COUPled:STATe.....	1110
[SOURce<hw>]:BB:ARBITrary:COUPled:TRIGger:DELay:OFFSet.....	1110
[SOURce<hw>]:BB:ARBITrary:MCARrier:CARRier:COUNT.....	1122
[SOURce<hw>]:BB:ARBITrary:MCARrier:CARRier:MODE.....	1122
[SOURce<hw>]:BB:ARBITrary:MCARrier:CARRier:SPACing.....	1122
[SOURce<hw>]:BB:ARBITrary:MCARrier:CARRier<ch>:CONFLict?.....	1128
[SOURce<hw>]:BB:ARBITrary:MCARrier:CARRier<ch>:DELay.....	1128
[SOURce<hw>]:BB:ARBITrary:MCARrier:CARRier<ch>:FILE.....	1128
[SOURce<hw>]:BB:ARBITrary:MCARrier:CARRier<ch>:FREQuency.....	1127
[SOURce<hw>]:BB:ARBITrary:MCARrier:CARRier<ch>:PHASe.....	1127
[SOURce<hw>]:BB:ARBITrary:MCARrier:CARRier<ch>:POWer.....	1127
[SOURce<hw>]:BB:ARBITrary:MCARrier:CARRier<ch>:STATe.....	1126
[SOURce<hw>]:BB:ARBITrary:MCARrier:CFACTor:MODE.....	1123
[SOURce<hw>]:BB:ARBITrary:MCARrier:CLIPping:CFACTor.....	1124
[SOURce<hw>]:BB:ARBITrary:MCARrier:CLIPping:CUToff.....	1124
[SOURce<hw>]:BB:ARBITrary:MCARrier:CLIPping[:STATe].....	1124
[SOURce<hw>]:BB:ARBITrary:MCARrier:CLOad.....	1125
[SOURce<hw>]:BB:ARBITrary:MCARrier:CLOCK?.....	1126
[SOURce<hw>]:BB:ARBITrary:MCARrier:CREate.....	1126
[SOURce<hw>]:BB:ARBITrary:MCARrier:EDIT:CARRier:DELay:STEP.....	1130
[SOURce<hw>]:BB:ARBITrary:MCARrier:EDIT:CARRier:DELay[:START].....	1131
[SOURce<hw>]:BB:ARBITrary:MCARrier:EDIT:CARRier:EXECute.....	1131
[SOURce<hw>]:BB:ARBITrary:MCARrier:EDIT:CARRier:FILE.....	1131
[SOURce<hw>]:BB:ARBITrary:MCARrier:EDIT:CARRier:PHASe:STEP.....	1130
[SOURce<hw>]:BB:ARBITrary:MCARrier:EDIT:CARRier:PHASe[:START].....	1130
[SOURce<hw>]:BB:ARBITrary:MCARrier:EDIT:CARRier:POWer:STEP.....	1129
[SOURce<hw>]:BB:ARBITrary:MCARrier:EDIT:CARRier:POWer[:START].....	1129

[SOURce<hw>]:BB:ARBitrary:MCARrier:EDIT:CARRier:START	1129
[SOURce<hw>]:BB:ARBitrary:MCARrier:EDIT:CARRier:STATe	1128
[SOURce<hw>]:BB:ARBitrary:MCARrier:EDIT:CARRier:STOP	1129
[SOURce<hw>]:BB:ARBitrary:MCARrier:OFILe	1125
[SOURce<hw>]:BB:ARBitrary:MCARrier:POWer:REFerence	1125
[SOURce<hw>]:BB:ARBitrary:MCARrier:PRESet	1121
[SOURce<hw>]:BB:ARBitrary:MCARrier:SAMPles?	1123
[SOURce<hw>]:BB:ARBitrary:MCARrier:SETTing:CATalog?	1121
[SOURce<hw>]:BB:ARBitrary:MCARrier:SETTing:LOAD	1121
[SOURce<hw>]:BB:ARBitrary:MCARrier:SETTing:STORe	1122
[SOURce<hw>]:BB:ARBitrary:MCARrier:TIME	1123
[SOURce<hw>]:BB:ARBitrary:MCARrier:TIME:MODE	1125
[SOURce<hw>]:BB:ARBitrary:NOTCh	1133
[SOURce<hw>]:BB:ARBitrary:NOTCh:APPLy	1135
[SOURce<hw>]:BB:ARBitrary:NOTCh:CLOCK?	1133
[SOURce<hw>]:BB:ARBitrary:NOTCh:COUNT	1133
[SOURce<hw>]:BB:ARBitrary:NOTCh<ch>:BWIDth:RELative	1135
[SOURce<hw>]:BB:ARBitrary:NOTCh<ch>:BWIDth[:ABSolute]	1134
[SOURce<hw>]:BB:ARBitrary:NOTCh<ch>:FREQuency:OFFSet	1134
[SOURce<hw>]:BB:ARBitrary:NOTCh<ch>:STATe	1134
[SOURce<hw>]:BB:ARBitrary:PRAMP[:STATe]	1102
[SOURce<hw>]:BB:ARBitrary:PRESet	1101
[SOURce<hw>]:BB:ARBitrary:SIGNAL:TYPE	1103
[SOURce<hw>]:BB:ARBitrary:STATe	1102
[SOURce<hw>]:BB:ARBitrary:TRIGger:ARM:EXECute	1142
[SOURce<hw>]:BB:ARBitrary:TRIGger:DELay:UNIT	1144
[SOURce<hw>]:BB:ARBitrary:TRIGger:EXECute	1142
[SOURce<hw>]:BB:ARBitrary:TRIGger:OBASeband:DELay	1142
[SOURce<hw>]:BB:ARBitrary:TRIGger:OBASeband:INHibit	1143
[SOURce<hw>]:BB:ARBitrary:TRIGger:OBASeband:RDELay?	1143
[SOURce<hw>]:BB:ARBitrary:TRIGger:OBASeband:TDELay	1143
[SOURce<hw>]:BB:ARBitrary:TRIGger:OUTPut<ch>:DELay	1147
[SOURce<hw>]:BB:ARBitrary:TRIGger:OUTPut<ch>:DINSec?	1148
[SOURce<hw>]:BB:ARBitrary:TRIGger:OUTPut<ch>:MODE	1146
[SOURce<hw>]:BB:ARBitrary:TRIGger:OUTPut<ch>:OFFTime	1146
[SOURce<hw>]:BB:ARBitrary:TRIGger:OUTPut<ch>:ONTIME	1146
[SOURce<hw>]:BB:ARBitrary:TRIGger:OUTPut<ch>:PATTern	1146
[SOURce<hw>]:BB:ARBitrary:TRIGger:OUTPut<ch>:PULSe:DIVider	1147
[SOURce<hw>]:BB:ARBitrary:TRIGger:OUTPut<ch>:PULSe:FREQuency?	1147
[SOURce<hw>]:BB:ARBitrary:TRIGger:PTIME?	1142
[SOURce<hw>]:BB:ARBitrary:TRIGger:RMODE?	1139
[SOURce<hw>]:BB:ARBitrary:TRIGger:SLENgth	1141
[SOURce<hw>]:BB:ARBitrary:TRIGger:SLUNit	1141
[SOURce<hw>]:BB:ARBitrary:TRIGger:SMODE	1116
[SOURce<hw>]:BB:ARBitrary:TRIGger:SOURce	1138
[SOURce<hw>]:BB:ARBitrary:TRIGger:TIME:DATE	1140
[SOURce<hw>]:BB:ARBitrary:TRIGger:TIME:TIME	1140
[SOURce<hw>]:BB:ARBitrary:TRIGger:TIME[:STATe]	1141
[SOURce<hw>]:BB:ARBitrary:TRIGger[:EXTernal]:DELay	1144
[SOURce<hw>]:BB:ARBitrary:TRIGger[:EXTernal]:INHibit	1145

[ :SOURce<hw>]:BB:ARBitrary:TRIGger[:EXTErnal]:RDElay?	1145
[ :SOURce<hw>]:BB:ARBitrary:TRIGger[:EXTErnal]:SYNChronize:OUTPut	1142
[ :SOURce<hw>]:BB:ARBitrary:TRIGger[:EXTErnal]:TDElay	1144
[ :SOURce<hw>]:BB:ARBitrary:TSIGnal:AWGN:CREate	1106
[ :SOURce<hw>]:BB:ARBitrary:TSIGnal:AWGN:SAMPles	1106
[ :SOURce<hw>]:BB:ARBitrary:TSIGnal:CIQ:CREate	1106
[ :SOURce<hw>]:BB:ARBitrary:TSIGnal:CIQ:CREate:NAMed	1105
[ :SOURce<hw>]:BB:ARBitrary:TSIGnal:CIQ:I	1103
[ :SOURce<hw>]:BB:ARBitrary:TSIGnal:CIQ:Q	1103
[ :SOURce<hw>]:BB:ARBitrary:TSIGnal:RECTangle:AMPLitude	1103
[ :SOURce<hw>]:BB:ARBitrary:TSIGnal:RECTangle:CREate	1106
[ :SOURce<hw>]:BB:ARBitrary:TSIGnal:RECTangle:CREate:NAMed	1105
[ :SOURce<hw>]:BB:ARBitrary:TSIGnal:RECTangle:FREQuency	1103
[ :SOURce<hw>]:BB:ARBitrary:TSIGnal:RECTangle:OFFSet	1104
[ :SOURce<hw>]:BB:ARBitrary:TSIGnal:RECTangle:SAMPles	1104
[ :SOURce<hw>]:BB:ARBitrary:TSIGnal:SINE:CREate	1106
[ :SOURce<hw>]:BB:ARBitrary:TSIGnal:SINE:CREate:NAMed	1105
[ :SOURce<hw>]:BB:ARBitrary:TSIGnal:SINE:FREQuency	1104
[ :SOURce<hw>]:BB:ARBitrary:TSIGnal:SINE:PHASe	1105
[ :SOURce<hw>]:BB:ARBitrary:TSIGnal:SINE:SAMPles	1105
[ :SOURce<hw>]:BB:ARBitrary:WAVeform:CATalog:LENGTh?	1107
[ :SOURce<hw>]:BB:ARBitrary:WAVeform:CATalog?	1107
[ :SOURce<hw>]:BB:ARBitrary:WAVeform:CLOCK	1111
[ :SOURce<hw>]:BB:ARBitrary:WAVeform:DATA	1108
[ :SOURce<hw>]:BB:ARBitrary:WAVeform:DELeTe	1108
[ :SOURce<hw>]:BB:ARBitrary:WAVeform:FREE?	1108
[ :SOURce<hw>]:BB:ARBitrary:WAVeform:POINts?	1108
[ :SOURce<hw>]:BB:ARBitrary:WAVeform:SELEct	1107
[ :SOURce<hw>]:BB:ARBitrary:WAVeform:TAG?	1109
[ :SOURce<hw>]:BB:ARBitrary:WSEGment:CLOAd	1115
[ :SOURce<hw>]:BB:ARBitrary:WSEGment:CONFIgure:BLANK:APPend	1116
[ :SOURce<hw>]:BB:ARBitrary:WSEGment:CONFIgure:CATalog?	1117
[ :SOURce<hw>]:BB:ARBitrary:WSEGment:CONFIgure:CLOCK	1117
[ :SOURce<hw>]:BB:ARBitrary:WSEGment:CONFIgure:CLOCK:MODE	1117
[ :SOURce<hw>]:BB:ARBitrary:WSEGment:CONFIgure:COMMeNt	1118
[ :SOURce<hw>]:BB:ARBitrary:WSEGment:CONFIgure:DELeTe	1118
[ :SOURce<hw>]:BB:ARBitrary:WSEGment:CONFIgure:LEVel[:MODE]	1118
[ :SOURce<hw>]:BB:ARBitrary:WSEGment:CONFIgure:MARKer:ESEGment	1115
[ :SOURce<hw>]:BB:ARBitrary:WSEGment:CONFIgure:MARKer:FSEGment	1115
[ :SOURce<hw>]:BB:ARBitrary:WSEGment:CONFIgure:MARKer:MODE	1115
[ :SOURce<hw>]:BB:ARBitrary:WSEGment:CONFIgure:OFILe	1118
[ :SOURce<hw>]:BB:ARBitrary:WSEGment:CONFIgure:SEGMeNt:APPend	1119
[ :SOURce<hw>]:BB:ARBitrary:WSEGment:CONFIgure:SEGMeNt:CATalog?	1113
[ :SOURce<hw>]:BB:ARBitrary:WSEGment:CONFIgure:SEGMeNt:INDEx<ch0>:DELeTe	1119
[ :SOURce<hw>]:BB:ARBitrary:WSEGment:CONFIgure:SEGMeNt:INDEx<ch0>:DOWN	1119
[ :SOURce<hw>]:BB:ARBitrary:WSEGment:CONFIgure:SEGMeNt:INDEx<ch0>:UP	1119
[ :SOURce<hw>]:BB:ARBitrary:WSEGment:CONFIgure:SELEct	1120
[ :SOURce<hw>]:BB:ARBitrary:WSEGment:CREate	1114
[ :SOURce<hw>]:BB:ARBitrary:WSEGment:LMODE	1113
[ :SOURce<hw>]:BB:ARBitrary:WSEGment:NAME?	1112

[:SOURce<hw>]:BB:ARBitrary:WSEgment:NEXT.....	1112
[:SOURce<hw>]:BB:ARBitrary:WSEgment:NEXT:EXECute.....	1112
[:SOURce<hw>]:BB:ARBitrary:WSEgment:NEXT:SOURce.....	1113
[:SOURce<hw>]:BB:ARBitrary:WSEgment:SEquence:APPend.....	1114
[:SOURce<hw>]:BB:ARBitrary:WSEgment:SEquence:SElect.....	1113
[:SOURce<hw>]:BB:ARBitrary:WSEgment?.....	1112
[:SOURce<hw>]:BB:ARBitrary[:TRIGger]:SEquence.....	1138
[:SOURce<hw>]:BB:CFACtor?.....	1059
[:SOURce<hw>]:BB:CODer:MODE.....	1059
[:SOURce<hw>]:BB:DM:APSK16:GAMMa.....	1073
[:SOURce<hw>]:BB:DM:APSK32:GAMMa.....	1073
[:SOURce<hw>]:BB:DM:AQPSk:ANGLE.....	1071
[:SOURce<hw>]:BB:DM:ASK:DEPTTh.....	1072
[:SOURce<hw>]:BB:DM:CLISt:CATalog?.....	1086
[:SOURce<hw>]:BB:DM:CLISt:COPIY.....	1090
[:SOURce<hw>]:BB:DM:CLISt:DATA.....	1090
[:SOURce<hw>]:BB:DM:CLISt:DELeTe.....	1087
[:SOURce<hw>]:BB:DM:CLISt:FREE?.....	1088
[:SOURce<hw>]:BB:DM:CLISt:POINts?.....	1089
[:SOURce<hw>]:BB:DM:CLISt:SElect.....	1087
[:SOURce<hw>]:BB:DM:CLISt:TAG?.....	1092
[:SOURce<hw>]:BB:DM:CLOCK:MODE.....	1086
[:SOURce<hw>]:BB:DM:CLOCK:SOURce.....	1086
[:SOURce<hw>]:BB:DM:CODing.....	1071
[:SOURce<hw>]:BB:DM:DLISt:CATalog?.....	1086
[:SOURce<hw>]:BB:DM:DLISt:COPIY.....	1090
[:SOURce<hw>]:BB:DM:DLISt:DATA.....	1091
[:SOURce<hw>]:BB:DM:DLISt:DATA:APPend.....	1092
[:SOURce<hw>]:BB:DM:DLISt:DELeTe.....	1088
[:SOURce<hw>]:BB:DM:DLISt:FREE?.....	1088
[:SOURce<hw>]:BB:DM:DLISt:POINts.....	1089
[:SOURce<hw>]:BB:DM:DLISt:SElect.....	1087
[:SOURce<hw>]:BB:DM:DLISt:TAG?.....	1092
[:SOURce<hw>]:BB:DM:FILTer:PARAmeter:APCO25.....	1069
[:SOURce<hw>]:BB:DM:FILTer:PARAmeter:APCO25Lsm:GAUSS.....	1069
[:SOURce<hw>]:BB:DM:FILTer:PARAmeter:APCO25Lsm:LOWPass.....	1069
[:SOURce<hw>]:BB:DM:FILTer:PARAmeter:COSSine:BANDwidth.....	1069
[:SOURce<hw>]:BB:DM:FILTer:PARAmeter:COSSine[:ROLLoff].....	1069
[:SOURce<hw>]:BB:DM:FILTer:PARAmeter:GAUSS.....	1069
[:SOURce<hw>]:BB:DM:FILTer:PARAmeter:LPASS.....	1069
[:SOURce<hw>]:BB:DM:FILTer:PARAmeter:LPASSEVM.....	1069
[:SOURce<hw>]:BB:DM:FILTer:PARAmeter:PGAUSS.....	1069
[:SOURce<hw>]:BB:DM:FILTer:PARAmeter:RCOSSine.....	1069
[:SOURce<hw>]:BB:DM:FILTer:PARAmeter:SPHase.....	1069
[:SOURce<hw>]:BB:DM:FILTer:TYPE.....	1069
[:SOURce<hw>]:BB:DM:FLISt:CATalog?.....	1086
[:SOURce<hw>]:BB:DM:FLISt:DELeTe.....	1087
[:SOURce<hw>]:BB:DM:FLISt:FREE?.....	1088
[:SOURce<hw>]:BB:DM:FLISt:POINts?.....	1089
[:SOURce<hw>]:BB:DM:FLISt:SElect.....	1087

[[:SOURce<hw>]:BB:DM:FORMat.....	1071
[[:SOURce<hw>]:BB:DM:FSK:DEViation.....	1072
[[:SOURce<hw>]:BB:DM:FSK:VARiable:SYMBOL<ch0>:DEViation.....	1072
[[:SOURce<hw>]:BB:DM:FSK:VARiable:TYPE.....	1073
[[:SOURce<hw>]:BB:DM:MLISt:CATalog?.....	1086
[[:SOURce<hw>]:BB:DM:MLISt:DELete.....	1088
[[:SOURce<hw>]:BB:DM:MLISt:FREE?.....	1088
[[:SOURce<hw>]:BB:DM:MLISt:POINTs?.....	1089
[[:SOURce<hw>]:BB:DM:MLISt:SElect.....	1087
[[:SOURce<hw>]:BB:DM:PATtern.....	1065
[[:SOURce<hw>]:BB:DM:PRAMp:ATTenuation.....	1075
[[:SOURce<hw>]:BB:DM:PRAMp:BBONLY[:STATe].....	1076
[[:SOURce<hw>]:BB:DM:PRAMp:FDELay.....	1075
[[:SOURce<hw>]:BB:DM:PRAMp:RDELay.....	1075
[[:SOURce<hw>]:BB:DM:PRAMp:SHAPE.....	1074
[[:SOURce<hw>]:BB:DM:PRAMp:SOURce.....	1074
[[:SOURce<hw>]:BB:DM:PRAMp:TIME.....	1075
[[:SOURce<hw>]:BB:DM:PRAMp[:STATe].....	1076
[[:SOURce<hw>]:BB:DM:PRBS[:LENGth].....	1065
[[:SOURce<hw>]:BB:DM:PRESet.....	1064
[[:SOURce<hw>]:BB:DM:SETTing:CATalog?.....	1067
[[:SOURce<hw>]:BB:DM:SETTing:DELete.....	1068
[[:SOURce<hw>]:BB:DM:SETTing:LOAD.....	1068
[[:SOURce<hw>]:BB:DM:SETTing:STORe.....	1068
[[:SOURce<hw>]:BB:DM:SMODulation:BORDER.....	1066
[[:SOURce<hw>]:BB:DM:SMODulation:CDTDeviation.....	1066
[[:SOURce<hw>]:BB:DM:SMODulation:CLOCK:SLOPe:BIT.....	1066
[[:SOURce<hw>]:BB:DM:SMODulation:RCVState?.....	1067
[[:SOURce<hw>]:BB:DM:SMODulation:THRoughput:DELay?.....	1067
[[:SOURce<hw>]:BB:DM:SOURce.....	1065
[[:SOURce<hw>]:BB:DM:SRATE.....	1064
[[:SOURce<hw>]:BB:DM:STANdard.....	1064
[[:SOURce<hw>]:BB:DM:STANdard:ULISt:CATalog?.....	1067
[[:SOURce<hw>]:BB:DM:STANdard:ULISt:DELete.....	1068
[[:SOURce<hw>]:BB:DM:STANdard:ULISt:LOAD.....	1068
[[:SOURce<hw>]:BB:DM:STANdard:ULISt:STORe.....	1068
[[:SOURce<hw>]:BB:DM:STATe.....	1063
[[:SOURce<hw>]:BB:DM:SWITching:STATe.....	1074
[[:SOURce<hw>]:BB:DM:TRIGger:ARM:EXECute.....	1080
[[:SOURce<hw>]:BB:DM:TRIGger:DELay:UNIT.....	1081
[[:SOURce<hw>]:BB:DM:TRIGger:EXECute.....	1080
[[:SOURce<hw>]:BB:DM:TRIGger:EXTernal:SYNChronize:OUTPut.....	1080
[[:SOURce<hw>]:BB:DM:TRIGger:OBASeband:DELay.....	1080
[[:SOURce<hw>]:BB:DM:TRIGger:OBASeband:INHibit.....	1081
[[:SOURce<hw>]:BB:DM:TRIGger:OBASeband:RDELay?.....	1081
[[:SOURce<hw>]:BB:DM:TRIGger:OBASeband:TDELay.....	1081
[[:SOURce<hw>]:BB:DM:TRIGger:OUTPut<ch>:DELay.....	1085
[[:SOURce<hw>]:BB:DM:TRIGger:OUTPut<ch>:MODE.....	1083
[[:SOURce<hw>]:BB:DM:TRIGger:OUTPut<ch>:OFFTime.....	1084
[[:SOURce<hw>]:BB:DM:TRIGger:OUTPut<ch>:ONTime.....	1084



[:SOURce<hw>]:BB:DM:TRIGger:OUTPut<ch>:PATTern.....	1084
[:SOURce<hw>]:BB:DM:TRIGger:OUTPut<ch>:PULSe:DIVider.....	1085
[:SOURce<hw>]:BB:DM:TRIGger:OUTPut<ch>:PULSe:FREQUency?.....	1085
[:SOURce<hw>]:BB:DM:TRIGger:RMODE?.....	1078
[:SOURce<hw>]:BB:DM:TRIGger:SLENgth.....	1078
[:SOURce<hw>]:BB:DM:TRIGger:SOURce.....	1077
[:SOURce<hw>]:BB:DM:TRIGger:TIME:DATE.....	1078
[:SOURce<hw>]:BB:DM:TRIGger:TIME:TIME.....	1079
[:SOURce<hw>]:BB:DM:TRIGger:TIME[:STATe].....	1079
[:SOURce<hw>]:BB:DM:TRIGger[:EXTErnal]:DELay.....	1082
[:SOURce<hw>]:BB:DM:TRIGger[:EXTErnal]:INHibit.....	1083
[:SOURce<hw>]:BB:DM:TRIGger[:EXTErnal]:RDELay?.....	1083
[:SOURce<hw>]:BB:DM:TRIGger[:EXTErnal]:TDELay.....	1082
[:SOURce<hw>]:BB:DM[:TRIGger]:SEQUence.....	1077
[:SOURce<hw>]:BB:DVB:NOTCh.....	1132
[:SOURce<hw>]:BB:DVB:NOTCh:APPLY.....	1135
[:SOURce<hw>]:BB:DVB:NOTCh:CLOCK?.....	1133
[:SOURce<hw>]:BB:DVB:NOTCh:COUNT.....	1133
[:SOURce<hw>]:BB:DVB:NOTCh<ch>:BWIDth:RELative.....	1135
[:SOURce<hw>]:BB:DVB:NOTCh<ch>:BWIDth[:ABSolute].....	1134
[:SOURce<hw>]:BB:DVB:NOTCh<ch>:FREQUency:OFFSet.....	1134
[:SOURce<hw>]:BB:DVB:NOTCh<ch>:STATe.....	1133
[:SOURce<hw>]:BB:EUTRa:NOTCh.....	1132
[:SOURce<hw>]:BB:EUTRa:NOTCh:APPLY.....	1135
[:SOURce<hw>]:BB:EUTRa:NOTCh:CLOCK?.....	1133
[:SOURce<hw>]:BB:EUTRa:NOTCh:COUNT.....	1133
[:SOURce<hw>]:BB:EUTRa:NOTCh<ch>:BWIDth:RELative.....	1135
[:SOURce<hw>]:BB:EUTRa:NOTCh<ch>:BWIDth[:ABSolute].....	1134
[:SOURce<hw>]:BB:EUTRa:NOTCh<ch>:FREQUency:OFFSet.....	1134
[:SOURce<hw>]:BB:EUTRa:NOTCh<ch>:STATe.....	1133
[:SOURce<hw>]:BB:FOFFset.....	1057
[:SOURce<hw>]:BB:GRAPhics:MODE.....	1174
[:SOURce<hw>]:BB:GRAPhics:SRATE:MODE.....	1175
[:SOURce<hw>]:BB:GRAPhics:SRATE:USER.....	1175
[:SOURce<hw>]:BB:GRAPhics:TRIGger:SOURce.....	1177
[:SOURce<hw>]:BB:IMPairment:OPTimization:MODE.....	1173
[:SOURce<hw>]:BB:IQGain.....	1210
[:SOURce<hw>]:BB:MCCW:CARRier:COUNT.....	1155
[:SOURce<hw>]:BB:MCCW:CARRier:LIST:PHASe.....	1158
[:SOURce<hw>]:BB:MCCW:CARRier:LIST:POWer.....	1159
[:SOURce<hw>]:BB:MCCW:CARRier:LIST:STATe.....	1157
[:SOURce<hw>]:BB:MCCW:CARRier:PHASe.....	1158
[:SOURce<hw>]:BB:MCCW:CARRier:POWer.....	1159
[:SOURce<hw>]:BB:MCCW:CARRier:SPACing.....	1155
[:SOURce<hw>]:BB:MCCW:CARRier:STATe.....	1157
[:SOURce<hw>]:BB:MCCW:CFACtor.....	1156
[:SOURce<hw>]:BB:MCCW:CFACtor:ACTual?.....	1156
[:SOURce<hw>]:BB:MCCW:CFACtor:MODE.....	1156
[:SOURce<hw>]:BB:MCCW:CLOCK:MODE.....	1169
[:SOURce<hw>]:BB:MCCW:CLOCK:SOURce.....	1168

[:SOURce<hw>]:BB:MCCW:CLOCK?	1156
[:SOURce<hw>]:BB:MCCW:EDIT:CARRIER:EXECute	1161
[:SOURce<hw>]:BB:MCCW:EDIT:CARRIER:PHASe:STEP	1160
[:SOURce<hw>]:BB:MCCW:EDIT:CARRIER:PHASe[:START]	1159
[:SOURce<hw>]:BB:MCCW:EDIT:CARRIER:POWer:STEP	1160
[:SOURce<hw>]:BB:MCCW:EDIT:CARRIER:POWer[:START]	1159
[:SOURce<hw>]:BB:MCCW:EDIT:CARRIER:START	1160
[:SOURce<hw>]:BB:MCCW:EDIT:CARRIER:STATe	1161
[:SOURce<hw>]:BB:MCCW:EDIT:CARRIER:STOP	1160
[:SOURce<hw>]:BB:MCCW:PRESet	1154
[:SOURce<hw>]:BB:MCCW:STATe	1155
[:SOURce<hw>]:BB:MCCW:TRIGger:ARM:EXECute	1164
[:SOURce<hw>]:BB:MCCW:TRIGger:EXECute	1164
[:SOURce<hw>]:BB:MCCW:TRIGger:EXTerNal:SYNChronize:OUTPut	1165
[:SOURce<hw>]:BB:MCCW:TRIGger:OBASeband:DELAy	1165
[:SOURce<hw>]:BB:MCCW:TRIGger:OBASeband:INHibit	1165
[:SOURce<hw>]:BB:MCCW:TRIGger:OUTPut<ch>:DELAy	1168
[:SOURce<hw>]:BB:MCCW:TRIGger:OUTPut<ch>:MODE	1166
[:SOURce<hw>]:BB:MCCW:TRIGger:OUTPut<ch>:OFFTime	1167
[:SOURce<hw>]:BB:MCCW:TRIGger:OUTPut<ch>:ONTime	1167
[:SOURce<hw>]:BB:MCCW:TRIGger:OUTPut<ch>:PATTerN	1167
[:SOURce<hw>]:BB:MCCW:TRIGger:OUTPut<ch>:PULSe:DIVider	1167
[:SOURce<hw>]:BB:MCCW:TRIGger:OUTPut<ch>:PULSe:FREQUency?	1168
[:SOURce<hw>]:BB:MCCW:TRIGger:RMODE?	1162
[:SOURce<hw>]:BB:MCCW:TRIGger:SLENgth	1164
[:SOURce<hw>]:BB:MCCW:TRIGger:SOURce	1162
[:SOURce<hw>]:BB:MCCW:TRIGger:TIME:DATE	1163
[:SOURce<hw>]:BB:MCCW:TRIGger:TIME:TIME	1163
[:SOURce<hw>]:BB:MCCW:TRIGger:TIME[:STATe]	1164
[:SOURce<hw>]:BB:MCCW:TRIGger[:EXTerNal<ch>]:DELAy	1165
[:SOURce<hw>]:BB:MCCW:TRIGger[:EXTerNal<ch>]:INHibit	1166
[:SOURce<hw>]:BB:MCCW[:TRIGger]:SEQUence	1161
[:SOURce<hw>]:BB:OFDM:NOTCh	1132
[:SOURce<hw>]:BB:OFDM:NOTCh:APPLy	1135
[:SOURce<hw>]:BB:OFDM:NOTCh:CLOCK?	1133
[:SOURce<hw>]:BB:OFDM:NOTCh:COUNT	1133
[:SOURce<hw>]:BB:OFDM:NOTCh<ch>:BWIth:RELAtive	1135
[:SOURce<hw>]:BB:OFDM:NOTCh<ch>:BWIth[:ABSolute]	1134
[:SOURce<hw>]:BB:OFDM:NOTCh<ch>:FREQUency:OFFSet	1134
[:SOURce<hw>]:BB:OFDM:NOTCh<ch>:STATe	1133
[:SOURce<hw>]:BB:ONEWeb:NOTCh	1133
[:SOURce<hw>]:BB:ONEWeb:NOTCh:APPLy	1135
[:SOURce<hw>]:BB:ONEWeb:NOTCh:CLOCK?	1133
[:SOURce<hw>]:BB:ONEWeb:NOTCh:COUNT	1133
[:SOURce<hw>]:BB:ONEWeb:NOTCh<ch>:BWIth:RELAtive	1135
[:SOURce<hw>]:BB:ONEWeb:NOTCh<ch>:BWIth[:ABSolute]	1134
[:SOURce<hw>]:BB:ONEWeb:NOTCh<ch>:FREQUency:OFFSet	1134
[:SOURce<hw>]:BB:ONEWeb:NOTCh<ch>:STATe	1134
[:SOURce<hw>]:BB:PGAin	1058
[:SOURce<hw>]:BB:POFFset	1058

[[:SOURce<hw>]:BB:POWer:PEAK?.....	1059
[[:SOURce<hw>]:BB:POWer:RMS?.....	1060
[[:SOURce<hw>]:BB:PROGress:MCODer:ARBitrary:MCARrier?.....	1184
[[:SOURce<hw>]:BB:PROGress:MCODer:ARBitrary:WSEgment?.....	1184
[[:SOURce<hw>]:BB:PROGress:MCODer:DM:FiLTeR?.....	1184
[[:SOURce<hw>]:BB:PROGress:MCODer?.....	1184
[[:SOURce<hw>]:BB:ROUte.....	1059
[[:SOURce<hw>]:BBIN:ALEVel:EXECute.....	1034
[[:SOURce<hw>]:BBIN:CDEvice?.....	1029
[[:SOURce<hw>]:BBIN:CHANnel<ch0>:BB:STATe.....	1029
[[:SOURce<hw>]:BBIN:CHANnel<ch0>:NAME.....	1029
[[:SOURce<hw>]:BBIN:CHANnel<ch0>:POWer:CFACtor.....	1030
[[:SOURce<hw>]:BBIN:CHANnel<ch0>:POWer:PEAK.....	1030
[[:SOURce<hw>]:BBIN:CHANnel<ch0>:POWer:RMS.....	1030
[[:SOURce<hw>]:BBIN:CHANnel<ch0>:SRATe.....	1031
[[:SOURce<hw>]:BBIN:DiGital:ASETting:STATe.....	1033
[[:SOURce<hw>]:BBIN:DiGital:INTeRface.....	1029
[[:SOURce<hw>]:BBIN:DiGital:SOURce.....	1028
[[:SOURce<hw>]:BBIN:FOFFset.....	1057
[[:SOURce<hw>]:BBIN:IQSWap[:STATe].....	1031
[[:SOURce<hw>]:BBIN:MODE.....	1031
[[:SOURce<hw>]:BBIN:MPERiod.....	1033
[[:SOURce<hw>]:BBIN:OLOad:HOLD:RESet.....	1036
[[:SOURce<hw>]:BBIN:OLOad:HOLD:STATe?.....	1035
[[:SOURce<hw>]:BBIN:OLOad:STATe?.....	1035
[[:SOURce<hw>]:BBIN:PGAin.....	1058
[[:SOURce<hw>]:BBIN:POFFset.....	1058
[[:SOURce<hw>]:BBIN:POWer:CFACtor.....	1034
[[:SOURce<hw>]:BBIN:POWer:PEAK.....	1034
[[:SOURce<hw>]:BBIN:POWer:RMS?.....	1035
[[:SOURce<hw>]:BBIN:ROUte.....	1059
[[:SOURce<hw>]:BBIN:SRATe:MAX?.....	1032
[[:SOURce<hw>]:BBIN:SRATe:SOURce.....	1032
[[:SOURce<hw>]:BBIN:SRATe:SUM?.....	1032
[[:SOURce<hw>]:BBIN:SRATe[:ACTual].....	1033
[[:SOURce<hw>]:BBIN:STATe.....	1028
[[:SOURce<hw>]:CORRection:CSET:DATA:FREQUency.....	1188
[[:SOURce<hw>]:CORRection:CSET:DATA:FREQUency:POINts?.....	1188
[[:SOURce<hw>]:CORRection:CSET:DATA:POWer.....	1188
[[:SOURce<hw>]:CORRection:CSET:DATA:POWer:POINts?.....	1188
[[:SOURce<hw>]:CORRection:CSET:DATA[:SENSor<ch>][:POWer]:SONCe.....	1188
[[:SOURce<hw>]:CORRection:CSET:DATA[:SENSor<ch>][:POWer]:SONCe.....	1190
[[:SOURce<hw>]:CORRection:CSET[:SELeCt].....	1189
[[:SOURce<hw>]:CORRection:DEXChange:AFILe:CATalog?.....	1191
[[:SOURce<hw>]:CORRection:DEXChange:AFILe:EXTeNtion.....	1191
[[:SOURce<hw>]:CORRection:DEXChange:AFILe:SELeCt.....	1191
[[:SOURce<hw>]:CORRection:DEXChange:AFILe:SEParator:COLumn.....	1192
[[:SOURce<hw>]:CORRection:DEXChange:AFILe:SEParator:DECimal.....	1192
[[:SOURce<hw>]:CORRection:DEXChange:EXECute.....	1192
[[:SOURce<hw>]:CORRection:DEXChange:MODE.....	1192

[:SOURce<hw>]:CORRection:DEXChange:SElect.....	1193
[:SOURce<hw>]:CORRection:OPTimize:RF:CHARacteristics.....	1195
[:SOURce<hw>]:CORRection:OPTimize:RF:HEADroom.....	1195
[:SOURce<hw>]:CORRection:OPTimize:RF:IQModulator.....	1195
[:SOURce<hw>]:CORRection:OPTimize:RF:IQModulator:ADJust?.....	1196
[:SOURce<hw>]:CORRection:OPTimize:RF:LINEarize.....	1196
[:SOURce<hw>]:CORRection:OPTimize:RF:LINEarize:ADJust?.....	1197
[:SOURce<hw>]:CORRection:VALue?.....	1189
[:SOURce<hw>]:CORRection:ZERoing:STATe.....	1189
[:SOURce<hw>]:CORRection[:STATe].....	1190
[:SOURce<hw>]:DM:FILTer:PARAmeter.....	1070
[:SOURce<hw>]:FM:DEViation:MODE.....	1045
[:SOURce<hw>]:FM:DEViation:SUM.....	1045
[:SOURce<hw>]:FM:MODE.....	1046
[:SOURce<hw>]:FM:RATio.....	1045
[:SOURce<hw>]:FM:SENSitivity?.....	1046
[:SOURce<hw>]:FM<ch>:SOURce.....	1044
[:SOURce<hw>]:FM<ch>:STATe.....	1043
[:SOURce<hw>]:FM<ch>[:DEViation].....	1044
[:SOURce<hw>]:FREQuency:CENTer.....	1204
[:SOURce<hw>]:FREQuency:CONVerter:EXTernal:OVERrange:ALLowed[:STATe]?.....	1207
[:SOURce<hw>]:FREQuency:CONVerter:EXTernal:OVERrange:FREQuency:MAX?.....	1207
[:SOURce<hw>]:FREQuency:CONVerter:EXTernal:OVERrange:FREQuency:MIN?.....	1208
[:SOURce<hw>]:FREQuency:CONVerter:EXTernal:OVERrange[:STATe].....	1208
[:SOURce<hw>]:FREQuency:LOSCillator:INPut:FREQuency?.....	1199
[:SOURce<hw>]:FREQuency:LOSCillator:MODE.....	1200
[:SOURce<hw>]:FREQuency:LOSCillator:OUTPut:FREQuency?.....	1201
[:SOURce<hw>]:FREQuency:LOSCillator:OUTPut:STATe.....	1201
[:SOURce<hw>]:FREQuency:MANual.....	1203
[:SOURce<hw>]:FREQuency:MODE.....	1201
[:SOURce<hw>]:FREQuency:MULTIplier.....	1203
[:SOURce<hw>]:FREQuency:OFFSet.....	1204
[:SOURce<hw>]:FREQuency:SPAN.....	1205
[:SOURce<hw>]:FREQuency:STARt.....	1205
[:SOURce<hw>]:FREQuency:STEP:MODE.....	1206
[:SOURce<hw>]:FREQuency:STEP[:INCRement].....	1206
[:SOURce<hw>]:FREQuency:STOP.....	1205
[:SOURce<hw>]:FREQuency[:CW FIXed].....	1202
[:SOURce<hw>]:FREQuency[:CW FIXed]:RCL.....	1203
[:SOURce<hw>]:INPut:MODext:COUPling<ch>.....	1208
[:SOURce<hw>]:INPut:MODext:IMPedance<ch>.....	1209
[:SOURce<hw>]:INPut:TM:CLOCK:IMPedance.....	1015
[:SOURce<hw>]:INPut:TM:CLOCK:LEVel.....	1015
[:SOURce<hw>]:INPut:TM:CLOCK:SLOPe.....	1015
[:SOURce<hw>]:INPut:TM:TRIGger:IMPedance.....	1015
[:SOURce<hw>]:INPut:TM:TRIGger:LEVel.....	1015
[:SOURce<hw>]:INPut:TM:TRIGger:SLOPe.....	1016
[:SOURce<hw>]:INPut:TM<ch>:DIRrection.....	1008
[:SOURce<hw>]:INPut:TM<ch>:SIGNal.....	1009
[:SOURce<hw>]:INPut:TRIGger:SLOPe.....	1209

[[:SOURce<hw>]:IQ:CREStfactor.....	1211
[[:SOURce<hw>]:IQ:GAIN.....	1210
[[:SOURce<hw>]:IQ:IMPAirment:IQRatio[:MAGNitude].....	1171
[[:SOURce<hw>]:IQ:IMPAirment:LEAKage:I.....	1171
[[:SOURce<hw>]:IQ:IMPAirment:LEAKage:Q.....	1171
[[:SOURce<hw>]:IQ:IMPAirment:QUADrature[:ANGLE].....	1172
[[:SOURce<hw>]:IQ:IMPAirment[:STATE].....	1172
[[:SOURce<hw>]:IQ:OUTPut:ANALog:STATe.....	1213
[[:SOURce<hw>]:IQ:OUTPut:LEVel.....	1215
[[:SOURce<hw>]:IQ:OUTPut[:ANALog]:BIAS:COUPling[:STATE].....	1216
[[:SOURce<hw>]:IQ:OUTPut[:ANALog]:BIAS:I.....	1216
[[:SOURce<hw>]:IQ:OUTPut[:ANALog]:BIAS:Q.....	1216
[[:SOURce<hw>]:IQ:OUTPut[:ANALog]:MODE.....	1215
[[:SOURce<hw>]:IQ:OUTPut[:ANALog]:OFFSet:I.....	1217
[[:SOURce<hw>]:IQ:OUTPut[:ANALog]:OFFSet:Q.....	1217
[[:SOURce<hw>]:IQ:OUTPut[:ANALog]:PRESet.....	1214
[[:SOURce<hw>]:IQ:OUTPut[:ANALog]:SETTing:CATalog?.....	1214
[[:SOURce<hw>]:IQ:OUTPut[:ANALog]:SETTing:DELeTe.....	1215
[[:SOURce<hw>]:IQ:OUTPut[:ANALog]:SETTing:LOAD.....	1214
[[:SOURce<hw>]:IQ:OUTPut[:ANALog]:SETTing:STORe.....	1214
[[:SOURce<hw>]:IQ:OUTPut[:ANALog]:TYPE.....	1215
[[:SOURce<hw>]:IQ:SOURce.....	1210
[[:SOURce<hw>]:IQ:STATe.....	1210
[[:SOURce<hw>]:IQ:SWAP[:STATE].....	1212
[[:SOURce<hw>]:IQ:WBState.....	1212
[[:SOURce<hw>]:LFOutput:FREQuency:MANual.....	1231
[[:SOURce<hw>]:LFOutput:FREQuency:MODE.....	1231
[[:SOURce<hw>]:LFOutput:FREQuency:STARt.....	1232
[[:SOURce<hw>]:LFOutput:FREQuency:STOP.....	1232
[[:SOURce<hw>]:LFOutput:SWEep[:FREQuency]:DWELL.....	1237
[[:SOURce<hw>]:LFOutput:SWEep[:FREQuency]:EXECute.....	1237
[[:SOURce<hw>]:LFOutput:SWEep[:FREQuency]:MODE.....	1237
[[:SOURce<hw>]:LFOutput:SWEep[:FREQuency]:POINts.....	1238
[[:SOURce<hw>]:LFOutput:SWEep[:FREQuency]:RETRace.....	1238
[[:SOURce<hw>]:LFOutput:SWEep[:FREQuency]:RUNNing?.....	1238
[[:SOURce<hw>]:LFOutput:SWEep[:FREQuency]:SHApe.....	1239
[[:SOURce<hw>]:LFOutput:SWEep[:FREQuency]:SPACing.....	1239
[[:SOURce<hw>]:LFOutput:SWEep[:FREQuency]:STEP:LOGarithmic.....	1239
[[:SOURce<hw>]:LFOutput:SWEep[:FREQuency]:STEP:LINear].....	1239
[[:SOURce<hw>]:LFOutput<ch>:FREQuency.....	1230
[[:SOURce<hw>]:LFOutput<ch>:PERiod?.....	1230
[[:SOURce<hw>]:LFOutput<ch>:SHApe.....	1234
[[:SOURce<hw>]:LFOutput<ch>:SHApe:PULSe:DCYClE.....	1234
[[:SOURce<hw>]:LFOutput<ch>:SHApe:PULSe:PERiod.....	1234
[[:SOURce<hw>]:LFOutput<ch>:SHApe:PULSe:WIDTh.....	1234
[[:SOURce<hw>]:LFOutput<ch>:SHApe:TRAPeZe:FALL.....	1235
[[:SOURce<hw>]:LFOutput<ch>:SHApe:TRAPeZe:HIGH.....	1235
[[:SOURce<hw>]:LFOutput<ch>:SHApe:TRAPeZe:PERiod.....	1235
[[:SOURce<hw>]:LFOutput<ch>:SHApe:TRAPeZe:RISE.....	1235
[[:SOURce<hw>]:LFOutput<ch>:SHApe:TRIangle:PERiod.....	1236

[SOURce<hw>]:LFOutput<ch>:SHAPE:TRlangle:RISE.....	1236
[SOURce<hw>]:LIST:CATalog?.....	1250
[SOURce<hw>]:LIST:DELeTe.....	1250
[SOURce<hw>]:LIST:DELeTe:ALL.....	1251
[SOURce<hw>]:LIST:DEXChange:AFILe:CATalog?.....	1252
[SOURce<hw>]:LIST:DEXChange:AFILe:EXTension.....	1252
[SOURce<hw>]:LIST:DEXChange:AFILe:SELeCt.....	1253
[SOURce<hw>]:LIST:DEXChange:AFILe:SEParator:COLumn.....	1253
[SOURce<hw>]:LIST:DEXChange:AFILe:SEParator:DECimal.....	1253
[SOURce<hw>]:LIST:DEXChange:EXECute.....	1253
[SOURce<hw>]:LIST:DEXChange:MODE.....	1254
[SOURce<hw>]:LIST:DEXChange:SELeCt.....	1254
[SOURce<hw>]:LIST:DWELI.....	1244
[SOURce<hw>]:LIST:DWELI:LIST.....	1245
[SOURce<hw>]:LIST:DWELI:LIST:POINts?.....	1245
[SOURce<hw>]:LIST:DWELI:MODE.....	1244
[SOURce<hw>]:LIST:FREE?.....	1251
[SOURce<hw>]:LIST:FREQUency.....	1245
[SOURce<hw>]:LIST:FREQUency:POINts?.....	1246
[SOURce<hw>]:LIST:INDEx.....	1246
[SOURce<hw>]:LIST:INDEx:STARt.....	1246
[SOURce<hw>]:LIST:INDEx:STOP.....	1246
[SOURce<hw>]:LIST:LEARn.....	1247
[SOURce<hw>]:LIST:MODE.....	1247
[SOURce<hw>]:LIST:POWer.....	1248
[SOURce<hw>]:LIST:POWer:POINts?.....	1248
[SOURce<hw>]:LIST:RESEt.....	1251
[SOURce<hw>]:LIST:RMODE.....	1247
[SOURce<hw>]:LIST:RUNNing?.....	1250
[SOURce<hw>]:LIST:SELeCt.....	1252
[SOURce<hw>]:LIST:TRIGger:EXECute.....	1249
[SOURce<hw>]:LIST:TRIGger:SOURce.....	1249
[SOURce<hw>]:MODulation[:ALL][:STATe].....	1036
[SOURce<hw>]:NOISe:BANDwidth BWIDth.....	1255
[SOURce<hw>]:NOISe:DISTRibution.....	1256
[SOURce<hw>]:NOISe:IMPulsive:CL.....	1257
[SOURce<hw>]:NOISe:IMPulsive:FRAMe.....	1257
[SOURce<hw>]:NOISe:IMPulsive:MAXSpace.....	1258
[SOURce<hw>]:NOISe:IMPulsive:MINSpace.....	1258
[SOURce<hw>]:NOISe:IMPulsive:PULSe.....	1257
[SOURce<hw>]:NOISe:IMPulsive[:BURSt]:DURation?.....	1258
[SOURce<hw>]:NOISe:IMPulsive[:STATe].....	1257
[SOURce<hw>]:NOISe:LEVel<ch>:RELative?.....	1256
[SOURce<hw>]:NOISe:LEVel<ch>[:ABSolute]?.....	1256
[SOURce<hw>]:NOISe:PHASenoiSe:FREQUency<ch>.....	1260
[SOURce<hw>]:NOISe:PHASenoiSe:LEVel<ch>.....	1259
[SOURce<hw>]:NOISe:PHASenoiSe:SHAPE:PREDeFined:CATalog?.....	1259
[SOURce<hw>]:NOISe:PHASenoiSe:SHAPE:SELeCt.....	1259
[SOURce<hw>]:NOISe:PHASenoiSe:SHAPE:STORE.....	1259
[SOURce<hw>]:NOISe:PHASenoiSe[:STATe].....	1258

[[:SOURce<hw>]:PGENerator:OUTPut:POLarity.....	1263
[[:SOURce<hw>]:PGENerator:OUTPut[:STATe].....	1263
[[:SOURce<hw>]:PGENerator:STATe.....	1263
[[:SOURce<hw>]:PHASe.....	1264
[[:SOURce<hw>]:PHASe:REFerence.....	1264
[[:SOURce<hw>]:PM:DEViation:MODE.....	1049
[[:SOURce<hw>]:PM:DEViation:SUM.....	1050
[[:SOURce<hw>]:PM:MODE.....	1049
[[:SOURce<hw>]:PM:RATio.....	1050
[[:SOURce<hw>]:PM:SENSitivity?.....	1050
[[:SOURce<hw>]:PM<ch>:SOURce.....	1048
[[:SOURce<hw>]:PM<ch>:STATe.....	1048
[[:SOURce<hw>]:POWer:AATTenuation?.....	1269
[[:SOURce<hw>]:POWer:ALC:DAMPLifier.....	1268
[[:SOURce<hw>]:POWer:ALC:DSENSitivity.....	1268
[[:SOURce<hw>]:POWer:ALC:MODE?.....	1267
[[:SOURce<hw>]:POWer:ALC:SLEVel.....	1269
[[:SOURce<hw>]:POWer:ALC:SONCe.....	1268
[[:SOURce<hw>]:POWer:ALC[:STATe].....	1267
[[:SOURce<hw>]:POWer:ATTenuation.....	1269
[[:SOURce<hw>]:POWer:ATTenuation:DIGital.....	1270
[[:SOURce<hw>]:POWer:ATTenuation:INACTive:INDices.....	1269
[[:SOURce<hw>]:POWer:ATTenuation:RFOff:MODE.....	1270
[[:SOURce<hw>]:POWer:EMF:STATe.....	1270
[[:SOURce<hw>]:POWer:LBEHaviour.....	1271
[[:SOURce<hw>]:POWer:LIMit[:AMPLitude].....	1271
[[:SOURce<hw>]:POWer:LMODE.....	1271
[[:SOURce<hw>]:POWer:MANual.....	1272
[[:SOURce<hw>]:POWer:MODE.....	1272
[[:SOURce<hw>]:POWer:PEP?.....	1273
[[:SOURce<hw>]:POWer:POWer.....	1273
[[:SOURce<hw>]:POWer:RANGe:LOWer?.....	1280
[[:SOURce<hw>]:POWer:RANGe:UPPer?.....	1280
[[:SOURce<hw>]:POWer:SPC:CRANGe.....	1274
[[:SOURce<hw>]:POWer:SPC:DELay.....	1274
[[:SOURce<hw>]:POWer:SPC:MEASure.....	1275
[[:SOURce<hw>]:POWer:SPC:MODE.....	1275
[[:SOURce<hw>]:POWer:SPC:PEAK.....	1275
[[:SOURce<hw>]:POWer:SPC:SElect.....	1275
[[:SOURce<hw>]:POWer:SPC:SINGLE.....	1276
[[:SOURce<hw>]:POWer:SPC:STATe.....	1276
[[:SOURce<hw>]:POWer:SPC:TARGet.....	1276
[[:SOURce<hw>]:POWer:SPC:WARNIing?.....	1276
[[:SOURce<hw>]:POWer:STARt.....	1274
[[:SOURce<hw>]:POWer:STEP:MODE.....	1277
[[:SOURce<hw>]:POWer:STEP[:INCRement].....	1277
[[:SOURce<hw>]:POWer:STOP.....	1274
[[:SOURce<hw>]:POWer[:LEVel][:IMMediate]:OFFSet.....	1278
[[:SOURce<hw>]:POWer[:LEVel][:IMMediate]:RCL.....	1278
[[:SOURce<hw>]:POWer[:LEVel][:IMMediate]:REFLevel.....	1279

[[:SOURce<hw>]:POWER[:LEVel][:IMMediate][:AMPLitude].....	1279
[[:SOURce<hw>]:PULM:DELAy.....	1053
[[:SOURce<hw>]:PULM:DOUBle:DELAy.....	1054
[[:SOURce<hw>]:PULM:DOUBle:STATe.....	1054
[[:SOURce<hw>]:PULM:DOUBle:WIDTh.....	1054
[[:SOURce<hw>]:PULM:IMPedance.....	1056
[[:SOURce<hw>]:PULM:MODE.....	1052
[[:SOURce<hw>]:PULM:OUTPut:VIDeo:POLarity.....	1055
[[:SOURce<hw>]:PULM:PERiod.....	1053
[[:SOURce<hw>]:PULM:POLarity.....	1056
[[:SOURce<hw>]:PULM:SOURce.....	1055
[[:SOURce<hw>]:PULM:STATe.....	1054
[[:SOURce<hw>]:PULM:TRIGger:EXTernal:IMPedance.....	1056
[[:SOURce<hw>]:PULM:TRIGger:MODE.....	1053
[[:SOURce<hw>]:PULM:TTYPe.....	1055
[[:SOURce<hw>]:PULM:WIDTh.....	1053
[[:SOURce<hw>]:SWEep:POWER:AMODE.....	1289
[[:SOURce<hw>]:SWEep:POWER:DWELI.....	1290
[[:SOURce<hw>]:SWEep:POWER:EXECute.....	1293
[[:SOURce<hw>]:SWEep:POWER:MODE.....	1290
[[:SOURce<hw>]:SWEep:POWER:POINts.....	1290
[[:SOURce<hw>]:SWEep:POWER:RETRace.....	1294
[[:SOURce<hw>]:SWEep:POWER:RUNNing?.....	1294
[[:SOURce<hw>]:SWEep:POWER:SHAPE.....	1293
[[:SOURce<hw>]:SWEep:POWER:SPACing:MODE?.....	1291
[[:SOURce<hw>]:SWEep:POWER:STEP[:LOGarithmic].....	1291
[[:SOURce<hw>]:SWEep:RESEt[:ALL].....	1295
[[:SOURce<hw>]:SWEep[:FREQUency]:DWELI.....	1291
[[:SOURce<hw>]:SWEep[:FREQUency]:EXECute.....	1293
[[:SOURce<hw>]:SWEep[:FREQUency]:MODE.....	1292
[[:SOURce<hw>]:SWEep[:FREQUency]:POINts.....	1292
[[:SOURce<hw>]:SWEep[:FREQUency]:RETRace.....	1294
[[:SOURce<hw>]:SWEep[:FREQUency]:RUNNing?.....	1294
[[:SOURce<hw>]:SWEep[:FREQUency]:SHAPE.....	1293
[[:SOURce<hw>]:SWEep[:FREQUency]:SPACing.....	1292
[[:SOURce<hw>]:SWEep[:FREQUency]:STEP:LOGarithmic.....	1294
[[:SOURce<hw>]:SWEep[:FREQUency]:STEP[:LINear].....	1294
{[TRACE] LIST [#]: Pos0:State0; Pos1:State1; ...PosN-1:StateN-1}.....	343
{[TRACE] LIST [#]: Pos0:State0; Pos1:State1; ...PosN-1:StateN-1}.....	352
{BURST LIST [#]: Pos0:State0; Pos1:State1; ...PosN-1:StateN-1}.....	343
{BURST LIST [#]: Pos0:State0; Pos1:State1; ...PosN-1:StateN-1}.....	352
{CLOCK: frequency}.....	339
{COMMENT: string}.....	338
{CONTROL LENGTH: ControlLength}.....	339
{CONTROL LENGTH: ControlLength}.....	351
{CONTROL LIST WIDTH4–Length: #m0m1...mx...mM-1}.....	349
{COPYRIGHT: string}.....	338
{CW MODE LIST [#]: Pos0:State0; Pos1:State1; ...PosN-1:StateN-1}.....	343
{CW MODE LIST [#]: Pos0:State0; Pos1:State1; ...PosN-1:StateN-1}.....	352
{DATA BITLENGTH: BitLength}.....	350



{DATA LIST-Length: #d0d1...dx...dN-1...}	350
{DATE: yyyy-mm-dd;hh:mm:ss}	338
{EMPTYTAG-Length: #EmptySequence}	340
{HOP LIST [#]: Pos0:State0; Pos1:State1; ...PosN-1:StateN-1}	343
{HOP LIST [#]: Pos0:State0; Pos1:State1; ...PosN-1:StateN-1}	352
{LEVATT LIST [#]: Pos0:State0; Pos1:State1; ...PosN-1:StateN-1}	343
{LEVATT LIST [#]: Pos0:State0; Pos1:State1; ...PosN-1:StateN-1}	352
{LEVEL OFFS: RMSOffset_dB,PeakOffset_dB}	341
{MAP LIST [#]: Pos0:State0; Pos1:State1; ...PosN-1:StateN-1}	343
{MAP LIST [#]: Pos0:State0; Pos1:State1; ...PosN-1:StateN-1}	352
{MARKER LIST [#]: Pos0:State0; Pos1:State1; ...PosN-1:StateN-1}	343
{MARKER LIST [#]: Pos0:State0; Pos1:State1; ...PosN-1:StateN-1}	352
{MARKER MODE [#]: GENERATOR}	342
{MWV_SEGMENT_CLOCK_MODE: Mode}	347
{MWV_SEGMENT_CLOCK: ClockSeg0, ClockSeg1, ..., ClockSegN-1}	347
{MWV_SEGMENT_COUNT: NumOfSeg}	346
{MWV_SEGMENT_DURATION: SegDur0, SegDur1, ..., SegDurN-1}	346
{MWV_SEGMENT_FILES: "FileNameSeg0.wv", "FileNameSeg1.wv", ..., "FileNameSegN-1.wv"}	349
{MWV_SEGMENT_LENGTH: SamplesSeg0, SamplesSeg1, ..., SamplesSegN-1}	346
{MWV_SEGMENT_LEVEL_MODE: Mode}	347
{MWV_SEGMENT_LEVEL_OFFS: RMSOffs_dBSg0,PeakOffs_dBSg0, ..., RMSOffs_dBSgN-1, PeakOffs_dBSgN-1}	348
{MWV_SEGMENT_SETTINGS_FILE: SegSettingFilePath}	348
{MWV_SEGMENT_START: SampleStartOffsetSeg0, SampleStartOffsetSeg1, ..., SampleStartOffsetSegN-1}	346
{MWV_SEGMENTx_COMMENT: text}	349
{SAMPLES: Samples}	343
{TYPE: magic, xxxxxxxx}	337
{WAVEFORM-Length: #I0Q0I1Q1...IxQx...IN-1QN-1...}	344
*CLS	899
*ESE	899
*ESR?	899
*IDN?	899
*IST?	900
*OPC	900
*OPT?	900
*PRE	900
*PSC	901
*RCL	901
*RST	901
*SAV	901
*SRE	902
*STB?	902
*TRG	902
*TST?	902
*WAI	903
DIAGnostic:HUMS:DELeTe:ALL	926
DIAGnostic:HUMS:DEViCe:HISTory:DELeTe:ALL	927
DIAGnostic:HUMS:DEViCe:HISTory?	927
DIAGnostic:HUMS:FORMat	928

DIAGnostic:HUMS:SAVE.....	928
DIAGnostic:HUMS:STATe.....	928
DIAGnostic:HUMS:TAgS:ALL?.....	928
DIAGnostic:HUMS:TAgS:DELeTe.....	929
DIAGnostic:HUMS:TAgS:DELeTe:ALL.....	929
DIAGnostic:HUMS:TAgS[:VALue].....	929
SYSTem:COMMunicate:REST:ENABle.....	930
SYSTem:COMMunicate:SNMP:COMMunity:RO.....	930
SYSTem:COMMunicate:SNMP:COMMunity:RW.....	930
SYSTem:COMMunicate:SNMP:CONtAct.....	931
SYSTem:COMMunicate:SNMP:LOCation.....	931
SYSTem:COMMunicate:SNMP:USM:USER.....	931
SYSTem:COMMunicate:SNMP:USM:USER:ALL?.....	932
SYSTem:COMMunicate:SNMP:USM:USER:DELeTe.....	932
SYSTem:COMMunicate:SNMP:USM:USER:DELeTe:ALL.....	932
SYSTem:COMMunicate:SNMP:VERSIon.....	933

# Index

## Symbols

/var/user directory .....	904
/var/volatile directory .....	904
&GTL .....	872
&LLO .....	872
&NREN .....	872
1x8x2	
Abbreviation meaning .....	102
1xEV-DO .....	221
3GPP FDD .....	220
5G NR .....	222
8x8 MIMO	
Connecting .....	204
How to .....	204
Test setup .....	204
50 - Extern reference out of range or disconnected .....	1343
140 - This modulation forces other modulations off .....	1343
180 - Adjustment failed .....	1343
182 - Adjustment data missing .....	1343
183 - Adjustment data invalid .....	1343
200 - Cannot access hardware .....	1343
201 - Hardware revision out of date .....	1343
202 - Cannot access the EEPROM .....	1343
203 - Invalid EEPROM data .....	1343
204 - river initialization failed .....	1343
241 - No current list .....	1343
242 - Unknown list type specified .....	1343
261 - Waveform Protected .....	1343
460 - Cannot open the file .....	1343
461 - Cannot write file .....	1343
462 - Cannot read file .....	1343
463 - Filename missing .....	1344
464 - Invalid filename extension .....	1344
465 - File contains invalid data .....	1344

## A

Abort	
Tutorial .....	99
About	
ALC states and their effects .....	584
Attenuator .....	581
Local oscillator .....	500
Power-On/EMF .....	740
Reference oscillator .....	491
UCOR .....	588, 589
Accept	
MCCW .....	414
Security settings .....	804
Accept carrier table .....	414
Access configuration menu	
Graphics .....	634
Access modes	
Overview .....	817
Accidental trigger	
Avoiding .....	240
Accurate level measurement	
Measurement period .....	116
Active connections	
Remote access settings .....	838
Active elements .....	91

Add LAN sensor	
NRP sensor mapping .....	616
Add sensor	
NRP sensor mapping .....	616
Add USBTMC sensor	
NRP sensor mapping .....	617
Add, change, delete	
User key action .....	770
Additive noise .....	433
Address	
GPIB interface .....	835
Adjust	
BB input signal .....	156, 163
Display and keyboard .....	737
Display settings .....	736
External frequency converter .....	1369
I/Q modulator .....	1369
Keyboard settings .....	736
Adjustment frequency	
Reference oscillator .....	496
Adjustments	
All .....	1368
All delayed .....	1370
Continue .....	1370
Delay settings .....	1370
Information .....	1369
Last full adjustment .....	1368
Log debug info .....	1370
Settings .....	1368
Shutdown .....	1371
Warm up time .....	1371
Advanced configuration	
LXI .....	856
ALC	
About .....	584
Detector sensitivity .....	587
Driver amplifier .....	587
Mode .....	587
Requirements .....	585
Sample level .....	588
Settings .....	586
State .....	586
ALC states and their effects .....	584
Alphanumeric keys	
Front panel keyboard .....	739
Alphanumeric values	
Entering .....	94
AM	
Deviation mode .....	563
Overview .....	579
Ratio .....	564
Subsystem .....	1037
Total deviation .....	564
Amplitude modulation .....	557, 563
Depth .....	563
Deviation mode .....	563
Ratio .....	564
Sensitivity .....	563
State .....	559
Subsystem .....	1037
Analog modulation	
Options .....	548
Overview .....	578

- RF signal ..... 546
  - Signal shape ..... 554
  - Signal source ..... 549
  - Signal sources (external) ..... 549
  - Signal sources (internal) ..... 549
  - Analog wideband I/Q input ..... 468
  - Angle alpha
    - AQPSK ..... 277
  - Annotation
    - Disable amplitude display ..... 798
    - Disable frequency display ..... 798
    - Disable level ..... 798
  - Aperture time
    - Power sensors ..... 614
  - Appearance
    - Settings ..... 739
    - Setup ..... 736
  - Append
    - Blank segment ..... 372
    - Sequencing play list ..... 378
    - Waveform ..... 371
  - Appendix
    - RF hardware versions ..... 1397
  - Application
    - External digital signal ..... 112
  - Application cards ..... 26
  - Application notes ..... 26
  - Apply
    - Assistant settings ..... 405
    - External analog signal ..... 112, 211
    - External digital baseband signal ..... 210
    - External digital signal ..... 111
    - Fading and baseband configuration ..... 126
    - Settings of external RF and I/Q instrument ..... 141
  - Apply and connect
    - Settings of external RF and I/Q instrument ..... 142
  - APSK
    - Code rate ..... 278
    - Gamma ..... 278
  - ARB ..... 80
    - Play list ..... 360
    - Sequencer mode ..... 360
    - Subsystem ..... 1092
    - Test generator selftest file ..... 1376
  - ARB multicarrier
    - Conflict ..... 403
    - Mode ..... 395
  - ARB sequencer mode ..... 361, 375
  - ARbitrary waveform generator ..... 302
  - Arm trigger
    - DM ..... 255
  - Armed\_Auto
    - Common settings ..... 253
    - DM ..... 253
  - Armed\_Retrigger
    - Common settings ..... 253
    - DM ..... 253
  - Arrow keys ..... 43
  - ASK depth ..... 277
  - ATN ..... 1395
  - Attention ..... 1395
  - Attenuation ..... 282
    - Attenuator settings ..... 583
  - Attenuation active
    - Attenuator settings ..... 583
  - Attenuator
    - About ..... 581
    - RF signal ..... 581
    - Settings ..... 582
  - Attenuator settings
    - Attenuation ..... 583
    - Attenuation active ..... 583
    - Level range ..... 489, 583
    - Mode ..... 582
    - RF OFF mode ..... 583
  - Auto
    - Common settings ..... 253
    - DM ..... 253
  - Auto level set ..... 157, 164
  - Auto once
    - Power sensors ..... 613
    - Power viewer ..... 613
  - Automatic level control
    - Detector sensitivity ..... 587
    - Driver amplifier ..... 587
    - Mode ..... 587
    - Readjust internal switch position ..... 489
    - RF signal ..... 584
    - Sample level ..... 588
    - Settings ..... 586
    - State ..... 586
  - Automation ..... 816
  - Autonegotiation
    - Failed ..... 1345
  - Avahi
    - LAN services ..... 802
  - Average level
    - Power viewer ..... 611
  - Avoiding signal gaps ..... 365
  - Avoiding wrap-around ..... 365
  - AWGN
    - Additive white Gaussian noise ..... 424
    - Coupled streams ..... 430
    - Subsystem ..... 1016
  - AWGN mode ..... 433
  - AWGN test signal ..... 305
- ## B
- B x T
    - DM ..... 279
  - Bandwidth
    - Cosine filter ..... 279
    - Modulation input ..... 574
    - Noise generator ..... 575
  - Baseband
    - Channel ..... 163
    - Input ..... 81
    - Output ..... 81
    - Selftest ..... 1374
  - Baseband connection selftest ..... 1373
  - Baseband gain (I/Q)
    - I/Q modulation ..... 470
  - Baseband generator ..... 80
  - Baseband I/Q signal
    - Level ..... 650
  - Baseband Input
    - See BB Input ..... 151
  - Baseband level
    - Info ..... 650
  - Baseband only
    - Mandatory setting ..... 282

- Baseband power levels
  - Querying ..... 645
  - Surveillance ..... 646
- Baseband power measurement
  - Burst signal ..... 657, 659
  - Different duty cycles ..... 659
  - Non-burst signal ..... 654
- Baseband selftest ..... 1374
- Baseband signal
  - Shifting quickly in RF domain ..... 422
- Baseband source configuration
  - Settings ..... 125
- Basebands
  - Common triggering ..... 236
- Basic workflow
  - Multi-segment waveform ..... 382
- Basics
  - Editor ..... 543, 595
  - Export list files ..... 598
  - Fill with sensor list files ..... 596
  - Import list files ..... 598
- Baud rate
  - RS232 interface ..... 835
- BB input ..... 81
- BB output ..... 81
- BB signals ..... 123
- BBIN ..... 151
- BBMM
  - External RF and I/Q settings ..... 132
- Beamforming
  - How to ..... 203
- BeiDou ..... 223
- Bench top, placing ..... 29
- Bias
  - I/Q OUT ..... 181
- Binary data
  - Edit, rules ..... 335
- Bit energy to noise power density ..... 437
- Bit rate ..... 436
- Blank segment ..... 371
- Block diagram
  - Display ..... 89
- Blue LED
  - State indication (active) ..... 165
- Bluetooth®
  - 5.x ..... 220
  - BR ..... 220
  - EDR ..... 220
  - LE ..... 220
- Board and connector number ..... 132
- Broadcast standards ..... 223
- Brochures ..... 26
- Browser settings
  - LXI ..... 853
- Burst gate ..... 229
- Bytes order
  - Definition ..... 938
- C**
- C-List
  - See control list ..... 284, 332
- Calibrate
  - Touchscreen ..... 1361
- Calibrate RF output level with power sensor ..... 617
- Calibration certificate ..... 26
- CALibration subsystem ..... 917
- Carrier
  - Delay ..... 402
  - Frequency ..... 402
  - Gain ..... 402
  - Index ..... 402
  - State ..... 402
  - State start/stop ..... 404
- Carrier + Interferer
  - PEP ..... 439
- Carrier + Noise
  - PEP ..... 439
- Carrier graph ..... 406, 414
- Carrier leakage
  - Impairments ..... 454
- Carrier power ..... 437
- Carrier range ..... 413
- Carrier spacing ..... 396, 411
- Carrier table ..... 414
- Carrier table assistant
  - Carrier range ..... 413
  - First carrier ..... 413
- Carrier/Noise ratio ..... 437
- Carrying the instrument ..... 28
- Cascading
  - LO ..... 663
  - Reference frequency ..... 663
- Catch range
  - NRP power control ..... 608
- CCDF diagram ..... 626
- CCDF display ..... 626
- CDMA2000 ..... 221
- Center frequency
  - Changing without adjusting the RF ..... 422
- Center frequency offset ..... 434
- Central storage
  - Accessing ..... 730
- Change
  - GPIO address ..... 863, 871
- Change password
  - Setup (security) ..... 806
- Change user password
  - Setup (security) ..... 805
- Channel
  - Name ..... 162, 170
  - Number per HS DIG I/Q ..... 126
  - State ..... 172
  - Stream ..... 170
- Channel aggregation bandwidth ..... 125
- Check display screen
  - Display screen test ..... 1366
- Check front panel
  - Key panel test ..... 1362
  - LED test ..... 1363
  - Performing ..... 1361
  - Settings ..... 1361
  - Touchscreen calibration ..... 1362
- Check touch panel
  - Touchscreen test ..... 1364
- Checking the instrument ..... 28
- Clean
  - List of external instrument ..... 137
- Cleaning ..... 1357
- Clear
  - NRP sensor mapping ..... 616
  - RF output protection ..... 584
  - User menu ..... 768

- Clear history
  - Undo/Redo ..... 811
- Clear status
  - Remote ..... 899
- Clipping ..... 396
- CList
  - See control list ..... 288, 332
- Clock
  - Connectors ..... 227
  - Frequency ..... 312
  - Rate ..... 312
- Clock local connector
  - see T/M/(C) ..... 745
- Clock mode
  - DM ..... 260
- Clock rate
  - Blank segment ..... 372
- Clock rate mode
  - Multi-segment waveform ..... 373
- Clock signal
  - External ..... 227
  - Internal ..... 227
- Clock source ..... 260
  - External ..... 227
  - Internal ..... 227
- CLOCK subsystem ..... 922
- Clock to data
  - Deviation ..... 274
- Clock, but
  - Extern serial data ..... 274
- Close
  - Show SCPI command ..... 875
- Closed connections
  - Remote access settings ..... 839
- CODER
  - External RF and I/Q settings ..... 132
- Coding
  - DM ..... 270
- Combination mode ..... 129
- Combined sweep
  - Spacing ..... 529, 531
- Command sequence
  - Remote ..... 903
- Commands of all settings
  - SCPI list ..... 711
- Comment ..... 368
- Common trigger settings ..... 253, 750
- Common triggering
  - 2xSISO with 1xFading simulator ..... 243
  - Basebands ..... 243
- Compensation
  - Group delay, filter effect ..... 175
- Complementary cumulative distribution function ..... 626
- Configuration
  - Restoring ..... 712
  - Restoring instrument settings ..... 708
- Configuration list
  - Multi-segment waveform ..... 362
- Configuration task
  - Support ..... 118
- Configure
  - Control signal ..... 286
- Configure remote access ..... 861
- Configuring
  - GUI appearance ..... 739
- Configuring LAN services ..... 800
- Confirm user password
  - Setup (security) ..... 805, 806
- Conflict ..... 403
- Connect
  - External RF and I/Q instrument ..... 142
  - R&S EX-IQ-BOX ..... 213
- Connect all remote ..... 131
- Connect remote instruments
  - Keep connection on preset ..... 132
  - On start-up ..... 131
- Connected device ..... 154, 161, 169
- Connecting
  - Keyboard ..... 33
  - LAN ..... 32
  - Memory stick ..... 33
  - Mouse ..... 33
  - Power ..... 32
  - To HS DIG I/Q ..... 36
  - To LO IN/LO OUT ..... 36
  - To REF IN/REF OUT ..... 36
  - To RF ..... 35
  - To RF coaxial connectors ..... 34
  - USB devices ..... 33
- Connecting external instruments
  - Overview ..... 100
- Connecting to RF coaxial connectors
  - To connect to pluggable connectors ..... 35
  - To connect to screwable connectors ..... 34
  - To prepare for connecting ..... 34
- Connection fault
  - 169.254.\*.\* ..... 1345
- Connector
  - AC power supply ..... 50
  - ADV CLK ..... 52
  - ADV TRG ..... 52
  - Baseband ..... 745
  - CLOCK ..... 50
  - Control signal ..... 52
  - Data ..... 52
  - DIFF I/Q ..... 52
  - Differential output ..... 52
  - Digital IQ ..... 51
  - Direction ..... 184, 754, 758
  - Display ..... 50
  - DVI ..... 50
  - EFC ..... 49
  - EXT ..... 51
  - Find ..... 144
  - Find out ..... 109, 184
  - Global ..... 743, 754
  - GPIB ..... 49
  - High-speed digital IQ ..... 52
  - I ..... 44, 48, 52
  - I Bar ..... 52
  - Identify ..... 109, 144
  - Identify (how to) ..... 184
  - IEC/IEEE ..... 49
  - INST TRIG x ..... 51
  - LAN ..... 50
  - LED ..... 109
  - LF OUT x ..... 51
  - LO IN ..... 49
  - LO OUT ..... 49
  - Local ..... 745, 758
  - Localize ..... 184
  - Mapping ..... 743
  - MARKER ..... 50

- Q ..... 44, 48, 52
  - Q Bar ..... 52
  - REF IN ..... 48
  - REF OUT ..... 48
  - RF A/RF B ..... 45, 48
  - SENSOR ..... 44
  - Shared ..... 743
  - Show ..... 109, 144, 184
  - Signal ..... 754, 758
  - Single-ended output ..... 52
  - Synchronization ..... 52
  - T/M ..... 50
  - T/M/C ..... 50, 758
  - TRIGGER ..... 50
  - USB ..... 44, 50
  - USB Device ..... 50
  - User ..... 743, 754
  - USER ..... 44, 49
  - Connector direction
    - Find out ..... 184
    - Settings ..... 132
  - Connector global
    - Signal, how to define ..... 760
  - Connector local
    - Signal, how to define ..... 760
  - Connectors ..... 45
    - Sharing ..... 745
  - Constant I/Q test signal ..... 305
    - Settings ..... 317
  - Constellation diagram ..... 624
  - Context-sensitive menu ..... 91
  - Continue
    - Internal adjustments ..... 1370
  - Continue on error
    - Failed internal adjustments ..... 1346, 1347
  - Continuous measurements ..... 654
  - Control bus ..... 1395
  - Control list
    - ASCII format ..... 288, 332
    - Binary format ..... 333
    - Edit, rules ..... 335
    - How to assign ..... 290, 333
    - Manually (Control data editor) ..... 288
    - Select ..... 272
    - Select, edit, new ..... 717
    - Tags ..... 332
  - Control signal ..... 229
  - Convert
    - Remote command list ..... 882
  - Copy
    - Instrument settings ..... 721
    - Several files ..... 719, 726, 728
    - Show SCPI command ..... 875
  - Correction data
    - Current ..... 688
  - Counter ..... 1350
  - Couple I/Q bias ..... 180
  - Coupled baseband sources
    - Advantages ..... 107
    - Basics ..... 107
  - Coupled mode
    - Representation of stream state on the block diagram ..... 430
  - Coupled trigger settings ..... 253, 750
    - Simultaneous signal generation start ..... 243
  - Coupling
    - Local oscillator ..... 502
  - Coupling mode
    - AM, FM, PhiM ..... 574
    - External modulation input ..... 574
  - Create ..... 369, 399
    - Multicarrier waveforms ..... 391
    - New directory ..... 721
  - Create and load ..... 369, 399
  - Crest factor
    - BB Input ..... 157
    - Channel ..... 163
    - Desired value ..... 412
    - External analog signal ..... 469
    - Match ..... 114
    - Optimize (MCCW) ..... 411
    - Where to find the value ..... 115
  - Crest factor mode ..... 396
  - Current frequency
    - Adjust ..... 1369
    - Sweep ..... 527
  - Current index
    - List mode ..... 536
  - Current level
    - Sweep ..... 527
  - Current segment ..... 380
  - Custom digital modulation ..... 80
  - Customer support ..... 1354
  - Cut
    - Instrument settings ..... 721
  - Cut off frequency factor ..... 279
  - CW
    - Frequency ..... 482
  - CW (continuous wave) ..... 229
  - CW frequency ..... 434, 440
  - CW interferer ..... 433
  - CW mode
    - Output level ..... 486
  - CW signal
    - Generate in baseband ..... 269
    - Settings ..... 479
  - CW/Mod ..... 229
- ## D
- D-List
    - See data list ..... 334
  - Data editor
    - UCOR ..... 593
  - Data entry ..... 94
  - Data format
    - Definition ..... 938
  - Data list ..... 271
    - Access ..... 714
    - Binary format ..... 334
    - Edit, rules ..... 335
    - Editor ..... 282
    - How to assign ..... 291, 335
    - How to create ..... 290, 717
    - How to open ..... 906
    - Manually (data list editor) ..... 290
    - Select ..... 272
    - Select, edit, new ..... 717
    - Standard modulation data source ..... 225
    - Tags ..... 334
  - Data sheets ..... 26
  - Data source
    - Data list ..... 225
    - DM ..... 271

- Extern serial data ..... 271
  - Pattern ..... 225
  - PRBS generator ..... 225
- Data valid ..... 1395
- Datasheet
  - LXI ..... 859
- Date ..... 1359
- DAV ..... 1395
- DC carrier leakage
  - Eliminating ..... 422
  - How to shift baseband signal ..... 422
- Deactivate RF output ..... 493
- Deactivated licenses ..... 776
- Declassification ..... 797
- Default
  - Stream mapping ..... 107
- Default directory
  - Mass memory ..... 904
  - User data ..... 700, 905
- Default settings ..... 395
  - ARB ..... 311
  - DM ..... 268
  - I/Q output analog ..... 178
  - MCCW ..... 410
- Default values
  - Remote ..... 901
- Define
  - User key action ..... 770
- Defining the level setting with the rotary knob ..... 174
- Delay
  - Basebands ..... 313
  - Double pulse (PULM) ..... 568
  - Falling edge of ramp envelope ..... 281
  - Marker ..... 259
  - PULM ..... 568
  - Rising edge of ramp envelope ..... 281
  - Trigger ..... 257
  - Waveform ..... 313
- Delay start ..... 405
- Delay step ..... 405
- Delay time
  - NRP power control ..... 608
- Delete
  - Instrument settings ..... 721
  - List mode file ..... 539
  - Sequencing list ..... 379
  - Waveform ..... 371
- Delete instrument settings ..... 914
- Delta frequency
  - External RF and I/Q instrument ..... 135
- Delta phase
  - RF frequency ..... 490
- Demo
  - How to start ..... 95
- Destination
  - Connection selftest (BNC) ..... 1374
- Detect
  - External instrument ..... 137
- Detector sensitivity
  - Automatic level control ..... 587
- Deviation
  - External data ..... 274
  - Fixed total deviation ..... 561, 562
  - FSK modulation ..... 277
  - PhiM ..... 562
  - Variable FSK ..... 277
- Deviation mode
  - AM ..... 563
  - Amplitude modulation ..... 563
  - FM ..... 561
  - Frequency modulation ..... 561
  - Phase modulation ..... 562
  - PhiM ..... 562
- Device ID ..... 775
  - NRP sensor mapping ..... 617
- Device reset ..... 903
- Device-specific notifications ..... 1342
- Dialog
  - Snapshots ..... 739
- Dialog boxes ..... 93
- Differential coding
  - DM ..... 270
- DIG IQ auto setting ..... 156, 163
- Digital attenuation
  - RF level ..... 487
- Digital I/Q
  - Input ..... 151
- Digital inputs
  - Connector type ..... 161
  - Switching ..... 154, 160
- Digital modulation
  - See DM ..... 266
- Digital only signals
  - Settings ..... 121
- Digital output
  - State ..... 165
- Digital standard ..... 80
  - Supported ..... 220
- Direction
  - Connector ..... 132
- Directory
  - Temporary data ..... 904
  - User data ..... 904
- Disable
  - Frequency display ..... 798
  - Level display ..... 798
- Disconnect all remote ..... 131
- Disk & memory
  - Security settings ..... 795
- Display
  - Active elements ..... 91
  - Block diagram ..... 89
  - Context-sensitive menu ..... 91
  - Info line ..... 91
  - Information ..... 88
  - Lock ..... 798
  - Mapped connectors ..... 131
  - On-screen keypad ..... 91
  - Power sensors ..... 611
  - Screen saver ..... 738
  - Settings ..... 737
  - Setup ..... 737
  - Status bar ..... 88
  - Tab labels ..... 91
  - Taskbar ..... 90
  - USB keyboard ..... 738
  - Wait time (screen saver) ..... 738
- Display correction file data
  - UCOR ..... 593
- Display correction value
  - UCOR ..... 593
- Display permanent
  - Power sensors ..... 611



- Display port
  - Connector (for future use) ..... 50
- Display screen
  - Checking ..... 1366
- Display screen test
  - Perform ..... 1366
- DISPlay subsystem ..... 933
- Display unit ..... 635
- Disposal ..... 1357
- Distortion-free range
  - Max bandwidth ..... 307
  - Resampling ..... 307
- Distribution
  - Noise generator ..... 575
- Diversity
  - Rx ..... 83
  - Tx ..... 83
- DList
  - See data list ..... 334
- DNS server ..... 832
- DNS suffix ..... 832
- Documentation overview ..... 25
- Double pulse delay
  - PULM ..... 568
- Double pulse width
  - PULM ..... 567
- Downgrade information ..... 1352
  - Factory version ..... 1352
  - Min. version ..... 1352
- Drag&Drop blocks
  - How to ..... 106
- Driver amplifier
  - ALC ..... 587
  - Automatic level control ..... 587
- Duplicate streams
  - Fading and baseband configuration ..... 125
- Duration
  - Measurement period external digital signal ..... 116
- DVB-H/T ..... 223
- DVB-RCS2 ..... 223
- DVB-S2/S2X/S2X-E ..... 223
- DVI
  - Connector (for future use) ..... 50
- Dwell time
  - Sweep ..... 529
- Dwell time mode
  - List mode ..... 537
- E**
- EDGE Evolution ..... 220
- Edge form of ramp envelope ..... 281
- Edge slope of ramp envelope ..... 281
- Edit
  - Binary data ..... 335
  - Data list ..... 282
  - Editor ..... 543, 595
  - List mode data ..... 539
  - Ramp in control list ..... 286
  - UCOR data ..... 593
- Editor
  - Basics ..... 543, 595
  - Edit ..... 543, 595
  - Fill with sensor ..... 595
  - Save ..... 543, 595
  - Save as ..... 543, 595
  - Select row ..... 543, 595
- EMF display
  - RF level ..... 740
- Emulation
  - IDN string ..... 838
  - Language ..... 837
  - Mode ..... 837
  - Set IDN and OPT to default ..... 837
- EMV ..... 223
- Enable
  - LAN interface ..... 802
- Enable registers
  - Remote ..... 901
- Enhanced features TD-SCDMA ..... 221
- Enter license key ..... 775
- Enter password
  - Setup (security) ..... 804
- Entity ..... 123
- ENTity
  - Meaning ..... 896
- Envelope tracking power amplifiers tests ..... 179
- EOI ..... 1395
- Error log ..... 1353
- Error message
  - Missing burst gate marker in waveform file, please disable RF power ramping. .... 311
  - No or empty waveform file ..... 311
- Error messages ..... 1344
  - Adjustment data invalid (183) ..... 1343
  - Adjustment data missing (182) ..... 1343
  - Adjustment failed (180) ..... 1343
  - Cannot access hardware (200) ..... 1343
  - Cannot access the EEPROM (202) ..... 1343
  - Cannot open file (460) ..... 1343
  - Cannot read file (462) ..... 1343
  - Cannot write file (461) ..... 1343
  - Driver initialization failed (204) ..... 1343
  - Extern reference out of range or disconnected (50) ..... 1343
  - File contains invalid data (465) ..... 1344
  - Filename missing (463) ..... 1344
  - Hardware revision out of date (201) ..... 1343
  - Invalid EEPROM data (203) ..... 1343
  - Invalid filename extension (464) ..... 1344
  - No current list (241) ..... 1343
  - SCPI ..... 1342
  - See notifications ..... 1341
  - This modulation forces other modulations off (140) ..... 1343
  - Unknown list type specified (242) ..... 1343
  - Waveform Protected (261) ..... 1343
- EUTRA/LTE ..... 222
- Event status enable register (ESE)
  - Remote ..... 899
- Event status register (ESR)
  - Remote ..... 899
- Exchanging RF port ..... 1377
- Exclude frequency ..... 712
- Exclude level ..... 712
- Execute
  - Baseband selftest ..... 1374
  - Next segment ..... 382
  - Occupation ..... 779
  - Single sweep ..... 530
  - Trigger (list mode) ..... 538
- Execute single
  - NRP power control ..... 608
- Expiration date of option ..... 1352

- Export
  - Execute ..... 541, 600
  - SCPI ..... 718
  - SCPI export ..... 878
  - SCPI list ..... 876
  - SCPI settings ..... 876
- Export deactivation response ..... 776
- Export license key ..... 776
- Export list files
  - Basics ..... 598
- Express level in
  - Volts ..... 1264
- Extended RF ..... 188
- Extern serial data
  - Bit clock slope ..... 274
  - Bit order ..... 274
  - Deviation, clock to data ..... 274
  - Graphical illustration ..... 275
  - t\_hold ..... 226
  - t\_setup ..... 226
- External
  - Clock reference ..... 227
  - Signal sources (analog modulation) ..... 549
- External analog signal
  - Apply ..... 112
  - Apply (how to) ..... 211
  - Feed to the instrument ..... 112
- External clock
  - Monitoring ..... 261
- External digital signal
  - Application fields ..... 112
  - Apply ..... 111, 151
  - Apply (how to) ..... 210
  - Baseband input ..... 151
  - Feed to the instrument ..... 111
  - Input ..... 154, 160
  - Interface type ..... 161
  - Possible applications ..... 112
  - Required if ..... 112
  - Source ..... 154, 160
- External fading ..... 208
- External frequency
  - Reference oscillator ..... 493
- External frequency converter
  - Adjust ..... 1369
- External instrument
  - Detect ..... 137
  - Remote instrument settings ..... 136
  - Scan ..... 137
  - Settings ..... 133, 136
- External RF and I/Q
  - Alias name ..... 138
  - Connecting to QSFP+ interface ..... 197, 672
  - Connecting, analog interface ..... 189
  - Connecting, digital interface ..... 192
  - Connecting, R&S SZU ..... 195
  - How to ..... 189
  - Settings ..... 129
- External RF and I/Q instruments
  - Basics ..... 108
  - Control ..... 108, 696
- External trigger
  - Common source ..... 678
  - Configuring ..... 678
  - Providing the instrument with ..... 678
- External Trigger Delay
  - DM ..... 257
- Eye diagram ..... 625
- F**
- Factory
  - Preset ..... 705
- Factory preset
  - Change GPIB address ..... 863
  - GPIB address ..... 871
- Factory version
  - Firmware ..... 1352
- FADER
  - External RF and I/Q settings ..... 132
- Fading ..... 81
  - MIMO ..... 118
  - See also the user manual "Fading Simulator" ..... 105
- Fading and baseband configuration
  - How to ..... 185
  - Settings ..... 119
- Fading application ..... 208
- Fading bandwidth ..... 124
- Fading configuration ..... 118
  - Settings ..... 122
- Fading/Baseband configuration
  - Overview ..... 106
- Fall delay ..... 281
- Feedback
  - Connector ..... 754, 758
  - Signal ..... 754, 758
- Feeding
  - External analog signal ..... 112
  - External digital signal ..... 111, 151
- File
  - Multicarrier table ..... 402
  - SCPI export ..... 877
  - Waveform ..... 312
- File catalog
  - List mode ..... 539
- File content
  - SCPI export ..... 878
- File contents
  - Multi-segment waveform ..... 369
- File handling ..... 701
- File list ..... 910
- File manager ..... 719
- File name ..... 732
- File select
  - Dialog ..... 714
- File server
  - Data exchange ..... 730
- File sharing ..... 725
- File storage location ..... 905
- File system ..... 699
  - Accessing ..... 725
- File transfer ..... 701
  - From file server ..... 730
  - FTP/SAMBA ..... 816
  - How to ..... 725
- File type selection ..... 720
- Files
  - User data ..... 699
- Fill
  - User correction data ..... 543, 595
- Fill table
  - Automatically ..... 543, 595
  - UCOR ..... 593

- Fill with sensor
  - Basics ..... 596
  - Editor ..... 595
- Filter
  - DM ..... 279
  - Power sensors ..... 612
- Filter cut off frequency ..... 397
- Filter effects
  - Compensation ..... 175
- Filter length
  - Auto ..... 613
  - User-defiend ..... 613
- Filter parameter
  - B x T ..... 279
  - Cut off frequency factor ..... 279
  - Gauss cut off frequency ..... 279
  - Impact ..... 248
  - Lowpass cut off frequency ..... 279
  - Roll off factor ..... 279
- Finding out the default directory ..... 700, 905
- Firmware
  - Factory version ..... 1352
  - Min. version ..... 1352
  - Version ..... 1351
- Firmware options
  - see software options ..... 80
- Fixed
  - Frequency ..... 482
- Fixed mode
  - I/Q out ..... 180
- Flexible dynamic switch over ..... 383, 384
  - Without signal interruptions ..... 384
- Floating
  - License server ..... 780
- Floating licenses ..... 1352
- FM
  - Deviation ..... 560
  - Deviation mode ..... 561
  - Mode ..... 561
  - Ratio ..... 561
  - Subsystem ..... 1041
  - Total deviation ..... 561
- Format
  - SCPI Export ..... 877
- FORMat subsystem ..... 937
- FPGA/μC
  - Update ..... 1377
- Frequency
  - Annotation disable ..... 798
  - CW, fixed ..... 482
  - LF generator ..... 572
  - LF sweep ..... 572
  - Multiplier ..... 483
  - Offset ..... 482
  - Overrange active ..... 484
  - Overrange of R&S SZU ..... 484
  - Power sensors ..... 612
  - RF signal ..... 481
  - Test generator selftest ..... 1376
  - Test signal ARB ..... 314
  - UCOR ..... 593
- Frequency modulation ..... 557, 560
  - Deviation mode ..... 561
  - Mode ..... 561
  - Ratio ..... 561
  - State ..... 559
  - Subsystem ..... 1041
- Frequency offset
  - Between the I/Q streams ..... 127
  - External signal ..... 421
  - Internal signal ..... 421
- Frequency range
  - Overrange ..... 484
- Frequency, internal
  - AM ..... 572
  - FM ..... 572
- Front panel
  - Checking ..... 1360
- Front panel test
  - Performing ..... 1361
- FSK deviation ..... 277
- FSK type
  - Variable FSK ..... 277
- FTP
  - How to access the instrument ..... 725
  - LAN services ..... 802
- Function keys
  - Overview ..... 41
- G**
- Gain
  - External signal ..... 422
  - Impairment ..... 450
  - Internal signal ..... 422
  - Test generator selftest ..... 1376
- Gain Imbalance ..... 450
- Gain start ..... 404
- Gain step ..... 404
- Galileo ..... 223
- Gated measurements ..... 657
- Gateway ..... 832
- Gauss cut off frequency ..... 279
- General
  - Blank segment ..... 371
  - General configuration of instrument ..... 736
- General instrument functions
  - Checking parameters and dependencies ..... 761
  - User key ..... 763
  - User menu ..... 763
- General instrument settings ..... 736
- General workflow
  - Multi-segment waveform ..... 382
- Generate test signal
  - HD ..... 315, 316, 317
  - RAM ..... 315, 316, 317
- Generating
  - LTE 2x8 MIMO signal ..... 203
  - LTE 4x4 MIMO signal ..... 189
  - Time aligned signals ..... 667
- Generating an unmodulated signal ..... 479
- Generating LTE with 4x4 MIMO signal ..... 185, 187, 188
- Generating short sequences ..... 240
- Getting started ..... 25
- Global connectors
  - Set connector default settings ..... 568
- Global dwell time
  - List mode ..... 537
- GLONASS ..... 223
- GNSS ..... 223
- GPIB
  - Address ..... 835
  - Change address ..... 863, 871
  - Channel address ..... 834

- Characteristics ..... 822
- Interface ..... 822
- Set up remote control ..... 871
- Visa resource string ..... 834
- GPIB address
  - Factory preset ..... 871
- GPS ..... 223
- Graphics
  - Number of samples ..... 632
- Grey LED
  - State indication (inactive) ..... 165
- Group delay
  - Compensation ..... 175
- GSM AM suppression test
  - Settings ..... 125
- GSM/EDGE ..... 220
- GUI
  - Setting ..... 741
- GUI update
  - Setup ..... 736
- H**
- Hard copy
  - Create, how to ..... 734
  - File format ..... 732, 733
  - Print, how to ..... 734
- Hard disk drive ..... 49
- Hardcopy ..... 731
  - Options ..... 732
- Hardware channel
  - External RF and I/Q ..... 138, 139
- Head panel
  - See Status bar ..... 40
- Header
  - See Status bar ..... 40
- Health and utilization
  - LXI ..... 859
- Help ..... 25, 95
- High-speed switch over
  - How to ..... 385
- Higher bit modulation
  - Bit order ..... 274
- Higher MIMO modes ..... 84
- Higher-order MIMO testing ..... 84
- HiSlip
  - Visa resource string ..... 833
- HiSLIP
  - Resource string ..... 819
- History
  - Undo/Redo ..... 811
- Host name
  - NRP sensor mapping ..... 616
- Hostname ..... 831
  - External RF and I/Q ..... 139
  - LXI ..... 852
  - RF ports setup ..... 694
- Hotspot ..... 90
- How to
  - Accessing RF settings ..... 476
  - Activate RF signal output ..... 478
  - Calibrate RF output level with power sensor ..... 617
  - Change the default directory ..... 906
  - Checking hardware options ..... 1348
  - Checking RF assembly ..... 1348
  - Internal adjustments ..... 1371
  - Resolve adjustments errors ..... 1346
  - Run delayed adjustments ..... 1372
  - Set RF frequency and level ..... 479
  - Use an complete file path ..... 906
  - User key ..... 767
  - User menu ..... 765
- How to:
  - Enable VNC ..... 885
  - Remote control with LXI browser ..... 864
  - Return to manual operation ..... 873
- HRP UWB 802.15.4 ..... 221
- HSPA ..... 220
- HSPA+ ..... 220
- HTTP
  - LAN services ..... 802
- HUMS ..... 840
  - About ..... 840
  - Add device tags ..... 851
  - Delete device tag entry ..... 850
  - Delete device tags ..... 851
  - Delete history ..... 842
  - Device ID ..... 850
  - Device tag key ..... 850
  - Device tag value ..... 850
  - Device tags ..... 849
  - Enhanced settings ..... 842, 843
  - Export history ..... 842
  - LXI ..... 859
  - Protocol settings ..... 843
  - REST ..... 844
  - SNMP protocol ..... 844
  - SNMPv2 access ..... 845
  - SNMPv2 community ..... 845
  - SNMPv2 configuration ..... 844
  - SNMPv3 user ..... 845
  - State ..... 842
- I**
- I offset ..... 451
- I/Q
  - External RF and I/Q settings ..... 132
- I/Q connection
  - Status ..... 133
- I/Q delay
  - Impairments, digital ..... 456
- I/Q diagram ..... 623
- I/Q Impairments
  - Linear ..... 449
- I/Q mod
  - Input signal ..... 468
- I/Q modulation ..... 458, 466
  - Gain ..... 470
  - Performance optimization ..... 470
- I/Q modulator
  - Adjust for current settings ..... 474
  - Digital headroom ..... 473
  - General settings ..... 467
  - I/Q modulator state ..... 472
  - Optimization characteristics ..... 472
  - Optimizations ..... 472
  - Optimizations settings ..... 471
- I/Q OUT
  - Enabling ..... 190
- I/Q output
  - RF envelope ..... 179
- I/Q output analog
  - Settings ..... 176

- I/Q output digital
  - Settings ..... 164
- I/Q output stream mapper
  - Overview ..... 105
- I/Q output type
  - Differential ..... 140, 179
  - Envelope, E ..... 140, 179
  - Inverted envelope, E BAR ..... 140, 179
  - Single ended ..... 140, 179
- I/Q skew
  - Impairments, digital ..... 455
- I/Q stream mapper
  - Basics ..... 107
  - How to ..... 187
  - Settings ..... 127
- I/Q streams
  - Add ..... 129
- I/Q swap ..... 468
- I/Q Swap ..... 154
- I/Q wideband ..... 469
- Identification
  - Emulation mode ..... 837
  - Remote ..... 899
- Identify
  - Connector ..... 144
- Identify connector
  - Setting ..... 144
- IDN string
  - Emulation mode ..... 838
- IEC/IEEE bus interface
  - Channel address ..... 834
- IEEE 802.11a/b/g/n ..... 221
- IEEE 802.11ac ..... 221
- IEEE 802.11ad ..... 221
- IEEE 802.11ax ..... 221
- IEEE 802.11ay ..... 221
- IEEE 802.11be ..... 221
- IEEE 802.11p/j ..... 221
- IEEE 802.16 WiMAX ..... 222
- IFC ..... 1395
- Image rejection
  - Test signal ..... 416
- Imbalance
  - Impairments ..... 454
- Impairment
  - Analog ..... 449
  - Digital ..... 449
  - Linear ..... 449
- Impairments
  - Analog ..... 452
  - Digital ..... 452
- Impedance
  - External modulation source ..... 574
  - Pulse modulation ..... 559
- Import
  - Execute ..... 541, 600
  - SCPI ..... 718
- Import license key ..... 776
- Import list files
  - Basics ..... 598
- Import/Export
  - Lists ..... 540
  - Select file ..... 541, 599, 600
- Inactive licenses ..... 776
- Index
  - List mode ..... 536
- Info line ..... 91, 1344
- Information
  - Internal adjustments ..... 1369
- Inhibit trigger ..... 241
- Input
  - Clock slope ..... 274, 757, 760
  - Impedance Clock/Trigger ..... 757, 760
  - Impedance external modulations ..... 574
  - Pulse impedance ..... 559
  - Pulse polarity ..... 559
  - Pulse threshold ..... 559, 756
  - Threshold Clock/Trigger ..... 756, 759
  - Trigger slope ..... 757, 760
- Input connector ..... 44, 48, 49, 51, 52
- Input waveform file ..... 405
- Input/output signals and interfaces
  - Overview ..... 108
- Installed assembly ..... 1350
- Installing
  - R&S DigIConf ..... 213
- Instrument
  - Carrying ..... 28
  - Checking ..... 28
  - Lifting ..... 28
  - Operating site ..... 28, 29
  - Unpacking ..... 28
- Instrument emulations ..... 836
- Instrument help ..... 25
- Instrument name
  - External RF and I/Q instrument ..... 134
- Instrument security procedures ..... 26
- Instrument settings
  - Recall ..... 901, 914
  - Save ..... 901, 916
- Interface
  - Functions (GPIB) ..... 1396
  - GPIB ..... 822
- Interface clear ..... 1395
- Interfaces
  - GPIB ..... 822
  - Physical location ..... 109
  - RS232 ..... 821
  - USB ..... 821
- Interferer
  - CW, generation ..... 424
- Interfering signal
  - Use an external digital signal ..... 112
- Internal
  - Clock reference ..... 227
  - Signal sources (analog modulation) ..... 549
- Internal adjustments
  - How to ..... 1371
- Internal adjustment
  - Continue on error ..... 1347
  - Obtain technical support on error ..... 1347
- Internal adjustments
  - Abort on error ..... 1346
  - About ..... 1357
  - Troubleshooting ..... 1346
- IoT
  - eMTC ..... 222
  - NB-IoT ..... 222
- IP address ..... 819
  - Dynamic ..... 831
  - External RF and I/Q ..... 139
  - LXI ..... 852
  - Not recognized ..... 1345
  - NRP sensor mapping ..... 616

- RF ports setup ..... 694
- Zeroconf ..... 831
- IP address mode ..... 831
- IP configuration
  - LXI ..... 855
- IQ subsystem ..... 1209
- IST flag
  - Remote ..... 900
- J**
- Joint carrier configuration ..... 413
- K**
- Key
  - Backspace ..... 42
  - Diagram ..... 41
  - Down ..... 43
  - Enter ..... 42
  - ESC ..... 42, 43
  - FREQ ..... 41
  - HCOPY ..... 41
  - HELP ..... 41
  - INFO ..... 41, 1344
  - INSERT ..... 42
  - Left ..... 43
  - LEVEL ..... 41
  - LOCAL ..... 41
  - MOD ON/OFF ..... 41, 556
  - NEXT WINDOW ..... 43
  - ON/OFF TOGGLE ..... 41
  - On/Standby ..... 41
  - PRESET ..... 41
  - RESIZE WINDOW ..... 43
  - RF ON/OFF ..... 41
  - Right ..... 43
  - SAVE/RCL ..... 41, 709
  - SETUP ..... 41
  - Up ..... 43
  - USER ..... 41
- Key panel test
  - Check front panel ..... 1362
- Keyboard
  - On-screen ..... 94
  - Setting ..... 741
  - Settings ..... 737
  - Setup ..... 737
  - Subsystem ..... 944
  - Usage ..... 87
- Keypad
  - On-screen ..... 94
  - Overview ..... 42
- Keyword
  - ENTity ..... 896
- L**
- LAN
  - Connecting ..... 32
  - Environment ..... 32
  - Interface ..... 819
  - IP address ..... 819
  - Main services ..... 802
  - Reset ..... 852
  - Samba services ..... 803
  - Services ..... 800
- LAN configuration
  - LXI ..... 855
- LAN interface
  - Avahi ..... 802
  - Enable ..... 802
  - FTP ..... 802
  - HTTP ..... 802
  - LAN over SCPI ..... 802
  - SMB (Samba) ..... 802
  - SSH ..... 802
  - VNC ..... 802
- LAN status
  - LXI ..... 852
- Language
  - Emulation ..... 837
- Last factory calibration ..... 1351
- Last full adjustment
  - Internal adjustments ..... 1368
- Layout
  - USB keyboard ..... 738
- Learn
  - List mode ..... 538
- Learn list mode data
  - List mode ..... 538
- LED test
  - Check front panel ..... 1363
- Length
  - Control list ..... 286
- Lev Att
  - see Level attenuation ..... 229
- LEV\_ATT ..... 282
- Level
  - Annotation disable ..... 798
  - BB Input ..... 157
  - Behavior (RF) ..... 487, 533, 608
  - I/Q output signal ..... 180
  - Noise generator ..... 577
- Level attenuation ..... 229
  - DM ..... 282
- Level default unit
  - Change ..... 1264
- Level in SCPI in V ..... 1264
- Level limit ..... 489, 608
- Level mode
  - Multi-segment waveform ..... 373
- Level offset
  - Power sensors ..... 612
  - RF level ..... 489
  - State (power sensors) ..... 612
- Level range
  - Attenuator settings ..... 489, 583
- Level settings
  - On start-up ..... 740
- LF frequency sweep
  - State ..... 527, 572
- LF generator
  - Shape ..... 572
- LF out
  - Connector ..... 52
- LF Out
  - Overview ..... 579
- LF OUT x
  - R&S SMW-B13/-B13T ..... 51
- LF output
  - Offset ..... 577
  - Period ..... 572
  - Pulse duty cycle ..... 572

- Pulse width ..... 572
  - Shape ..... 572
  - Source ..... 576, 579
  - Sweep reset ..... 530
  - Trapezoid high ..... 573
  - Trapezoid rise, fall ..... 573
  - Triangle rise ..... 573
  - Voltage ..... 576
  - LF Output ..... 575
  - LF signal
    - Shape ..... 554
  - LF sweep
    - Frequency ..... 572
  - License
    - Keys ..... 770
  - License for software option ..... 1352
    - Infos ..... 1352
  - License info
    - Occupy / renew license ..... 779
  - License server
    - Add remote connection ..... 789
    - Enable connection restrictions ..... 788
    - Restrict remote connection ..... 787
  - Licenses ..... 770
    - Server ..... 780
    - Settings ..... 773
    - Trial ..... 771
  - Lifting the instrument ..... 28
  - Limit
    - RF level ..... 489, 608
  - Linearize RF
    - For current settings ..... 474
    - Mode ..... 473
  - List
    - Define ..... 539
    - Range ..... 539
    - State ..... 536
  - List file
    - Catalog ..... 539
  - List mode
    - Create list automatically ..... 543, 595
    - Current index ..... 536
    - Dwell time mode ..... 537
    - Edit ..... 539
    - Execute trigger ..... 538
    - Export user data ..... 541, 600
    - File settings, import/export ..... 541, 599
    - Global dwell time ..... 537
    - Import/export ..... 540, 599
    - Learn list mode data ..... 538
    - Load from file ..... 541, 599
    - Load user data ..... 540
    - Reset ..... 538
    - Select file ..... 539
    - Settings ..... 535
    - State ..... 536
    - Trigger execute ..... 538
    - Trigger source ..... 536
  - LO
    - Settings ..... 502
  - LO level
    - Adjust ..... 504, 1369
  - LO OUT Frequency
    - Display ..... 504
  - Load
    - See recall ..... 709
    - User filter ..... 280
    - Waveform ..... 312
  - Load instrument settings ..... 901, 914
  - Load list ..... 368
  - Load user mapping ..... 276
  - Loading
    - Trying out ..... 70
  - Local adjustments ..... 474
  - Local connector
    - T/M/(C) ..... 745
  - Local oscillator ..... 500
    - About ..... 500
    - Adjust LO level ..... 504, 1369
    - Mandatory LO in frequency ..... 504
    - Mode ..... 503
    - Options ..... 501
    - Out state ..... 504
    - Settings ..... 502
  - Lock
    - Display ..... 798
  - Log debug info
    - Internal adjustments ..... 1370
  - Lowpass cut off frequency ..... 279
  - LSB/MSB order
    - Definition ..... 938
  - LTE 2x8 MIMO
    - How to ..... 203
  - LTE 4x4 MIMO
    - How to ..... 189
  - LTE advanced ..... 222
  - LTE Rel. 8/Rel. 9/Rel. 10/Rel. 11/Rel. 12/Rel. 13/Rel. 14 ..... 222
  - LTE-A ..... 222
  - LucasFonts
    - RSCorpid EULA ..... 1352
  - LXI
    - Advanced configuration ..... 856
    - Browser settings ..... 853
    - Configuration ..... 891
    - Datasheet ..... 859
    - Health and utilization ..... 859
    - Hostname ..... 852
    - IP address ..... 852
    - IP configuration ..... 855
    - LAN configuration ..... 855
    - LAN status ..... 852
    - MAC address ..... 852
    - Ping ..... 857
    - Remote trace (SCPI) ..... 857
    - Reset (LXI) ..... 852
    - Status settings ..... 851
    - Tracing ..... 864
  - LXI browser
    - Starting remote control ..... 864
  - LxMxN
    - Settings ..... 122
- ## M
- Mac address ..... 832
  - MAC address
    - LXI ..... 852
  - Maintenance ..... 1357
    - PCI-FPGA update ..... 1377
  - Managing license keys ..... 770

- Managing licenses ..... 770
- Mandatory LO in frequency
  - Local oscillator ..... 504
- Manual interaction ..... 87
- Manual operation
  - Security settings ..... 797
- Map network share
  - Settings ..... 720, 721
- Map stream X to connector
  - Settings ..... 128
- Mapping I/Q streams
  - How to ..... 187
- Mapping multiple streams ..... 129
- Mapping network folders ..... 723
- Marker ..... 232
- Marker Delay ..... 259
- MARKER LIST ..... 343, 352
- Marker local connector
  - see T/M(C) and T/M ..... 745
- Marker output signals ..... 231
- Marker positions ..... 287
- Marker trace
  - Periodical ..... 339, 351
- Mass storage location ..... 905
- Matching
  - Crest factor ..... 114
- Maximal deviation
  - Frequency modulation ..... 560
  - PhiM ..... 562
- Maximal frequency
  - Overrange ..... 484
- Maximum overall output voltage ..... 117, 177
- Meaning of
  - LxMxN ..... 102
- Measured external clock ..... 261
- Measured level
  - NRP level control ..... 607
- Measurement
  - Acquisition ..... 651
  - Duration ..... 652
  - Gate source ..... 652
  - Level value ..... 652
  - Peak power ..... 652
  - PEP ..... 652
  - Power value ..... 652
  - Progress ..... 651
  - Run mode ..... 653
  - Run status ..... 653
  - Signal source ..... 651
  - Sweep time ..... 652
- Measurement period ..... 156, 164
  - How long ..... 116
- MIMO ..... 84
  - Complex scenario ..... 106
  - Generate MxN scenario ..... 185
- MIMO scenario
  - Finding out the required settings ..... 183
  - How to set the system configuration ..... 185
- Min. version
  - Firmware ..... 1352
- Minimal frequency
  - Overrange ..... 484
- Minimum locking range ..... 495
- MISO scenario ..... 83
- Mode
  - Attenuator settings ..... 582
  - Automatic level control ..... 587
- Emulation ..... 837
- Fading and baseband configuration ..... 120
- FM ..... 561
- Frequency modulation ..... 561
- Graphics ..... 631
- I/Q out ..... 180
- IP address ..... 831
- List ..... 536
- LO coupling ..... 503
- Local oscillator ..... 503
- NRP power control ..... 607
- PhiM ..... 563
- PULM ..... 565
- Pulse modulation ..... 565
- RF level ..... 487
- Sweep ..... 528
- User variation ..... 485, 490
- Modulation
  - AM ..... 557
  - Amplitude ..... 557
  - Analog ..... 546
  - Bandwidth, external input ..... 574
  - External coupling ..... 574
  - FM ..... 557
  - Frequency ..... 557
  - Input impedance ..... 574
  - Overview ..... 578
  - Phase ..... 557
  - PhiM ..... 557
  - PM ..... 557
  - Pulse ..... 557
  - Source ..... 560
  - State (AM, FM, PhiM) ..... 559
- Modulation data
  - Source internal ..... 225
- Modulation depth
  - AM ..... 563
- Modulation sensitivity
  - AM ..... 563
- Modulation type ..... 276
- Modulations state
  - Toggle ..... 556
- Monitoring
  - Level ..... 650
  - Signal parameter ..... 622
- Mounting, in a rack ..... 30
- Mouse
  - Usage ..... 87
- MSR
  - 8 SISO ..... 104
- Multi carrier signal
  - General principle ..... 392
- Multi-carrier continuous wave signals ..... 408
- Multi-carrier CW
  - Subsystem ..... 1149
- Multi-entity mode ..... 85
- Multi-gated measurements ..... 659
- Multi-instrument setup
  - Simultaneous signal generation start ..... 667
  - Synchronous signals ..... 667
  - Time aligned signals ..... 667
- Multi-segment
  - Crest factor ..... 381
  - Multi-segment table ..... 370
- Multi-segment waveform
  - File contents ..... 369
- Multi-segment waveform sequencing ..... 361



- Multi-Standard Radio ..... 104
- Multicarrier waveforms ..... 391
- Multiple entities
  - SCPI alias ..... 896
- Multiple files
  - Copy ..... 719, 726, 728
- Multiplexed digital streams
  - Settings ..... 121
- Multiplier
  - Frequency ..... 483
- MxN MIMO ..... 185
- N**
- Naming contentions ..... 1383
- Naming conventions
  - Allowed file names ..... 699
- NavIC ..... 223
- Navigation keys ..... 43
- NDAC ..... 1395
- Near field communication ..... 223
- Network
  - Connection fails ..... 1345
  - Environment ..... 32
  - Settings ..... 830
- Network share
  - Mapping ..... 721, 723
- Network status ..... 830
- New list ..... 368
- New password
  - Setup (security) ..... 806
- New user password
  - Setup (security) ..... 805
- Next segment ..... 380
  - Mode ..... 380
  - Source ..... 381
- NFC A/B/F ..... 223
- Noise
  - Additive, generation ..... 424
  - Distribution ..... 575
  - Pure, generation ..... 424
- Noise bandwidth
  - 3 dB noise bandwidth ..... 358
  - AWGN ..... 440
  - To generate an AWGN test signal ..... 358
- Noise bandwidth limitation
  - System bandwidth ..... 575
- Noise generator
  - Bandwidth ..... 575
- Noise level
  - Absolute system bandwidth ..... 577
  - Relative system bandwidth ..... 577
- Noise only ..... 433
- Noise power
  - System bandwidth ..... 438
  - Total bandwidth ..... 439
- Noise ratio
  - Power sensors ..... 613
- Non-dedicated connectors ..... 743
- Notifications ..... 1341, 1344
  - Device-specific ..... 1342
- NRFD ..... 1395
- NRP level control
  - Measured level ..... 607
- NRP power control ..... 605
  - Catch range ..... 608
  - Delay time ..... 608
- Execute single ..... 608
- Mode ..... 607
- Reference level ..... 607
- Remote command sequence ..... 1265
- Select sensor ..... 607
- Settings ..... 606
- State ..... 607
- Take measured level as reference ..... 607
- Target level ..... 607
- NRP power viewer ..... 602
  - Settings ..... 604
  - Use S-Parameter ..... 614
- NRP sensor configuration ..... 610
- NRP sensor mapping ..... 615
  - Add LAN sensor ..... 616
  - Add sensor ..... 616
  - Add USBTMC sensor ..... 617
  - Clear ..... 616
  - Connector ..... 615
  - Device ID ..... 617
  - Host name ..... 616
  - IP address ..... 616
  - Protocol ..... 615
  - Scan ..... 616
  - Sensor name ..... 615, 617
  - Serial number ..... 617
  - Settings ..... 615
- NTP
  - Address ..... 1359
- Number of carriers ..... 395, 410
- Number of licenses ..... 1352
- Numeric data entry ..... 94
- Numeric values
  - Entering ..... 94
- O**
- Obtain technical support
  - Failed internal adjustments ..... 1347
- Occupation
  - Execute ..... 779
  - Free licenses ..... 779
  - Period ..... 779
  - Renew ..... 779
- Occupy
  - License info ..... 779
- Occupy license
  - Subsystem ..... 1260
- OFDM ..... 222
- Offset
  - Envelope, E ..... 181
  - Frequency ..... 482
  - I/Q out ..... 181
  - Inverted envelope, E BAR ..... 181
- Offset I/Q
  - Impairments ..... 454
- Old password
  - Setup (security) ..... 806
- Old user password
  - Setup ..... 805
- On-screen keypad ..... 91
- On/Off Ratio marker mode ..... 233
- Open source acknowledgment (OSA) ..... 26
- Open-source acknowledgments ..... 1352
- Operating site
  - Choosing ..... 28
  - Setting up the instrument ..... 29

- Operation
  - Concepts ..... 86
  - Manual ..... 87
- Operation complete
  - Remote ..... 900
- Operation hours ..... 1351
- Operation mode ..... 709
- Operation status register ..... 828
- Optimization mode ..... 470
  - RF ..... 470
- Optimize crest factor
  - Multicarrier ..... 396
- Optimizing I/Q modulation
  - General I/Q modulation tasks ..... 460
  - Improving the output signal quality ..... 465
  - Using optimization characteristics ..... 461
- Option
  - Expiration date ..... 1352
  - R&S SMW-K16 ..... 52
  - R&S SMW-K17 ..... 52
- Option: expiration date ..... 1352
- Options
  - ALC ..... 585
  - Analog modulation ..... 548
  - Identification (remote) ..... 900
  - Local oscillator ..... 501
  - see user manual ..... 80
- Oscillator
  - Adjust LO level ..... 504, 1369
  - Local ..... 500
  - Mandatory LO in frequency ..... 504
  - mode (local) ..... 503
  - Reference ..... 491
- Output
  - Baseband power ..... 651
  - SCPI list (select file) ..... 877
  - Source (LF output) ..... 576, 579
  - State (LO coupling) ..... 504
  - Video polarity (PULM) ..... 558
  - Video polarity (pulse modulation) ..... 558
- OUTPUT
  - Subsystem ..... 945
- Output connector ..... 44, 48, 49, 51, 52
- Output connectors
  - RF A/RF B ..... 45
- Output file ..... 368, 400
  - Multi-segment waveform ..... 362
- Output signal
  - Digital only ..... 121
- Output voltage, max
  - I/Q OUT ..... 117, 177
- Output, LF
  - Offset ..... 577
  - Voltage ..... 576
- Overflow
  - Avoid ..... 115, 158
  - Digital I/Q out ..... 174
  - External data remedy ..... 273
  - External signal ..... 115, 158
  - Hold ..... 158, 174
  - Received external data ..... 273
  - Reset ..... 174
- Overflow status
  - Reset ..... 158
- Overrange
  - Frequency range ..... 484
- Overrange active
  - Frequency ..... 484
- Oversampling factor ..... 308
- Overview
  - AM ..... 579
  - External RF and I/Q ..... 145
  - LF Out ..... 579
  - Modulation ..... 578
- P**
- Parallel poll register enable
  - Remote ..... 900
- Parity
  - RS232 interface ..... 835
- Password
  - Change (security password) ..... 806
  - Change (user password (security)) ..... 805
  - Confirm (security password) ..... 806
  - Confirm (user password (security)) ..... 805
  - Enter (security password) ..... 804
  - New (security password) ..... 806
  - New (user password (security)) ..... 805
  - Old (security password) ..... 806
  - Old user password ..... 805
  - Protection level ..... 800
- Password management
  - Security ..... 804
- Paste
  - Instrument settings ..... 721
- Pattern
  - Data source ..... 271
  - Standard modulation data source ..... 225
- PCI bus ..... 1350
- Peak power
  - BB Input ..... 157
  - Channel ..... 163
  - Digital output ..... 171, 173
- PEP
  - Carrier + Noise ..... 439
- Percentage of signal bandwidth
  - Graphics ..... 633
- Period
  - Blank segment ..... 372
- Periodical
  - Marker trace ..... 339, 351
- Periodical markers ..... 331
- Phase
  - First carrier ..... 413
  - RF signal ..... 490
  - Subsystem ..... 1263
- Phase between RF signals
  - How to minimize fluctuations ..... 663
- Phase modulation ..... 557, 562
  - Deviation ..... 562
  - Deviation mode ..... 562
  - Mode ..... 563
  - Ratio ..... 562
  - State ..... 559
  - Subsystem ..... 1046
- Phase offset ..... 421
  - Between the I/Q streams ..... 128
- Phase reference ..... 491
- Phase start ..... 404
- Phase step ..... 404, 413
- Phase-aligned RF signals
  - How to ..... 663

- Phase-coherent RF signals
  - How to ..... 663
- PhiM ..... 562
  - Deviation mode ..... 562
  - Mode ..... 563
  - Ratio ..... 562
  - see PhiM ..... 562
  - Total deviation ..... 562
- Ping
  - LXI ..... 857
- Placing, on a bench top ..... 29
- Plausibility check ..... 688
- Play list ..... 362, 368, 377, 382
- Play list file
  - Sequencing list file ..... 362
- Playlist
  - See play list ..... 362
- PM
  - Subsystem ..... 1046
- PN sequence
  - See PRBS ..... 225
- Polarity
  - Pulse generator output ..... 568
  - Pulse modulation ..... 559
- Position
  - Connector ..... 184
  - Cursor in graphical display ..... 287
- Power
  - Carrier + Interferer ..... 439
  - Carrier + Noise ..... 439
  - Connecting the instrument ..... 32
  - First carrier ..... 413
  - Signal + Interferer ..... 439
  - Signal + Noise ..... 439
  - UCOR ..... 593
- Power amplifiers testing
  - Envelope ..... 179
- Power of starting carrier ..... 404
- Power on
  - Key ..... 41
- Power ramp
  - Restrict to baseband ..... 282
- Power ramping ..... 229, 281
- Power reference ..... 398
- Power sensors
  - Activation ..... 611
  - Aperture time ..... 614
  - Auto once ..... 613
  - Filter ..... 612
  - Filter length ..... 613
  - Frequency ..... 612
  - Level (average) ..... 611
  - Level (peak) ..... 611
  - Level offset ..... 612
  - Noise ratio ..... 613
  - NRP power control ..... 605
  - Serial number ..... 611
  - Source ..... 612
  - State ..... 611
  - State (level offset) ..... 612
  - Timeout ..... 613
  - Unit ..... 611
  - Update ..... 604
  - Use default aperture time ..... 614
  - Zero ..... 611
- Power Sensors
  - Display ..... 611
  - Display permanent ..... 611
- Power spectrum ..... 627
- Power step ..... 413
- Power supply
  - Connector ..... 50
- Power viewer
  - Auto once ..... 613
- Power-On
  - Settings ..... 740
- Power-On count ..... 1351
- Power-On state
  - I/Q digital output ..... 175
  - RF level ..... 740
- Power-On/EMF
  - About ..... 740
  - RF signal ..... 740
- PRBS generator
  - Standard modulation data source ..... 225
- PRBS type ..... 271
- Prefix, year, month, Day ..... 734
- Preparing for use ..... 28
- Preset
  - Factory preset ..... 705
  - Fading configuration ..... 975
  - Ramp ..... 286
  - System configuration ..... 975
- Preview diagram ..... 119
- Primary-secondary
  - Sync signal state ..... 666
- Primary-secondary instrument mode
  - Assign signal ..... 666
  - Mode ..... 666
  - State ..... 666
- Print
  - Hard copy ..... 734
- Processing time ..... 240
- ARB ..... 318
- Protection
  - Settings ..... 799
  - Setup ..... 794
- Protection level
  - 1 ..... 794
  - 2 ..... 794
  - 3, 4, 5 ..... 794
  - Adjustments ..... 794
  - Calibration ..... 794
  - Factory only ..... 794
  - Protection level ..... 800
  - Service department ..... 794
- PULM
  - Delay ..... 568
  - Double pulse delay ..... 568
  - Double pulse width ..... 567
  - Impedance (pulse input) ..... 559
  - Mode ..... 565
  - Output video polarity ..... 558
  - Period ..... 567
  - Pulse polarity (input) ..... 559
  - Source ..... 558
  - State ..... 558
  - Subsystem ..... 1051
  - Threshold (pulse input) ..... 559, 756
  - Transition type ..... 558
  - Width ..... 567

- Pulse
  - Duty cycle ..... 572
  - Length (PULM) ..... 567
  - LF signal ..... 554
  - Period ..... 572
  - Width ..... 572
  - Width (PULM) ..... 567
- Pulse divider marker ..... 233
- Pulse frequency marker ..... 233
- Pulse generator
  - Delay ..... 568
  - Output polarity ..... 568
  - Output state ..... 568
  - Subsystem ..... 1262
  - Width ..... 567
- Pulse graph
  - Zoom In/Out ..... 570
  - Zoom position ..... 570
  - Zooming ..... 570
- Pulse modulation ..... 557
  - Double pulse delay ..... 568
  - Double pulse width ..... 567
  - Mode ..... 565
  - Output video polarity ..... 558
  - Period ..... 567
  - Pulse input impedance ..... 559
  - Pulse input threshold ..... 559, 756
  - Pulse polarity (input) ..... 559
  - Repetition frequency ..... 567
  - Source ..... 558
  - State ..... 558
  - Subsystem ..... 1051
  - Trigger mode ..... 565
- Purge
  - List of external instrument ..... 137
- Q**
  - Q offset ..... 451
  - QR code ..... 851
  - Quadrature offset
    - Impairments ..... 455
  - Quadrature Offset ..... 452
  - Quantified Licenses ..... 777
  - Questionable status register ..... 828
  - Quick recall ..... 712
  - Quick save ..... 711
  - Quick shift of the baseband signal
    - How to ..... 422
- R**
  - R&S DigiConf
    - Installing ..... 213
  - R&S EX-IQ-BOX
    - Connect ..... 213
    - Set up ..... 213
  - R&S SMW-K200 ..... 777
  - Rack installation ..... 48
  - Rack, mounting ..... 30
  - Ramp
    - All up or all down ..... 286
    - Low to high and vice versa ..... 286
  - Ramp function ..... 281
  - Ramp time ..... 281
  - Ratio
    - AM ..... 564
    - Amplitude modulation ..... 564
    - FM ..... 561
    - Frequency modulation ..... 561
    - Phase modulation ..... 562
    - PhiM ..... 562
  - Ratio noise/system bandwidth
    - Minimum ..... 434
  - Readjust
    - Automatic level control ..... 489
  - Reboot ..... 811
  - Recall
    - Instrument settings ..... 712
    - User menu ..... 768
  - Recall instrument settings ..... 901, 914
  - Recall intermediate ..... 901
  - Recorded SCPI commands
    - SCPI list ..... 876
  - Recording list
    - SCPI settings ..... 875
  - Rectangular test signal ..... 305
  - Rectangular test signals
    - Settings ..... 315
  - Redo ..... 810
    - Clear history ..... 811
    - History ..... 811
    - Settings ..... 811
    - State ..... 811
  - Reference curve
    - Show, hide, assign ..... 635
  - Reference frequency output
    - 1 GHz ..... 495
    - 10 MHz, 100 MHz ..... 495
    - Loop through ..... 495
  - Reference oscillator ..... 491
    - Adjustment ..... 496
    - Adjustment frequency ..... 496
    - External frequency ..... 493
    - Output frequency ..... 495
    - Reference frequency, variable ..... 494
    - RF off state ..... 493
    - Source ..... 492
    - Synchronization bandwidth ..... 494
  - Release notes ..... 26
  - Reload
    - SCPI list ..... 878
  - Remaining days ..... 778
  - Remote access ..... 816
    - Active connection settings ..... 838
    - Closed connection settings ..... 839
    - Configuring ..... 861
    - DNS server ..... 832
    - DNS suffix ..... 832
    - GPIB address ..... 834
    - GPIB resource (VISA resource string) ..... 834
    - HISLIP resource (VISA resource string) ..... 833
    - HUMS ..... 840
    - Identification ..... 837
    - IDN string ..... 838
    - IEC/ IEEE bus address ..... 834
    - Instrument emulations ..... 836
    - IP address mode ..... 831
    - Language ..... 837
    - Network gateway ..... 832
    - Network hostname ..... 831
    - Network IP address ..... 831

- Network Mac address ..... 832
- Network resource (Ethernet resource string) ..... 833
- Network settings ..... 830
- Network status ..... 830
- OPT string ..... 838
- QR code ..... 851
- RS232 ..... 835
- Serial resource (VISA resource string) ..... 834
- Set IDN and OPT to default ..... 837
- Settings ..... 829
- Socket resource (VISA resource string) ..... 834
- Subnet mask ..... 832
- USB resource (VISA resource string) ..... 834
- Visa resource strings settings ..... 833
- VXI11 resource (VISA resource string) ..... 833
- Workgroup name ..... 831
- Remote command list
  - Convert ..... 882
- Remote connection
  - Add floating license server ..... 789
  - Configure license server restrictions ..... 787, 788
  - Status ..... 133
- Remote control ..... 86
  - Access modes ..... 817
  - Command ..... 143
  - Command sequence ..... 143
  - Configure access ..... 861
  - External instrument ..... 194
  - GPIO ..... 871
  - GPIO interface ..... 822
  - History ..... 143
  - Interfaces and protocols ..... 818
  - IQ analog ..... 1212
  - IQ digital ..... 1212
  - Mode ..... 143
  - Programming examples ..... 898
  - Programs and libraries ..... 823
  - return to manual operation ..... 873
  - RF envelope ..... 1212
  - SCPI ..... 816
  - Setting up ..... 860
  - Source subsystem ..... 1005
  - Trace ..... 144
- Remote Desktop ..... 86
- Remote interfaces and protocols ..... 818
- Remote operation ..... 86
  - Stop access ..... 890
  - VNC ..... 816
- Remote to local switch over ..... 872
- Remote trace
  - LXI ..... 857
- Removing sensitive data ..... 1353
- REN ..... 1395
- Rename
  - File ..... 915
  - Instrument settings ..... 721
- Renew
  - Occupation ..... 779
- Reopen
  - Tutorial ..... 99
- Required system configuration
  - Basics ..... 102
- Resampling
  - External baseband signal ..... 116
- Reset
  - List mode ..... 538
  - RF frequency (delta phase) ..... 491
  - Sweep ..... 530
- Reset device parameters ..... 903
- Reset values
  - Remote ..... 901
- Resolution
  - Graphics ..... 632
- Resolving internal adjustment failures ..... 1346
- Resource string
  - RS232 ..... 821
  - USB ..... 821
  - VISA ..... 819
- Restart marker ..... 374
- Restoring configuration ..... 704
- Result
  - Connection selftest (BNC) ..... 1374
- Resulting file name ..... 734
- Retrace
  - Sweep ..... 528
- Retrigger
  - Common settings ..... 253
  - DM ..... 253
- Rev. A / Rev. B 1xEV-DO ..... 221
- RF
  - Signal ..... 475
- RF A/RF B
  - External RF and I/Q settings ..... 132
- RF A/RF B connector ..... 45
- RF adapter port ..... 1377
- RF couple
  - External RF and I/Q instrument ..... 134
- RF envelope ..... 179
- RF frequency
  - Configuring ..... 479
  - External RF and I/Q instrument ..... 135
- RF frequency sweep
  - State ..... 527
- RF frontend ..... 188
- RF hardware versions
  - Appendix ..... 1397
- RF level
  - Configuring ..... 479
  - Digital attenuation ..... 487
  - EMF display ..... 740
  - External RF and I/Q instrument ..... 135
  - Mode ..... 487
  - Offset ..... 489
  - PEP ..... 479
  - Power-On state ..... 740
  - Setting characteristics ..... 487, 533, 608
  - Settings ..... 485
- RF level sweep
  - State ..... 527
- RF OFF mode
  - Attenuator settings ..... 583
- RF off state
  - Reference oscillator ..... 493
- RF ON, RF OFF, RF ON/OFF ..... 478
- RF output
  - Amplitude ..... 486
  - Impedance ..... 478
  - PEP ..... 479
  - Protection ..... 584
  - State ..... 478

- RF Output
  - Level range ..... 535
- RF output signal
  - Phase ..... 490
  - Phase reference ..... 491
- RF path
  - External RF and I/Q ..... 140
- RF phase
  - Configuring ..... 479
- RF ports alignment ..... 679
- RF signal
  - Analog modulation ..... 546
  - Attenuator ..... 581
  - Automatic level control ..... 584
  - Frequency ..... 481
  - Phase ..... 490
  - Power-On/EMF ..... 740
  - User correction ..... 588
- RF state
  - External RF and I/Q instrument ..... 135
- Rise delay ..... 281
- RMS
  - Digital output ..... 171, 173
- RMS power
  - BB Input ..... 157
  - Channel ..... 163
- Roll off factor
  - DM ..... 279
- Rotary knob ..... 43
  - User variation ..... 485, 490
- Route to path A/B ..... 151
- RS232
  - Baud rate ..... 835
  - Interfaces ..... 821
  - Parity ..... 835
  - Remote access ..... 835
  - Resource string ..... 821
  - Serial (VISA resource string) ..... 834
  - Stop bits ..... 835
- Rx antennas
  - Fading and baseband configuration ..... 124
- S**
- S-Parameter
  - Activate corrections ..... 614
- S-parameter file
  - Ports ..... 695
- S-Parameter file
  - Exchange ..... 694
- Safety instructions ..... 19, 26
- Samba services
  - SMB client ..... 804
  - SMB server ..... 804
- SAMBA/SMB
  - How to access the instrument ..... 725
- Sample level
  - ALC ..... 588
  - Automatic level control ..... 588
- Sample rate
  - Aggregated ..... 163, 172
  - Channel ..... 163, 169, 171
  - Link ..... 163, 172
  - Source ..... 155, 161, 169
  - Value ..... 156
  - Where to find the value ..... 115
- Samples
  - Blank segment ..... 372
- Samples per period ..... 314
- Sanitize ..... 797
- save
  - Save ..... 709
- Save
  - Control list ..... 287
  - Editor ..... 543, 595
  - Instrument settings ..... 711
  - Sequencing list ..... 377
  - User menu ..... 768
- Save and load ..... 708
- Save as
  - Editor ..... 543, 595
- Save hard copy as
  - bmp, jpg, png ..... 732, 733
- Save instrument settings ..... 901, 916
- Save intermediate ..... 901
- Save list ..... 368
- Save/Recall ..... 395, 708
  - Dialog ..... 709
  - Digital standard ..... 709
  - DM ..... 269
  - Firmware option settings ..... 709
  - How to ..... 712
  - I/Q output analog ..... 179
  - SCPI-Export ..... 880
- Saving
  - Trying out ..... 70
- Saving files ..... 906
- SBAS ..... 223
- Scan
  - For external instrument ..... 137
  - NRP sensor mapping ..... 616
- Scenario
  - 1x4x4 MIMO ..... 185
  - Single entity with 4x4 MIMO ..... 185
- SCONfiguration subsystem ..... 963
- SCPI
  - Error messages ..... 1342
  - Export ..... 718
  - Export settings ..... 876
  - Import ..... 718
  - LAN services ..... 802
  - Output file ..... 877
  - Recording list settings ..... 875
- SCPI export ..... 878
  - File content ..... 878
  - Select file ..... 877
- SCPI Export
  - Format ..... 877
- SCPI list
  - Commands of all settings ..... 711
  - Export ..... 876
  - Recorded SCPI commands ..... 876
  - Show all commands ..... 711
- SCPI recording
  - Settings ..... 874
- SCPI remote trace
  - LXI ..... 857
- SCPI script
  - Select ..... 770
- SCPI sequence
  - Send to external instrument ..... 194
- SCPI-Export
  - Save/Recall ..... 880

- Screen saver
  - Activate ..... 741
  - State ..... 738
  - Wait time ..... 738
- Security
  - Accept settings ..... 804
  - Change password (setup) ..... 806
  - Change user password (setup) ..... 805
  - Confirm password (setup) ..... 806
  - Confirm user password (setup) ..... 805
  - Disk & memory settings ..... 795
  - Display lock ..... 798
  - Enter password (setup) ..... 804
  - Manual operation settings ..... 797
  - New password (setup) ..... 806
  - New user password (setup) ..... 805
  - Old password (setup) ..... 806
  - Old user password ..... 805
  - Password management ..... 804
  - Sanitize ..... 797
  - Security password ..... 806
  - Setup ..... 794
  - USB storage (setup) ..... 796
  - User name (setup) ..... 805
  - User password ..... 805
  - Volatile memory ..... 796
- Security password
  - Security ..... 806
  - Setup ..... 806
- Security procedures ..... 26
- Security settings ..... 794
- Segment # ..... 370
- Segment down ..... 371, 379
- Segment marker ..... 374
- Segment up ..... 371, 379
- Select
  - List mode data file ..... 539
  - Setup file ..... 770
  - User correction data file ..... 593
- Select file ..... 717
- Select free licenses
  - Occupation ..... 779
- Select instrument
  - External RF and I/Q ..... 138
- Select period
  - Occupation ..... 779
- Select row
  - Editor ..... 543, 595
- Self-calibration routines
  - About ..... 1357
- Self-test
  - About ..... 1357
  - Remote ..... 902
- Selftest
  - ARB file (test generator) ..... 1376
  - Connection selftest (BNC) ..... 1373
  - Destination ..... 1374
  - Execute (baseband) ..... 1374
  - Frequency (test generator) ..... 1376
  - Gain (test generator) ..... 1376
  - Result ..... 1374
  - Source ..... 1373
  - Source (test generator) ..... 1375
  - State (test generator) ..... 1375
- Sensitive information
  - Protecting ..... 700, 707
- Sensor
  - NRP power control ..... 607
- Sensor name
  - NRP sensor mapping ..... 617
- Sequencing graph ..... 379
- Sequencing list ..... 368, 377, 382
  - Load ..... 376
  - New ..... 376
- Serial
  - Visa resource string ..... 834
- Serial bus ..... 1350
- Serial data, extern
  - LSB ..... 274
  - MSB ..... 274
- Serial number ..... 863
  - NRP sensor mapping ..... 617
  - Power sensors ..... 611
- Service manual ..... 25
- Service request enable register (SRE)
  - Remote ..... 902
- Services
  - LAN ..... 800
- Set according to ..... 269
- Set connector default settings
  - Global connectors ..... 568
- Set IDN and OPT to default
  - Emulation mode ..... 837
- Set level via
  - Digital output ..... 173
- Set noise level via ..... 436
- Set to default ..... 395
  - ARB ..... 311
  - DM ..... 268
  - Fading and baseband configuration ..... 126
  - MCCW ..... 410
- Set up
  - R&S EX-IQ-BOX ..... 213
- Set up remote control
  - GPIB ..... 871
- Setting up
  - remote control ..... 860
- Settings
  - Active connections ..... 838
  - Appearance ..... 739
  - Attenuator ..... 582
  - Automatic level control ..... 586
  - Check front panel ..... 1361
  - Closed remote connections ..... 839
  - Delayed adjustment ..... 1370
  - Display ..... 737
  - FM ..... 560
  - Instrument emulations ..... 836
  - Internal adjustments ..... 1368
  - Keyboard ..... 737
  - Licenses ..... 773
  - List mode ..... 535
  - Local oscillator ..... 502
  - Managing ..... 699
  - NRP power control ..... 606
  - NRP power viewer ..... 604
  - NRP sensor mapping ..... 615
  - On power-on ..... 740
  - Protection ..... 799
  - Remote access ..... 829
  - RF level ..... 485
  - SCPI export ..... 876
  - SCPI recording ..... 874

- SCPI recording list ..... 875
- Security ..... 795, 797
- Show SCPI command ..... 875
- UCOR ..... 592
- Undo/Redo ..... 811
- User key ..... 769
- Setup
  - Accept security settings ..... 804
  - Adjusting display ..... 736
  - Adjusting keyboard ..... 736
  - Annotation frequency ..... 798
  - Annotation level ..... 798
  - Appearance settings ..... 739
  - Calibrate (touchscreen) ..... 1361
  - Change password ..... 805
  - Change password (security) ..... 806
  - Confirm password ..... 805
  - Confirm password (security) ..... 806
  - Dialog overview ..... 812
  - Display lock ..... 798
  - Enter password (security) ..... 804
  - GUI update ..... 736
  - Keyboard settings ..... 737
  - Layout (front panel keyboard) ..... 739
  - Layout (USB keyboard) ..... 738
  - Load file ..... 682
  - New password ..... 805
  - New password (security) ..... 806
  - Old password (security) ..... 806
  - Password (protection) ..... 800
  - Performing the front panel test ..... 1361
  - Protection level ..... 800
  - Screen saver ..... 738
  - Security password ..... 806
  - Test (touchscreen) ..... 1361
  - USB storage (security) ..... 796
  - User name (security) ..... 805
  - User password ..... 805
  - Wait time ..... 738
- Setup control
  - External instrument ..... 194
- Setup description
  - Where to find information ..... 812
- Setup files
  - Data exchange ..... 730
- SETUP key ..... 736
- Shape
  - Analog modulation ..... 554
  - LF generator ..... 572
  - LF output ..... 572
  - Period ..... 572
  - Pulse duty cycle ..... 572
  - Pulse width ..... 572
  - Sweep ..... 528
  - Trapeze high ..... 573
  - Trapezoid rise, fall ..... 573
  - Triangle rise ..... 573
- Shared connectors
  - Global connectors ..... 743
- Shifting the baseband signal ..... 418
- Show
  - SCPI list ..... 711
- Show powers for output
  - AWGN ..... 435
- Show SCPI command
  - Close ..... 875
  - Copy ..... 875
  - Settings ..... 875
- Shut down ..... 811
- Signal + Interferer
  - PEP ..... 439
- Signal + Noise
  - PEP ..... 439
- Signal duration ..... 397
- Signal generation status ..... 254
- Signal monitoring
  - Graphical display ..... 622
- Signal output
  - LF ..... 575
- Signal outputs
  - Fading and baseband configuration ..... 121
- Signal period mode ..... 397
- Signal power ..... 437
- Signal routing
  - Baseband ..... 148, 151
  - Fading ..... 149
  - Fading and baseband configuration ..... 122
  - Settings ..... 147
  - Standard mode only ..... 149
- Signal routing setting
  - Overview of the possible ways ..... 105
- Signal routing settings
  - Baseband ..... 105
  - Fading ..... 105
  - Overview and basics ..... 105
- Signal shape
  - Analog modulation ..... 554
  - Pulse ..... 554
  - Trapezoid ..... 554
  - Triangle ..... 554
- Signal source
  - Analog modulation ..... 549
  - External (analog modulation) ..... 549
  - Internal (analog modulation) ..... 549
- Signal to connector mapping
  - How to ..... 760
- Signal/Noise ratio ..... 437
- Signals
  - Trigger/Marker/Clock ..... 745
- Simultaneous baseband signals
  - Inside the R&S SMW200A ..... 261
- Simultaneous signal generation start
  - Coupled trigger settings ..... 243
  - In all basebands ..... 243
  - Several instruments ..... 667
- Sine test signal ..... 305
- Sine test signals
  - Settings ..... 314
- Single
  - Common settings ..... 253
  - DM ..... 253
  - Execute (list mode) ..... 538
- Single sideband signal
  - Generation ..... 416
- Slow IQ signals
  - Settings ..... 121
- SMB (Samba)
  - LAN services ..... 802
- Snapshots
  - Dialog ..... 739



- Socket
  - Visa resource string ..... 834
- Softkey bar
  - See Taskbar ..... 90
- Software options ..... 80
- Solid-state drive ..... 49
- Source
  - AM, FM,  $\Phi$ M ..... 560
  - Analog modulation ..... 549
  - Baseband power ..... 651
  - Connection selftest (BNC) ..... 1373
  - External digital signal ..... 154, 160
  - Graphics ..... 631
  - LF output ..... 576, 579
  - Power ramp control ..... 281
  - Power sensors ..... 612
  - Pulse modulation ..... 558
  - Reference oscillator ..... 492
  - Sweep trigger ..... 528
  - Test generator selftest ..... 1375
- Source points for graphic display ..... 627
- Source subsystem
  - Remote control commands ..... 1005
- Source, multiplexed
  - Graphics ..... 632
- Spacing
  - Frequency sweep ..... 529, 531
  - RF frequency / level sweep ..... 529, 531
  - RF level sweep ..... 533
- Span
  - Frequency sweep ..... 531
- Specifications ..... 26
- Specified trigger delay ..... 257
- Spectrum display ..... 627
- SRQ ..... 1395
- SSB
  - Generation ..... 416
- SSH
  - LAN services ..... 802
- Standard ..... 269
- Standard settings ..... 395, 410
  - DM ..... 268
- Standard-compliant signals ..... 220
- Standby
  - Key ..... 41
- Start
  - Frequency sweep ..... 531
  - RF level sweep ..... 533
- Start carrier index ..... 404
- Start delay ..... 405
- Start phase ..... 404
- Starting gain ..... 404
- Starting the signal generation with the first sample ..... 240
- State ..... 681
  - Adjustment (reference oscillator) ..... 496
  - AM, FM,  $\Phi$ iM ..... 559
  - ARB ..... 311
  - Automatic level control ..... 586
  - AWGN ..... 432
  - BB Input ..... 154, 160
  - Carrier (MCCW) ..... 413
  - DM ..... 268
  - I/Q digital output ..... 168
  - I/Q modulation ..... 468
  - Impairments ..... 454
  - LF frequency sweep ..... 527, 572
  - List mode ..... 536
  - MCCW ..... 410
  - NRP power control ..... 607
  - Power sensors ..... 611
  - PULM ..... 558
  - Pulse generator output ..... 568
  - Pulse modulation ..... 558
  - RF frequency sweep ..... 527
  - RF level sweep ..... 527
  - RF output ..... 478
  - RF output protection ..... 584
  - Screen saver ..... 738
  - Test generator selftest ..... 1375
  - UCOR ..... 592
  - Undo/Redo ..... 811
- Status
  - Remote connection to external RF and I/Q ..... 133
- Status bar
  - Display ..... 88
- Status byte
  - Remote ..... 899, 902
- Status information ..... 776
- Status register
  - Response format definition ..... 938
- Status reporting system ..... 826
  - Common commands ..... 898
  - Overview of status registers ..... 826
- Status settings
  - LXI ..... 851
- Step
  - Frequency sweep ..... 532
  - Linear (frequency sweep) ..... 532
  - Logarithmic (frequency sweep) ..... 532
  - RF level sweep ..... 533
- Step width
  - User variation ..... 485, 490
- Stop
  - Frequency sweep ..... 531
  - RF level sweep ..... 533
  - Tutorial ..... 99
- Stop bits
  - RS232 interface ..... 835
- Stop carrier index ..... 404
- Stopping remote operation ..... 890
- Storage ..... 1357
- Storage location
  - /usb/ ..... 699
  - /var/user ..... 699
  - /var/volatile ..... 699
  - Mass memory ..... 905
- Stream
  - Coupling ..... 430
  - Number of ..... 124
- Stream distributing
  - Settings ..... 128
- Stream extender ..... 125
- Stream mapping
  - Default ..... 107
  - Rule ..... 107
  - Settings ..... 128
- Subnet mask ..... 832
- Subset ..... 124
- Subsystem
  - AM ..... 1037
  - FM ..... 1041
  - Keyboard ..... 944
  - Occupy license ..... 1260
  - OUTPUT ..... 1006

- Phase ..... 1263
- PM ..... 1046
- Power ..... 1264
- PULM ..... 1051
- Pulse generator ..... 1262
- SOURce:INPut ..... 1006
- Sum signal
  - How to shift basebands ..... 422
- Support ..... 1353
- Suppressing
  - Carrier leakage ..... 422
- Surveillance
  - Signal generation ..... 622
- Swap
  - Digital input signals ..... 154, 160
- Sweep
  - Center frequency ..... 531
  - Current frequency ..... 527
  - Current level ..... 527
  - Dwell time ..... 529
  - Execute single ..... 530
  - Frequency span ..... 531
  - Mode ..... 528
  - Reset ..... 530
  - Retrace ..... 528
  - Shape ..... 528
  - Spacing ..... 529, 531, 533
  - Start/stop frequency ..... 531
  - Start/stop level ..... 533
  - State (LF frequency) ..... 527, 572
  - State (RF frequency) ..... 527
  - State (RF level) ..... 527
  - Step ..... 532, 533
  - Trigger manually ..... 530
- Switch over
  - Flexible ..... 384
  - High speed ..... 385
- Switching
  - Modulation to CW ..... 278
  - On or off ..... 37
- Symbol rate
  - DM ..... 269
- Symbolic name
  - External RF and I/Q ..... 138
- Sync. Output to external trigger ..... 256
- Sync. Output to trigger ..... 256
- Synchronization
  - Assign signal ..... 666
  - Mode ..... 666
  - State ..... 666
  - Sync signal state ..... 666
- Synchronization bandwidth
  - Reference oscillator ..... 494
- Synchronize
  - External RF and I/Q instrument ..... 134
- Synchronizing
  - Several instruments ..... 664
  - Signal generation ..... 678
- Synchronizing instruments
  - How to ..... 663
- Synchronous generation start
  - External global trigger/clock ..... 236
- System
  - Factory preset ..... 705
- System bandwidth
  - AWGN ..... 433
  - Noise level (absolute) ..... 577
  - Noise level (relative) ..... 577
- System configuration
  - Advantages ..... 106
  - Basics ..... 106
  - General workflow ..... 100
  - MxN MIMO ..... 106
  - Preset ..... 975
- System drive
  - Solid state, SSD ..... 49
- T**
  - t\_hold
    - Extern serial data ..... 226
  - t\_setup
    - Extern serial data ..... 226
  - T/M connector
    - Trigger/Marker ..... 745
  - T/M(C) connector
    - Trigger/Marker/(Clock) ..... 745
  - Tab labels ..... 91
  - Tag type ..... 347
    - Clock ..... 339
    - Comment ..... 338
    - Control length ..... 339, 351
    - Control list width4 ..... 349
    - Copyright ..... 338
    - Data bit length ..... 350
    - Data list ..... 350
    - Date ..... 338
    - Emptytag length ..... 340
    - Level offset ..... 341
    - Magic ..... 337
    - Marker mode ..... 342
    - Samples ..... 343
    - Segment clock mode ..... 347
    - Segment comment ..... 349
    - Segment count ..... 346
    - Segment duration ..... 346
    - Segment files ..... 349
    - Segment length ..... 346
    - Segment level mode ..... 347
    - Segment level offset ..... 348
    - Segment start ..... 346
    - Settings file ..... 348
    - Trace list ..... 343, 352
    - Waveform length ..... 344
  - Take measured level as reference
    - NRP power control ..... 607
  - Tapping points ..... 627
  - Target crest factor ..... 396
  - Target level
    - NRP power control ..... 607
  - TD-LTE ..... 102
  - TD-SCDMA ..... 221
  - Temperature offset
    - Internal adjustments ..... 1369
  - Temporary files ..... 700, 707
  - Test
    - Check front panel ..... 1361
  - Test case
    - Finding out the required settings ..... 183
    - How to set the system configuration ..... 183

- Test signal
    - Amplitude of test signal ..... 316
    - ARB generator ..... 305
    - Frequency ..... 314, 316
    - Offset DC ..... 316
    - Phase offset Q ..... 315
    - Samples per period ..... 314, 316
    - Value I, Q ..... 317
  - Testing
    - High-power amplifiers ..... 406
  - TETRA Release 2 ..... 220
  - Text entry ..... 94
  - Threshold
    - Pulse modulation ..... 559, 756
  - Throughput delay
    - Extern serial data ..... 274
  - Time
    - UTC ..... 1359
  - Time protocol
    - Settings ..... 1359
  - Time-based trigger
    - State ..... 254
  - Timeout
    - Filter (power sensors) ..... 613
  - Timing
    - External data ..... 275
  - Tooltips
    - Show ..... 95
  - Touch panel
    - see Touchscreen ..... 1362
  - Touch screen
    - see Touchscreen ..... 1362
  - Touchscreen
    - Adjusting ..... 1362
    - Alignment ..... 1362
    - Calibrate ..... 1361
    - Calibration ..... 1362
    - Compared with mouse ..... 87
    - Overview ..... 39
    - Test ..... 1361
    - Usage ..... 87
  - Touchscreen calibration
    - Check front panel ..... 1362
  - Touchscreen test
    - Perform ..... 1364
  - Trace
    - Enable in graphic ..... 635
  - Tracing
    - Messages ..... 864
    - SCPI commands ..... 864
  - Tracking
    - Signal parameter ..... 622
  - Transition
    - PULM ..... 558
    - Pulse modulation ..... 558
  - Transmitter test
    - Generating a multi carrier signal ..... 406
  - Transporting ..... 1356
  - Trapezoid
    - High (LF generator) ..... 573
    - LF signal ..... 554
    - Rise, fall ..... 573
  - Trial license table ..... 778
  - Trial licenses ..... 771
  - Trial period ..... 778
  - Triangle
    - LF signal ..... 554
    - Rise ..... 573
  - Trigger
    - Event (remote) ..... 902
    - Execute ..... 756
    - Execute (list mode) ..... 538
    - Generate signal manually ..... 754
    - Manually ..... 754
    - Sweep, manually ..... 530
  - Trigger box ..... 678
  - Trigger delay
    - Actual ..... 257
    - Expressed in seconds ..... 257
    - Expressed in time ..... 256
    - Resulting ..... 257
    - Unit ..... 256
  - Trigger Delay
    - DM ..... 257
  - Trigger event
    - Delay ..... 241
    - Suppress ..... 241
  - Trigger example ..... 382
  - Trigger local connector
    - see T/M(C) and T/M ..... 745
  - Trigger Mode
    - Common settings ..... 253
    - DM ..... 253
  - Trigger settings
    - Common to all basebands ..... 750
  - Trigger signal duration ..... 257
  - Trigger signals
    - Baseband ..... 235
  - Trigger source
    - DM ..... 255
    - Graphics ..... 632
    - List mode ..... 536
    - Sweep ..... 528
  - Trigger, accidental
    - Avoiding ..... 240
  - Triggering
    - All basebands ..... 261
    - Basebands simultaneous ..... 243
    - Multi-segment waveform ..... 363
    - Segment ..... 363
    - Time-based ..... 263
  - Triggering synchronous ..... 678
  - Triggering synchronous the basebands ..... 236
  - Tripped
    - RF output protection ..... 584
  - Tutorial ..... 95
  - Tutorials ..... 25
    - How to open ..... 97
  - Tx antennas
    - Fading and baseband configuration ..... 123
- ## U
- UCOR
    - About ..... 589
    - Calibrate RF output level with power sensor ..... 617
    - Data ..... 593
    - Data editor ..... 593
    - Display correction file data ..... 593
    - Display correction value ..... 593
    - Edit data ..... 593
    - Export user data ..... 541, 600

- File catalog ..... 593
  - File settings, import/export ..... 541, 599
  - Fill with sensor ..... 597
  - Import/export ..... 540, 599
  - Load from file ..... 541, 599
  - RF signal ..... 588
  - Select file ..... 593
  - Settings ..... 592
  - State ..... 592
  - Underflow
    - External data remedy ..... 273
  - Undo ..... 810
    - Clear history ..... 811
    - History ..... 811
    - Settings ..... 811
    - State ..... 811
  - Units X-axis
    - Change ..... 635
  - Unmodulated signal ..... 229
  - Unpacking the instrument ..... 28
  - Up-conversion
    - Important parameters ..... 114
  - USB
    - Interfaces ..... 821
    - Resource string ..... 821
    - Storage (security) ..... 796
    - Visa resource string ..... 834
  - Use default aperture time
    - Power sensors ..... 614
  - User clock ..... 374
  - User correction
    - see UCOR ..... 588
  - User correction
    - Data editor ..... 593
  - User data
    - Access ..... 714
    - Load from a specific directory ..... 907
  - User files ..... 699
  - User filter
    - Catalog ..... 280
    - Delete ..... 280
  - User interface
    - Front panel keyboard ..... 739
    - Lock ..... 798
  - User key ..... 763
    - Action name ..... 769
    - Add, change, delete action ..... 770
    - Assign actions ..... 767
    - Define action ..... 769, 770
    - SCPI command ..... 770
    - Select dialog ID ..... 770
    - Settings ..... 769
    - Toggle between define and execute mode ..... 770
  - User manual ..... 25
  - User mapping
    - Catalog ..... 276
    - Delete ..... 276
  - User menu ..... 763
    - Access ..... 765
    - Clear ..... 768
    - Create ..... 765
    - Recall ..... 768
    - Save ..... 768
    - Settings ..... 768
  - User name
    - Setup (security) ..... 805
  - User password
    - Security ..... 805
    - Setup ..... 805
  - User preset ..... 704
  - User variation
    - Activating ..... 485, 490
    - Digital I/Q out ..... 174
    - Level ..... 485, 490
    - RF ..... 485, 490
  - User-definable preset
    - Recall ..... 764
  - Utility keys
    - Overview ..... 41
- ## V
- Value
    - Sample rate ..... 169
  - Variable FSK
    - Deviation ..... 277
    - Selecting ..... 277
  - Variable reference frequency ..... 494
  - Varying
    - RF frequency and level ..... 485, 490
  - Vector diagram ..... 623
  - Vector modulation ..... 458, 466
  - Verifying
    - Signal parameter ..... 622
  - Version
    - Firmware ..... 1351
  - Video polarity
    - Pulse modulation ..... 558
  - Videos ..... 27
  - VISA ..... 819
    - Resource string ..... 819
  - Visa resource string
    - Ethernet ..... 833
    - GPIB ..... 834
    - HISLIP ..... 833
    - Serial ..... 834
    - Socket ..... 834
    - USB ..... 834
    - VXI11 ..... 833
  - Visa resource strings ..... 833
  - VNC ..... 86
    - How to enable ..... 885
    - LAN services ..... 802
  - Volatile memory ..... 700, 707
  - Volatile mode
    - Activate ..... 796
  - VXI11
    - Visa resource string ..... 833
- ## W
- Wait
    - Remote ..... 903
  - Wait time
    - Screen saver ..... 738
  - Wanted signal
    - Use an external digital signal ..... 112
  - Warnings ..... 1341, 1344
  - Waveform
    - Common for all basebands ..... 311
    - Edit, rules ..... 335
    - Info ..... 312, 370
    - Load file ..... 312

Maximum length .....	308
Optimizing .....	308
Per baseband .....	311
Waveform file	
Corrupted, reasons .....	335
Web interface .....	86
What's new .....	24
White papers .....	26
Wi-Fi	
WLAN .....	888
Width	
Double pulse (PULM) .....	567
PULM .....	567
Pulse modulation .....	567
Wireless connectivity standards .....	221
Wireless LAN standards .....	221
WLAN standards .....	221
Workflow	
Connecting external instruments .....	100
Multi-segment waveform .....	382
System configuration .....	100
Workgroup name .....	831
Wrap-around	
Avoiding problems .....	392
Overcome the problem .....	384
<b>Z</b>	
Zero	
Power Sensors .....	611
Zeroconf	
IP address .....	1345
Zoom	
Control list display .....	287
Zoom In/Out	
Pulse graph .....	570
Zoom position	
Pulse graph .....	570
Zooming	
Pulse graph .....	570